



Irrigation Catalog



**We are your one stop source for
all your Irrigation needs.**



WWW.IRRIGATIONDISTRIBUTORS.COM

We are Your 1 Stop Shop for A



Our Pledge of Support & Commitment

Service:

We will provide you with the best service available in the industry. Specializing in same day response to your needs. We will always provide the best and most complete service package available from any supplier.

Quality:

We will always strive to provide you with the highest quality name brand products in the industry, backed with the manufacturer's guarantee and warranty.

Pricing:

We will continually work to provide you with the lowest and most competitive prices in the industry. In many cases, we will be able to extend "factory direct pricing," the same that you would be able to purchase at direct from the manufacturer. In every case, we will provide fair and competitive prices for all of your irrigation needs.



All Your Irrigation Needs!

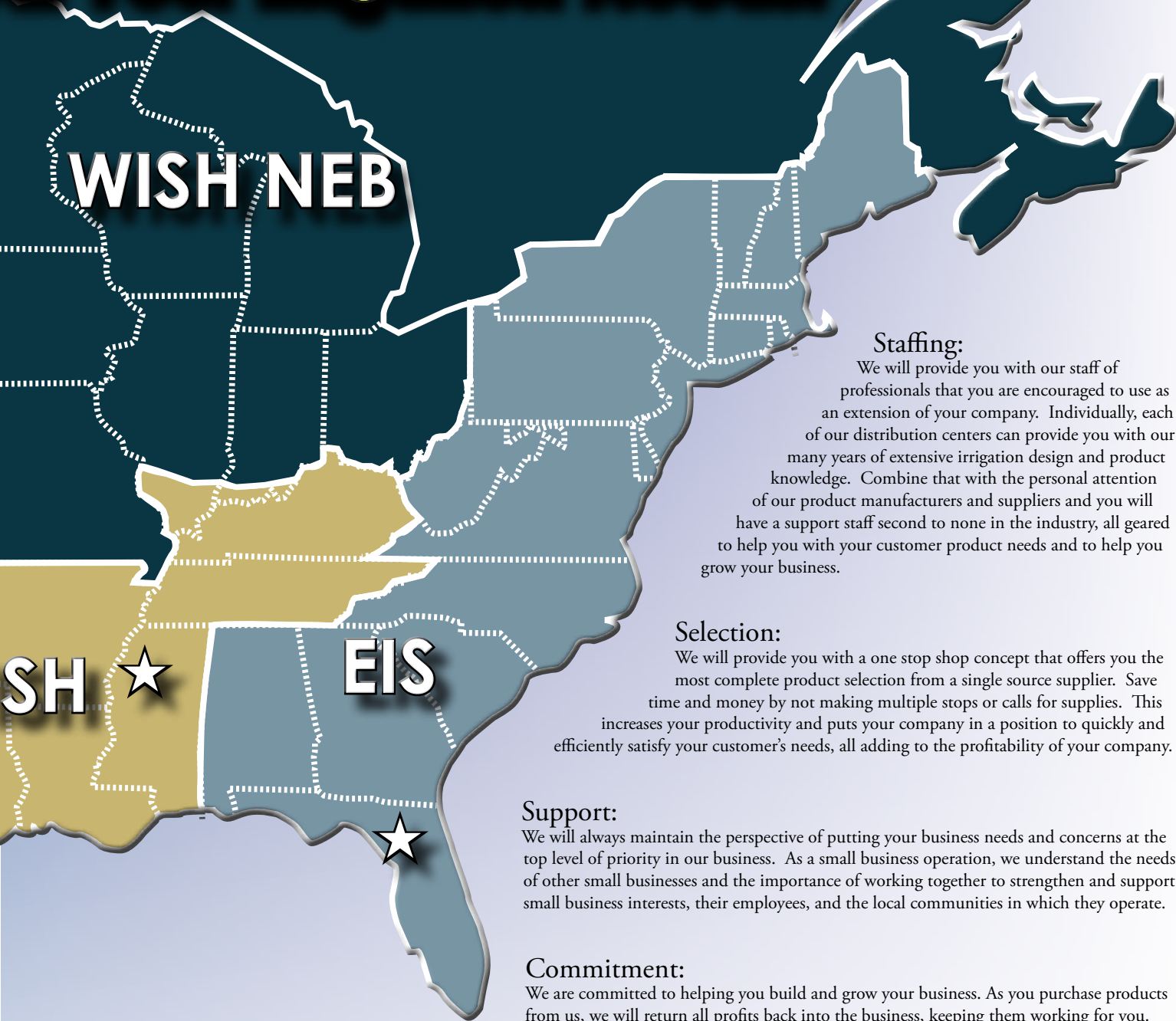

Staffing:

We will provide you with our staff of professionals that you are encouraged to use as an extension of your company. Individually, each of our distribution centers can provide you with our many years of extensive irrigation design and product knowledge. Combine that with the personal attention of our product manufacturers and suppliers and you will have a support staff second to none in the industry, all geared to help you with your customer product needs and to help you grow your business.

Selection:

We will provide you with a one stop shop concept that offers you the most complete product selection from a single source supplier. Save time and money by not making multiple stops or calls for supplies. This increases your productivity and puts your company in a position to quickly and efficiently satisfy your customer's needs, all adding to the profitability of your company.

Support:

We will always maintain the perspective of putting your business needs and concerns at the top level of priority in our business. As a small business operation, we understand the needs of other small businesses and the importance of working together to strengthen and support small business interests, their employees, and the local communities in which they operate.

Commitment:

We are committed to helping you build and grow your business. As you purchase products from us, we will return all profits back into the business, keeping them working for you.

Whether it be through maintaining adequate stock levels which make it possible to address your customer's needs, selecting new products for you to offer your customers and grow from, or negotiating better prices from manufacturers to lower your cost, we are committed to you.





EASTERN IRRIGATION SUPPLY, INC.

Eastern Irrigation Supply, Inc.
5328 NW State Road 45
Newberry, FL 32669-1089
Phone: 352-472-3323
Fax: 352-472-2830
Email: eis@irrigationdistributors.com

Eastern Irrigation Supply, Inc., is a premier irrigation supply center with large and diverse product offering for agriculture, commercial, industrial and residential applications. If your needs include accessories for pump, pipeline, pivot, sideroll, solid set, turf, micro irrigation or traveler replacement parts, there is a good chance that we inventory or have at our disposal the products that will meet your needs.

Presently, EIS represents over 100 of the top manufacturers and suppliers in the industry, whose products we distribute throughout a large portion of the United States, from Puerto Rico to Maine.

Our goal at EIS is to give you the best service possible by having inventory on hand, prompt delivery once an order is received and competitive prices to enhance your position in the market. We also pledge to give technical support if or when you need it.

We genuinely appreciate and thank you for your business.

Where We're Located

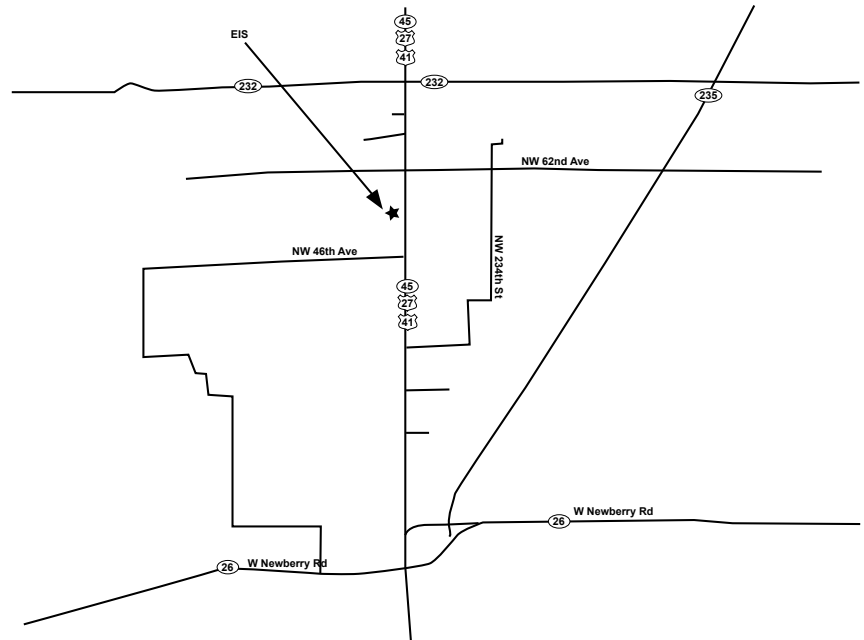



**EQUIPMENT
SUPPLY
CO., INC.**

LUBBOCK, TX / DUMAS, TX

Equipment Supply Co., Inc.

**2224 Marshall Street
Lubbock, TX 79415**

Phone: 806-747-0004 800-900-9975

Fax: 806-747-2706

Email: escosales@irrigationdistributors.com

Equipment Supply Co., Inc. (ESCO), was incorporated and opened for business in Lubbock, Texas in November 1986. To better service the needs of our customers in the Panhandles of Texas and Oklahoma, a second warehouse was constructed and opened in March 2012.

Presently, ESCO represents more than 100 of the top manufacturers and suppliers in the industry, whose products we distribute throughout Arizona, New Mexico, and portions of Texas, Oklahoma and Mexico.

Considering both inventory volume and diversity of product in stock, ESCO ranks among the top distributors in the country. Specializing in same day service, ESCO has what you want, when you need it. Hands down, ESCO is your Irrigation Supply Center of the Southwest.

We are three blocks east of University Avenue on Marshall Street just east of Buddy Holly Park in north Lubbock. From North Loop 289, take the University Avenue exit and go south to Marshall Street. Just turn east onto Marshall Street, and we're 3 blocks down on the north side of the street.

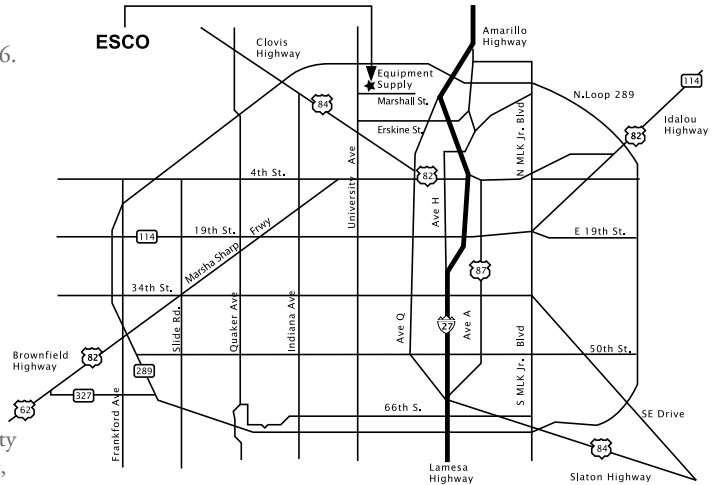

ESCO / DUMAS

416 Success Blvd.

Dumas, TX 79029

Phone: 806-935-0004 855-824-9461

Fax: 806-935-0008

Email: dumas@irrigationdistributors.com



INTRO
1. ELECTRICAL
2. PUMP Acc.
3. HOSE, PE PIPE & Acc.
4. IPS, PIP Pipe & Acc.
5. SURFACE
6. SPRINKLERS
7. TRAVELER & WHEEL MOVE
8. PIVOT
9. TURF
10. LOW VOLUME
11. FILTERS
12. INJECTION
13. HARDWARE
INDEX

SWiSH Inc.

SWISH Inc.
 970 CR 351
 Stephenville, TX 76401
 Phone: 254-965-4505
 Fax: 254-968-4075
 SWISH@IrrigationDistributors.com

SWISH, Inc., was incorporated and opened for business in Stephenville, Texas in November 1982. In 2009, in order to better serve our customers we opened the SWISH Inc. Southeast Warehouse in Mississippi.

Presently, SWISH represents over 100 of the top manufacturers and suppliers in the industry, whose products we distribute throughout Arkansas, Louisiana, Tennessee, Kentucky, Mississippi, and portions of Texas, Oklahoma, Mexico, Illinois, and Indiana.

SWISH Inc. now has 2 locations to better serve you.



SWISH Inc. Southeast Warehouse

132 Porter Street
 Senatobia, Ms 38668
 Phone: 662-301-1190
 Fax: 662-301-1192
 SWISH_SE@IrrigationDistributors.com

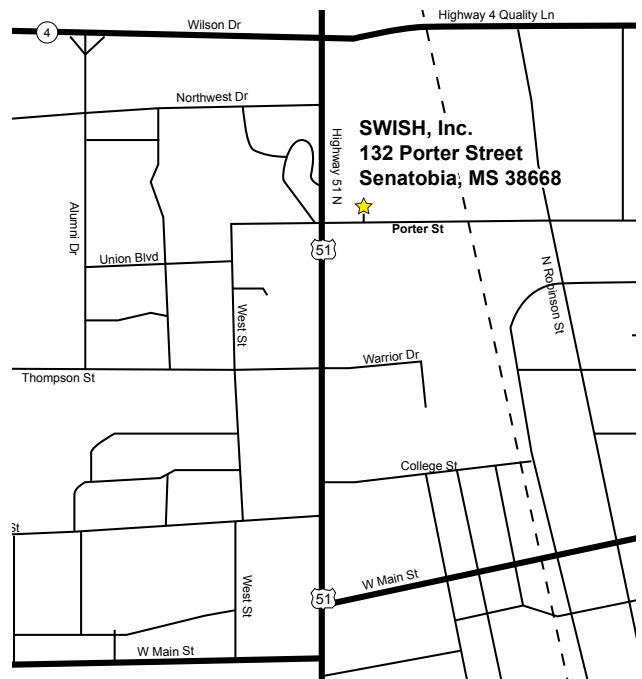
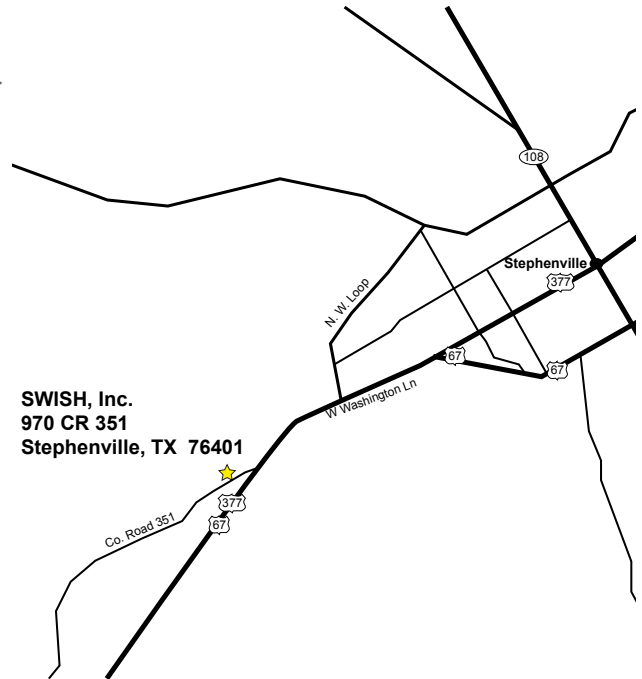



WISH, Inc.
 888 Ventura Street
 Aurora, CO 80011
 Phone: 303-364-0777
 Fax: 303-364-5055
 Email: wish_co@msn.com

Western Irrigation Supply House, Inc. (WISH), has been serving the needs of the agricultural irrigation community in the Central Plains since 1975.

Presently, WISH represents over 100 of the top manufacturers and suppliers in the industry, whose products we distribute throughout Colorado, Wyoming, and portions of Nebraska and Kansas.

Dealers are invited to visit when in the area. During your visit, we would like to give you a personalized tour of WISH's facility and your product selection. Also, we would like for you to meet everyone at WISH who works daily to earn your business. If you have time, we would like to visit with you about ways in which we can work together in helping you grow your business.

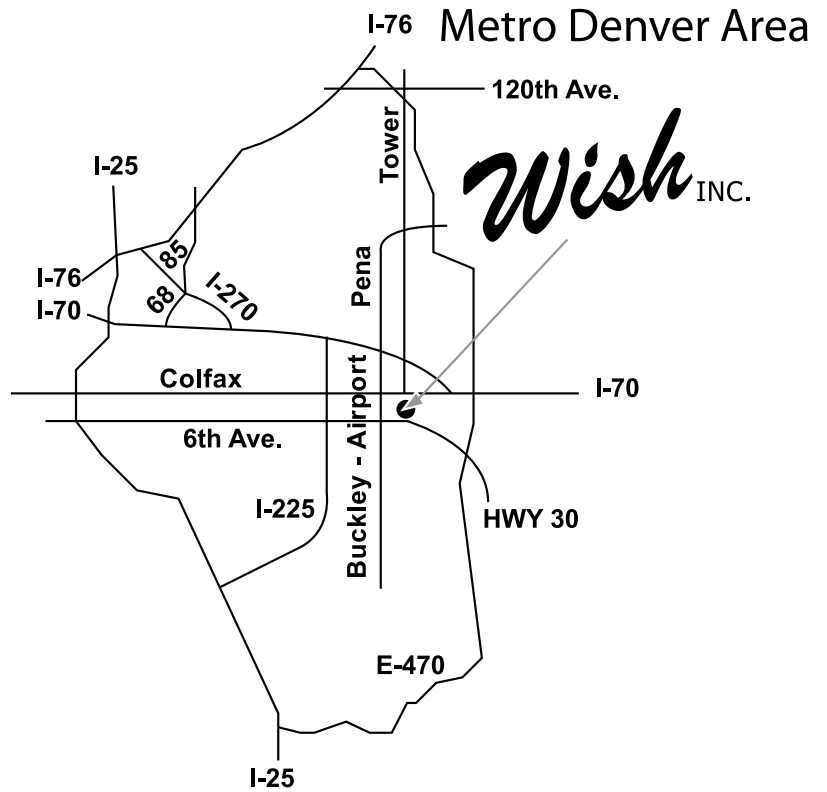

INTRO
 1. ELECTRICAL
 2. PUMP Acc.
 3. HOSE, PE PIPE & Acc.
 4. IPS, PIP PIPE & Acc.
 5. SURFACE
 6. SPRINKLERS
 7. TRAVELER & WHEEL MOVE
 8. PIVOT
 9. TURF
 10. LOW VOLUME
 11. FILTERS
 12. INJECTION
 13. HARDWARE
 INDEX

Wish

NEBRASKA, INC.

WISH Nebraska, Inc.

730 C Street

Ulysses, NE 68669

Phone: 402-549-2181

Fax: 402-549-2183

Email: wishne@clarks.net

WISH NEBRASKA, INC., (WISH NE) opened for business in Ulysses, Nebraska in January 1985.

WISH NEBRASKA is a premier irrigation wholesale supply center with a diverse product offering for all applications including pivot, solid set, pipeline, subsurface drip, low volume drip and turf. We represent over 100 of the top manufacturers and suppliers in the industry. From the pump to the end of the irrigation output, we can supply you with what you need. WISH NE distributes products throughout Nebraska, Kansas, South Dakota, North Dakota, Minnesota, Iowa, Missouri, Illinois, Wisconsin, Indiana, Michigan, Ohio and Canada.

Dealers are invited to visit when in the area. During your visit we would like to give you a tour of WISH NE's facility and your product selection. Also we would like you to meet everyone at WISH NE who works hard daily to earn your business. We hope our selection of products will earn your business and our service will keep your business. Working together, we will help you grow your business. Stop in and see us!

From I-80 at the Seward exit, go north of Seward about 12 miles on Hwy 15. Turn left (west) on Hwy 66 for 5 miles. Then turn left (south) at the "Welcome to Ulysses" sign, staying on the blacktop. Go 4 blocks then turn right heading west. Proceed straight west until you reach the west edge of town. On the right hand side, you will see our facility of 3 large metal buildings and an old school house.

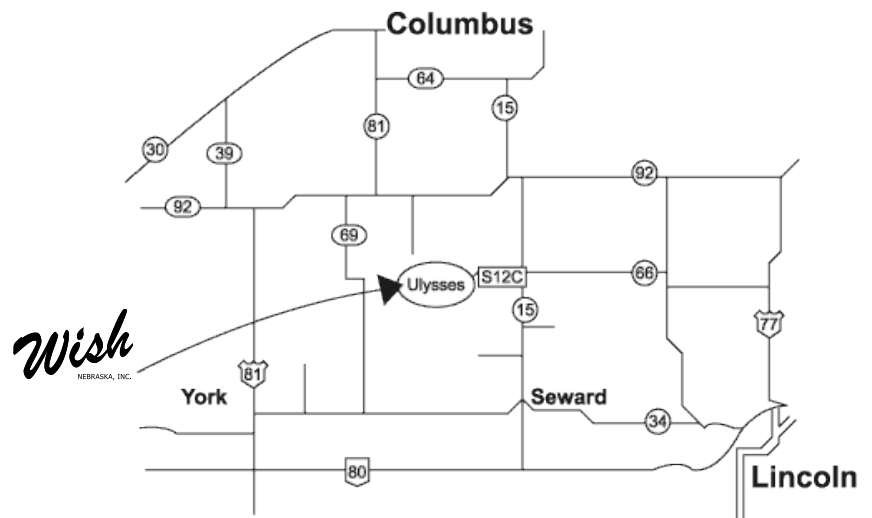

Wish

NORTHWEST, INC.

- Pocatello, ID - Kennewick, WA

WISH NORTHWEST

**303 Industrial Lane
Pocatello, ID 83201**

Phone: 208-232-0644 888-642-0644

Fax: 208-232-0694

Email: wninc@qwestoffice.net

Wish Northwest Inc. (WISH NW) was incorporated and opened for business in Pocatello Idaho in January of 1994. In 2011 with substantial growth and to better serve our dealer network WISH NW opened a store in the Tri-Cities (Washington).

For the past two decades WISH NW has worked diligently with over 100 of the top manufacturers and suppliers in the industry. Wish NW works daily supporting our dealer network throughout Idaho, Washington, Oregon, Nevada, Utah, Montana, Northern California, Western Wyoming, & the Canadian province above this territory. Wish NW understands the high need for efficiency and speed of delivery. Our goal is to supply our dealers with the most up to date and accurate knowledge, supply the highest quality of product on the market at the most competitive pricing, and do so with same day service.

Wish Northwest has an open invitation to our dealer network to stop by either warehouse and take a personal tour to let us show you how we strive to support your business. With over 65,000 square feet of warehouse space Wish NW truly is your Northwest ONE stop source for all of your irrigation needs.

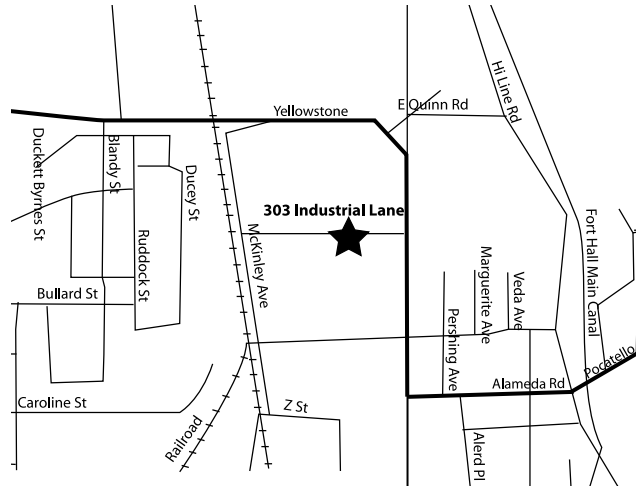

WISH NORTHWEST WASHINGTON

514 EAST 1ST AVE.

Kennewick, WA 99336

Phone: 509-582-7592 Fax: 509-582-7528

Email:wishnw1@clearwire.net



INTRO
1. ELECTRICAL
2. PUMP, ACC.
3. HOSE, PE PIPE & ACC.
4. IPS, PIP PIPE & ACC.
5. SURFACE
6. SPRINKLERS
7. TRAVELER & WHEEL MOVE
8. PIVOT
9. TURF
10. LOW VOLUME
11. FILTERS
12. INJECTION
13. HARDWARE
INDEX





3

- Section 1 -
Electrical Cable & Accessories

- Section 2 -
Pump Accessories

- Section 3 -
Hose, Fittings & Accessories

- Section 4 -
PVC PIP & IPS Pipe & Accessories

- Section 5 -
Surface Irrigation

- Section 6 -
Sprinkler Irrigation

- Section 7 -
Travelers & Wheel Move

- Section 8 -
Pivot Irrigation

- Section 9 -
Turf Irrigation

- Section 10 -
Low Volume Irrigation

- Section 11 -
Filters

- Section 12 -
Injection Equipment

- Section 13 -
Hardware

- Section 14 -
Technical Resources & Index



6



9



13

SECTION 1

ELECTRICAL - CABLE & ACCESSORIES

CONTENTS

1:3	ELECTRICAL - CABLE & ACCESSORIES NOTES
1:4-5	POWER DISTRIBUTION CABLE
1:5	MULTI CONDUCTOR CABLE
1:6-7	PIVOT SYSTEM CABLE
1:8	SUBMERSIBLE PUMP CABLE
1:8	GROUNDING MATERIAL
1:9	UNDERGROUND CIRCUIT CABLE
1:10	WIRE SPLICING SUPPLIES
1:10-12	WIRE CONNECTORS
1:12	CORD CONNECTORS
1:13	INSULATED BLOCKS
1:14	TAPE
1:14	CABLE TIES
1:14	WIRE STRIPPERS
1:15	WIRE TOOLS
1:15	CABLE CUTTERS
1:15	CRIMPING TOOLS
1:16	PVC SCH. 40 CONDUIT & FITTINGS
1:17	EMT CONDUIT, FITTINGS
1:17-18	MOUNTING ACCESSORIES
1:19	INSULATED CONNECTORS AND FLEX TUBING
1:19	NON-METALLIC FLEXIBLE CONDUIT & FITTINGS
1:19	METALLIC FLEXIBLE CONDUIT & AMERICAN FITTINGS
1:20-21	DIGITAL PHASE CONVERTER
1:20	PHASE PERFECT® DIGITAL PHASE CONVERTERS
1:21	AGP SERIES VARIABLE FREQUENCY DRIVES (VFD)
1:22-23	SAFETY SWITCH
1:22	EATON / CUTLER-HAMMER - DISCONNECT SWITCH
1:23	SIEMENS SAFETY SWITCHES - OUTDOOR TYPE 3R
1:24	METER BASES & BOX ENCLOSURES
1:24	METER BASES
1:24	POLYCARBONATE BOX ENCLOSURES
1:25	TERMINAL & JUNCTION BOXES
1:25	TERMINAL BOXES
1:25	JUNCTION BOXES
1:25	GE TERMINAL BLOCKS
1:25	POWER DISTRIBUTION BLOCKS
1:26	RELAYS
1:27	CONTACTORS
1:28-29	FUSE HOLDERS
1:30-31	FUSES
1:30	FLNR 250 VAC, FLQ 500 VAC & CCMR 600 VAC FUSES
1:31	FLSR 600 VAC ID FUSES
1:31	JTD 600 VAC ID BOLT-IN FUSES
1:31	GLASS BODY FUSES
1:32-33	GREENLEE® ELECTRICAL DIAGNOSTIC EQUIPMENT



QUADRUPLIX ALUMINUM

Quadruplex aluminum is a 600 volt secondary UD cable, consisting of three individual phase conductors and one neutral conductor. Each of these conductors are individually insulated with a cross-linked polyethylene jacket, then twisted together to produce the Quadruplex cable configuration. Quadruplex is used for secondary power distribution and underground service at 600 volts or less, either direct burial or in duct.

Part No.	AWG Size	Neutral	Code Name	Lbs. / 1000'	Put-Ups
230025	#4	#4	Tulsa	263	12,000' or CTL
230035	#2	#4	Dyke	353	12,000' or CTL
230037	#2	#2	Wittenburg	382	12,000' or CTL
230055	#1/0	#2	Notre Dame	556	6,000' or CTL
230056	#1/0	#1/0	Purdue	614	6,000' or CTL
230065	#2/0	#1/0	Syracuse	686	6,000' or CTL
230085	#4/0	#2/0	Wake Forest	1014	6,000' or CTL
230095	#250MCM	#3/0	Rust	1213	3,000' or CTL
230105	#350MCM	#4/0	Slippery Rock	1596	3,000' or CTL
230205	#500MCM	#350MCM	Wofford	2251	1,500' or CTL



**Please Call
for Pricing**

CABLE IN CONDUIT

This is quadruplex aluminum 600 volt secondary UD cable, encapsulated in a high density polyethylene conduit to provide protection to the cable from rodent damage, rock puncture, etc. Cable in Conduit can be ordered with kill wire, quadruplex aluminum cable, remote panel tray cable or any combination thereof. Ready to install, Cable in Conduit provides a cost effective, excellent option to manually stringing cable through a PVC conduit. Schedule 40 conduit, (Colorado UL listed) available in CO, WA, OR.

Part No.	AWG Size	Duct	Lbs. / 1000'	Put-Ups
240040	2 - #12	3/4"	160	6000' or CTL
240061	4 - #6 + 6 - #12	1-1/4"	624	6000' or CTL
240071	4 - #4	1-1/4"	487	6000' or CTL
240075	4 - #4 + 2 - #12	1-1/4"	579	6000' or CTL
240077	4 - #4 + 7 - #12	1-1/4"	631	6000' or CTL
240078	4 - #4 + 6 - #12	1-1/4"	608	6000' or CTL
240081	3 - #2 + 1 - #4	1-1/4"	574	6000' or CTL
240085	3 - #2 + 1 - #4 + 2 - #12	1-1/4"	666	6000' or CTL
240086	4 - #2 + 2 - #12	1-1/4"	693	6000' or CTL
240087	3 - #2 + 1 - #4 + 7 - #12	1-1/4"	712	6000' or CTL
240088	4 - #2	1-1/4"	603	6000' or CTL
240103	3 - #1/0 + 1 - #2 + 2 - #12	1-1/2"	889	4500' or CTL
240105	3 - #1/0 + 1 - #4 + 2 - #12	1-1/2"	867	4500' or CTL
240106	3 - #1/0 + 1 - #4	1-1/2"	821	4500' or CTL
240107	4 - #1/0	2"	1039	4500' or CTL
240205	3 - #2/0 + 1 - #2 + 2 - #12	2"	1169	3000' or CTL
240206	3 - #2/0 + 1 - #2	2"	1099	3000' or CTL
240206F	4 - #2/0	2"	1187	3000' or CTL
240305	3 - #4/0 + 1 - #2 + 2 - #12	2"	1428	3000' or CTL
240405	3 - #4/0 + 1 - #2	2"	1360	3000' or CTL
240405F	4 - #4/0	2"	1535	3000' or CTL
240450	3 - #250MCM + 1 - #1/0	2-1/2"	1885	1500'
240450F	4 - #250MCM	2-1/2"	2056	1500'
240505	3 - #350MCM + 1 - #4/0	2-1/2"	2272	1500'
240506	3 - #350MCM + 1 - #2/0	2-1/2"	2255	1500'
240506F	4 - #350MCM	2-1/2"	2508	1500'
240605	3 - #500MCM + 1 - #2/0	2-1/2"	2735	1500'
240605F	4 - #500MCM	3"	2973	1500'



**Please Call
for Pricing**

COPPER TRAY CABLE W/ REDUCED GROUND

The copper tray cable in this section consists of three individual phase conductors and one reduced ground. It is designed to supply power to motors or for connection to other power devices. Rated for 600 volts, 90° C dry and 75° C wet, it is specifically approved for direct burial, wet or dry locations, and outdoor in cable trays where a sunlight resistant rating is required. It is constructed of bare soft annealed stranded copper with high dielectric PVC insulation covering the individual conductors. The individual conductors are assembled round with PVC fillers added as needed. A tape binder is applied over the assembly, then it is covered with an overall PVC jacket.



Please Call for Pricing

Part No.	AWG Size	Ground	Lbs. / 1000'	Put-Ups
305122	#12/3	#12	128	5000' or CTL
305202	#10/3	#10	198	5000' or CTL
305302	#8	#10	282	5000' or CTL
305402	#6	#8	417	4000' or CTL
305502	#4	#8	604	3000' or CTL
305602	#2	#6	940	2000' or CTL
305615	#1	#6	1193	1000' or CTL
305702	#1/0	#6	1442	1000' or CTL
305802	#2/0	#6	1731	1000' or CTL
305902	#3/0	#4	2159	1000' or CTL
305942	#4/0	#4	2617	1000' or CTL

MULTI CONDUCTOR CABLE

UF/NMC-B (KILL WIRE)

This copper cable is normally used for underground feeder or branch circuit wiring for installation above or below ground, including direct burial, and in wet or corrosive locations. It is constructed of solid, annealed bare copper, having PVC insulation and a sunlight resistant PVC overall jacket. It may be purchased by the foot, or per 5,000 ft. spool. The 2 - #12 plain & w/ground is commonly used as "kill wire" in direct burial application.



Please Call for Pricing

Part No.	AWG Size	Description	Lbs. / 1000'	Put-Ups
115220801097	2 - #12	CDRS -THHN/THWN Stranded Conductor Black	86	5,000' or CTL
102220800075	2 - #12	UF/ NMC-B / Solid Conductor Grey	86	
170110	2 - #12 W/G	UF/ NMC-B / Solid Conductor Grey w/ Ground	100	
102310900075	3 - #10 W/G	UF/ NMC-B / Solid Conductor Grey w/ Ground	194	

SOOW CABLE

RoHS Compliant, UL Listed and CSA Certified for indoor or outdoor use. This copper cable has a wide variety of applications requiring flexibility and mechanical toughness, some of which include push button remote controls, industrial equipment, lighting, battery chargers, welding leads, power extensions, mining applications, and it's suitable and approved for submersion in water. Its flexible and tough jacket offers excellent abrasion, ozone, sunlight, chemical and oil resistance as well as being water and mold resistant. It is lightweight, long lasting, easy to carry and easy to handle. It is black in color, rated for 600 volts and operates between -40°C and 90°C temperature extremes. The color coded conductors provide easy identification.



Please Call for Pricing

Part No.	AWG Size	No. Conductors	Lbs. / 1000'	Put-Ups
55-88-99-05	#14	3	174	500'
55-81-02-05	#14	4	210	500'
55-80-94-05	#12	3	232	500'
55-80-95-05	#12	4	281	500'
55-80-97-05	#10	3	301	500'
55-80-96-05	#10	4	363	500'
55-80-88-05	#8	3	477	500'
55-80-93-05	#8	4	616	500'

1. ELECTRICAL
2. PUMP Acc.
3. HOSE, PE PIPE & Acc.
4. IPS, PIP Pipe & Acc.
5. SURFACE
6. SPRINKLERS
7. TRAVELER & WHEEL MOVE
8. PIVOT
9. TURF
10. LOW VOLUME
11. FILTERS
12. INJECTION
13. HARDWARE
INDEX

PROOF POSITIVE® SPAN CABLE

Copper Theft Epidemic: Theft of copper cable is on the rise due to global demand and increasing scrap value. Some estimates reflect 30,000 span cable thefts annually in the U.S., costing \$40 million to replace.

The Solution: Proof Positive® Span Cable: Proof Positive® Span Cable is a traceable, theft deterrent span cable that provides Ag dealers and growers with proof of ownership of their cable:

- Marker tape contains TraceID codes unique to every three inches.
- Upon sale, ownership data is entered in an online database (www.2IDCU.com) accessible to recyclers & law enforcement.
- Bright yellow outer jacket covering and marking provides a visual alert for recyclers and thieves that this is 'that traceable cable'.
- Recyclers can enter TraceID codes into a database to confirm ownership of suspected stolen cable.
- Law enforcement has physical proof for prosecution.

Part No.	AWG Size	Description	Lbs. / 1000'	Put-Ups
200050PPS	10C (10/4 - 14/6)	Span Cable	340 Lbs./Mft	6000'
231080PPS	11C (10/4 - 14/7)	Span Cable	400 Lbs./Mft	6000'

Agriculture's best defense against copper theft.



SPAN CABLE

This 600 volt cable has been designed specifically to operate electric motor driven irrigation systems - namely center pivot and linear move systems. Its construction consists of multiple conductors of stranded soft annealed uncoated copper with PVC and nylon insulation. Each conductor is color coded for easy and quick recognition. The insulated conductors are cabled together in a suitable lay with a mylar tape wrapped helically over the assembly. A corrugated or flat specially coated aluminum shield is bonded to a polyethylene outer jacket, with the inner side uncoated in order to make contact with the drain wire. The shielded drain is 16 AWG 7 strand T/C drain wire inserted under the aluminum shield for termination and grounding. The outer jacket is a minimum .050 inch thick sunlight resistant polyethylene cover which averages .750 inch outside diameter.

Part No.	AWG Size	Description	Lbs. / 1000'	Put-Ups
200060	10/4 - 14/7	Span Cable	525 Lbs.	5000' or CTL



SHIELDED MOTOR DROP

This 14 AWG 4 conductor color coded cable has been designed to operate electric motor driven irrigation systems. It is commonly used as "Motor Drop", supplying power from the tower box to the center drive motor. It consists of 4 conductors of stranded soft annealed uncoated copper, insulated in a PVC and nylon cover. These conductors are cabled utilizing a PVC inner jacket, and an aluminum shield bonded to a polyethylene outer jacket which provides excellent mechanical strength, moisture resistance and sunlight resistance.

Part No.	AWG Size	Description	Lbs. / 1000'	Put-Ups
200010	14/4	Motor Drop	190 Lbs.	500', 5000' or CTL



**Please Call
for Pricing on all
Pivot System Cable**

ARMORED PERIMETER GUIDANCE CABLE

This is a direct burial cable designed specifically to guide center pivot corner systems. Its construction consists of a 14 AWG solid copper conductor insulated with sunlight resistant polyethylene, armored with 5mil stainless steel tape and having a 30mil black PVC sunlight resistant jacket overall.

Part No.	AWG Size	Description	Lbs. / 1000'	Put-Ups
220023	14/1	Armored Perimeter Cable	90	7,000' - 11,000' - 13,000' or CTL



SHIELDED BURIED SIGNAL CABLE

This is a multi pair direct burial shielded cable designed to carry a signal to irrigation control equipment. It's constructed of stranded soft annealed tin coated copper conductor with high density polyethylene insulation. The insulated conductors are twisted into a pair and then cabled together with an aluminum mylar shield helically applied with a 20 AWG tinned copper drain wire laid under the shield, with an overall polyethylene jacket.

Part No.	AWG Size	Description	Lbs. / 1000'	Put-Ups
19G2PR0001	19/4 (2 pair)	Shielded Buried Signal Cable	86	10,000' or CTL



REMOTE PANEL TRAY CABLE

This is a multi conductor tray cable specifically designed as control or instrumentation cable. Its uses include control, power, lighting, signals and relay or traffic control. It is rated 600 volts, 90° C dry and 75° C wet, and is approved for outdoors in cable trays where a sunlight resistant rating is required, or for direct burial. It is constructed of bare bunch stranded soft annealed copper with high dielectric PVC insulation covering the individual conductors. Individual conductors are assembled round with PVC fillers added as needed, then covered with an overall PVC jacket.

Part No.	AWG Size	Description	Lbs. / 1000'	Put-Ups
P233005	14/7	Tray/Remote Panel Wire	145	5,000' or CTL
P233105	12/7	Tray/Remote Panel Wire	207	6,000' or CTL
P680483	12/9	Tray/Remote Panel Wire	303	5,000' or CTL



**Please Call
for Pricing on all
Pivot System Cable**

INTRO | 1. ELECTRICAL | 2. PUMP ACC. | 3. HOSE, PE PIPE & ACC. | 4. IPS, PIP PIPE & ACC. | 5. SURFACE | 6. SPRINKLERS | 7. TRAVELER & WHEEL MOVE | 8. PIVOT | 9. TURF | 10. LOW VOLUME | 11. FILTERS | 12. INJECTION | 13. HARDWARE | INDEX

SUBMERSIBLE PUMP CABLE

PVC FLAT JACKETED HEAVY-DUTY SUBMERSIBLE PUMP CABLE WITH GROUND

This tough THW insulated and PVC flat jacketed heavy-duty pump cable features stranded bare copper conductors for maximum flexibility and ease of handling and installation. Designed for the best in mechanical protection, it is constructed of 4 stranded bare copper conductors with color coded double insulated PVC, laid parallel and jacketed with a heavy duty black sunlight resistant PVC jacket. Three conductor cables are color coded black, red and yellow. Grounding conductors are green. This 600 volt, UL listed 75°C cable is primarily used to provide power to deep well submersible pumps where maximum physical protection is needed or required.



Part No.	Conductor Size, AWG		Dimension (Inches)			Standard Packaging	Ampacity NEC§	Weight (Lbs./Mft.)
	Power	Ground Conductors Size AWG	Insulation Thickness MIL	Jacket Thickness MIL	O.D			
PFB14/3GG	14/3 (7 str)	14 (7 str)	.045	.045	.261 x .763	500', 1000' & CTL	15	145
PFB12/3GG	12/3 (19 str)	12 (19 str)	.045	.045	.280 x .840	500', 1000' & CTL	20	189
PFB10/3GG	10/3 (19 str)	10 (19 str)	.045	.045	.305 x .940	500', 1000' & CTL	30	255
PFB8/3GG	8/3 (19 str)	10 (19 str)	.060	.045	.364 x 1.120	500', 1000' & CTL	50	374
PFB6/3GG	6/3 (19 str)	8 (19 str)	.060	.045	.414 x 1.336	500', 1000' & CTL	65	522
PFB4/3GG	4/3 (19 str)	8 (19 str)	.060	.045	.465 x 1.489	500', 1000' & CTL	85	714
PFB2/3GG	2/3 (19 str)	6 (7 str)	.060	.045	.535 x 1.749	500', 1000' & CTL	115	1,036
PFB1/03GG	1/03 (19 str)	6 (7 str)	.080	.060	.660 x 1.990	CTL	150	1,613
PFB2/03GG	2/03 (19 str)	6 (7 str)	.080	.060	.700 x 2.120	CTL	175	1,932
PFB3/03GG	3/03 (19 str)	6 (7 str)	.080	.060	.734 x 2.314	CTL	200	2,135
PFB4/03GG	4/03 (19 str)	6 (7 str)	.080	.060	.800 x 2.490	CTL	230	2,871
PFB250/3GG	250/3 (37 str)	4 (7 str)	.095	.080	.925 x 2.807	CTL	235	3,518
PFB350/3GG	350/3 (37 str)	4 (7 str)	.095	.080	1.031 x 3.153	CTL	310	4,689
PFB500/3GG	500/3 (37 str)	3 (7 str)	.095	.080	1.163 x 3.590	CTL	380	6,410



PVC ROUND JACKETED 75°C/ 600V

This UL listed Type THW round submersible pump cable is a multipurpose cable with individually insulated color coded conductors, green insulated ground (optional) and an overall jacket. Construction provides copper stranding insulated with a polyvinyl chloride (PVC) compound. A tough PVC jacket is easily stripped to facilitate installation yet provide optimum flexibility, mechanical protection and crush resistance.



- UL listed as Type THW Submersible Pump cable
- Acid, alkali, oil and grease resistant jacket
- Abrasion and crush resistant
- Oil and grease resistant conductors
- Weather, ozone and sunlight resistant jacket
- Sequential Footage Marks

Part No.	Conductor Size, AWG		Dimensions (inches)			Standard Packaging	Ampacity NEC	Weight (Lbs./Mft.)	Price
	Power	Ground	Insulation	Jacket	O.D.				
PMPTJ14/3GG	14 (7str)	14 (7str)	.045	.045	.483	500' & 1,000'	15	130	
PMPTJ12/3GG	12 (19str)	12 (19str)	.045	.045	.528	500' & 1,000'	20	171	
PMPTJ10/3GG	10 (19str)	10 (19str)	.045	.045	.623	500' & 1,000'	30	238	
PMPTJ8/3GG	8 (19str)	10 (19str)	.060	.045	.732	500' & 1,000'	50	333	
PMPTJ6/3GG	6 (19str)	8 (19str)	.060	.045	.824	500' & 1,000'	65	475	
PMPTJ4/3GG	4 (19str)	8 (19str)	.060	.060	.924	500' & 1,000'	85	640	
PMPTJ2/3GG	2 (19str)	6 (19str)	.060	.060	1.098	500' & 1,000'	115	950	

GROUNDING MATERIAL

BARE COPPER GROUND WIRE & GROUNDING ROD

#6 Solid Bare Copper Ground Wire with Copper Plated High Carbon Steel Grounding Rod

Part No.	Description	Weight - Lbs.	Std. Pkg.	Price
SBC-6-315	#6 Solid Bare Copper	25.2	315'	
GR58X8	5/8" x 8' Grounding Rod	7.1	1	
GRC58	5/8" Clamp	.15	1	



SINGLE CONDUCTOR UNDERGROUND FEEDER

This wire is rated for 600V and is constructed of soft drawn bare solid copper conductor with a PVC insulated jacket. Common uses include agricultural, parks and golf course application where long runs are often required. Standard colors include white, red, blue, black and green. *Note: 18AWG and 16 AWG are not permitted to be UL listed as type UF.

Size	Color	Part No. 2500'	Price	Part No. 500'	Price
18AWG	Red	I181UF-02-2.5M	Please Call for Pricing	I181UF-02-5C	Please Call for Pricing
18AWG	White	I181UF-09-2.5M		I181UF-09-5C	
16AWG	Red	I161UF-02-2.5M		I161UF-02-5C	
16AWG	White	I161UF-09-2.5M		I161UF-09-5C	
14AWG	Black	I141UF-00-2.5M		-	
14AWG	Brown	I141UF-01-2.5M		-	
14AWG	Red	I141UF-02-2.5M		I141UF-02-5C	
14AWG	Orange	I141UF-03-2.5M		-	
14AWG	Yellow	I141UF-04-2.5M		-	
14AWG	Green	I141UF-05-2.5M		-	
14AWG	Blue	I141UF-06-2.5M		-	
14AWG	Purple	I141UF-07-2.5M		-	
14AWG	White	I141UF-09-2.5M		I141UF-09-5C	
12AWG	Red	I121UF-02-2.5M		I121UF-02-5C	
12AWG	White	I121UF-09-2.5M		I121UF-09-5C	
10AWG	White	I101UF-09-2.5M		I101UF-09-5C	



18 AWG MULTI CONDUCTOR CABLE

Normally used in the wiring of turf irrigation systems where the cable must be suitable for direct burial. Each conductor is individually colored with a polyethylene cover having a nominal insulation thickness of .016". The outer jacket is a soft and easy-to-cut SRPVC with .025" thickness.

No. of Conductors	Part No. 2500'	Price	Part No. 1000'	Price	Part No. 250'	Price
2	I182IRRA-2.5M	Please Call for Pricing	-	Please Call for Pricing	*I182IRRA-5C	Please Call for Pricing
3	I183IRRA-2.5M		I183IRRA-1M		I183IRRA-2.5C	
4	I184IRRA-2.5M		I184IRRA-1M		I184IRRA-2.5C	
5	I185IRRA-2.5M		I185IRRA-1M		I185IRRA-2.5C	
6	I186IRRA-2.5M		I186IRRA-1M		I186IRRA-2.5C	
7	I187IRRA-2.5M		I187IRRA-1M		I187IRRA-2.5C	
8	I188IRRA-2.5M		I188IRRA-1M		I188IRRA-2.5C	
9	I189IRRA-2.5M		I189IRRA-1M		I189IRRA-2.5C	
10	I1810IRRA-2.5M		I1810IRRA-1M		I1810IRRA-2.5C	
12	I1812IRRA-2.5M		I1812IRRA-1M		I1812IRRA-2.5C	
13	I1813IRRA-2.5M		I1813IRRA-1M		I1813IRRA-2.5C	
16	I1816IRRA-2.5M		I1816IRRA-1M		I1816IRAA-5C	
25	I1825IRRA-2.5M		I1825IRRA-1M		I1825IRAA-5C	

*NOTE: 18-2 Available in 2500' and 500' rolls only

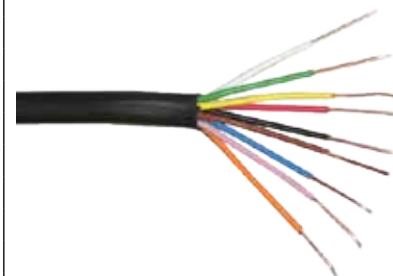

LOW VOLTAGE LANDSCAPE LIGHTING CABLE

UL rated for direct burial, these popular landscape lighting cables are used for wiring portable and stationary outdoor accent lighting fixtures. This wire is rated for 300V and is constructed of bare stranded copper conductor with PVC insulation, laid flat parallel in an overall black PVC jacket. The temperature rating is from -20°C to 60°C.

Part No. 500'	Size AWG	Conductors	Insulation (Type, Thickness)	Nominal O.D	Price
142ULC-5C	14	2	PVC, .45"	.350" x .170"	Please Call for Pricing
122ULC-5C	12	2	PVC, .45"	.390" x .195"	
102ULC-5C	10	2	PVC, .45"	.470" x .240"	
802ULC-5C	8	2	PVC, .78"	.630" x .316"	



INTRO 1. ELECTRICAL 2. PUMP Acc. 3. HOSE, PE PIPE & Acc. 4. IPS, PIP PIPE & Acc. 5. SURFACE 6. SPRINKLERS 7. TRAVELER & WHEEL MOVE 8. PIVOT 9. TURF 10. LOW VOLUME 11. FILTERS 12. INJECTION 13. HARDWARE INDEX

WIRE SPlicing SUPPLIES

48" HEAT SHRINK TUBE

Part No.	Cable Range	Expanded	Recovered	Price
ITCSN-0400-48	12-6 AWG	.40"	.15"	
ITCSN-0800-48	8-1/0 AWG	.80"	.20"	
ITCSN-1100-48	2-4/0 AWG	1.10"	.37"	
ITCSN-1500-48	3/0 AWG - 400 KCMIL	1.50"	.50"	
ITCSN-2000-48	250-750 KCMIL	2.00"	.65"	
ITCSN-3000-48	600-1250 KCMIL	3.00"	1.00"	
ITCSN-4500-48	1500-2500 KCMIL	4.50"	1.50"	
ITCSN-6000-48	2.1" - 4.8"	6.00"	1.80"	



UNINSULATED BUTT SPLICE

Use for Copper or Aluminum Splices. Each type of butt splice is designed to meet specific application requirements and provide a high quality electrical splice connection that is easily installed. After proper installation of the butt splice, select the proper insulation and sealing materials (tape, heatshrink, etc.) for each application.

Part No.	Cable Range	Box Qty	Price
12106	14 - 16 AWG	100	
12108	12 - 10 AWG	50	
YSU6W6W	8 AWG	100	
YSU4W8W	#6 - #8	100	
YSU4W4W	6 AWG	100	
YSU2W4W	#4 - #6	100	
YSU2W2W	4 AWG	100	
YSU2R2W	#2 - #4	100	
YSU2R2R	2 AWG	100	
YSU25R2R	1/0 - #2	100	
YSU25R25R	1/0 AWG	100	
YSD26R2R	2/0 - #2	25	
YSD26R26R	2/0 AWG	25	
YSD28R26R	4/0 - 2/0	25	
YSD28R28R	4/0 AWG	25	

Part No.	Cable Range	Box Qty	Price
93226 (Al)	250 MCM	9	
94428 (Cu)	250 MCM	9	
93230 (Al)	350 MCM	9	
94432 (Cu)	350 MCM	9	
93234 (AL)	500 MCM	9	
94436 (Cu)	500 MCM	9	



SPLICE KITS FOR ALUMINUM & COPPER CABLE

Four wire splice kits for a waterproof direct bury aluminum to aluminum or copper to copper connection. Each wire kit contains 4 Butt Splices and 4 Black Heat Shrink Tubes.

Aluminum	Copper	Cable Range	Description	Price
HS4	HS4	14,12,10 AWG	3 Conductor with Ground	
LHS4	LHS4	8, 6 AWG	3 Conductor with Ground	
SK-Q-4	SK-Q-4	4 AWG	3 Conductor with Ground	
SK-Q-2	SK-Q-2	2 AWG	3 Conductor with Ground	
SK-Q-1/0	SK-Q-1/0	1/0 AWG	3 Conductor with Ground	
SK-Q-2/0	SK-Q-2/0	2/0 AWG	3 Conductor with Ground	
SK-Q-4/0	SK-Q-4/0	4/0 AWG	3 Conductor with Ground	
MSK-Q-250	SK-Q-250	250 MCM	3 Conductor with Ground	
MSK-Q-350	SK-Q-350	350 MCM	3 Conductor with Ground	
MSK-Q-500	SK-Q-500	500 MCM	3 Conductor with Ground	



WIRE CONNECTORS

SPEARS® DRI-SPLICE WIRE CONNECTORS

The SPEARS® Dri-Splice Seal designed into each wire hole enables you to stock one connector for all applications. The Dri-Splice Seal features an interference webbing which expands to accommodate #18, #14, #12, or #10 gauge wire sizes. In the event only two holes are used, the Dri-Splice Seal prevents sealant from leaking out through the third hole.

Part No.	Description	Qty / Bag	Price
DS-100	Dri-Splice Wire Connector w/ Crimp Sleeve (Sealant Sold Separately)	25	
DS-300	Tube Dri-Splice Sealant for DS100 Fills 24 Connectors	1	
DS-400	Pre Filled Dri-Splice Wire Connector with Crimp Sleeve	25	



3M™ NYLON-INSULATED 312 AND 512 ELECTRICAL SPRING CONNECTORS

The quick-spin, wing-torque design of 312 and 512 electrical spring connectors is easy on your fingers. Use the 312 (yellow) connector for wire combinations from 3 #20 to 3 #12 copper AWG and the 512 (red) connector for 2 #18 to 5 #12 300 volt copper AWG.

Part No.	Item Number	Color	Qty.	Price / Bag
312-Box	3 - #20 to 3 - #12	Yellow	100	
312-Bulk	3 - #20 to 3 - #12	Yellow	500	
512-Box	2 - #18 to 5 - #12	Red	100	
512-Bulk	2 - #18 to 5 - #12	Red	500	



KING INNOVATION SEALED CONNECTORS

Waterproof, prefilled silicone connectors for copper to copper connection. Dielectric sealant locks out moisture and corrosion. Sealant never hardens and works in extreme temperatures.

DRYCONN™ IRRIGATION CONNECTORS						
Approved for direct burial for 50 volts or less, 600v outdoor rating & 1000v in fixtures & signs. Temperature rating 221° F						
Part No.	Color	Bag Qty.	Connector Size	Wire Size		Price / Bag
61135	Black/White	25	7/16" x 27/32"	Min.	3 - #22	
				Max.	1 - #14 w/ 1 - #18	
61235	Black/Gray	20	21/32" x 1-5/16"	Min.	6 - #22	
				Max.	1 - #10 w/ 2 - #12	
61335	Black/Blue	10	13/16" x 1-9/16"	Min.	2 - #10	
				Max.	1 - #6 w/ 2 - #8	
10222	Blue/Blue	20	17/32" x 15/16"	Min.	2 - #16	
				Max.	2 - 5 #18	
PROLINE CONNECTORS						
Approved for direct burial for 600 volts, 1000 volts in fixtures. Temperature rating 167° F						
10444	Yellow	10	11/16" x 1-9/16"	Min.	4 - #18	
				Max.	1 - #10 w/ 1 - #14	
10555	Red	10	13/16" x 1-3/4"	Min.	2 - #14	
				Max.	2 - #10 w/ 1 - #14	
TAN LOW VOLTAGE WIRE CONNECTOR						
Approved for direct burial for maximum use of 30 volts / 10 amps maximum. Temperature rating 167° F						
20111	Tan	15	13/16" x 1-9/16"	Min.	3 - #22	
				Max.	2 - #10 w/ 1 - #10 & #12	
Note: Use 61135 in place of 10222 & 61235 in place of 20111.						



NORTHSTAR SURESPlice WIRE CONNECTORS

There are 2 sizes of Suresplice Wire Connectors with wire nuts to meet your needs. Connect two or more pre-stripped copper wire ends in a pigtail wire nut. Then insert the wire nut into the pre-filled tube to seal the connection for direct burial. Bright orange for high visibility. A non-melting synthetic, dielectric sealant that keeps the voltage in and corrosive elements out. Heat-rated up to 400° F or 204.4° C and well below zero temperatures. Splice kit provided with your choice of blue, orange, yellow, or red wire nuts. Use blue, orange or yellow wire nuts with Suresplice SK14-12G connectors, use red wire nuts with Suresplice SK-8-12G connectors.

SURESPlice SK14-12G & SK8-12G

Part No.	Description	Price
SK1412ORG-BWN	Suresplice 14-12 AWG Blue Wire Nut	
SK1412ORG-BWN50	Suresplice 14-12 AWG Blue Nut Qty 50	
SK1412ORG-OWN	Suresplice 14-12 AWG Orange Wire Nut	
SK1412ORG-OWN50	Suresplice 14-12 AWG Orange Nut Qty 50	
SK1412ORG-YWN	Suresplice 14-12 AWG Yellow Wire Nut	
SK1412ORG-YWN50	Suresplice 14-12 AWG Yellow Nut Qty 50	
SK812ORG-RWN	Suresplice 8-12 AWG Red Wire Nut	
SK812ORG-RWN50	Suresplice 8-12 AWG Red Nut Qty 50	



Maximum Wire Combinations	
Blue Wire Nut	6 - #18 Multi conductor Wire
Orange Wire Nut	2 - #14 or 4 - #16
Yellow Wire Nut	2 - #10 or 3 - #12 or 4 - #14
Red Wire Nut	6 - #14 or 4 - #12 or 4 - #10 or 4 - #8

1. ELECTRICAL 2. PUMP Acc. 3. HOSE, PE PIPE & Acc. 4. IPS, PIP Pipe & Acc. 5. SURFACE 6. SPRINKLERS 7. TRAVELER & WHEEL MOVE 8. PIVOT 9. TURF 10. LOW VOLUME 11. FILTERS 12. INJECTION 13. HARDWARE INDEX

WIRE CONNECTORS

3M DIRECT BURY SPLICE CONNECTORS

For waterproof direct bury copper to copper connection. Each connector includes gel filled insulator tube and Scotchlok electrical spring connector. Maximum voltage is 30 volts.

Part No.	Common AWG Wire Combinations		Reference	Price
270325	2-3 #16	2 #18 to 1-2 #4	3M DBY	
	2-3 #14	1 #18 to 1-3 #12		
	2 #12	1 #16 to 1-2 #12		
	1 #14 to 1 #12			
270327	2-3 #10	1 #10 to 1 or 2 #14	3M DBR	
	2-4 #12	1 #12 to 1 or 2 #14		
	3-4 #14	1 #12 to 2 or 3 #16		
	4-6 #16	1 #14 to 2 or 3 #16		
	1 #10 to 1 #12			



WATERTITE® PLUGS & CONNECTORS

20 AMP WATERTITE® PLUGS AND CONNECTORS

Part No.	Description	Voltage	Cord Grip Body Size	Configuration	Price
L1420PW	Plug	125 / 250	F3 3/4"	NEMA L14-20	
L1420CW	Connector	125 / 250	F3 3/4"	NEMA L14-20	
L1620PW	Plug	480 - 3PH	F3 3/4"	NEMA L16-20	
L1620CW	Connector	480 - 3PH	F3 3/4"	NEMA L16-20	



30 AMP WATERTITE® PLUGS AND CONNECTORS

Part No.	Description	Voltage	Cord Grip Body Size	Configuration	Price
L1430PW	Plug	125 / 250	F4 1"	NEMA L14-30	
L1430CW	Connector	125 / 250	F4 1"	NEMA L14-30	
L1630PW	Plug	480 - 3PH	F4 1"	NEMA L16-30	
L1630CW	Connector	480 - 3PH	F4 1"	NEMA L16-30	



CORD CONNECTORS

STRAIN RELIEF CORD CONNECTORS

PLASTIC CORD CONNECTORS

Part No.	Description	Price
LPCG507	1/2" MIPT Plastic Cord Connector, .375" - .750"	
LPCG757	3/4" MIPT Plastic Cord Connector, .375" - .750"	
NMCG100875	1" MIPT Plastic Cord Connector, .750" - .875"	



METAL CORD CONNECTORS

Part No.	Description	Price
CG1850S	1/2" MIPT Metal Cord Connector, .250" - .375"	
CG3775S	3/4" MIPT Metal Cord Connector, .375" - .500"	
CG50100S	1" MIPT Metal Cord Connector, .500" - .625"	



INSULATED MULTI TAP CONNECTIONS

INSULATED IN-LINE SPLICE

Part No.	Wire Range	Description	Price
97020	2/0 - 14	Black Insulated In-Line Splice	
97021	250MCM - 6	Black Insulated In-Line Splice	

SINGLE ENTRY SPLICE - BOTH WIRES ENTER SAME SIDE

Part No.	Wire Range	Description	Price
97102	4 - 14	Black Insulated Connector	
97106	2/0 - 14	Black Insulated Connector	

DUAL ENTRY SPLICE - OPTIONAL WIRE ENTRY FROM EITHER SIDE

Part No.	Wire Range	Description	Price
97116	2/0 - 14	Black Insulated Connector	
97118	250MCM - 6	Black Insulated Connector	

SINGLE ENTRY - MULTI-CABLE CONNECTOR

Part No.	Wire Range	Description	Price
97533	2/0 - 14	Black Insulated Multi-Cable - 3 Port	
97534	2/0 - 14	Black Insulated Multi-Cable - 4 Port	

DUAL ENTRY - MULTI-CABLE CONNECTOR

Part No.	Wire Range	Description	Price
97633	2/0 - 14	Black Insulated Multi-Cable - 3 Port	
97634	2/0 - 14	Black Insulated Multi-Cable - 4 Port	

2 CONDUCTOR - WIRE ENTRY FROM EITHER SIDE

Part No.	Wire Range	Description	Price
97312	4 - 14	Clear Insulated Multi Tap Connector Block	
97352	2/0 - 14	Clear Insulated Multi Tap Connector Block	
97392	250MCM - 6	Clear Insulated Multi Tap Connector Block	
97412	350MCM - 10	Clear Insulated Multi Tap Connector Block	
97432	500MCM - 6	Clear Insulated Multi Tap Connector Block	

3 CONDUCTOR - WIRE ENTRY FROM EITHER SIDE

Part No.	Wire Range	Description	Price
97314	4 - 14	Clear Insulated Multi Tap Conductor Block	
97354	2/0 - 14	Clear Insulated Multi Tap Conductor Block	
97394	250MCM - 6	Clear Insulated Multi Tap Conductor Block	
97414	350MCM - 10	Clear Insulated Multi Tap Conductor Block	
97434	500MCM - 6	Clear Insulated Multi Tap Conductor Block	

4 CONDUCTOR - WIRE ENTRY FROM EITHER SIDE

Part No.	Wire Range	Description	Price
97316	4 - 14	Clear Insulated Multi Tap Conductor Block	
97356	2/0 - 14	Clear Insulated Multi Tap Conductor Block	
97396	250MCM - 6	Clear Insulated Multi Tap Conductor Block	
97416	350MCM - 10	Clear Insulated Multi Tap Conductor Block	
97436	500MCM - 6	Clear Insulated Multi Tap Conductor Block	

Note: Other sizes & number of ports quoted upon request.

LUGS FOR COPPER & ALUMINUM CONDUCTORS

LUGS FOR COPPER & ALUMINUM CONDUCTORS

Part No.	Wire Range	Description	Price
90712	6STR-14Sol.	Aluminum Mechanical Lug	
90714	2STR-14Sol.	Aluminum Mechanical Lug	
90716	1/0STR-14Sol.	Aluminum Mechanical Lug	
90718	2/0STR-14Sol.	Aluminum Mechanical Lug	
90732	350MCM-6Sol.	Aluminum Mechanical Lug	
90734	600MCM-2Sol.	Aluminum Mechanical Lug	



TAPE

VINYL INSULATION TAPE

Part No.	Description	Price
3M #1700	3M™ Temflex™ 1700 Tape / 3/4" x 60' / for Indoor Use	
3M Super 33	3M™ Scotch® Super 33+ Tape / 3/4" x 66' / 0°F - 220°F	
3M Super 88	3M™ Scotch® Super 88 Tape / 3/4" x 66' / 0°F - 220°F	



SPLICING & TERMINATING TAPE

Part No.	Description	Price
3M #23X.75	3M™ Scotch® #23 Rubber Tape / 3/4" x 30'	
3M #23X1	3M™ Scotch® #23 Rubber Tape / 1" x 30'	
3M Scotchfil	3M™ Scotchfil™ Putty in Tape Form / 1-1/2" x 60"	



SEALING TAPE & COATING

Part No.	Description	Price
3M 2228	3M™ Scotch® 2228 Rubber Mastic Tape / 2" x 10'	
3M 2210	3M™ Scotch® 2210 Vinyl Mastic Tape / 4" x 10'	
3M Scotchkote	3M™ Scotchkote™ Electrical Coating / 15oz.	



CABLE & PIPE WRAP TAPE

Part No.	Description	Price
9051	Pasco 1" x 100' PVC 10mil Pipe Wrap Tape	
9052	Pasco 2" x 100' PVC 10mil Pipe Wrap Tape	
9054	Pasco 4" x 100' PVC 10mil Pipe Wrap Tape	



GENERAL PURPOSE DUCT & BUNDLING TAPE

Part No.	Description	Price
3M 1260	1.88" x 60yards 9.8mil Silver Duct Tape	



CABLE TIES

CABLE TIES

Part No.	Length	Description	Price/Bag
14002	4.1"	Black UVR Cable Tie 100 / Bag	
14003	7.5"	Black UVR Cable Tie 100 / Bag	
14063	11.2"	Black UVR Cable Tie 100 / Bag	
14065	14.5"	Black UVR Cable Tie 100 / Bag	



WIRE CUTTERS, STRIPPERS & CRIMPERS

WIRE CUTTERS, STRIPPERS AND CRIMPERS

Part No.	Description	Price
54052	LINEMAN'S PLIERS WITH CUTTER AND CRIMPER High-leverage tool with crimping die and side cutters. Crimping die at the hinge for crimp sleeve connectors	
54054	END CUTTING CRIMPING PLIERS Crimps 10 - 22 AWG non-insulated solderless terminals. Specially hardened wire cutter in nose. Forged Steel.	
54426	WIRE STRIPPER AND CUTTER 10 - 20 AWG precision ground stripping holes easily remove insulation. Copper wire cutter has precision shear-type blade.	
54430	5 IN 1 STRIPPER / CRIMPER / CUTTER 10 - 20 AWG precision ground stripping holes easily remove insulation. 10 - 22 AWG Insulated and non-insulated terminal crimper. No. 310, 311, 410, 411 and coax crimper. Bolt cutters 5-40, 10-24, 4-40, 6-32, 8-32 and 10-32. Stainless steel body and ergonomic, cushioned handles.	



WIRE CUTTERS

STEEL HANDLE WIRE CUTTER

Part No.	Length	Weight	Price
50050	30"	6.2 Lbs.	

- Maximum wire size: 750MCM Aluminum & 1000MCM Copper
- Shear type blades are made of forged, heat treated steel and precision ground for clean cuts
- Steel shear blade wire cutter with heavy-duty design for long, dependable service
- Steel handles with large rubber grips for greater strength, comfort and leverage



HAND WIRE CUTTER

Part No.	Length	Price
50060	9.8"	

- Maximum wire size: 2/0 Copper/Aluminum
- Heat treated, precision ground shear action for clean cuts
- Heavy-duty forged steel cutter
- High leverage handles are plastic coated for extra comfort and grip
- Blister packed



RATCHETING WIRE CUTTERS

Part No.	Length	Max. Cable Size	Price
50070	9.75"	400 MCM CU/AL	
50080	9.75"	750 MCM CU/AL	

- For cutting Copper & Aluminum cable
- Not for use on ASCR cable or steel wire
- Compact and portable
- Spring action mechanism
- Simple one-hand operation
- Less handle forces required
- Heat treated, precision ground shear action blades for clean cuts
- Blister packed



CRIMPING TOOLS

CRIMP TOOL WITH HEXAGON DIE (#6 - 1/0)

Part No.	Length	Price
50006	15"	

- Self-contained rotating dies in crimp head
- For #6 - 1/0 Copper compression lugs
- Crimp head: carbon-chromium-molybdenum alloy steel
- Steel handles with poly grips



CRIMP TOOL WITH HEXAGONAL DIE (#6-250MCM)

Part No.	Length	Price
50007	24"	

- Self-contained rotating dies in crimp head
- For #6 - 250MCM Copper compression lugs
- Crimp head: carbon-chromium-molybdenum alloy steel
- Steel handles with poly grips



MECHANICAL LUG CRIMPERS

Part No.	Length	Wire Range	Housing	Weight	Price
50008	25"	8-500MCM AL/CU	Forged	9.0 Lbs.	
50010	22"	8-4/0 AWG AL 8-250 MCM CU	Cast	6.2 Lbs.	

- Indenter crimpers for Aluminum and Copper lugs
- Buy one tool - no dies to order, no dies to loose
- Costs less than expensive hydraulic tools
- Quality construction - high strength steel body
- Adjustable indenter to cover a wide array of wire ranges and types of copper and aluminum lugs and splices
- Indenter body and indenter made of high strength steel for durability
- Small handle - convenient in small areas
- Rubber handle grips
- Part no. 50008 has a pull-out handle design which provides increased leverage. At 500 MCM, this tool requires less handle load than 250MCM tools require.



PVC SCH. 40 ELECTRICAL CONDUIT - UL APPROVED

PVC SCH. 40 CONDUIT

Part No.	Size	Description	Price / 10 Ft.
A52AE12	1/2" x 10'	PVC Sch. 40 Conduit - Belled End	
A52AG12	3/4" x 10'	PVC Sch. 40 Conduit - Belled End	
A52BA12	1" x 10'	PVC Sch. 40 Conduit - Belled End	
A52BC12	1-1/4" x 10'	PVC Sch. 40 Conduit - Belled End	
A52BE12	1-1/2" x 10'	PVC Sch. 40 Conduit - Belled End	
A52CA12	2" x 10'	PVC Sch. 40 Conduit - Belled End	

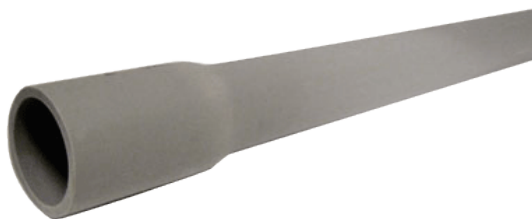

PVC SCH. 40 ELECTRICAL FITTINGS - UL & CSA APPROVED

COUPLINGS

Part No.	Size	Description	Box Qty.	Price
CP05	1/2"	UL Coupling	150	
CP07	3/4"	UL Coupling	100	
CP10	1"	UL Coupling	50	
CP12	1-1/4"	UL Coupling	30	
CP15	1-1/2"	UL Coupling	25	
CP20	2"	UL Coupling	30	



MALE ADAPTERS

Part No.	Size	Description	Box Qty.	Price
TA05	1/2"	UL Male Adapter	150	
TA07	3/4"	UL Male Adapter	125	
TA10	1"	UL Male Adapter	50	
TA12	1-1/4"	UL Male Adapter	50	
TA15	1-1/2"	UL Male Adapter	25	
TA20	2"	UL Male Adapter	50	



FEMALE ADAPTERS

Part No.	Size	Description	Box Qty.	Price
FA05	1/2"	UL Female Adapter	150	
FA07	3/4"	UL Female Adapter	100	
FA10	1"	UL Female Adapter	50	
FA12	1-1/4"	UL Female Adapter	30	
FA15	1-1/2"	UL Female Adapter	25	
FA20	2"	UL Female Adapter	30	



90° ELBOWS - PLAIN END

Part No.	Size	Description	Box Qty.	Price
40STD0590	1/2"	UL 90° Bend - Std. Radius	40	
40STD0790	3/4"	UL 90° Bend - Std. Radius	40	
40STD1090	1"	UL 90° Bend - Std. Radius	50	
40STD1290	1-1/4"	UL 90° Bend - Std. Radius	25	
40STD1590	1-1/2"	UL 90° Bend - Std. Radius	20	
40STD2090	2"	UL 90° Bend - Std. Radius	15	



90° ELBOWS - BELLED END

Part No.	Size	Description	Box Qty.	Price
B40STD0590	1/2"	UL 90° Bend - Std. Radius	40	
B40STD0790	3/4"	UL 90° Bend - Std. Radius	40	
B40STD1090	1"	UL 90° Bend - Std. Radius	40	
B40STD1290	1-1/4"	UL 90° Bend - Std. Radius	20	
B40STD1590	1-1/2"	UL 90° Bend - Std. Radius	20	
B40STD2090	2"	UL 90° Bend - Std. Radius	15	



EMT CONDUIT

EMT METAL CONDUIT

Part No.	Size	Description	Bundle	Price / Ft.
EMT050	1/2" x 10'	EMT Metal Conduit	100'	
EMT075	3/4" x 10'	EMT Metal Conduit	100'	
EMT100	1" x 10'	EMT Metal Conduit	100'	
EMT125	1-1/4" x 10'	EMT Metal Conduit	50'	
EMT150	1-1/2" x 10'	EMT Metal Conduit	50'	
EMT200	2" x 10'	EMT Metal Conduit	30'	



EMT COMPRESSION RAIN TITE FITTINGS

EMT COMPRESSION RAIN TITE CONNECTOR

Part No.	Size	Description	Box Qty.	Price
650S	1/2"	Rain Tite Connector	50	
651S	3/4"	Rain Tite Connector	25	
652	1"	Rain Tite Connector	25	
653	1-1/4"	Rain Tite Connector	10	
654	1-1/2"	Rain Tite Connector	10	
655	2"	Rain Tite Connector	5	



EMT COMPRESSION RAIN TITE COUPLING

Part No.	Size	Description	Box Qty.	Price
660S	1/2"	Rain Tite Coupling	50	
661S	3/4"	Rain Tite Coupling	25	
662	1"	Rain Tite Coupling	25	
663	1-1/4"	Rain Tite Coupling	10	
664	1-1/2"	Rain Tite Coupling	10	
665	2"	Rain Tite Coupling	5	



MOUNTING ACCESSORIES

WEATHER HEADS

Part No.	Size	Description	Price
EC050	1/2"	Weather Head	
EC075	3/4"	Weather Head	
EC100	1"	Weather Head	
EC125	1-1/4"	Weather Head	
EC150	1-1/2"	Weather Head	
EC200	2"	Weather Head	



DISCONNECT HUB

Part No.	Size	Description	Price
ECHS075	3/4"	Disconnect Hub - Type 3R	
ECHS100	1"	Disconnect Hub - Type 3R	
ECHS125	1-1/4"	Disconnect Hub - Type 3R	
ECHS150	1-1/2"	Disconnect Hub - Type 3R	
ECHS200	2"	Disconnect Hub - Type 3R	



PUMP PANEL AND METER BASE HUB

Part No.	Size	Description	Price
EC38595	-	Blank Hub	
EC38596	1"	Hub for Pump Panel and Meter Base	
EC38597	1-1/4"	Hub for Pump Panel and Meter Base	
EC38598	1-1/2"	Hub for Pump Panel and Meter Base	
EC38599	2"	Hub for Pump Panel and Meter Base	



Note: Steel Lock Nuts, if needed, can be located in Section 13, Hardware.

1. ELECTRICAL
 2. PUMP ACC.
 3. HOSE, PE PIPE & ACC.
 4. IPS, PIP PIPE & ACC.
 5. SURFACE
 6. SPRINKLERS
 7. TRAVELER & WHEEL MOVE
 8. PIVOT
 9. TURF
 10. LOW VOLUME
 11. FILTERS
 12. INJECTION
 13. HARDWARE
 INDEX

MIDWEST TERMINAL BOX HUB

Part No.	Size	Description	Price
B12	1-1/4"	Terminal Box Hub	
B15	1-1/2"	Terminal Box Hub	
B20	2"	Terminal Box Hub	



PLASTIC BUSHING

Part No.	Size	Description	Price
PB100	1"	Plastic Bushing	
PB125	1-1/4"	Plastic Bushing	
PB150	1-1/2"	Plastic Bushing	
PB200	2"	Plastic Bushing	



STEEL LOCK RINGS

Part No.	Size	Description	Price
LN100	1"	Steel Lock Rings	
LN125	1-1/4"	Steel Lock Rings	
LN150	1-1/2"	Steel Lock Rings	
LN200	2"	Steel Lock Rings	



REDUCING WASHERS

Part No.	Size	Description	Price
RW21	3/4" x 1/2"	Reducing Washers	
RW31	1" x 1/2"	Reducing Washers	
RW32	1" x 3/4"	Reducing Washers	
RW41	1-1/4" x 1/2"	Reducing Washers	
RW42	1-1/4" x 3/4"	Reducing Washers	
RW43	1-1/4" x 1"	Reducing Washers	
RW51	1-1/2" x 1/2"	Reducing Washers	
RW52	1-1/2" x 3/4"	Reducing Washers	
RW53	1-1/2" x 1"	Reducing Washers	
RW54	1-1/2" x 1-1/4"	Reducing Washers	
RW61	2" x 1/2"	Reducing Washers	
RW62	2" x 3/4"	Reducing Washers	
RW63	2" x 1"	Reducing Washers	
RW64	2" x 1-1/4"	Reducing Washers	
RW65	2" x 1-1/2"	Reducing Washers	
RW71	2-1/2" x 1/2"	Reducing Washers	
RW72	2-1/2" x 3/4"	Reducing Washers	
RW73	2-1/2" x 1"	Reducing Washers	
RW74	2-1/2" x 1-1/4"	Reducing Washers	
RW75	2-1/2" x 1-1/2"	Reducing Washers	
RW76	2-1/2" x 2"	Reducing Washers	
RW81	3" x 1/2"	Reducing Washers	
RW82	3" x 3/4"	Reducing Washers	
RW83	3" x 1"	Reducing Washers	
RW84	3" x 1-1/4"	Reducing Washers	
RW85	3" x 1-1/2"	Reducing Washers	
RW86	3" x 2"	Reducing Washers	
RW87	3" x 2-1/2"	Reducing Washers	



NON-METALLIC FLEXIBLE CONDUIT & FITTINGS

NON-METALLIC PVC FLEXIBLE CONDUIT

Part No.	Description	Price
165007	1/2" x 100' Plastic Flex Conduit	
165009	3/4" x 100' Plastic Flex Conduit	
165011	1" x 100' Plastic Flex Conduit	
165014	1-1/4" x 100' Plastic Flex Conduit	
165017	1-1/2" x 50' Plastic Flex Conduit	
165021	1-1/2" x 100' Plastic Flex Conduit	
165020	2" x 50' Plastic Flex Conduit	



NON-METALLIC STRAIGHT MALE ADAPTER

Part No.	Description	Price
LTS10	1/2" MIPT Straight Plastic Connector	
LTS15	3/4" MIPT Straight Plastic Connector	
LTS20	1" MIPT Straight Plastic Connector	
LTS25	1-1/4" MIPT Straight Plastic Connector	
LTS30	1-1/2" MIPT Straight Plastic Connector	
LTS35	2" MIPT Straight Plastic Connector	

NON-METALLIC MIPT X 90° ELBOW CONNECTOR

Part No.	Description	Price
LTB10/90	1/2" MIPT x 90° Plastic Elbow	
LTB15/90	3/4" MIPT x 90° Plastic Elbow	
LTB20/90	1" MIPT x 90° Plastic Elbow	
LTB25/90	1-1/4" MIPT x 90° Plastic Elbow	
LTB30/90	1-1/2" MIPT x 90° Plastic Elbow	
LTB35/90	2" MIPT x 90° Plastic Elbow	

METALLIC FLEXIBLE CONDUIT & METALLIC FITTINGS

METALLIC FLEXIBLE CONDUIT W/ PVC COVER

Part No.	Description	Price
39412	1/2" x 100' Metallic Flex Conduit	
39422	3/4" x 100' Metallic Flex Conduit	
39431	1" x 100' Metallic Flex Conduit	
39441	1-1/4" x 50' Metallic Flex Conduit	
39451	1-1/2" x 50' Metallic Flex Conduit	
39461	2" x 50' Metallic Flex Conduit	



METALLIC STRAIGHT MALE ADAPTER

Part No.	Description	Price
STR50	1/2" MIPT Straight Metallic Connector	
STR75	3/4" MIPT Straight Metallic Connector	
STR100	1" MIPT Straight Metallic Connector	
STR125	1-1/4" MIPT Straight Metallic Connector	
STR150	1-1/2" MIPT Straight Metallic Connector	
STR200	2" MIPT Straight Metallic Connector	

METALLIC MIPT X 90° ELBOW CONNECTOR

Part No.	Description	Price
STR5090	1/2" MIPT x 90° Metallic Elbow	
STR7590	3/4" MIPT x 90° Metallic Elbow	
STR10090	1" MIPT x 90° Metallic Elbow	
STR12590	1-1/4" MIPT x 90° Metallic Elbow	
STR15090	1-1/2" MIPT x 90° Metallic Elbow	
STR20090	2" MIPT x 90° Metallic Elbow	

1. ELECTRICAL 2. PUMP Acc. 3. HOSE, PE PIPE & Acc. 4. IPS, PIP Pipe & Acc. 5. SURFACE 6. SPRINKLERS 7. TRAVELER & WHEEL MOVE 8. PIVOT 9. TURF 10. LOW VOLUME 11. FILTERS 12. INJECTION 13. HARDWARE INDEX

PHASE PERFECT® DIGITAL PHASE CONVERTERS

Phase Perfect digital phase converters are used to convert Single Phase 240VAC to Three Phase 240VAC. They are built with the latest advances in solid state power switching technology. It truly is a phase converter unlike any other.

Phase Perfect can operate all types of three-phase equipment, including voltage sensitive equipment, without worrying about damage from voltage unbalance.

High efficiency conserves energy and reduces demand on the single-phase service.

Compared to other phase converters, Phase Perfect is lighter in weight, quieter and easier to install.

Phase Perfect is the affordable, convenient alternative to utility three-phase power for CNC machines, Submersible pumps, HVAC, Elevators, Food Service, Medical Equipment, Woodworking, Winemaking, Agriculture, Broadcasting, Automotive, Printing, Drilling, Compressors, Welding, Robotic Dairy Equipment, EDM machines...and more!



Phase Perfect® Block Diagram

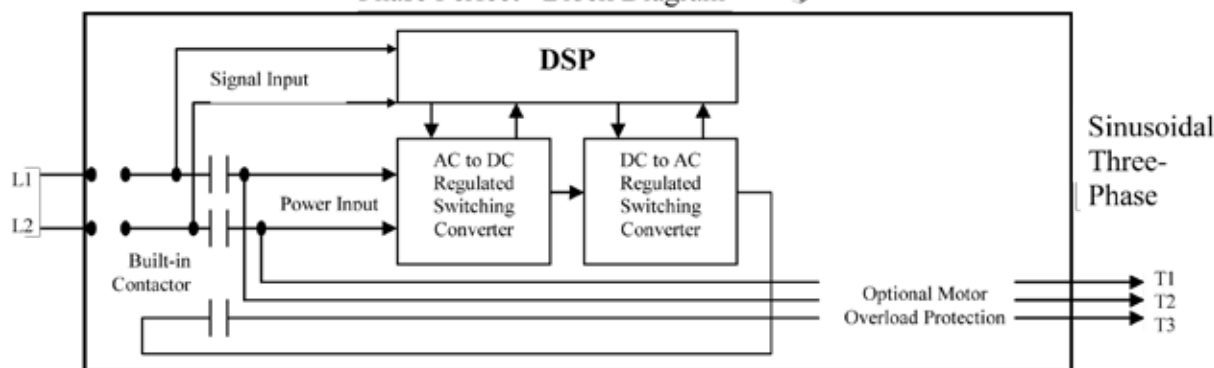

Phase Perfect digital phase converters are based on a unique, patented design that utilizes IGBT double-conversion technology. Proprietary software in the digital signal processor (DSP) precisely controls the power switching process to generate clean, balanced three-phase power suitable for powering virtually any three-phase equipment.

Phase Perfect balances phase-to-phase voltage within 1% under all load conditions.

IEEE RECOMMENDATION ON MOTORS AND VOLTAGE BALANCE

Voltage Imbalance In Percent	De-rate Motor to These Percentages of the Motor's Rating
1%	98%
2%	95%
3%	88%
4%	82%
5%	75%



Balanced three-phase voltage is important for the safe, efficient operation of three-phase equipment of all types, even simple three-phase motors. Unbalanced voltage can cause loss of power, poor efficiency and even damage to three phase equipment!

SPECIFICATIONS

Model	PT330	PT355	PT380
Rated HP	10	20	30
Output Power*	15 KVA	26 KVA	40 KVA
Input Voltage	187 V to 255V		
Phase to Phase Voltage Balance**	Better than 1%		
Maximum Steady State Output	36 amps	64 amps	96 amps
Momentary Overload Current, 4 Seconds	150 amps	280 amps	400 amps
Output Voltage	Equal to input voltage		
Stand-by Power Consumption	100 watts	240 watts	400 watts
Efficiency	97% typical		
Enclosure	Type 1 Indoor or 3R Rain Proof		
Weight	120 Lbs.	150 Lbs.	180 Lbs.
Dimensions (H x W x D in.)	wall mount	wall mount	wall mount
Type 1 Indoor	20 x 15 x 13	26 x 19 x 14	32 x 24 x 13
Type 3R Rainproof	23 x 15 x 16	30 x 19 x 14	37 x 24 x 18

* Approximate, at 240V

** NEMA MG1 Standard for Voltage Balance

Part No.	Rated HP*	Output Power	Price
PT330	10 HP	15KVA	
PT355	20 HP	26KVA	
PT380	30 HP	40KVA	

* Approximate, at 240V

AGP SERIES VARIABLE FREQUENCY DRIVES (VFD)

Regenerative Design

APG Series Variable Frequency Drives (VFD) are inverter-based devices that convert single-phase input to three-phase variable frequency output to provide speed control for three-phase AC motors. The drives have regenerative capability, allowing regenerative power from the load to pass through the converter back to the line-side power source.

Save Energy

Rather than burn regenerative power through a braking resistor, the APG Series regenerative drive puts the power back onto the line. Returning the regenerative power to the source will reduce the total power consumption of the load, saving money through reduced electrical power usage and also simplifying the installation by eliminating the braking resistor.

Phase Conversion

Traditional three-phase regenerative drives cannot function as a phase converter. APG Series drives are purpose-built phase converting drives, and doubling the HP of the drive relative to motor HP is not required. Regenerative three-phase loads can now be connected to a single-phase source with all the benefits of a regenerative drive.

Voltage Conversion

Active switching control of the line-side module allows the drive to convert 240V single-phase input to 480V three-phase output. Some models can be specified with either a 240V or 480V line-side converter. The load-side inverter is rated 480V on all models. Voltage doubling can realize significant savings from reduced wire size in long motor lead applications. This feature also allows connection of a 480V three-phase wind turbine to a 240V single-phase grid.

Low Harmonics

Electronic power factor correction produces a sine-wave line-side current, greatly reducing the current distortion and line harmonics. Because of its favorable harmonic profile, input line reactors and harmonic filters are not required on the line side of an APG Series drive. Models are available with either an LC filter or an LCL filter. The LCL filter produces cleaner wave forms with lower harmonic distortion. Installations will comply with IEEE 519, the international standard for allowable harmonic distortion on utility mains.

240V INPUT MODELS

Model	HP Rating	Rated Output kW	Rated Input Voltage	Rated Input Current	Rated Output Voltage	Rated Output Current	1 out (10 sec)*	1 out (1 sec)**	Price
APG220	20	20.9	240	97	480	30	40	50	
APG230	30	31.1	240	144	480	45	59	73	

480V INPUT MODELS

Model	HP Rating	Rated Output kW	Rated Input Voltage	Rated Input Current	Rated Output Voltage	Rated Output Current	1 out (10 sec)*	1 out (1 sec)**	Price
APG420	20	20.9	480	48	480	30	40	50	
APG430	30	31.1	480	72	480	45	59	73	
APG440	40	42.4	480	98	480	61	82	102	
APG450	50	52.2	480	121	480	77	101	125	
APG460	60	61.7	480	143	480	91	121	149	
APG475	75	73.5	480	170	480	107	141	174	

*150% of rated current for 10 seconds out of every 60 seconds

**185% of rated current for 1 second out of every 60 seconds

Output as v/f control or sensorless vector control

Interface

Keypad and display mounted on enclosure or mounted remotely and connected by extension cable. Functions include:

- Display of normal operating parameters
- Read measured values
- Fault log
- Timers
- Setting adjustable parameters
- Hand/Off/Auto (HOA) controls

Digital and Analog I/O including:

- Digital signal indicating drive fault
- Digital inputs for drive run signal
- 0-5 VDC output indicating motor torque
- 0-5 VDC output indicating motor speed
- 0-5 VDC input to control motor speed
- 4-20 mA input for motor speed control
- MODBUS RTU 19.2 KBPS or higher, RS-485 (4 wire)

Utilities

- Windows based software to monitor and configure the drive via RS-485 (4 wire) MODBUS or Ethernet protocol

Control Algorithms

- Digital constant pressure system control
- Analog constant pressure system control
- V/f control or space-vector torque control
- Wind turbine optimization parameters

Environmental

- Operating ambient temperature range: -10 to 50° C
- Enclosure: Type 1 indoor with optional flange mount, small Type 3R outdoor, or large Type 3R outdoor with sub-panel for integration of additional components by 508 panel shop



EATON / CUTLER-HAMMER - DISCONNECT SWITCH

Rugged indoor/outdoor Nema 3R enclosure protects against the harshest weather.

NON-FUSIBLE DISCONNECTS - 3 Pole, 480VAC / 600VAC / 250VDC

Part No.	Size	Description	Price
DH361URK	30 AMP	Heavy Duty Non-Fused Safety Switch	
DH362URK	60 AMP	Heavy Duty Non-Fused Safety Switch	
DH363URK	100 AMP	Heavy Duty Non-Fused Safety Switch	
DH364URK	200 AMP	Heavy Duty Non-Fused Safety Switch	

FUSIBLE DISCONNECTS - 3 Pole, 3 Fuse, 480VAC / 600VAC / 250VDC

Part No.	Size	Description	Price
DH361FRK	30 AMP	Heavy Duty Fused Safety Switch	
DH362FRK	60 AMP	Heavy Duty Fused Safety Switch	
DH363FRK	100 AMP	Heavy Duty Fused Safety Switch	
DH364FRK	200 AMP	Heavy Duty Fused Safety Switch	
DH365FRK	400 AMP	Heavy Duty Fused Safety Switch	

FUSIBLE DISCONNECT WITH NEUTRAL - 3 Pole, 3 Fuse, 480VAC / 600VAC / 250VDC

Part No.	Size	Description	Price
DH361NRK	30 Amp	Fusible Disconnects	
DH362NRK	60 Amp	Fusible Disconnects	
DH363NRK	100 Amp	Fusible Disconnects	
DH364NRK	200 Amp	Fusible Disconnects	

FUSIBLE DISCONNECTS - 2 Pole, 2 Fuse, 240VAC / 250VDC

Part No.	Size	Description	Price
DH221NGK	30 AMP	Nema 1 Enclosure Indoor	
DH222NGK	60 AMP	Nema 1 Enclosure Indoor	
DH221NRK	30 AMP	Nema 3R Enclosure Rainproof Outdoor	
DH222NRK	60 AMP	Nema 3R Enclosure Rainproof Outdoor	

DISCONNECTS ENCLOSURE DIMENSIONS - CLOSED DOOR

480/600VAC		240VAC/250VDC	
Part No.	H x W x D	Part No.	H x W x D
DH361	15.88" x 8.13" x 5.25"	DH221NGK	10.69" x 6.38" x 3.75"
DH362	15.88" x 8.13" x 5.25"	DH222NGK	14.19" x 8.69" x 4.21"
DH363	21.69" x 11.13" x 5.25"	DH221NRK	10.81" x 6.38" x 3.75"
DH364	27.63" x 16" x 6.14"	DH222NRK	14.38" x 8.69" x 4.21"
DH365	45.49" x 23" x 7.27"		

H = Height, W= Width, D= Depth

PLATE TYPE HUB FOR NEMA 3R ENCLOSURES (UP TO 200A)

Part No.	Size	Description	Price
DS125H1	1-1/4"	Plate Hub for DH 30 AMP to 100 AMP	
DS150H1	1-1/2"	Plate Hub for DH 30 AMP to 100 AMP	
DS200H2	2"	Plate Hub for DH 200 AMP	



Made in the USA
Weather Proof Cabinet
UL Approved

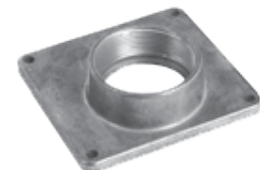

SIEMENS SAFETY SWITCHES - OUTDOOR TYPE 3R

- Tough and durable metal cabinet construction that adds rigidity and strength. The enclosure's metal edges and corners have been rolled to minimize cuts, nicks and scrapes to the installer's hands and insulated conductors.
- Rugged metal handle with large red grip which provides highly visible On/Off indication.
- Generous wire gutters that meet and/or exceed UL and NEC wire bending space requirements.
- Highly visible blades and enhanced double-break technology.
- Spring reinforced fuse clips that assure reliable contact for cool operation.
- Front removable mechanical lugs that are field convertible to copper mechanical lugs or compression (crimp) connectors.
- A hinged clear line terminal shield with probe holes for inspecting or testing line side terminals.
- The enclosure offers tangential knockouts for easy conduit line up and two or three point mounting, and a door that opens greater than 180°.
- With easy to install replacement part kits, every part is replaceable - including load and line bases, the handle and even the operating mechanism.
- The rugged metal handle can be padlocked in the off position with up to 3 padlocks with 5/16" hasps.

SIEMENS FUSIBLE SAFETY SWITCH

3 Pole, 3 Fuse, 480VAC / 600VAC / 250VDC

Part No.	Size	Description	Price
HF361RL	30 AMP	Fusible Safety Switch Oversized Enclosure	
HF361R	30 AMP	Fusible Safety Switch	
HF362RL	60 AMP	Fusible Safety Switch Oversized Enclosure	
HF362R	60 AMP	Fusible Safety Switch	
HF363R	100 AMP	Fusible Safety Switch	
HF364R	200 AMP	Fusible Safety Switch	



SIEMENS NON-FUSIBLE SAFETY SWITCH

3 Pole, 480VAC / 600VAC / 250VDC

Part No.	Size	Description	Price
HNF361RL	30 AMP	Non-Fusible Safety Switch Oversized Enclosure	
HNF361R	30 AMP	Non-Fusible Safety Switch	
HNF362R	60 AMP	Non-Fusible Safety Switch	
HNF363R	100 AMP	Non-Fusible Safety Switch	
HNF364R	200 AMP	Non-Fusible Safety Switch	

ENCLOSURE DIMENSIONS - CLOSED DOOR

Fusible		Non-Fusible	
Part No.	H x W x D	Part No.	H x W x D
HF361RL	16.26" x 9.16" x 5.05"	HNF361RL	16.26" x 9.16" x 5.05"
HF361R	14.39" x 6.64" x 5.05"	HNF361R	11.11" x 6.64" x 5.05"
HF362R	16.26" x 9.16" x 5.05"	HNF362R	16.26" x 9.16" x 5.05"
HF363R	21.95" x 9.64" x 5.05"	HNF363R	21.95" x 9.64" x 5.05"
HF364R	29.90" x 14.61" x 6.36"	HNF364R	29.90" x 14.61" x 6.36"

H = Height, W= Width, D= Depth

Note: Neutral kit available



METER BASES

METER MOUNTING EQUIPMENT, TYPE HQ, COMMERCIAL/INDUSTRIAL

Part No.	Size	Description	Price
MILU4801-XL-5T9	5 Terminal	200 Amp Meter Base 3 Phase	
MILU9701-RRL	7 Terminal	200 Amp Meter Base 3 Phase	

METER INFORMATION

Part No.	Service	Connectors	W x H x D	Bypass
MILU4801-XL-5T9	Overhead	#6 - 350 KCMIL	13" x 19" x 5"	Lever
MILU9701-RRL	Overhead	#6 - 350 KCMIL	13" x 19" x 5.13"	Lever



POLYCARBONATE BOX ENCLOSURES

These enclosures are manufactured with a durable high impact polycarbonate. They provide protection from dust, rain, sleet, snow, waves, splashing and sprinkler directed water, with superior impact and flame protection. Accessories including Swing Panel Kits and DIN Rail Kits are available upon request.

- Best NEMA 4X non-metallic enclosure available today
- Flat lid surface for easy HMI / pilot device mounting
- Latches and hinges do not penetrate enclosure
- Enclosures with clear or opaque lids are available
- Easy to remove Lid
- High performance inserts
- Integrated lock hasp
- Molded in bosses
- Multi-directional mounting feet
- Rated IP68 / Type 3R, 4, 4X, 12 / F1 UV-light / 5VA Flammability / UL 1741 Compliant

POLYCARBONATE BOX ENCLOSURES - OPAQUE COVER

Part No.	Size	Description	Price
AH664	6" x 6" x 4"	Opaque Cover Enclosure	
AH864	8" x 6" x 4"	Opaque Cover Enclosure	
AH1084	10" x 8" x 4"	Opaque Cover Enclosure	
AH12106	12" x 10" x 6"	Opaque Cover Enclosure	
AH14126	14" x 12" x 6"	Opaque Cover Enclosure	
AH16148	16" x 14" x 8"	Opaque Cover Enclosure	
AH181610	18" x 16" x 10"	Opaque Cover Enclosure	
AH242410	24" x 24" x 10"	Opaque Cover Enclosure	



POLYCARBONATE BOX ENCLOSURES - CLEAR COVER

Part No.	Size	Description	Price
AH664C	6" x 6" x 4"	Clear Cover Enclosure	
AH864C	8" x 6" x 4"	Clear Cover Enclosure	
AH1084C	10" x 8" x 4"	Clear Cover Enclosure	
AH12106C	12" x 10" x 6"	Clear Cover Enclosure	
AH14126C	14" x 12" x 6"	Clear Cover Enclosure	
AH16148C	16" x 14" x 8"	Clear Cover Enclosure	
AH181610C	18" x 16" x 10"	Clear Cover Enclosure	
AH242410C	24" x 24" x 10"	Clear Cover Enclosure	



ALUMINUM BACK PLATE

Part No.	Size	Description	Price
BP66A	6" x 6"	Aluminum Back Plate	
BP86A	8" x 6"	Aluminum Back Plate	
BP108A	10" x 8"	Aluminum Back Plate	
BP1210A	12" x 10"	Aluminum Back Plate	
BP1412A	14" x 12"	Aluminum Back Plate	
BP1614A	16" x 14"	Aluminum Back Plate	
BP1816A	18" x 16"	Aluminum Back Plate	
BP2424A	24" x 24"	Aluminum Back Plate	

TERMINAL BOXES

MIDWEST TERMINAL BOX

Part No.	Size	Description	Price
T3610	100 AMP	Terminal Box - 3 Phase	
T3620	200 AMP	Terminal Box - 3 Phase	
T3640UL	400 AMP	Terminal Box - 3 Phase	



JUNCTION BOXES

NEMA 3R RAIN TITE JUNCTION BOX ENCLOSURE

Part No.	Size	Description	Price
664RTSC	6" x 6" x 4"	Rain Tite Enclosure	
884RTSC	8" x 8" x 4"	Rain Tite Enclosure	
886RTSC	8" x 8" x 6"	Rain Tite Enclosure	
12126RTSC	12" x 12" x 6"	Rain Tite Enclosure	
12186RTSC	12" x 18" x 6"	Rain Tite Enclosure	
18186RTSC	18" x 18" x 6"	Rain Tite Enclosure	



GE TERMINAL BLOCKS

One piece Phenolic molded terminal boards for use in wiring of control panels. Terminal boards may be mounted end to end without spacing and terminals will accept wire sizes through #10AWG. The electrical rating is 30 AMP, 600Volt. A write-on 15/32" wide marking strip, markable with ink or pencil, and a clear finger safe cover is provided.

Part No.	Model	Description	Price
151B46AF	314212(VAL)	4 Point Terminal Block	
	09-7604-3(ZIM)		
	93809 (NI)		
151B66AF	09-9059-8(ZIM)	6 Point Terminal Block	
151B26AF	09-7602-7(ZIM)	12 Point Terminal Block	
	93803(NI)		

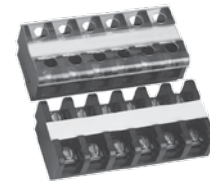

POWER DISTRIBUTION BLOCKS

MARATHON POWER DISTRIBUTION BLOCKS

Part No.	Model	Description	Price
1423553	09-9172-9(ZIM)	3 Pole Power Splicer Block	

3 Pole Power Splicer Block - 175 Amp Copper Wire, 135 Amp Aluminum Wire - 600 Volts AC/DC

Wire Range: Line Side (1) 2/0 - #14 AWG
Load Side (1) 1/4 - 20 Tapped Hole

Clear protective plastic cover and white vinyl strip to mark circuits included.



BUSSMANN POWER DISTRIBUTION BLOCKS - FINGER SAFE

Part No.	Description	Price
PDBFS204	175AMP LINE (1)2/0-8AWG LOAD (1)2/0-8AWG	
PDBFS220	175AMP LINE (1)2/0-8AWG LOAD(4) 4-14 AWG	
PDBFS303	310AMP LINE (1)350-6AWG LOAD(1)350-6 AWG	
PDBFS330	380AMP LINE (1)500-6AWG LOAD(6)2-4AWG	
PDBFS377	570AMP LINE (2)300-4AWG LOAD(12)4-14AWG	
PDBFS500	620AMP LINE (2)350-4AWG LOAD(2)350-4AWG	
PDBFS504	760AMP LINE (2)500-6AWG LOAD(2)500-6AWG	

600V High SCCR 200KA rating

UL listed

Din rail mount and panel mount

Interlockable



INTRO 1. ELECTRICAL 2. PUMP Acc. 3. HOSE, PE PIPE & Acc. 4. IPS, PIP Pipe & Acc. 5. SURFACE 6. SPRINKLERS 7. TRAVELER & WHEEL MOVE 8. PIVOT 9. TURF 10. LOW VOLUME 11. FILTERS 12. INJECTION 13. HARDWARE INDEX

RELAYS

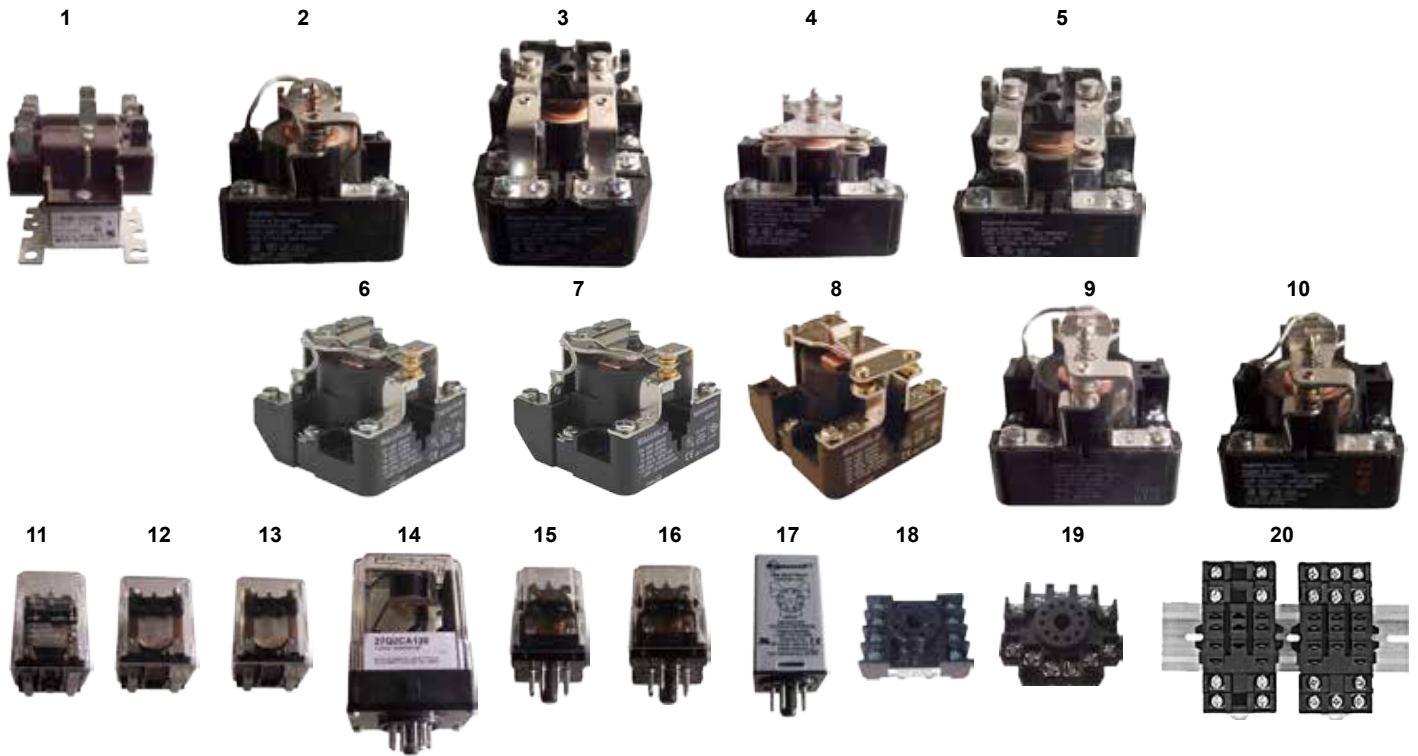

RELAYS

Part No.	Item	Description	Price
9100233T99	1	PU GENERAL PURPOSE RELAY, DPDT, 120 VAC	
PRD5AYO480	2	P & B POWER RELAY, SPDT, 480VAC 50/60 HZ 25A 277VAC 1HP 120VAC 2HP 250VAC 10A 600VAC 7A 50VAC RESISTIVE	
PRD11AGO120VAC	3	P & B POWER RELAY, DPDT, 120VAC 50/60HZ 30A 240VAC 20A 277VAC 10A 600VAC VAL 314727	
PRD3AGO120	4	P & B POWER RELAY, SPST, 120 VAC 50/60HZ, 30 A 277VAC RESISTIVE, 1.5HP 120VAC, 2 HP 250VAC, 10 AMP 600VAC	
PRD7AYO120VAC	5	P & B POWER RELAY, DPST, 1HP - 120VAC 25A 240VAC 50/60HZ - ZIM9-9179-4	
8501CO15V20	6	Square D RELAY, 600VAC 5AMP Type C +Options 1-Phase, 30A, SPDT, 120VAC@50/60Hz, 1-1/2HP	
8501CO15V14	7	Square D RELAY, 600VAC 5AMP Type C +Options 1-Phase, 30A, SPDT, 24VAC@50/60Hz, 1-1/2HP	
8501CO6V20	8	Square D RELAY, 120VAC 5AMP Type C +Options, 1-Phase, 30A, SPST, 120VAC@50/60Hz, 1-1/2HP	
PRD5AYO120VAC	9	P & B POWER RELAY, SPDT, 120 VAC 50/60 HZ 25A 277VAC 10A 600VAC - ZIM 9-9142-2M	
PRD5AYO24VAC	10	P & B POWER RELAY SPDT, 24VAC 50/60HZ 25A 277VAC 10A 240VAC - ZIM 9-8890-7	
KUL11A15S120VAC	11	P & B ICE CUBE RELAY, 9 BLADE, 120VAC 50/60HZ 25A 277VAC 10A 600VAC - ZIM 10-0161-9	
KUP11D15110VDC	12	P & B ICE CUBE RELAY, 8 BLADE, 110VDC 3A 600VAC 10A 240VAC - VAL 315559	
KUP11D1512VDC	13	P & B ICE CUBE RELAY, 8 BLADE, 12 VDC COIL 1/3HP 120VAC 10A 240VAC, VAL 099PO16, LW40-741	
27Q2CA120	14	Eagle LATCHING RELAY, 11PIN - 120V 50/60 HZ 10A 120VAC RESISTIVE - ZIM 9-8955-8	
KRPA11AN024VAC	15	P & B ICE CUBE RELAY, 8 PIN, 24VAC 50/60HZ 1/3HP 120VAC 1/2HP 10A 240VAC	
KRPA11AN120VAC	16	P & B ICE CUBE RELAY, 8 PIN, 120V 50/60 HZ 1/3HP 120VAC 1/2HP 10A 240VAC	
TDRSOXP120V	17	Magnecraft Time Delay Relay, 8 Pin, 120VAC/VDC Input Timing Range: 0.1 Sec to 10 Hrs. Contacts: 1/3HP 120VAC, 1/2HP 240VAC, 12A 120/240VAC 30VDC	
OT08PC	18	Custom Connector Socket, 8 Pin	
OT11PC	19	Custom Connector Socket, 11 Pin	
ST11PC	20	Custom Connector Socket, 11 Blade Works with 8 or 11 Blades	

CONTACTORS



CUTLER HAMMER CONTACTORS

Part No.	Item	Description	Price
C320KG3	1	1-NO,1-NC Aux Contact for 15-75 AMP C25 Contactor, Stackable	
C25DND325A	2	Cutler Hammer 3 Pole Non-reversing Contactors, 25A, 110 - 120VAC	
C25DND330A	3	30 AMP 3-Pole Tower Contactor 120V	
C25DND330C	4	30 AMP 3-Pole Tower Contactor 480V	
C25DND340A	5	40 AMP 3-Pole Tower Contactor 120V	
C25ENC430A	6	30 AMP 4-Pole Panel Contactor 120V	

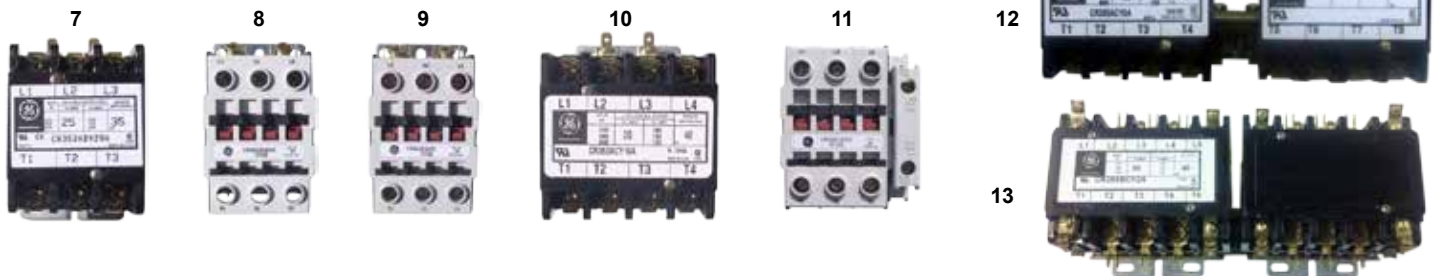

GE CONTACTORS

Part No.	Item	Description	Price
CR353ABY29A	7	GE 3 Pole Tower Contactor, 120VAC, 25 FL AMPS VAL 314667, ZIM 9-0866-5, LW L-40-246	
CR453AB3AMMP	8	GE 3 Pole Tower Contactor, 120VAC, 25 FL AMPS (New Style) VAL 314667, ZIM 9-0866-5, LW L-40-246	
CR453AC3ADDP	9	GE 3 Pole W/Lugs Contactor, 120VAC, 30 FL AMPS (Replaces CR353AC3DA1) VAL 314598, LW L-40-602	
CR353ACY16A	10	GE 4 Pole Panel Contactor, 120 VAC, 30 FL AMPS VAL 99P013, ZIM 9-0860-8	
CR453AC3ADDP W/ BCLL11	11	GE 4 Pole Panel Contactor, 120VAC (Replaces CR353ACY16A) Add BCLL11 Side Mount Auxiliary Contact VAL 99P013, ZIM 9-0860-8	
EB340R	12	GE 4-POLE REVERSER CR355ACY6A (OLD STYLE)	
EB430R	13	GE 3-POLE REVERSER W/AUX CR355BCY2A (OLD STYLE)	
CR455AC3AMMD22FP	14	GE 4 Pole Reversing Contactor, 120VAC, 30 FL AMPS (Replaces CR355ACY7A) ZIM 9-0864-0	
CR353XAAA	15	GE 353 Series Side Mount Auxiliary Contact Block, 1NO - 1NC	
BCLF10	16	GE 453 Series Front Mount Auxiliary Contact Block, 1NO	
BCLF01	17	GE 453 Series Front Mount Auxiliary Contact Block, 1NC	
BCLL11	18	GE 453 Series Side Mount Auxiliary Contact Block, 1NO-1NC	
BCLL20	19	GE 453 Series Side Mount Auxiliary Contact Block, 2NO	



SQUARE D CONTACTORS

Part No.	Item	Description	Price
8910DPA23V02	20	SD 25 AMP 3-Pole Tower Contactor 120V Thin Metal Base	
8910DPA33V02	21	SD 30 AMP 3-Pole Tower Contactor 120V Thin Metal Base	
8910DPA23S31	22	SD 3 Pole Tower Contactor, 120VAC, 25 FL AMPS, ZIM 9-0866-5	
8910DPA34S31	23	SD 4 Pole Panel Contactor, 120VAC, 30 FL AMPS, ZIM 9-0860-8	
8910DPA44S41	24	SD 4 Pole Panel Contactor, 120VAC, 40 FL AMPS, VAL 3E1848	

INTRO 1. ELECTRICAL 2. PUMP Acc. 3. HOSE, PE PIPE & Acc. 4. IPS, PIP Pipe & Acc. 5. SURFACE 6. SPRINKLERS 7. TRAVELER & WHEEL MOVE 8. PIVOT 9. TURF 10. LOW VOLUME 11. FILTERS 12. INJECTION 13. HARDWARE INDEX

LPSC POWER SAFE FUSE HOLDER - CLASS C

Part No.	Poles	Wire Range	Price
LPSC001	1	without LED indicator	
LPSC002	2	without LED indicator	
LPSC003	3	without LED indicator	
LPSC004	4	without LED indicator	
LPSC001ID	1	with LED indicator	
LPSC002ID	2	with LED indicator	
LPSC003ID	3	with LED indicator	
LPSC004ID	4	with LED indicator	



LPSM POWER SAFE FUSE HOLDER - CLASS MIDGET

Part No.	Poles	Wire Range	Price
LPSM001	1	without LED indicator	
LPSM002	2	without LED indicator	
LPSM003	3	without LED indicator	
LPSM004	4	without LED indicator	
LPSM001ID	1	with LED indicator	
LPSM002ID	2	with LED indicator	
LPSM003ID	3	with LED indicator	
LPSM004ID	4	with LED indicator	

- Indicating and non-indicating options available
- Easy installation and fuse removal with no additional pullers or tools required
- 35 mm DIN Rail Mountable
- Ventilated design for cooler operation

CLASS M FUSE HOLDERS

Part No.	Poles	Wire Range	Fuse Selection	Price
6M30A1SPQ	1	#10 - #14	FLQ, FLA, FLM	
6M30A2SPQ	2	CU Wire	FNM, FNQ, KLQ,	
6M30A3SPQ	3	Only	KLKD, KLK, KTK	

Note: Other fuse selections include: A13X-2, A25Z-2, A60Q-2, A6Y-2B, AGU, ATM, ATQBLF, BLN, BLS, BAN, BAF, GFN, GGO, OTM, TRM

- Rated for up to 30 Amps and 600 volts
- Tested and approved for 100,000 Amp Withstand Rating and Short Circuit Withstand Rating
- Clip: Copper Alloy, Tin Plated
- Quick Connect Standard with Sems Pressure (SP)
- UL Recognized File No. IZLT2.E35113/ CSA Certified File No. LR21455
- Thermoplastic Base - RoHS Compliant



CLASS CC FUSE BLOCK

Part No.	Poles	Wire Range	Fuse Selection	Price
L60030C1PQ	1	#10 - #14	CCMR (OR)	
L60030C2PQ	2	CU Wire	KLDR (OR)	
L60030C3PQ	3	Only	KLKR	

- Rated for up to 30 Amps and 600 Volts
- These blocks offer generous space savings and enhanced value
- Universal mounting holes for easy replacement
- Rejection feature prevents the insertion of fuses with less interrupting rating or voltage ratings
- Clip: Copper Alloy, Tin Plated (design reduces resistance and heat)
- Interlocking feature allowing ganging to produce a fuseblock with any number of poles
- Pressure Plate with Quick Connect Terminal
- Covers available for all amperages to enhance safety
- UL Listed File No. E14721 / CSA Certified File No. LR7316
- Thermoplastic Base - RoHS Compliant



CLASS J FUSE BLOCK

Part No.	Amp Rating	Poles	Wire Range	Fuse Selection	Price
LFJ600301	30	1	(C) 6-14 AWG*	JTD_ID or JTD or JLS	
LFJ600302	30	2	(P) 10-14 AWG*		
LFJ600303	30	3	(S) 10-22 AWG*		
LFJ600601	60	1	2 - 4 AWG**		
LFJ600602	60	2	6 - 14 AWG**		
LFJ600603	60	3	6 - 14 AWG**		
LFJ601001	100	1	2/0 - 6 AWG**		
LFJ601003	100	3	10 - 14 AWG**		
LFJ602001	200	1	250MCM - 6**		
LFJ602003	200	3	250MCM - 6**		
LFJ604001	400	1	(2) 350MCM - 1/0**		
LFJ604003	400	3	(2) 350MCM - 1/0**		
LFJ606001	600	1	(2) 500MCM - 4**		
LFJ606003	600	3	(2) 500MCM - 4**		

*CU ONLY / **CU - AL



- Rated for 600 Volts / 0 – 600 Amps
- Space-saving design – Up to 45% smaller than existing blocks
- Universal mounting holes for easy replacement
- Indication offered on all versions except 200A – 600A
- One hand release from DIN Rail for all non-knife blade style fuses
- Reinforced fuse clips are standard on all Class J blocks rated 100A and higher
- Covers available for 100A and lower to enhance safety
- UL Listed: File No. E14721 / CSA Certified: File No. LR73091
- RoHS Compliant

CLASS R 250V FUSE BLOCK

Part No.	Amp Rating	Poles	Wire Range	Fuse Selection	Price
LFR250301	30	1	(C) 6-14 AWG*	FLNR_ID or FLNR or KLNLR or LLNRK or TLN	
LFR250302	30	2	(P) 10-14 AWG*		
LFR250303	30	3	(S) 10-22 AWG*		
LFR250601	60	1	2 - 4 AWG**		
LFR250602	60	2	6 - 14 AWG**		
LFR250603	60	3	6 - 14 AWG**		
LFR251001	100	1	2/0 - 6 AWG**		
LFR251003	100	3	10 - 14 AWG**		
LFR252001	200	1	250MCM - 6**		
LFR252003	200	3	250MCM - 6**		
LFR254001	400	1	(2) 350MCM - 1/0**		
LFR254003	400	3	(2) 350MCM - 1/0**		
LFR256001	600	1	(2) 500MCM - 4**		
LFR256003	600	3	(2) 500MCM - 4**		

*CU ONLY / **CU - AL



CLASS R 600V FUSE BLOCK

Part No.	Amp Rating	Poles	Wire Range	Fuse Selection	Price
LFR600301	30	1	(C) 6-14 AWG*	FLSR_ID or FLSR or KLSR or LLSRK_ID or LLSRK or IDSR	
LFR600302	30	2	(P) 10-14 AWG*		
LFR600303	30	3	(S) 10-22 AWG*		
LFR600601	60	1	2 - 4 AWG**		
LFR600602	60	2	6 - 14 AWG**		
LFR600603	60	3	6 - 14 AWG**		
LFR601001	100	1	2/0 - 6 AWG**		
LFR601003	100	3	8 - 14 AWG**		
LFR602001	200	1	250MCM - 6**		
LFR602003	200	3	250MCM - 6**		
LFR604001	400	1	(2) 350MCM - 1/0**		
LFR604003	400	3	(2) 350MCM - 1/0**		
LFR606001	600	1	(2) 500MCM - 4**		
LFR606003	600	3	(2) 500MCM - 4**		

*CU ONLY / **CU - AL

- Rated for 250 Volt and 600 Volts / 0 – 600 Amps
- Indication and DIN Rail mounting offered on several 250V and 600V versions
- Universal mounting holes for easy replacement
- A rejection feature built into the block, allows only Class R fuses to be inserted
- One hand release from DIN Rail for all non-knife blade style fuses
- Reinforced fuse clips are standard on all Class R fuseblocks rated 100A and higher
- Covers available for 100A and lower to enhance safety
- UL Listed File No. E14721 / CSA Certified File No. LR73091
- RoHS Compliant

FUSES

FLNR 250 VAC, FLQ 500 VAC & CCMR 600 VAC FUSES

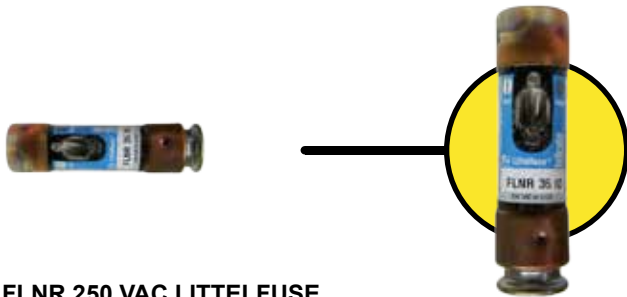

FLNR 250 VAC LITTELFUSE

Part No.	Description	Box Qty.	Price
FLNR4	250 VAC 4 AMP ID	10	
FLNR8	8 AMP	10	
FLNR10	10 AMP	10	
FLNR12	12 AMP	10	
FLNR15	15 AMP	10	
FLNR20	20 AMP	10	
FLNR25	25 AMP	10	
FLNR30	30 AMP	10	
FLNR35ID	250 VAC 35 AMP ID	10	
FLNR40ID	40 AMP	10	
FLNR45ID	45 AMP	10	
FLNR50ID	50 AMP	10	
FLNR60ID	60 AMP	10	
FLNR70ID	250 VAC 70 AMP ID	5	
FLNR80ID	80 AMP	5	
FLNR90ID	90 AMP	5	
FLNR100ID	100 AMP	5	
FLNR110ID	250 VAC 110 AMP ID	1	
FLNR150ID	150 AMP	1	
FLNR175ID	175 AMP	1	
FLNR200ID	200 AMP	1	
FLNR250ID	250 VAC 250 AMP ID	1	
FLNR300ID	300 AMP	1	

FLQ 500 VAC LITTELFUSE

Part No.	Description	Box Qty.	Price
FLQ.400	0.4 AMP	10	
FLQ1	1 AMP	10	
FLQ1.125	1-1/8 AMP	10	
FLQ1.25	1.25 Amp	10	
FLQ1.5	1.5 Amp	10	
FLQ2	2 AMP	10	
FLQ2.25	2.25 AMP	10	
FLQ2.5	2.5 AMP	10	
FLQ3	3 AMP	10	
FLQ3.2	3.2 AMP	10	
FLQ4	4 AMP	10	
FLQ5	5 AMP	10	
FLQ5.6	5.6 AMP	10	
FLQ6	6 AMP	10	
FLQ7	7 AMP	10	
FLQ8	8 AMP	10	
FLQ9	9 AMP	10	
FLQ10	10 AMP	10	
FLQ12	12 AMP	10	
FLQ15	15 AMP	10	
FLQ20	20 AMP	10	
FLQ25	25 AMP	10	
FLQ30	30 AMP	10	

GLASS BODY FUSES

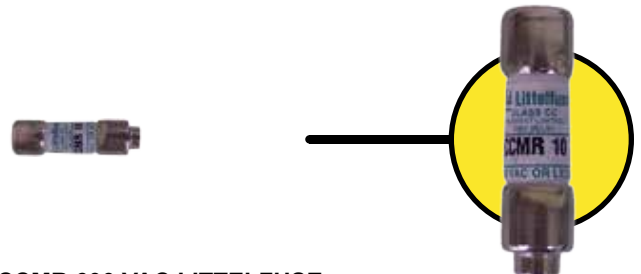

GLASS FUSE

Part No.	Description	Box Qty.	Price
03130.250VXP	1/4 AMP Glass Fuse		
03130.500VXP	1/2 AMP Glass Fuse		
03130.750VXP	3/4 AMP Glass Fuse		
031301.5VXP	1.5 AMP Glass Fuse		
0313002.VXP	2 AMP Glass Fuse		
031303.2VXP	3.2 AMP Glass Fuse		
0313004VXP	4 AMP Glass Fuse		
0313005.VXP	5 AMP Glass Fuse		

CCMR 600 VAC LITTELFUSE

Part No.	Description	Box Qty.	Price
CCMR001	1 AMP	10	
CCMR002	2 AMP	10	
CCMR002.5	2.5 AMP	10	
CCMR003	3 AMP	10	
CCMR003.2	3.2 AMP	10	
CCMR004	4 AMP	10	
CCMR005	5 AMP	10	
CCMR006	6 AMP	10	
CCMR008	8 AMP	10	
CCMR010	10 AMP	10	
CCMR012	12 AMP	10	
CCMR015	15 AMP	10	
CCMR17.5	17.5 AMP	10	
CCMR020	20 AMP	10	
CCMR025	25 AMP	10	
CCMR030	30 AMP	10	
CCMR080	80 AMP	10	

See Fuse Section Chart in section 14 for more information on choosing the correct fuses for your needs.

FLSR 600 VAC ID FUSES



JTD 600 VAC ID BOLT-IN FUSES



FLSR_ID 600 VAC LITTELFUSE

Part No.	Description	Box Qty.	Price
FLSR002ID	600 VAC 2 AMP ID	10	
FLSR02.5ID	2.5 AMP	10	
FLSR003ID	3 AMP	10	
FLSR004ID	4 AMP	10	
FLSR005ID	5 AMP	10	
FLSR05.6ID	5.6 AMP	10	
FLSR006ID	6 AMP	10	
FLSR007ID	7 AMP	10	
FLSR07.5ID	7.5 AMP	10	
FLSR008ID	8 AMP	10	
FLSR10ID	10 AMP	10	
FLSR12ID	12 AMP	10	
FLSR15ID	15 AMP	10	
FLSR17ID	17 AMP	10	
FLSR17.5ID	17.5 AMP	10	
FLSR20ID	20 AMP	10	
FLSR25ID	25 AMP	10	
FLSR30ID	30 AMP	10	
FLSR35ID	600 VAC 35 AMP ID	10	
FLSR40ID	40 AMP	10	
FLSR45ID	45 AMP	10	
FLSR50ID	50 AMP	10	
FLSR60ID	60 AMP	10	
FLSR70ID	600 VAC 70 AMP ID	5	
FLSR80ID	80 AMP	5	
FLSR90ID	90 AMP	5	
FLSR100ID	100 AMP	5	
FLSR110ID	600 VAC 110 AMP ID	1	
FLSR125ID	125 AMP	1	
FLSR150ID	150 AMP	1	
FLSR175ID	175 AMP	1	
FLSR200ID	200 AMP	1	
FLSR225ID	600 VAC 225 AMP ID	1	
FLSR250ID	250 AMP	1	
FLSR300ID	300 AMP	1	
FLSR350ID	350 AMP	1	
FLSR400ID	400 AMP	1	

JTD_ID 600 VAC (BOLT-IN) LITTELFUSE

Part No.	Description	Box Qty.	Price
OJTD-15-TXID	600 VAC 15 AMP ID	10	
OJTD-20-TXID	20AMP	10	
OJTD-25-TXID	25 AMP	10	
OJTD-30-TXID	30 AMP	10	
OJTD-35-TXID	600 VAC 35 AMP ID	10	
OJTD-40-TXID	40AMP	10	
OJTD-45-TXID	45 AMP	10	
OJTD-50-TXID	50 AMP	10	
OJTD-60-TXID	60 AMP	10	
OJTD-70-VXID	600 VAC 70AMP ID	5	
OJTD-80-VXID	80 AMP	5	
OJTD-90-VXID	90 AMP	5	
OJTD-100-VXID	100 AMP	5	
OJTD-110-XXID	600 VAC 110AMP ID	1	
OJTD-125-XXID	125 AMP	1	
OJTD-150-XXID	150 AMP	1	
OJTD-175-XXID	175 AMP	1	
OJTD-200-XXID	200 AMP	1	
OJTD-225-XXID	600 VAC 225 AMP ID	1	
OJTD-250-XXID	250 AMP	1	
OJTD-300-XXID	300 AMP	1	
OJTD-350-XXID	350 AMP	1	
OJTD-400-XXID	400 AMP	1	

See Fuse Section Chart in section 14 for more information on choosing the correct fuses for your needs.

INTRO 1. ELECTRICAL 2. PUMP Acc. 3. HOSE, PE PIPE & Acc. 4. IPS, PIP PIPE & Acc. 5. SURFACE 6. SPRINKLERS 7. TRAVELER & WHEEL MOVE 8. PIVOT 9. TURF 10. LOW VOLUME 11. FILTERS 12. INJECTION 13. HARDWARE INDEX

SF-420AC STUD SENSOR with AC DETECTION

- Battery type: 9 V alkaline
- Reliable way to detect the presence of AC voltage and to find wood or metal studs.
- Finds the edges of wood or metal studs up to 3/4" (19 mm) deep, through typical drywall construction.

Part No.	Description	Price
SF-420AC	Stud Sensor with AC Detection	



GT-11 NON-CONTACT VOLTAGE DETECTOR

- **Bright LED and audible alarm if voltage is present.**
- ON/OFF switch for longer battery life.
- Use to detect the presence of voltage at outlets, lighting fixtures, circuit breakers, wires and cables or to find a break in a wire.
- Convenient pen size fits into pocket or tool pouch.
- Replace batteries quickly by pressing the release lever and twisting the top of the tester.
- U.S. Patent #D500,799. Canadian Patent #105567.
- Lifetime Limited Warranty.

Part No.	Description	Price
GT-11	Voltage Detector	



DM-20 MANUAL RANGING MULTIMETER

- Use to measure voltage and check batteries.
- Great for measuring current of small electronic circuits.
- Includes elastomer boot to protect meter from damage.
- AC/DC voltage, DC amperage measurement.
- Resistance measurement.
- Audible continuity and diode tests.
- Tests 1.5V and 9V batteries.
- Lifetime Limited Warranty.

Part No.	Description	Price
DM-20	Manual Ranging Multimeter	



DM-65 AUTO/MANUAL RANGING MULTIMETER

- Large, easy-to-read displays
- Lifetime warranty
- Feature packed
- Amperage Rating : 10
- Capacitance : 400
- Counts : 6000
- Diode Test : Yes
- Display : Digital With Bar Graph
- Duty Cycle : 5 - 95 PCT
- Field Replaceable Fuses : Yes
- Resistance : 60
- Standard : C/US ETL Listed, CATIII, CATIV Approved
- Voltage Rating : 1000

Part No.	Description	Price
DM-65	Auto Ranging Multimeter	



CMT-80 AUTOMATIC ELECTRICAL TESTER

- Hassle-free, automatic measurement of amperage, voltage, & resistance.
- Compact design for measuring in tight spaces.
- 400A AC, 600V AC/DC measurement.
- Data hold to capture important readings.
- Auto off for longer battery life.
- Accessories included: (1) 9 V battery, test leads, carrying case.

Part No.	Description	Price
CMT-80	Automatic Electrical Tester	



CLASSIC TONE & PROBE KIT

Used to identify single conductors or cables within a bundle, at a cross-connect point or at remote ends.

Kit includes the 77HP High Power Tone Generator and the 200EP Inductive Amplifier in a rugged, woven polyester carrying case.

Part No.	Description	Price
701K	Classic Tone & Probe Kit	



24B STATION MASTER™ PRO & 24BK STATION MASTER™ PRO KIT

- Troubleshoot irrigation systems.
- Activate and cycle solenoids.
- Test solenoids for continuity.
- Send tone to identify wires.
- Measure clock voltage.
- Low battery indication.
- Easy-to-understand LEDs.
- Test leads with “Bed-of-Nails” and piercing Pin Clips.
- 1-year limited warranty.

Part No.	Description	Price
24B	Station Master Pro	
24BK	Station Master Pro Kit	



521A WIRE & VALVE LOCATOR

- Adjustable transmit power allows you to select the best signal for maximum performance.
- Transmitter’s high power output offers extended range and use on higher resistance wire paths that other locators can’t touch.
- Receiver provides both audible and visual indications of signal strength.
- Lightweight receiver wand makes it easy for you to move along quickly to locate even the longest wire path.
- Rugged headphones block ambient noise and improve “feel” for the signal.
- Includes transmitter, receiver, headset, ground stake, and complete instructions.
- Battery-operated: (8) “D” Cells and (1) 9V.
- 1-year limited warranty.

Part No.	Description	Price
521A	Wire & Valve Locator	
HS1	Headset Replacement	



INTRO 1. ELECTRICAL 2. PUMP Acc. 3. HOSE, PE PIPE & Acc. 4. IPS, PIP Pipe & Acc. 5. SURFACE 6. SPRINKLERS 7. TRAVELER & WHEEL MOVE 8. PIVOT 9. TURF 10. LOW VOLUME 11. FILTERS 12. INJECTION 13. HARDWARE INDEX

SECTION 2

PUMP ACCESSORIES

CONTENTS

2:3	WIRELESS AGRICULTURAL IRRIGATION MONITORING
2:4	FLOATING PUMPS
2:4	SOLID STATE SOFT START
2:5-7	PUMP CONTROL PANELS
2:5	EATON / CUTLER-HAMMER - PUMP PANELS
2:5	EATON / CUTLER-HAMMER - PUMP PANEL PARTS
2:6	SIEMENS PUMP CONTROL PANELS
2:7	SIEMENS PUMP PANEL PARTS
2:8	PVC PIPE
2:8	COUPLINGS
2:8	PITLESS ADAPTERS
2:9	WELL CAPS
2:9	WELL SEALS
2:10	SPRING CHECK VALVES
2:11	TANK CROSSES AND INSTALLATION PACKAGES
2:12	PRESSURE SWITCHES AND PUMP START RELAYS
2:13	MOTOR SAVERS
2:14	CYCLE STOP VALVES
2:15	TANK ACCESSORIES
2:16	PRESSURE GAUGES & ACCESSORIES
2:17	TORQUE ARRESTORS, CABLE GUARDS, ROPE & ADAPTERS
2:18	SAND SEPARATORS AND FILTERS
2:19	FILTERS
2:20-22	PRIMING PUMPS
2:22	OIL TANK & DRIPPERS
2:23-29	FLOW METERS
2:23	MCCROMETER FLOW METER
2:25	MCCROMETER VANES & FLOW TUBES
2:26	BANJO FLOW METER
2:26	DATA INDUSTRIAL FLOW METER
2:26	TEE TYPE PVC FLOW SENSORS
2:27	MULTI-JET WATER METERS
2:27	NETAFIM™ USA WATER METERS
2:30	HEAT EXCHANGERS
2:31-33	AIR & VACUUM RELIEF VALVES
2:34-35	PRESSURE RELIEF VALVES
2:36-39	BUTTERFLY VALVES
2:36	MATCO BUTTERFLY VALVES
2:37	GRAYLINE 8500 SERIES BUTTERFLY VALVES
2:37	TUF-SKIN SERIES BUTTERFLY VALVES
2:37	SPEARS PVC BUTTERFLY VALVES
2:38	BUTTERFLY EXTENSIONS
2:39	BUTTERFLY VALVE ACCESSORIES
2:39	NUT & BOLT SETS FOR BUTTERFLY VALVES
2:40-41	FLANGES
2:42-43	BUTTERFLY LINE VALVES
2:42	PLAIN END BUTTERFLY LINE VALVES
2:42	BAND & LATCH BUTTERFLY LINE VALVES
2:43	RING LOCK BUTTERFLY LINE VALVES
2:43	FLANGED BUTTERFLY LINE VALVES
2:43	PVC BUTTERFLY LINE VALVES
2:44-45	BALL VALVES
2:46	GATE VALVES
2:47	HOSE BIBBS & FROST FREE HYDRANTS



TABLE OF CONTENTS

- 2:48-51 CHECK VALVES
 - 2:48 NUT & BOLT SETS FOR WAFER CHECK VALVES
 - 2:49 PVC CHECK VALVES
 - 2:50 CLEARVIEW SIGHT CHECK VALVES
 - 2:51 CLEARVIEW SIGHT CHECK VALVES
 - 2:51 TRAVIS GALVANIZED CHECK VALVES
 - 2:51 PIERCE GALVANIZED CHECK VALVES
- 2:51-52 CHEMIGATION VALVES
 - 2:53 FOOT VALVES
- 2:54-56 CONTROL VALVES
 - 2:54 NELSON 800 SERIES CONTROL VALVES
 - 2:55 NETAFIM™ CONTROL VALVES
 - 2:56 XCAD AUTOMATIC CONTROL VALVES
- 2:57-59 FLOAT VALVES
- 2:60-61 BOLTED COUPLINGS
- 2:62-63 DISCHARGE ADAPTERS
- 2:64 FLANGED GALVANIZED FITTINGS
- 2:65-70 MALLEABLE FITTINGS
 - 2:71 MERCHANT FITTINGS
 - 2:71-73 STEEL PIPE NIPPLES
- 2:74-80 STAINLESS STEEL FITTINGS
 - 2:80 STAINLESS STEEL PIPE NIPPLES
 - 2:81 SERVICE SADDLES
 - 2:82 SUCTION FITTINGS
- 2:83-84 WELD-ON FITTINGS - ALUMINUM
 - 2:85 WELD-ON FITTINGS - STEEL BUTT WELD
- 2:86-88 BLACK WELD-ON FITTINGS - STEEL
 - 2:89 WELD-ON FITTINGS - BLACK STARTER COUPLERS
 - 2:90 WELD-ON FITTINGS - GALVANIZED STARTER COUPLERS
 - 2:91 WELD-ON FITTINGS - EPOXY STARTER COUPLERS
- 2:92 Z-PIPE
- 2:93 POTS

IMPORTANT NOTES:

Prices are subject to change without notice. Please call us at any time to verify current pricing. Regional Warehouse stocking of all products are subject to 1) manufacturer's policy, 2) regional customer need, and 3) price and availability. Please contact us to verify that specific products are in stock and available for sale in your area.

WIRELESS AGRICULTURAL IRRIGATION MONITORING

Features	PPAC	PPDC
No monthly / annual fees	•	•
Remote shutdown	•	•
Remote start	•	
WireRat technology	•	
Virtual shutdown timer	•	•
Available in CDMA	•	
Available in GSM		•
Mobile Applications	•	•
Notifications	PPAC	PPDC
Detects power ON / OFF at pump panel	•	
Is now running / has shut down		•
Has detected a wire cut	•	
Now pumping / Stopped pumping	•	



NETB13PPAC (PUMPPROXY® AC)

with WireRat® technology

Price Level	Order Qty	Price
0	< 8	
1	> = 8	
2	> = 16	
3	> = 24	

For single and three phase pumps with 120-240VAC control circuits. Remotely start and stop electrically powered pumps. Receive notifications of thermal overload and other types of power failure. Works in conjunction with HAND-OFF-AUTO switch.



NETB13PPDC (PUMPPROXY® DC)

Price Level	Order Qty	Price
0	< 8	
1	> = 8	
2	> = 16	
3	> = 24	

For engine driven pumps with 12VDC ignition circuits. Remotely monitor and shut down engine driven irrigation pumps with the NetIrrigate® PumpProxy®. Eliminate the need for expensive kill wires from a pivot panel to its associated irrigation wells.



INTRO
 1. ELECTRICAL
 2. PUMP ACC.
 3. HOSE, PE PIPE & ACC.
 4. IPS, PIP PIPE & ACC.
 5. SURFACE
 6. SPRINKLERS
 7. TRAVELER & WHEEL MOVE
 8. PIVOT
 9. TURF
 10. LOW VOLUME
 11. FILTERS
 12. INJECTION
 13. HARDWARE
 INDEX

FLOATING PUMPS

FLOATING PUMP PLATFORM

Part No.	Description	Price
FLOAT-4	4 Pontoon	
FLOAT-6	6 Pontoon	

COMPLETE FLOATING PUMP SYSTEMS PRICED UPON REQUEST

- Efficient - no suction lift
- No priming
- No suction lines
- Intake screen backflushes when pump is shut off
- No draining pump in winter
- Pump wastewater or fresh water
- Galvanized frame, intake strainer and weather cap are standard
- Winch tilts pump for service
- Remote or automatic starts are possible
- Water intake approximately 1' below surface
- Basic unit comes equipped with one pump mount, however two pump mounts are available upon request.



DOBBS FLOATING PUMPS

Part No.	HP	Price
CALL	CALL	CALL

Since 1960, Dobbs has served as a pioneer and industry leader in the manufacture of floating surface water pumps. Dobbs floating pumps are used daily in a wide range of applications which include farming operations, feedlots, dairies, golf courses, municipalities, quarries and mines, and sand and gravel operations to name a few. Pumps range in size from 5 horsepower – 75 horsepower and gallons per minute range from 200-2300. Each Dobbs Pump is individually assembled by hand; no assembly line production is used. Every pump is tested under actual load conditions. This ensures your Dobbs Floating Water Pump will meet and exceed your desired expectations. CALL US TODAY FOR A CUSTOMIZED QUOTE.

- No Costly Preparation
- Instant Water
- No Priming Necessary
- Follows Water Level
- Impeller & Screen at Top of Water
- Easy to Service



KID ELECTRIC FLOATING PUMPS

Part No.	HP	Price
CALL	CALL	CALL

Floating submersible or turbine pumps for a variety of applications include uses with Micro Rain or Ag series travelers, stationary or sprinkler cart applications, water transfer, and much more! Call us for help designing a float pump to fit your application. Pump capacity needed will determine price. CALL US TODAY FOR A CUSTOMIZED QUOTE.



SOLID STATE SOFT START

- OUTDOOR RATED
- 460V RATED WITH 120V CONTROL
- BUILT IN RUN CONTACTOR
- FULLY PROGRAMABLE FOR PUMP CONTROL

SOLID STATE SOFT START

Part No.	Description	HP	Price
VMX-H-55-CB4	460V Solid State Soft Start Type 3R with Disconnect	50	
VMX-H-68-CB4	460V Solid State Soft Start Type 3R with Disconnect	60	
VMX-H-96-CB4	460V Solid State Soft Start Type 3R with Disconnect	75	
VMX-H-125-CB4	460V Solid State Soft Start Type 3R with Disconnect	100	
VMX-H-220-CB4	460V Solid State Soft Start Type 3R with Disconnect	150	
VMX-H-248-CB4	460V Solid State Soft Start Type 3R with Disconnect	250	

Note: Additional sizes are available please call for more information.



EATON / CUTLER-HAMMER - PUMP PANELS

PUMP PANEL ACCEPTS BI-METALLIC OVERLOADS 480V

Part No.	Amperage Range	Nema Size	Max HP	Price
ECN5412CAC	9-45 AMP	SZ 1	10	
ECN5422CAE	9-45 AMP	SZ 2	25	
ECN5432CAG	20-100 AMP	SZ 3	50	
ECN5442CAJ	35-175 AMP	SZ 4	100	
ECN5452CAL	60-300 AMP	SZ 5	200	

PUMP PANEL SOLID STATE OVERLOAD 480V

Part No.	Amperage Range	Nema Size	Max HP	Price
ECN5412CAC-R63D	9-45 AMP	SZ 1	10	
ECN5422CAE-R63D	9-45 AMP	SZ 2	25	
ECN5432CAG-R63E	20-100 AMP	SZ 3	50	
ECN5442CAJ-R63F	35-175 AMP	SZ 4	100	
ECN5452CAL-R63G	60-300 AMP	SZ 5	200	



EATON / CUTLER-HAMMER - PUMP PANEL PARTS

SWITCHES

Part No.	Description	Price
10250T101	STARTER PUSH BUTTON BLACK	
10250T1311	SELECTOR SWITCH 2 POSITION	
10250T1323	SELECTOR SWITCH 3 POSITION	

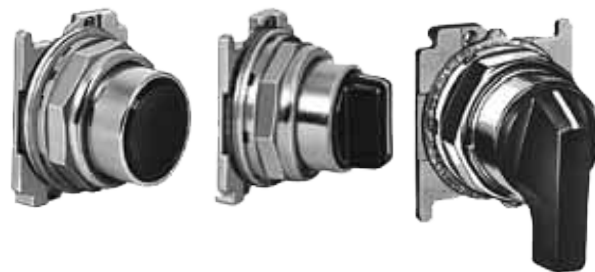

ACCESSORIES

Part No.	Description	Price
H2000 SERIES	HEATER PACKS FOR BI-METALLIC OVERLOAD, HP SPECIFIC	
10250T2	2 NO CONTACT BLOCK	
10250T53	1 NO CONTACT BLOCK	
10250TM51	HOA LEGEND PLATE	
10250T21KB-POP	KIT, 3 POS. SEL SW, 2 NO CONT BLOCK, HOA LEGEND PLATE	



MAGNETIC COIL

Part No.	Description	Price
9-2703-2	COIL, FRDM, SIZE 1-2, 240V	
9-2756-2	COIL, FRDM, SIZE 3, 240V	
9-1891-2	COIL, FRDM, SIZE 4-5, 240V	
9-2703-3	COIL, FRDM, SIZE 1-2, 480V	
9-2756-3	COIL, FRDM, SIZE 3, 480V	
9-1891-3	COIL, FRDM, SIZE 4-5, 480V	



INTRO
 1. ELECTRICAL
 2. PUMP Acc.
 3. HOSE, PE PIPE & Acc.
 4. IPS, PIP Pipe & Acc.
 5. SURFACE
 6. SPRINKLERS
 7. TRAVELER & WHEEL MOVE
 8. PIVOT
 9. TURF
 10. LOW VOLUME
 11. FILTERS
 12. INJECTION
 13. HARDWARE
 INDEX

SIEMENS PUMP CONTROL PANELS

Siemens Class 87 Heavy Duty Pump Control Panels are designed to withstand the most demanding environments. These rugged boxes are built utilizing a cold forming "tox" process. They are more rainproof, sleet and ice resistant than in the past. Typical applications include irrigation, agriculture, waste water treatment, petrochemical and other industries where motor control is challenged by harsh elements.

Installation is easy. Panels are factory wired to provide flexible control and to protect against short circuits and overloads. Ample space is provided for field modifications and installation of accessories. These pump control panels feature a full sized removable auxiliary panel for the mounting of accessories. The fusible version features fuse clips for full sized FLSR or compact sized J fuses and accessory mounting space for the most commonly used accessories.



Features and benefits:

- Siemens heavy duty NEMA starters offer prolonged service under severe duty conditions. NEMA rated, these starters utilize large silver cadmium oxide contacts and wide copper heat sinks to ensure rapid heat dissipation and maximum electrical life.
- ESP200 Solid-state overload relay has a 4:1 current adjustment range with a fine adjustment dial labeled in full load amps. The heaterless overload minimizes the heat trapped in the enclosures, thus reduces the cost for ventilation or cooling. It has an easily accessible reset button, provides visible and audible indications to ensure the tripped overload is ready to re-start. Additionally, it provides phase loss protection for the motor by tripping within 3 seconds upon complete loss of one phase in a three phase circuit.
- The motor circuit protector provides fast, accurate fault clearing that will minimize damage to the motor and control apparatus and protect branch circuit conductors.
- Rugged 30mm H-O-A switch and start pushbutton comes as standard features on each pump panel.
- The heavy duty fusible disconnect switch has visible blades for the highest level of safety; double break switching action to reduce arcing, increase lifetime and eliminate the "electric hinge"; oversized lugs; and a line side shield to help guard personnel from contact with live parts.
- The safety disconnect handle provides placement for up to three padlocks which can be used to lock the disconnect in the OFF position.
- Copper grounding lug for three #6 wires.
- Fully gasketed NEMA 3R rainproof enclosure to ensure a dust tight and water tight seal.
- Pre-punched opening with cover plate for convenient field installation of a conduit hub should top entry be required.
- Convenient mounting flanges at the top and bottom of the enclosure for easy mounting on poles or flat surfaces using keyhole slots.
- Removable door for ease of installation and maintenance.
- A wind catch is provided to prevent the door from slamming shut (or open) due to high wind.
- Heavy duty quarter turn latches are used for fast entry and proper sealing of the enclosure.
- Bold pilot legend on the front of the enclosure.
- UL listed for outdoor use and for service equipment - File #E185287

SIEMENS PUMP CONTROL PANELS - 460V FUSIBLE DISCONNECT

Part No.	NEMA Size	Max Horsepower	Amperage Range	Fuse Clip Amp / Volts	Price
87DUD6FC	Size 1	10 HP	5.5 - 22A	30A / 600V	
87EUE6FC	Size 1.75	15 HP	10 - 40A	30A / 600V	
87FUF6FC	Size 2	25 HP	13 - 52A	60A / 600V	
87GUG6FC	Size 2.5	30 HP	25 - 100A	60A / 600V	
87HUG6FC	Size 3	50 HP	25 - 100A	100A / 600V	
87IUH6FC	Size 3.5	75 HP	50 - 200A	200A / 600V	
87JUH6FC	Size 4	100 HP	50 - 200A	200A / 600V	
87LPU6FH	Size 5	200 HP	55 - 250A	400A / 600V	

Call for pricing over 200HP



SIEMENS PUMP PANEL PARTS

ESP200 SOLID STATE OVERLOAD RELAY

- Trip classes - 5, 10, 20, or 30 selectable by DIP-switches
- Phase loss protection - trips in less than 3 seconds
- Phase unbalance - trips based on trip class selected
- Ground fault - trips 60% of motor current
- Ambient insensitive
- FLA dial with wide adjustment - 4:1 ratio
- Self-protected in short circuit condition (when used with proper fuses or motor starter protector)
- Test button - tests electronics
- Thermal memory
- Conformally coated circuit board
- Operating temperatures: -25C - 65C
- Touch-safe terminals
- UL listed - CSA certified

Part No.	NEMA Panel Size	FLA Adj. Range	60 Hz. Voltage	Price
3UB81234DW2	Size 1	5.5 - 22 AMP	460V 3 Phase	
3UB81234EW2	Size 1.75	10 - 40 AMP	460V 3 Phase	
3UB81334FW2	Size 2	13 - 52 AMP	460V 3 Phase	
3UB81334GW2	Size 2.5 - 3	25 - 100 AMP	460V 3 Phase	
3UB81334HW2	Size 3.5 - 4	50 - 200 AMP	460V 3 Phase	
3RB2066-1GC2	Size 5	55 - 250 AMP	460V 3 Phase	



NEMA STARTER

Open Type & Standard Width Enclosure 440-480 Volts, 3 Phase, 3 Pole

Part No.	NEMA Panel Size	FLA Adj. Range	Max. HP @ 460V	Price
14DUD32AC	Size 1	5.5 - 22 AMP	10 HP	
14EUE32AC	Size 1.75	10 - 40 AMP	15 HP	
14FUF32AC	Size 2	13 - 52 AMP	25 HP	
14GUG32AC	Size 2.5	25 - 100 AMP	30 HP	
14HUG32AC	Size 3	25 - 100 AMP	50 HP	
14IUH32AC	Size 3.5	50 - 200 AMP	75 HP	
14JUH32AC	Size 4	50 - 200 AMP	100 HP	
14LPU32AH	Size 5	55 - 250 AMP	200 HP	



OPERATING COIL FOR NEMA STARTER

Part No.	NEMA Panel Size	Volts @ 60 Hz.	Price
75D73070C	Size 1 - 2.5	240 - 480	
75D73251C	Size 3 - 3.5	240 - 480	
75D70131C	Size 4	240 - 480	
3RT1965-5AR31	Size 5	440 - 480	



CONTACT KIT FOR NEMA STARTER

Part No.	NEMA Panel Size	Number of Poles in Kit *	Price
75DF14	Size 1	1	
75EF14	Size 1.75	1	
75FP14	Size 2	1	
75GP14	Size 2.5	1	
75HF14	Size 3	1	
75IF14	Size 3.5	1	
75JG14	Size 4	1	
3RT1966-6A	Size 5	3	



*Note: On 3 Phase Controls, all 3 Poles should be replaced - Order 3 Poles

SELECTOR SWITCH, PUSH BUTTON, CONTACT BLOCKS, & KITS

Part No.	Description	Price
52SA2CAB	Selector Switch, 3 Position, Short Lever, B Cam, White Lever Insert	
52SB2CAB	Selector Switch, 3 Position, Long Lever, B Cam, White Lever Insert	
52BJK	Contact Block, 1 Normally Open - 1 Normally Closed	
52SA2CABA1P	Selector Switch Kit, 3 Position, Short Lvr. Switch, & Contact Block	
52PX8AN	Push Button Operator with Flush Cap - All colors	
52BAK	Contact Block, 1 Normally Open	
52PA8A3KP	Push Button Kit, Assembled Operator with Contact Block	



INTRO
 1. ELECTRICAL
 2. PUMP Acc.
 3. HOSE, PE PIPE & Acc.
 4. IPS, PIP Pipe & Acc.
 5. SURFACE
 6. SPRINKLERS
 7. TRAVELER & WHEEL MOVE
 8. PIVOT
 9. TURF
 10. LOW VOLUME
 11. FILTERS
 12. INJECTION
 13. HARDWARE
 INDEX

PVC PIPE

PVC WELL CASING & DROP PIPE

Note: The information contained on this page is meant for general reference only. On occasion, our supplier may change due to price and availability issues. If it does, change will also occur particularly in respect to part number, pieces per lift and feet per lift. Please feel free to call us at any time to follow-up on this information including current availability.

PVC IPS 160 PSI SOLID WELL CASING - WHITE - BELLED END - 20 FT. HANGING LENGTH

Part No.	Nominal Pipe Size	Casing Outside Diameter	Casing Inside Diameter	Approximate Wall Thickness	Bell Outside Dimension	Bell Depth	Pieces Per Lift	Feet Per Lift
30655050020002	5"	5.563"	5.109"	0.214"	5.991"	7.0"	20	400
30655060020002	6"	6.625"	6.084"	0.255"	7.135"	7.0"	26	520
30655080020002	8"	8.625"	7.921"	0.332"	9.290"	7.0"	14	280
30655100020002	10"	10.750"	9.874"	0.413"	11.717"	7.5"	12	240

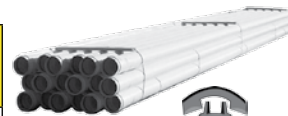

PVC IPS 160 PSI SLOTTED WELL CASING - WHITE - BELLED END - 20 FT. HANGING LENGTH

Part No.	Nominal Pipe Size	Casing Outside Diameter	Casing Inside Diameter	Approximate Wall Thickness	Slotted Opening Width	Row of Slots	ID Open Area Square Inches	
							Joint	Feet
30583050020002	5"	5.563"	5.109"	0.214"	.032"	4	215.00	10.75
30583060020002	6"	6.625"	6.084"	0.255"	.032"	4	215.00	10.75
30701080020002	8"	8.625"	7.921"	0.332"	.085"	6	930.20	46.51
30701100020002	10"	10.750"	9.874"	0.413"	.102"	6	930.20	46.51

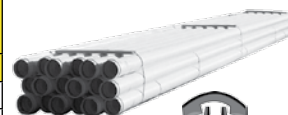

PVC IPS SCHEDULE 80 WHITE DROP PIPE - M X M THREADED END - 20 FT. LENGTH

Part No.	Nominal Pipe Size	Threaded PSI Rating @ 73°F	Average Outside Diameter	Approximate Inside Diameter	Approx. Wall Thickness	Approx. Wt. Per 100 Ft.	Pieces Per Lift	Feet Per Lift
30505010020003	1"	320	1.315"	9.36"	.179"	41.30	300	6000
30505012520003	1 1/4"	260	1.660"	1.255"	.191"	57.20	180	3600
30505015020003	1 1/2"	240	1.900"	1.476"	.200"	69.40	164	3280
30505020020003	2"	200	2.375"	1.913"	.218"	96.00	111	2220



COUPLINGS

DROP PIPE COUPLING - 304 STAINLESS STEEL

Part No.	Drop Pipe Size	Overall Length	Price
29DC14010	1"	2-1/2"	
29DC14012	1-1/4"	2-1/2"	
29DC14014	1-1/2"	2-1/2"	
29DC14020	2"	2-1/2"	



- Heavy-duty 304 stainless steel.
- Reamed and drifted for easy starting of threads.
- Tapered pipe threads for positive watertight connections.

PITLESS ADAPTERS

PITLESS ADAPTERS - BRONZE

Part No.	Drop Pipe Size	Nominal Well Casing	Casing Hole Opening	Max. Load Capacity Lbs.	Price
PT700	1"	5" through 12"	1-3/4"	5,000	
PT725	1-1/4"	5" through 12"	2-1/8"	5,000	
PT3000	2"	5-5/8" through 12"	3-1/8"	5,000	



- Cast from bronze to insure long life and durability in the most aggressive well conditions.
- Supports installations up to 5000 lbs.
- Extended casing nipple makes installation easy.
- Rubber inner and outer casing gaskets for certified and approved water tight seal from ground water contamination.
- Built-in lowering eyelet for easier installation.
- All PT Series pitless adapters are individually boxed.
- All PT Series adapters are certified and approved watertight to PAS-97 standards.

WELL CAPS

WELL CAPS - CAST ALUMINUM

Part No.	Casing O.D.	Nominal Well Casing Size	Conduit Connection	Vent Size	Price
AWTC5	5-9/16"	5"	1"	1"	
AWTC6	6-5/8"	6"	1-1/4"	1"	
AWTC8	8-5/8"	8"	1-1/4"	1"	

- Watertight, vermin - proof.
- Cast aluminum for strength and weather resistance.
- All stainless bolts and ground screws.
- Molded 3/16" gasket.



WELL SEALS

WELL SEALS - ABS

Single Hole Part No.	Fits Well Casing ID	Well Casing ID Size Range	Drop Pipe Size	Conduit Tap IPS	Vent Tap IPS	Price
PSWS5X1	5"	4-7/8" - 5-1/4"	1"	3/4"	1/2"	
PSWS5X11/4	5"	4-7/8" - 5-1/4"	1-1/4"	3/4"	1/2"	
PSWS5X11/2	5"	4-7/8" - 5-1/4"	1-1/2"	3/4"	1/2"	
PSWS5X2	5"	4-7/8" - 5-1/4"	2"	3/4"	1/2"	
PSWS6X1	6"	5-7/8" - 6-1/4"	1"	3/4"	1/2"	
PSWS6X11/4	6"	5-7/8" - 6-1/4"	1-1/4"	3/4"	1/2"	
PSWS6X11/2	6"	5-7/8" - 6-1/4"	1-1/2"	3/4"	1/2"	
PSWS6X2	6"	5-7/8" - 6-1/4"	2"	3/4"	1/2"	
PSWS8X1	8"	8" - 8-1/4"	1"	1"	1/2"	
PSWS8X11/4	8"	8" - 8-1/4"	1-1/4"	1"	1/2"	
PSWS8X2	8"	8" - 8-1/4"	2"	1"	1/2"	



- Well seals are molded from high impact ABS for extra strength
- Exclusive design of extra thick (1-1/4") PVC gland enables the sanitary sealing of a wide range of casing sizes
- Zinc plated steel bolts

WELL SEALS - CAST IRON

Part No.	Well Casing ID	Drop Pipe Size	Cable Hole Tapping	Vent Tapping	Price
Imported Single Drop Pipe, Split Top, for Submersible Pumps					
SWS5X1	5"	1"	1"	1/2"	
SWS5X11/4	5"	1-1/4"	1"	1/2"	
SWS5X2	5"	2"	3/4"	1/2"	
SWS6X1	6"	1"	1"	1/2"	
SWS6X11/4	6"	1-1/4"	1"	1/2"	
SWS6X11/2	6"	1-1/2"	1"	1/2"	
SWS6X2	6"	2"	1"	1/2"	
Domestic single drop pipe, split top, for submersible pumps					
196	8"	1"	1"	1/2"	
197	8"	1-1/4"	1"	1/2"	
198	8"	1-1/2"	1"	1/2"	
199	8"	2"	1"	1/2"	
040	8"	2-1/2"	1"	1/2"	
041	8"	3"	1"	1/2"	
042	8"	4"	1"	1/2"	

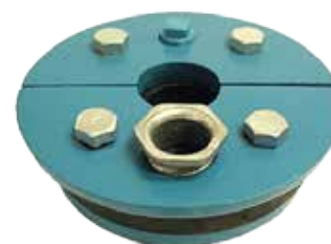

- Well seal for submersible & jet pumps
- Highest quality smooth gray-iron castings accurately machined to narrowest tolerances
- Finest heavy-duty 3/4" molded rubber packing gland assures seal regardless of minor imperfections in well casing
- Corrosion resistant, zinc plated steel bolts, and rugged construction provides for maximum torque
- Long lasting painted finish
- Complete with electrical conduit kit and plug for SWS series
- Individually cartoned

INTRO
 1. ELECTRICAL
 2. PUMP Acc.
 3. HOSE, PE PIPE & Acc.
 4. IPS, PIP Pipe & Acc.
 5. SURFACE
 6. SPRINKLERS
 7. TRAVELER & WHEEL MOVE
 8. PIVOT
 9. TURF
 10. LOW VOLUME
 11. FILTERS
 12. INJECTION
 13. HARDWARE
 INDEX

FLOMATIC SPRING CHECK VALVES

80E - ENVIRO-CHECK®

Part No.	Description	Price
4030E	3/4" FxF Brass Check Valve	
4031E	1" FxF Brass Check Valve	
4032E	1-1/4" FxF Brass Check Valve	
4033E	1-1/2" FxF Brass Check Valve	
4034E	2" FxF Brass Check Valve	



80AE - ENVIRO-CHECK®

Part No.	Description	Price
4040E	3/4" FxF Brass Check Valve 1/8" Tap	
4041E	1" FxF Brass Check Valve 1/8" Tap	
4042E	1-1/4" FxF Brass Check Valve 1/8" Tap	
4043E	1-1/2" FxF Brass Check Valve 1/8" Tap	
4044E	2" FxF Brass Check Valve 1/8" Tap	



80BE - ENVIRO-CHECK®

Part No.	Description	Price
4050E	3/4" FxF Brass Check Valve 1/8"x1/4" Tap	
4051E	1" FxF Brass Check Valve 1/8"x1/4" Tap	
4052E	1-1/4" FxF Brass Check Valve 1/8"x1/4" Tap	
4053E	1-1/2" FxF Brass Check Valve 1/8"x1/4" Tap	
4054E	2" FxF Brass Check Valve 1/8"x1/4" Tap	



80ME - ENVIRO-CHECK®

Part No.	Description	Price
4079E	2" MxF Brass Check Valve	



100ME - ENVIRO-CHECK®

Part No.	Description	Price
4221E	1-1/4" M x 1" F Brass Check Valve	
4242E	1-1/4" MxF Brass Check Valve	



80DI

Part No.	Description	Price
7937	2" FxF Ductile Iron Check Valve	
7936	2-1/2" FxF Ductile Iron Check Valve	
7938	3" FxF Ductile Iron Check Valve	
7939	4" FxF Ductile Iron Check Valve	
4088	5" FxF Ductile Iron Check Valve	
4089	6" FxF Ductile Iron Check Valve	



80MDI

Part No.	Description	Price
4084	2" MxF Ductile Iron Check Valve	
4083	3" MxF Ductile Iron Check Valve	
4077	4" MxF Ductile Iron Check Valve	
4075	5" MxF Ductile Iron Check Valve	
4081	6" MxF Ductile Iron Check Valve	



TANK CROSSES

SHORT CAST CROSSES

Part No.	Material	Overall Length	Tank Connection	Leg Connection	Drain Ports Size (Qty)	Top Ports Size (Qty)	Price
IC100G	Galvanized	3"	1"	1"	3/4" (1)	1/4" (2)	
IC125G	Galvanized	3-1/2"	1-1/4"	1-1/4"	3/4" (1)	1/4" (2)	
IC200G	Galvanized	3"	1"	1"	1/2" (2)	1/4" (2)	
IC225G	Galvanized	3-1/2"	1-1/4"	1-1/4"	3/4" (2)	1/4" (2)	
CICS100BSENL	Brass	4-1/2"	1" x 3/4"	1" x 3/4"	1/2" (2)	1/4" (2)	
CIC3125BSENL	Brass	4-1/2"	1-1/4" x 1"	1-1/4" x 1"	3/4" (2)	1/4" (2)	



LONG CAST CROSSES

Part No.	Material	Overall Length	Tank Connection	Leg Connection	Drain Ports Size (Qty)	Top Ports Size (Qty)	Price
CIC100BS14ENL	Brass	14"	1"	1" x 3/4"	1/2" (1)	1/4" (2)	
CIC125BS14ENL	Brass	14"	1-1/4"	1-1/4" x 1"	3/4" (1)	1/4" (2)	

INSTALLATION PACKAGES

TANK INSTALLATION PACKAGES

Part No.	Cross Included	Material	Length	Price
IP100BSENL	CICS100BSENL	Cast Brass	4-1/2"	
1" Brass Short Tank Cross 30/50 Pressure Switch Brass Nipple 0-100lb Steel Case Pressure Gauge 1/2" Relief Valve 1/2" No Kink Boiler Drain				



Part No.	Cross Included	Material	Length	Price
IP3125BSENL	CIC3125BSENL	Cast Brass	4-1/2"	
1-1/4" Brass Short Safety Tank Cross 30/50 Pressure Switch Brass Nipple 0-100lb Steel Case Pressure Gauge 3/4" Relief Valve 3/4" No Kink Boiler Drain				



Part No.	Cross Included	Material	Length	Price
IP100BS14ENL	CIC100BS14ENL	Cast Brass	14"	
1" Brass Long Safety Tank Cross 30/50 Pressure Switch Brass Nipple 0-100lb Steel Case Pressure Gauge 1/2" Relief Valve 1/2" No Kink Boiler Drain				



Part No.	Cross Included	Material	Length	Price
IP125BS14ENL	CIC100BS14ENL	Cast Bronze	14"	
1-1/4" Bronze Long Tank Cross 30/50 Pressure Switch Brass Nipple 0-100lb Steel Case Pressure Gauge 3/4" Relief Valve 3/4" No Kink Boiler Drain				



INTRO 1. ELECTRICAL 2. PUMP Acc. 3. HOSE, PE PIPE & Acc. 4. IPS, PIP Pipe & Acc. 5. SURFACE 6. SPRINKLERS 7. TRAVELER & WHEEL MOVE 8. PIVOT 9. TURN 10. LOW VOLUME 11. FILTERS 12. INJECTION 13. HARDWARE INDEX

PRESSURE SWITCHES

Imported Pressure Switch Features:

- Designed for the control of electrically driven water pumps
- Suitable for all types of pumps: jet, submersible, reciprocating, etc
- Diaphragm actuated
- 1/4" FPT connection
- Standard, manual cut-out and low pressure cut-off available
- Terminal and ground screws are combination slotted, phillips heads
- Captive cover thumb screw
- Black plastic NEMA 1 general purpose enclosure
- UL listed US and Canada
- Individually boxed - Bulk packaging available on standard switch only



IMPORTED PRESSURE SWITCHES

Part No.	Description	Cut in / Cut off	Price
PS2040	Standard Switch	20 PSI / 40 PSI	
PS3050	Standard Switch	30 PSI / 50 PSI	
PS4060	Standard Switch	40 PSI / 60 PSI	

Square D Pressure Switch Features:

- Designed for the control of electrically driven water pumps
- Diaphragm actuated
- Differential increases with range
- Contacts open on increased pressure
- General purpose enclosure NEMA Type 1
- Individually boxed - Bulk packaging available upon request
- 1/4" MPT connection



SQUARE D PRESSURE SWITCHES

Part No.	Description	Cut in / Cut off	Price
9013FSG920/40	Standard Switch	20 PSI / 40 PSI	
9013FSG930/50	Standard Switch	30 PSI / 50 PSI	
9013FSG940/60	Standard Switch	40 PSI / 60 PSI	

Note: Low Pressure Cutoff and Manual Cutoff Quoted by Special Request

PUMP START RELAYS

Pump Start Relay Contactors are UL and UL Canada rated. Industrial non-metallic gray enclosures are UL, CSA listed and rated NEMA 4X for indoor or outdoor use. Wide coil operating range. Pressure screw terminals accept 18 through 10 AWG wire. Mechanical life up to 10 million operations. Long electrical life. Watertight, dust tight and rain tight.

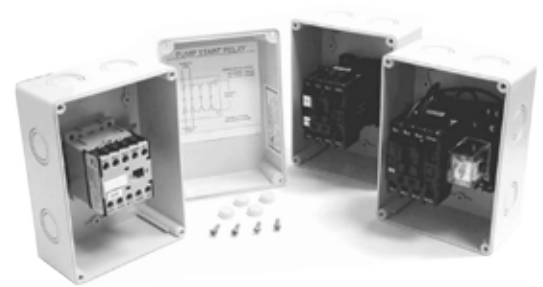

DIRECT CONTROL STYLE CONTACTOR

Part Number	Input-Pump Start Relay			Contactor Coil Voltage	Pump Motor HP (Max)				Price
	Volts VAC	Required Coil Power			Single Phase*		Three Phase**		
		Close	Hold		120 v	230 v	200/300 v	460 v	
PSR123-24	24	26 VA	4.2 VA	24	1 HP	2 HP	3 HP	5 HP	
PSR123-120	120	26 VA	4.2 VA	120	1 HP	2 HP	3 HP	5 HP	
PSR123-230	230	26 VA	4.2 VA	230	1 HP	2 HP	3 HP	5 HP	

1. Direct control style: The input volts must match the controller output voltage. The contactor coil voltage must match the controller voltage.
2. VA = Volt Amps. To determine the operating amperage needed by the coil, divide the VA by the controller output voltage.

*Single phase systems require motor overload protection within the motor.

** Three phase systems: May require motor overload protection within the motor. For proper overload protection consult the NEC (National Electric Code) and local building codes before installation.

MOTOR SAVERS - SYMCOM

SymCom - 777 Enhanced Overload Relays

All of the 777 model overload relays provide unsurpassed protection by combining overload, underload, voltage and power monitoring functions in one package. The 777s incorporates a 3-digit LED display that is used for programming, providing real-time operational information and displaying diagnostic codes to aid in troubleshooting a fault condition. The 777 Series can be used as stand-alone products or used in a network to communicate with a PC, PLC, SCADA system, or SymCom's Solutions Software with the help of its built-in RS-485 communications port. The 777s, in conjunction with SymCom's CIO modules, supports several communication protocols including Modbus/RTU, Modbus/TCR, DeviceNet and Profibus. The units can also be connected to SymCom's remote monitors for a simple, cost-effective way to meet new requirements for arc-flash safety. The unit's many features include enhanced trip classes beyond the NEMA standard trip classes. The settable trip class range is 2-60, with or without jam protection, and a secondary linear trip delay can be set with a range of 0-60 seconds. If both the trip class and linear trip delay are set, the 777s will follow the faster trip time. Another feature is the automatic dry-well recovery timer that allows the unit to automatically select a restart delay based on the last cycle's run time. This allows the 777s to optimize restart delay times. The 777s can be pre-programmed with a 9-volt battery prior to actual installation. This can save a lot of time during initial installations and avoid subsequent service calls when commissioning new projects. Common applications include conveyor systems, HVAC equipment, saws and grinders, fan motors and almost any pumping application, to save the cost and extra wiring associated with a CPT.

SymCom - 777-P2

SymCom's Model 777-P2 is a fully programmable electronic overload relay. It is designed to monitor and protect any 3-phase, 200-480VAC motor drawing 2-800 full load amps (external CTs are required above 90 amps). It provides unsurpassed protection from faulty voltage, underload and overload conditions.

SymCom - 777-HVR-P2

SymCom's Model 777-HVR-P2 has all the same features as the 777-P2 above, but this unit's Form C contacts are pilot duty rated at 470VA @ 600VAC for applications where a control power transformer (CPT) is not used on a 480V system.

SymCom - 455

The Model 455 three-phase voltage monitor combines load and line-side monitoring to alert the user of contact failure or impending contact failure. The line-side monitoring will protect the motor from damaging line-side conditions prior to the motor starting. With other line/load-side voltage monitors, the motor must be started before a voltage problem is detected. With the Model 455, your motor is fully protected at all times. The motor will not start if a power problem is present.

455s feature an adjustable trip delay (2-30 seconds), restart delay (manual, 2-300 seconds), and voltage unbalance trip point (2-8%). The status of the Model 455 can be easily identified by the four LEDs on the front of the device: Run, Undervoltage, Overvoltage, and Phasing Fault or by using the Informer-MS, which, in addition to present status, will display live voltages, last 20 faults, last 32 motor starts, and motor run hours

- The 455's universal range from 190-480VAC 50/60 Hz provides the versatility needed to handle global applications.
- Four adjustment pots provide versatility for a variety of applications.
- Both load and line-side monitoring provides contactor protection.
- Diagnostic LEDs indicate trip status and provide simple troubleshooting.
- Microcontroller-based circuitry provides better accuracy and higher reliability than analog designs.
- Single-phase conditions are detected regardless of regenerated voltages.
- Transient protection meets IEEE and IEC standards and permits operation under tough conditions.

SYMCOM MOTOR SAVERS

Part No.	Description	Price
777-HVR-P2	3 Phase Overload Relay 340-480V/ 2-800FLA/ 480V Relay/Plus	
777-P2	3 Phase Overload Relay 200-480V/2-800FLA/Plus	
455	3-Phase Line Load Volt Monitor / 190-480V / adj.VUB,TD,RD	
Informer-MS	Handheld Device for Wirelessly Reading 20 Fault History and Real Time Voltage From Model 455s	



777-P2 & 777-HVR-P2

- Protects 3-phase motors from:
 - High voltage
 - Low voltage
 - Voltage unbalance
 - Reverse-phase
 - Overcurrent
 - Undercurrent (dry running pumps)
 - Current unbalance
 - Single-phase
 - Ground fault, Class II
 - Network programmable
 - Programmable with 9-volt battery prior to installation
- Automatic reset with three separate restart delay timers, or manual reset
- Tamper guard
- RS-485 communications port (communications module sold separately)
- 3-digit LED diagnostic display
- Last fault memory
- UL and ULC listed
- CE compliant
- CSA approved
- Surface or DIN rail mount
- 5-year warranty
- Made in USA
- Cell RAM wireless monitoring of 777 available.



455 Features

Protects 3-Phase Motors from:

- Contact failure
- Loss of any phase (single-phasing) on the load or line side
- Low voltage
- High voltage
- Voltage unbalance
- Phase reversal
- Rapid cycling

Additional Features

- Manual, 2-300 second variable restart delay
- 2-8% variable voltage unbalance
- 2-30 second variable trip delay
- Surface mount
- Finger-safe terminals
- UL and cUL listed
- 5-year warranty
- Made in USA

INTRO
 1. ELECTRICAL
 2. PUMP Acc.
 3. HOSE, PE PIPE & Acc.
 4. IPS, PIP PIPE & Acc.
 5. SURFACE
 6. SPRINKLERS
 7. TRAVELER & WHEEL MOVE
 8. PIVOT
 9. TURF
 10. LOW VOLUME
 11. FILTERS
 12. INJECTION
 13. HARDWARE
 INDEX

CYCLE STOP VALVES

The Cycle Stop Valve is a patented pump control valve that makes a variable flow pump out of any standard, constant speed pump. Attached to the discharge of the pump, the Cycle Stop Valve (CSV) automatically chokes back the output of a pump to match the users requirement for water. As the gallons per minute decrease, the amperage draw decreases as well. The CSV maintains a constant pressure for the water user regardless of the amount of water being used. The CSV is completely mechanical, requiring no electronics. Large pumps are now capable of very small flows without expensive controls, huge pressure tanks, or water towers. Pumps equipped with a CSV can operate safely from as low as 1 gpm to as much as the pump can produce. The CSV stops pump cycling, eliminates water hammer, extends pump life, and reduces energy costs. The CSV can hold a steady level in elevated tanks and water towers or can deliver constant pressure to an entire city from a tank as small as 44 gallons. Cycle Stop Valves are available for flow rates of 1 to 5,000 GPM or more. When your need arises for whatever the pump application, whether it be for industrial, municipal, residential, large or small irrigation requirements, state of the art Cycle Stop pump control valves will provide the following benefits:

- Make your pump exactly match your flow while providing constant pressure
- Stop destructive on/off cycles every time you use water
- Reduce pressure tank size needed
- Eliminate water hammer, noise, and reduce pipeline breaks and leaks
- Easily replace complicated and expensive variable frequency drives (VFD)
- Conserve water and improve pressure
- Allow irrigation zones to match the system, not the pump, and improve coverage
- Eliminate the need for large hydro tanks or water towers
- Benefit from constant pressure pump control and extend pump life
- Can be used as a bypass while water towers are being serviced

Part No.	Size	Connection	Flow Range	Maximum Pump Shut-Off PSI	Price
THERMOPLASTIC CSV "1" MODEL					
CSV1	1"	Threaded	1 - 25 GPM	150 PSI	
CSV1.25	1-1/4"	Threaded	2 - 50 GPM	150 PSI	
CSV1 Valves are available in preset pressure settings of 30, 40, 50 or 60 PSI. Part Numbers are CSV130, CSV140, CSV150, CSV160					
BRONZE SEBILOY LOW LEAD / COMPOSITE CSV "1Z" MODEL					
CSV1Z	1" FPT or 1-1/4" MPT	Threaded	1 - 25 GPM	400 PSI	
CSV1Z is available with an adjustment range of 15 - 150 PSI					
BRONZE CSV "1W" IN THE WELL MODEL					
CSV1W	1" FPT or 1-1/4" MPT	Threaded	1 - 25 GPM	400 PSI	
CSV1W is available with an adjustment range of 40 - 120 PSI					
BRONZE CSV "2W" MODEL					
CSV2W1.25T-2575	1-1/4"	Threaded	5 - 50 GPM	300 PSI	
CSV2W1.25T-50120	1-1/4"	Threaded	5 - 50 GPM	300 PSI	
CSV2W available with a 25 - 75 PSI or 50 - 120 PSI adjustment ranges					
POLYESTER COATED CAST IRON CSV3 "B" MODEL					
CSV3B-2T	2"	Threaded	5 -150 GPM	225 PSI	
CSV3B-2F	2"	Flanged	5 -150 GPM	225 PSI	
CSV3B-3T	3"	Threaded	5 -300 GPM	225 PSI	
CSV3B-3F	3"	Flanged	5 -300 GPM	225 PSI	
CSV3B-4F	4"	Flanged	5 -500 GPM	225 PSI	
CSV3B-6F	6"	Flanged	5 -1200 GPM	225 PSI	
CSV3B-8F	8"	Flanged	5 - 2000 GPM	225 PSI	
CSV3B-10F	10"	Flanged	5 -2500 GPM	225 PSI	
CSV3B-12F	12"	Flanged	5 -5000 GPM	225 PSI	
2" - 25-175 PSI standard adjustment range, 3" and larger 15 - 150 PSI adjustment range					



CSV1
CSV1.25



CSV1Z



CSV1W



CSV2W1.25



CSV3B

BRASS RELIEF VALVES

- Heavy duty brass for shallow, deep well and submersible pumps
- Spring loaded and pre-set under pressure, not adjustable
- 1/2": 3/4" discharge also available
- Recommended for cold water system installations only

Part No.	Size	Material	Pressure Setting	Price
IRV50NL	1/2" x 1/2"	Brass	Set at 75 PSI	
IRV75NL	3/4" x 1/2"	Brass	Set at 75 PSI	
IRV50-100NL	1/2" x 1/2"	Brass	Set at 100 PSI	
IRV75-100NL	3/4" x 1/2"	Brass	Set at 100 PSI	



AIR VALVES

- Used for reciprocating and submersible pumps to admit air to system
- Used for charging applications and many other uses
- Available in long and short patterns

Part No.	Size	Material	Description	Price
SN18	1/8"	Brass	Short, Light Spring (Snifter)	
SN18LNL	1/8"	Brass	Long, Light Spring (Snifter)	
SN25	1/4"	Brass	Short, Heavy Spring (Air)	
SN25LNL	1/4"	Brass	Long, Light Spring (Snifter)	



AIR RELEASES

- Deep Well Air Release
- Maintains proper ratio of air to water in submersible water systems
- Deluxe deep well air release features ABS float and cast body which prevents galvanic action at pump tank tapping

Part No.	Size	Description	Price
1223	1-1/4"	Deep Well Air Release	
1231	1-1/4"	Deep Well Air Release	



BLEEDER ORIFICE / DRAIN VALVE

- Provides a fast bleed through its large opening
- Complete closure prevents loss of pumping volume
- 3/4" Available in Brass
- 1" Available in Rubber, PVC, Bronze, Stainless Steel

Part No.	Size	Material	Description	Price
PO75BNL	3/4"	Brass	Bleeder Orifice	
PO100	1"	Rubber	Bleeder Orifice	
4501P	1"	PVC	Auto-Drain	
4501	1"	Bronze	Auto-Drain	
4501SS	1"	Stainless Steel	Auto-Drain	



DRY PRESSURE GAUGE

- Dry - Not Liquid Filled
- Steel Case
- Glass Face
- Brass Mount

Part No.	Size	Description	Price
1300	2"	0 - 100 PSI, 1/4" MPT Lower Mount	



LIQUID FILLED PRESSURE GAUGE

2-1/2" FACE, STAINLESS STEEL

Part No.	PSI Range	Price
2141GXB15	0-15 PSI	
2141GXB30	0-30 PSI	
2141GXB60	0-60 PSI	
2141GXB100	0-100 PSI	
2141GXB160	0-160 PSI	
2141GXB300	0-300 PSI	

4" FACE, STAINLESS STEEL

Part No.	PSI Range	Price
4141GXB30	0-30 PSI	
4141GXB60	0-60 PSI	
4141GXB100	0-100 PSI	
4141GXB160	0-160 PSI	

2-1/2" FACE, BLACK ABS PLASTIC CASE

Part No.	PSI Range	Price
LFS220-30	0-30 PSI	
LFS220-60	0-60 PSI	
LFS220-100	0-100 PSI	
LFS220-160	0-160 PSI	

4" FACE, BLACK ABS PLASTIC CASE

Part No.	PSI Range	Price
LFS310-30	0-30 PSI	
LFS310-60	0-60 PSI	
LFS310-100	0-100 PSI	
LFS310-160	0-160 PSI	



PRESSURE GAUGE ACCESSORIES

ACCESSORIES

Part No.	Description	Price
PIT25	Pitot Tube	
A90917	Pitot Tube	
A90952	Silcock Adapter	
12070006	Lock on Gauge Chuck 1/4" FIPT	
13180129	Schrader Valve	
12070010	Pocket Pressure Gauge 0-50 PSI	
9438-002	Fem. Quick Connect 1/4" FIPT	
9498	Male Quick Connect 1/4" FIPT	



DELUXE TORQUE ARRESTOR

- Molded from PVC
- Two piece design installs quickly
- Field adjustable to hold pump centered in well
- Fits all well casings from 4" to 8" I.D.
- Torque Arrestor is securely fastened to 1" or 1-1/4" drop pipe w/ 2 Ideal all stainless steel clamps included

Part No.	Description	Color	Price
TA48	Bagged, with 2 Ideal all stainless steel clamps	Black	



SPIDER STYLE TORQUE ARRESTOR

- "Spider" style molded from rubber
- Installs at discharge cap of submersible pump
- Tabs are easily cut for field alteration
- 4" - 6" casing, 1" center hole

Part No.	Description	Color	Price
TA6100	6" x 1" Spider Style Torque Arrestor	Black	



CABLE GUARD

- Snap-in style
- Keeps power cable from abrading against well casing
- A minimum of three to five should be used; one at the pump, one no further than 15' above the pump, and one between 25' and 30' above the pump
- Adjustable - use in 4", 5" and 6" wells, available for 1" or 1-1/4" drop pipe
- Made of polyethylene and will float

Part No.	Description	Color	Price
MG6	With Hole, Fits 4" - 6" Casing, Polyethylene	White	

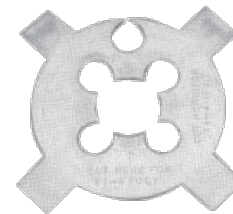

BRAIDED SUBMERSIBLE SAFETY ROPE

- Custom extruded from tough polypropylene fiber
- Highly resistant to chafing, abrasion & corrosion
- Recommended wherever minimum stretch and maximum strength are required
- Braided MR25 Series tested in excess of 1,000 lbs.
- Plastic reels

Part No.	Size x Length	Description	Price
MR25-500	1/4" x 500'	Braided Blue / White	
MR25-1	1/4" x 1,000'	Braided Blue / White	
MR25-3	1/4" x 3,000'	Braided Blue / White	



CAST BRONZE ROPE ADAPTERS AND EXTRA LONG MALE ADAPTERS

Part No.	Size	Description - INS x MIPT	Price
NLRBRA1	1" x 1"	Round Rope Adapter w/ Rope Eye	
NLRBRA1X114	1" x 1-1/4"	Round Rope Adapter w/ Rope Eye	
NLRBRA114	1-1/4" x 1-1/4"	Round Rope Adapter w/ Rope Eye	
NLXLRBMA1	1" x 1"	Hex Extra Long Male Adapter	
NLXLRBMA1X114	1" x 1-1/4"	Hex Extra Long Male Adapter	
NLXLRBMA11/4	1-1/4" x 1-1/4"	Hex Extra Long Male Adapter	
NLXLRBMA2	2" x 2"	Hex Extra Long Male Adapter	



INTRO
1. ELECTRICAL
2. PUMP Acc.
3. HOSE, PE PIPE & Acc.
4. IPS, PIP Pipe & Acc.
5. SURFACE
6. SPRINKLERS
7. TRAVELER & WHEEL MOVE
8. PIVOT
9. TURF
10. LOW VOLUME
11. FILTERS
12. INJECTION
13. HARDWARE
INDEX

SAND SEPARATORS

VERTICAL IN-LINE SAND SEPARATOR FEATURES:

- Removes 98% of 200 mesh or larger sand, grit and other solids heavier than water before entering expensive equipment
- Centrifugal action throws heavy particles out and downward into the collection chamber where they must be purged from the system
- Purified water is drawn to the separator vortex and up through the outlet
- Automatic purge valve can be added for maintenance free operation
- Flow range between 4 and 345 GPM for operating pressures up to 150 PSI
- Installs between pump and pressure tank
- No filter screens or cartridges to clean or replace
- Extends the life and operating cycles of water softeners, under sink RO systems, and water treatment cartridge systems
- Eliminates particulate build-up in hot water heaters, ice makers, toilet tanks, washing machine screens, faucet aerators and other water appliances



Part No.	GPM	Size	Length	Weight Lbs.	Price
R5V	4 - 10	1/2"	20"	13	
R7V	10 - 20	3/4"	20"	15	
R10V	18 - 38	1"	30-1/2"	26	
R12V	26 - 52	1-1/4"	30-1/2"	26	
R15V	38 - 79	1-1/2"	30-1/2"	26	
R20V	63 - 120	2"	36"	44	
R25V	100 - 180	2-1/2"	44"	55	
R30V	125 - 260	3"	48"	75	
R40V	190 - 345	4"	52"	120	

Note: Additional Sand Separators can be found in Filters Section 11

STANDARD FILTERS AND CARTRIDGES

STANDARD HOUSING FEATURES:

- Ideal for a wide range of residential, commercial and industrial applications
- 3/4" NPT inlet / outlet
- Available in 10" and 20" lengths
- Equipped with black mounting bracket cap
- #10 Filter available with either clear or opaque sump
- Maximum operating pressure 125 PSI @ 125° F
- Tested and certified by NSF International to NSF / ANSI Standard 42 for material and structural integrity requirements only

Part No.	Sump	Head	Inlet / Outlet	Length	Width	Price
150068	#10 Blue	Black	3/4" NPT	12-1/4"	5-1/8"	
150436	#10 Clear	Black	3/4" NPT	12-1/4"	5-1/8"	
150070	#20 Blue	Black	3/4" NPT	22-3/8"	5-1/8"	



STANDARD CARTRIDGE FEATURES: (2-1/2" DIA. X 9-3/4" LENGTH)

Polypropylene Cord Wound

- Economically priced
- Use for general purpose filtration
- Ideal for fine sediment reduction including sand, silt, scale & rust
- String wound design

Pleated Polyester

- Excellent for water well, institutional and light industrial applications
- 4 Sq. Ft. of Fabric in every cartridge
- Will not support bacteria growth
- Can be washed & reused several times

Part No.	Model	Medium	Construction	Micron	Mesh	GPM	Price
155187-52	CW-MF	Polypropylene	Cord Wound	30	420	5	
155214-52	CW-50	Polypropylene	Cord Wound	50	300	5	
155017-52	R30	Polyester	Pleated	30	420	12	
155038-52	R50	Polyester	Pleated	50	300	12	
155003	Cartridge Coupler used to connect 2 Cartridges for use in 20" filter						



BIG BLUE® / BIG CLEAR FILTERS AND CARTRIDGES

BIG BLUE® / BIG CLEAR: LARGE DIAMETER HOUSING FEATURES:

- Available in 10" and 20" lengths
- Large capacity housing designed for whole house and high-flow applications
- The high-flow cap is designed with a 1-1/4" internal port which allows for larger flow rates
- Equipped with black mounting bracket cap
- Caps are molded from polypropylene which is compatible with a broad range of chemicals
- Large capacity 4-1/2" diameter cartridges create a larger surface area for heavy-sediment applications
- Maximum operating pressure is 100 PSI for the 10" length and 90 PSI for the 20" length at 100°F

BIG BLUE® LARGE DIAMETER HOUSING FEATURES:

- Available with 3/4", 1" or 1-1/2" NPT inlet / outlet
- Housing and Cap are molded from polypropylene which is compatible with a broad range of chemicals

BIG CLEAR LARGE DIAMETER HOUSING FEATURES:

- Available 1" NPT inlet / outlet
- Housings are molded from Lexan (#10), Polycarbonate (#20)



Part No.	Sump	Head	Inlet / Outlet	Length	Width	Price
150469	#10 Blue	Black	3/4" NPT	13-1/8"	7-1/4"	
150467	#20 Blue	Black	3/4" NPT	23-3/8"	7-1/4"	
150238	#10 Blue	Black	1" NPT	13-1/8"	7-1/4"	
150234	#20 Blue	Black	1" NPT	23-3/8"	7-1/4"	
150240	#10 Blue	Black	1-1/2" NPT	13-5/8"	7-1/4"	
150236	#20 Blue	Black	1-1/2" NPT	23-3/8"	7-1/4"	
166219	#10 Clear	Blue	1" NPT	13-1/2"	7-1/8"	
166201	#20 Clear	Blue	1" NPT	23-3/4"	7-1/8"	

NOTE: The Big Clear Series of housings are not NSF component listed.

BIG BLUE® CARTRIDGE FEATURES: (4-1/2" DIA. X 10" LENGTH)

- Excellent for water well, institutional and light industrial applications
- 20 Square feet of media in every cartridge
- Pleated polyester fabric filter can be washed and reused several times. Reuse is not recommended in potable water applications
- Synthetic construction will not support bacteria growth
- Available with nominal 30 and 50 micron ratings

Part No.	Model	Medium	Construction	Micron	Mesh	GPM	Price
155101-51	R30-BB	Polyester	Pleated	30	420	25	
155053-51	R50-BB	Polyester	Pleated	50	300	25	
355221-43	WPX100BB97P	Filibraid	Wound	100	155	40	
SH144229	Cartridge Coupler used to connect 2 Cartridges for use in 20" filter						



PARTS AND ACCESSORIES FOR CARTRIDGE TYPE FILTERS

Part No.	Description	Price
150578	MC-1A Mounting Bracket Kit for 3/4" Standard Filters Includes Bracket and Screws	
150061	WB-SS Mounting Bracket Kit for Big Blue® Filters Includes Stainless Steel Bracket with Screws	
150295	SW-2 Spanner Wrench for 3/4" Standard Housing	
150296	SW-3 Spanner Wrench for 10" Big Blue® Housing	
SH144368	SW-4 Spanner Wrench for 20" Big Blue® Housing	
155003	Cartridge Coupler for Standard Cartridges	
SH144229	Cartridge Coupler for Big Blue® Cartridges	



Note: Additional Filters can be Located in Section 11

INTRO 1. ELECTRICAL 2. PUMP Acc. 3. HOSE, PE PIPE & Acc. 4. IPS, PIP Pipe & Acc. 5. SURFACE 6. SPRINKLERS 7. TRAVELER & WHEEL MOVE 8. PIVOT 9. TURF 10. LOW VOLUME 11. FILTERS 12. INJECTION 13. HARDWARE INDEX

PRIMING PUMPS



DP SERIES HAND DIAPHRAGM PRIMERS

Part No.	Description	Suction Pipe Size	Price
DP5	# 5 Hand Diaphragm Primer, Complete	2", 3", 4"	
DP7	# 7 Hand Diaphragm Primer, Complete	4", 5", 6"	
DP9	# 9 Hand Diaphragm Primer, Complete	6", 8" or Larger	
9-30	Hand Diaphragm Primer, Complete	4", 5", 6", 8"	

Note: Replacement parts also available.

EP SERIES EXHAUST PRIMERS

Primer Selection Chart					Part No.	Adapter Size	Price
EP60/90 Series					EP60/90/1	1" NPT Adapter	
Engine Displacement Cubic In.					EP60/90/1.25	1-1/4" NPT Adapter	
50	100	150			EP60/90/1.5	1-1/2" NPT Adapter	
Suggested RPM					EP60/90/2	2" NPT Adapter	
2500	2000	1800			EP60/90/2.5	2-1/2" NPT Adapter	
					EP60/90/3	3" NPT Adapter	
EP150/225 Series					EP150/225/1.25	1-1/4" NPT Adapter	
Engine Displacement Cubic In.					EP150/225/1.5	1-1/2" NPT Adapter	
150	200	250	300	400	EP150/225/2	2" NPT Adapter	
Suggested RPM					EP150/225/2.5	2-1/2" NPT Adapter	
2300	2000	1800	1700	1200	EP150/225/3	3" NPT Adapter	
					EP150/225/3.5	3-1/2" NPT Adapter	
					EP150/225/4	4" NPT Adapter	
EP250/300 Series					EP250/300/1.25	1-1/4" NPT Adapter	
Engine Displacement Cubic In.					EP250/300/1.5	1-1/2" NPT Adapter	
200	250	300	400	500	EP250/300/2	2" NPT Adapter	
Suggested RPM					EP250/300/2.5	2-1/2" NPT Adapter	
2300	2200	2000	1600	1200	EP250/300/3	3" NPT Adapter	
					EP250/300/3.5	3-1/2" NPT Adapter	
					EP250/300/4	4" NPT Adapter	
EP400/500 Series					EP350/500/1.25	1-1/4" NPT Adapter	
Engine Displacement Cubic In.					EP350/500/1.5	1-1/2" NPT Adapter	
400	500	600			EP350/500/2	2" NPT Adapter	
Suggested RPM					EP350/500/2.5	2-1/2" NPT Adapter	
1900	1700	1400			EP350/500/3	3" NPT Adapter	
					EP350/500/3.5	3-1/2" NPT Adapter	
					EP350/500/4	4" NPT Adapter	

Note: Exhaust Primers are not recommended for use on turbo engines.



The Exhaust Primer is an air ejector adapted to an engine-driven pump. An adapter is attached to the exhaust stack to which the ejector is attached, and a lever-operated "exhaust valve" is provided by which the engine exhaust gases are momentarily diverted through the ejector during the priming period. "Momentarily" means 10 seconds to 2 minutes depending on the suction lift and length and size of the suction line. It operates on low engine exhaust pressure. When the exhaust valve is closed, the gases are directed through the ejector nozzle and air is drawn from the pump through the ejector suction. All standard Protek Exhaust Primers are designed to operate at 12 to 14 PSI and thereby provide maximum lift and rapid priming.

HP SERIES HAND DIAPHRAGM PUMP

Part No.	Description	Inlet / Outlet Size	Price
HP700	Aluminum Diaphragm Pump	1-1/2"	
HP900	Aluminum Diaphragm Pump	2"	





MP SERIES - MANIFOLD PRIMER

Part No.	Description	Price
MP1000	Manifold Primer	



SPECIALTY DIAPHRAGM PUMPS & REPLACEMENT DIAPHRAGMS

Part No.	Description	Price
HP700G	Gas Diaphragm Pump	
HP700E	Electric Diaphragm Pump	
PP35AC	Power Primer 1/2HP Single PH AC	
PP35AC-3PH	Power Primer 1/2HP 3 PH AC	
PP35AC-1HP/460V	Power Primer 1HP 460V 3PH	
PP35DC	Power Primer 12V DC	
D0054	#5 Diaphragm	
D0058	#7 Diaphragm	
D0061	#9 Diaphragm	
H0707C	#700 Diaphragm	
H0707C-NEO	#700 Diaphragm, Neoprene	
H0907-HYP	#900 Diaphragm, Hypalon Flat Style	
H0907C-FR	#900 Diaphragm, Fabric Reinforced	

INTRO
1. ELECTRICAL
2. PUMP Acc.
3. HOSE, PE PIPE & Acc.
4. IPS, PIP Pipe & Acc.
5. SURFACE
6. SPRINKLERS
7. TRAVELER & WHEEL MOVE
8. PIVOT
9. TURF
10. LOW VOLUME
11. FILTERS
12. INJECTION
13. HARDWARE
INDEX

PRIMING PUMPS - continued

PUMP PARTS AND ACCESSORIES

Part No.	Description	Price
PR-D0001	Fulcrum Bracket (DP7) (DP9)	
PR-D0003	Lock Nut 1-1/2" (DP7) (DP9)	
PR-D0004	Valve, Check Disk	
PR-D0047	Handle Assy, (Handle, Grip, Brkt) for #5,7,9	
PR-D0050	Eye Bolt, Fulcrum (#5 #7)	
PR-D0051	Fulcrum Eye Bolt FOR #9 - Short	
PR-D0054	Diaphragm Only for DP5	
PR-D0055	Lower Housing (DP5)	
PR-D0056	Upper Housing (DP5)	
PR-D0057	Fulcrum Bracket (DP5) Old Style (#5)	
PR-D0058	Diaphragm Only for DP7	
PR-D0059	Obsolete, Use Part # PR-D0087	
PR-D0061	Diaphragm Only for DP9	
PR-D0062	Lower Housing (DP9)	
PR-D0063	Upper Housing (DP9)	
PR-D0001	Fulcrum Bracket, Old Style (#7)	
PR-D0087	7 Lower Housing	
PR-D0088	7 Upper Housing	
PR-D0093	Handle Bracket Only (DP5) (DP7) (DP9)	
PR-D0095	Handle W/Grip (for #5,7 & 9)	
PR-D0104	Mounting Bracket (DP7) (DP9)	
PR-D0107	Bracket, Mounting (#7 #9)	
PR-D0127	Connecting Rod #5, 7, 9 (Eye Bolt), W/ Nuts - Long	
PR-D0129	Fulcrum Link (DP7) (DP9)	
PR-D0300	Valve Bushing (DP5)	
PR-D0303	Diaphragm Plate (DP5)	
PR-D0339	5,7 Valve, Check Ball	

Part No.	Description	Price
PR-D0340	Drain Cock (DP5) (DP7) (DP9)	
PR-D0095	Square Handle Assy W/Grip (for Old #7)	
PR-D0347A	Clevis Pin Assembly (Clevis Pin + Hair Pin), Long (DP7) (DP9)	
PR-D05RK	Repair Kit For #5 Hand Primer	
PR-D09RK	Repair Kit for #9 Hand Primer	
PR-H0374	Connecting Rod	
PR-H0375	Rod End Bearing	
PR-H0380	Crank Disk	
PR-H0701	Pump Body #700	
PR-H0703	Retainer Ring	
PR-H0704	Fulcrum	
PR-H0705	Suction Flange for #700	
PR-H0706	Discharge Flange for #700	
PR-H0707	HP700 Diaphragm Assembly	
PR-H0707C	Diaphragm Only #700	
PR-H0709SS	Plate, Upper/Lower Stainless Steel (Replaces H0908)	
PR-H0710	Valve, Discharge (HP700 & 900 Series)	
PR-H0714	Valve, Suction (HP700 Series)	
PR-H0902	700/900 Fulcrum Pin	
PR-H0903	Retainer Ring	
PR-H0904	Fulcrum	
PR-H0905 NEW	Suction Flange for #900	
PR-H0906	Discharge Flange	
PR-H0907-FAB	HP900 Diaphragm Assy, W/ Bolts, Nuts, Plate, Fabric Reinforce	
PR-H0912	Handle W/ Grip for HP900 Pump	

OIL TANK & DRIPPERS

MAGNUM DRIP OIL SYSTEM

Part No.	Price
100M	
100A	
Magnum Tank Assy.	
Mount Complete	
Total Tank & Mount	

- Exclusive Center Draw Oil Feed
- Nearly Eliminates Contamination
- One Gallon Sediment Sump
- 11 Gallon Poly UV Resistant Tank
- Automatic Water Pressure Activated Valve (optional)
- Easy Hookup - Unit Comes Complete
- Standard Tri-pod Stand



OIL DRIPPER

Part No.	Price
135-ST	
DRIP90	



McCROMETER FLOW METER

McCrometer flow meters are an economical choice for dependable flow measurement. The measuring device of this flow meter is a propeller, which when positioned in the center of the flowstream, will rotate at a velocity proportional to the velocity of the fluid moving through the flow meter. This rotation is transmitted mechanically to a register, and the fluid's volumetric flow rate and accumulated volume is then displayed via an instantaneous flow indicator and totalizer. The register case is hermetically sealed with a hinged lens cover and locking clasp. All McCrometer products are thoroughly tested and inspected during manufacture and prior to shipping. These meters require a minimum 5 diameters of straight pipe upstream and a minimum of 1 diameter of straight pipe downstream of the flow meter. Also required is a full pipeline of water for an accurate measurement. Although most installations are horizontally oriented, McCrometer flow meters can be specially ordered for vertical installation if needed. When properly ordered and installed, accuracy is guaranteed to be within + or - 2% of the actual flow.

- The model MO300 bolt-on saddle flow meter is our most popular and economical flow meter. It features a stainless steel saddle which eliminates the fatigue-related breakage common to cast iron and aluminum saddles and provides unsurpassed corrosion protection.
- The model ML100 irrigation flow meter is designed to provide accurate flow measurements at moderate pressure ratings in an inexpensive package. This low cost flanged tube meter is also a very popular selection, where a flanged connection is preferred.
- The model MF100 flanged meter features heavier steel construction which may be more desirable at higher operating pressures.

MO SERIES - IPS OD SADDLE METER

Part No.	Size	Flow Range GPM	Standard Dial Face	Reduced Dial Face	Price
BOLT ON SADDLE METER					
MO304	4"	50 - 600	0 - 800	0 - 250	
MO306	6"	90 - 1200	0 - 1300	0 - 800	
MO308	8"	100 - 1500	0 - 2500	0 - 1300	
MO310	10"	125 - 1800	0 - 3000	0 - 2500	
MO312	12"	150 - 2500	0 - 4000	0 - 3000	
WITH OVER RUN BEARING					
MO304-OV	4"	50 - 600	0 - 800	0 - 250	
MO306-OV	6"	90 - 1200	0 - 1300	0 - 800	
MO308-OV	8"	100 - 1500	0 - 2500	0 - 1300	
MO310-OV	10"	125 - 1800	0 - 3000	0 - 2500	
MO312-OV	12"	150 - 2500	0 - 4000	0 - 3000	
REVERSE PROPELLER FOR SURFACE WATER					
MO304SW	4"	50 - 600	0 - 800	0 - 250	
MO306SW	6"	90 - 1200	0 - 1300	0 - 800	
MO308SW	8"	100 - 1500	0 - 2500	0 - 1300	
MO310SW	10"	125 - 1800	0 - 3000	0 - 2500	
MO312SW	12"	150 - 2500	0 - 4000	0 - 3000	

Note: Specify pipe ID, OD & wall thickness when ordering.

MD SERIES - PIP / OD SADDLE METER

Part No.	Size	Flow Range GPM	Price
BOLT ON SADDLE METER			
MD304	4"	50-600	
MD306	6"	90-1200	
MD308	8"	100-1500	
MD310	10"	125-1800	
MD312	12"	150-2500	

*Also available with spline or grooved ends.

7 Digit Register



MF SERIES - 150 PSI FLANGED METER

Part No.	Size	Flow Range GPM	Price
MF-102	2"	35-250	
MF-103	3"	35-250	
MF-104	4"	50-600	
MF-106	6"	90-1200	
MF-108	8"	100-1500	
MF-110	10"	125-1800	
MF-112	12"	150-2500	



ML SERIES - 75 PSI FLANGED METER

Part No.	Size	Flow Range GPM	Price
ML-106	6"	90-1200	
ML-108	8"	100-1500	
ML-110	10"	125-1800	
ML-112	12"	150-2500	
Over-run Bearing Option For All Models			

MT SERIES - THREADED END METER

Part No.	Size	Flow Range GPM	Price
MT102	2"	40-250	
MT103	3"	40-250	
MT104	4"	50-600	



OPTIONS

Part No.	Description	Price
CB100-00	Canopy Boot	
OT110	Over-Run Bearing Assembly	

NOTE: Purchase of canopy boot & over-run bearing extends warranty to 3 years.



HOLE COVER SADDLES

Model No.	Size (OD)	Price
JC280183	4"	
JC280189	4.5"	
JC280341	6"	
JC280347	6.63"	
JC280356	8"	
JC280365	8.63"	
JC280540	10"	
JC280533	10.75"	



Dial faces are available with either 1) gallons per minute indicator, totaling in your choice of gallons, acre feet or acre inches, 2) cubic feet per second indicator, totaling in acre feet, or 3) litres per second indicator totaling in cubic feet.

Call for Volume Pricing

McCROMETER VANES & FLOW TUBES

FS100 FLOW STRAIGHTENER

Part No.	OD	Wall Thickness	Price
FS106-1	6.625	0.08-0.199	
FS106-2	6.625	0.2-0.32	
FS106-3	6.0	0.08-0.156	
FS106-4	6.0	0.157-0.260	
FS108-1	8.625	0.08-0.209	
FS108-2	8.625	0.21-0.34	
FS108-3	8.0	0.08-0.161	
FS108-4	8.0	0.162-0.260	

The FS100 straightens flow so that accurate flow measurement can be achieved in limited space installations. The flow straightener features a fabricated stainless steel body which is easy to install and is an ideal accessory for the MO300 and MD300 series flow meters.



ALUMINUM WELD-IN VANES

Part No.	Size	Price
TV804-AW	4"	
TV806-AW	6"	
TV808-AW	8"	
TV810-AW	10"	

STEEL WELD-IN VANES

Part No.	Size	Price
TV804-SW	4"	
TV806-SW	6"	
TV808-SW	8"	
TV810-SW	10"	

BOLT-IN TRI VANES (SET OF 3)

Part No.	Size	Price
T0835-00-K	4"	
T0836-00-K	6"	
T0837-00-K	8"	
T0838-00-K	10"	
T0839-00-K	12"	



SLIP-IN VANE RINGS

Part No.	Size	Price
T0873-11	3"	
T0874-11	4"	
T0806-50	6"	
T0808-50	8"	
T0811-50	10"	



ALUMINUM FLOW TUBES WITH VANES		Without Weld Ring		With Weld Ring	
Size	Description	Part No.	Price	Part No.	Price
4"	Aluminum Flow Tubes	TA204-26RWRE4		TA204-26RWWR4	
6"	Aluminum Flow Tubes	TA206-26KRRE6		TA206-26KRWR6	
8"	Aluminum Flow Tubes	TA208-26KRRE6		TA208-26KRWR6	
8"	Aluminum Flow Tubes 66" long	TA208-66KRRE6		TA208-66KRWR6	
10"	Aluminum Flow Tubes	TA210-26KRRE6		TA210-26KRWR6	
12"	Aluminum Flow Tubes	TA212-26HARE6		TA212-26KRWR6	



OD STEEL FLOW TUBES WITH VANES		Plain End		Flanged	
Size	Description	Part No.	Price	Part No.	Price
4"	Steel Flow Tubes	TD104-26PEPE6		TD204-26FLFL6	
6"	Steel Flow Tubes	TD106-26PEPE6		TD206-26FLFL6	
8"	Steel Flow Tubes	TD108-26PEPE6		TD208-26FLFL6	
8"	Steel Flow Tubes 30" Long	TD108-30PEPE6		TD208-30FLFL6	
10"	Steel Flow Tubes	TD110-26PEPE6		TD210-26FLFL6	
12"	Steel Flow Tubes	TD112-26PEPE6		TD212-26FLFL6	



ID STEEL FLOW TUBES WITH VANES		Plain End		Flanged	
Size	Description	Part No.	Price	Part No.	Price
4"	Steel Flow Tubes	TO104-26PEPE6		TO204-26FLFL6	
6"	Steel Flow Tubes	TO106-26PEPE6		TO206-26FLFL6	
8"	Steel Flow Tubes	TO108-26PEPE6		TO208-26FLFL6	
10"	Steel Flow Tubes	TO110-26PEPE6		TO210-26FLFL6	



BANJO FLOW METER

- Displays overall total volume & batch total volume.
- Display reads 6 digits for rate, 8 for total, 1 decimal in tenths.
- Digital readout in Metric or English.
- Magnetic style meter w/ stainless steel electrodes.
- Self calibrating meter—measures water.
- Easy to change six (6) AA batteries.
- Accuracy is 99% from 14 to 670 GPM for 3".
- Accuracy is 99% from 6 to 300 GPM for 2".
- No moving parts to fail during use.
- Glass-reinforced polypropylene.
- Temperature range from 0° to 150°F.

2" FULL PORT FLOW METER

Part No.	Description	Price
MFM220	2" Full Port Flow Meter with Digital Readout	
M220CPG6	2" x 2" Full Port Flange x 6" long	
M220FPT	2" FP Flange x 2" Female Pipe Thread	
M200MPT	2" SP Flange x 2" Male Pipe Thread	
M220BRB	2" FP Flange x 2" Hose Barb	
FC220	220 Series Full Port Worm Screw Clamp	



3" FULL PORT FLOW METER

MFM300	3" Full Port Flow Meter with Digital Readout	
M300CPG7	3" x 3" Full Port Flange x 7" long	
M300FPT	3" Flange x 3" Female Pipe Thread	
M300MPT	3" Flange x 3" Male Pipe Thread	
M300BRB	3" Flange x 3" Hose Barb	
FC300	300 Series Worm Screw Clamp	



DATA INDUSTRIAL FLOW METER

The Data Industrial Flow Meter utilizes the IR-220B 2" Brass insertion flow sensor to measure the flow through the irrigation pipeline. The IR flow sensor features a six-bladed impeller design with a proprietary, non-magnetic sensing mechanism. As the water flow turns the impeller a low impedance square wave signal is transmitted with a frequency proportional to the flow rate. The sensor mounts in a 2" NPT pipe saddle or Threadolet® for installation in pipe sizes from 3" to over 40". Positioning nuts on the three threaded retaining rods allow the sensor to be accurately positioned to a standard insertion depth of 1-1/2" into the pipe. When this insertion depth is maintained & there is at least 10 upstream & 5 downstream diameters of straight uninterrupted flow, an accuracy of +/-1% of full scale can be obtained from flow velocities of .5 to 30 ft/second (+/- 4% of reading within calibration range). The sensor can be subjected to a maximum of 221 °F & 400psi. A signal from the flow sensor is sent to the series 1500 flow monitor which is an economical, full featured digital flow monitor. The monitor is nema 4X rated & has a menu driven program that is accessed over a two line x 8 character alphanumeric display that can be configured by the user to display flow rate & flow total separately or simultaneously. A 120 VAC to 12 VDC transformer is included.

DATA INDUSTRIAL FLOW METER COMPONENTS

Part No.	Description	Price
220BR0006-1211	IR-220B Brass Flow Sensor	
1500-001	1500 Series Flow Monitor	
A1026	Regulated 120VAC to 12VDC Power Transformer	



TEE TYPE PVC FLOW SENSORS

The flow sensors generate a frequency which is proportional to flow rate. An internal preamplifier allows the pulse signal to travel up to 2000 feet without further amplification. Power to operate the sensor is provided by the flow monitor. The impeller bearing assembly, shaft and O-rings are replaceable in the field. Badger Meter flow sensors feature a closed, six-bladed impeller design, using a proprietary, non-magnetic sensing technology. The forward-swept impeller shape provides higher, more constant torque than four-bladed impeller designs, and is less prone to fouling by water-borne debris. The forward-curved shape, coupled with the absence of magnetic drag, provides improved operation and repeatability, even at lower flow rates. As the liquid flow turns the impeller, a low impedance signal is transmitted with a frequency proportional to the flow rate. Sensors of similar type are interchangeable, so there is no need for recalibration after servicing or replacement.

BADGER® SERIES 228PV

Part No.	Description	Price
228PV3006-1211	3" Tee Type PVC Flow Sensors	
228PV4006-1211	4" Tee Type PVC Flow Sensors	



MULTI-JET WATER METERS

This is a bronzed case, top load cold water velocity-type meter. Water is evenly distributed by multiple jet nozzles & flows past an impeller in the measuring chamber, creating an impeller velocity directly proportional to the water flow rate. The meter's register integrates velocity into totalized flow. A reliable, direct magnetic drive provides linkage between the measurement element & the register. No intermediate gearing is required & no gearing is exposed to water. These units come with a standard direct read register, low flow leak indicator & a six wheel odometer type totalizer. The register is calibrated to measure in gallons. Maximum working pressure is 150 psi & the maximum working temperature is 120°F. These meters meet or exceed all sections of AWWA Standard C-708.

MULTI-JET WATER METERS

Part No.	Size	Low Flow GPM	Continuous Flow GPM	Normal Flow GPM	Price
B16-A31-A03-0101A-1	1"	3/4	30	3-50	
M22-A00-A03-0101A-1	1-1/2"	1-1/2	75	5-100	
M24-A00-A03-0101A-1	2"	2	120	8-160	



MULTI-JET METER COUPLINGS

903-1-CPL	1"	Price Per Each Coupling (2 Required)	
904-1.5-CPL	1-1/2"	Price Per Each Coupling (2 Required)	
905-2-CPL	2"	Price Per Each Coupling (2 Required)	

NETAFIM™ USA WATER METERS

Netafim USA Water Meters are among the most reliable water meters on the market. They are backed by a 3 year warranty, & every meter is tested & calibrated in the factory to provide + or - 2% accuracy. These meters are available for use in agricultural, landscape, nursery & industrial application. Most meters are manufactured with a cast iron body which is painted & baked with powder coated epoxy for resistance to corrosive conditions. Two different registers, standard & digital, are available on most models. Both types are hermetically sealed, operate in a dry compartment & are magnetically driven. They are guaranteed not to get moisture in them or fog. Standard registers come with pulse output, flow in gallons indicator & may be ordered to totalize in either gallons or acre feet. Digital registers display the rate of flow in gallons per minute (gpm), & may be ordered to totalize in either gallons or acre feet.

REGISTERS

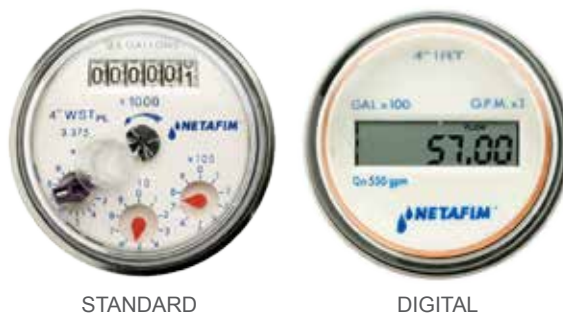

STANDARD

DIGITAL

"M" WATER METERS

Multi-Jet meters in sizes 3/4", 1" & 1-1/2" with meter coupling union / thread connection.

- Water meters using the multi-jet principle are the best cost vs performance, long life, flow measurement instruments. Wide clearances in the measuring chamber & negligible area of contact between static & moving parts are the main reasons for the high reliability of this design even in hard water.
- Only one moving part-the impeller-in contact with the water for minimum wear & utmost reliability.
- Magnetically driven sealed registers. Stainless steel / glass encapsulated is unconditionally guaranteed against fogging.
- Very accurate over a wide range of flows.

Installation: No upstream or downstream straight pipe is required. Must be mounted horizontally.

"M" WATER METERS

Part No.	Size	Register Head	Minimum Flow + or - 2%	Maximum Flow + or - 2%	Gallons / Pulse	Price
36M201T	3/4"	Standard	0.9 GPM	14 GPM	1.0	
36M201T-MPE		MPE Digital				
36M251T	1"	Standard	1.2 GPM	20 GPM	1.0	
36M251T-MPE		MPE Digital				
36M401.5T	1-1/2"	Standard	3.5 GPM	55 GPM	1.0	
36M401.5T-MPE		MPE Digital				



INTRODUCTION
 1. ELECTRICAL
 2. PUMP ACC.
 3. HOSE, PE PIPE & ACC.
 4. IPS, PIP PIPE & ACC.
 5. SURFACE
 6. SPRINKLERS
 7. TRAVELER & WHEEL MOVE
 8. PIVOT
 9. TURF
 10. LOW VOLUME
 11. FILTERS
 12. INJECTION
 13. HARDWARE
 INDEX

NETAFIM™ USA WATER METERS

"WMR" WATER METERS

WMR Meters: full impeller. Sizes 2" with metering coupling union / thread connection.

- Measures the full pipe flow.
- Magnetically driven sealed registers. Stainless steel / glass encapsulated is unconditionally guaranteed against fogging.
- Very accurate over a wide range of flows.

Installation Requirement: 10 diameters before the meter & 5 diameters after.

"WMR" WATER METERS

Part No.	Size	Register Head	Minimum Flow + or - 2%	Maximum Flow + or - 2%	Gallons / Pulse	Price
36WMR2T10	2"	Standard/Gallons	8.8 GPM	110 GPM	10	
36WMR2T10-AF		Acre Feet			32.6	
36WMR2T10-MPE		MPE Digital / Gallons			10	
36WMR2T10-MPE-AF		MPE Digital / Acre Feet			32.6	



"IRT" WATER METERS

IRT Meters: Sizes 3" to 10" with flanged connection.

- Paddle wheel meter specifically designed for irrigation application.
- Special design with open water passage allows measurement of water with high contents of impurities or debris & high resistance to fine sand damage.
- Negligible head loss
- Bearings are constantly flushed during operation to eliminate deposits of solids.
- Can be installed in any position (horizontal, vertical or inclined), but must always have a full flow of water to meter properly.

Installation Requirement: 10 diameters before the meter & 5 diameters after.

"IRT" WATER METERS

Part No.	Size	Register Head	Minimum Flow + or - 2%	Maximum Flow + or - 2%	Reed Switch Output Gallons / Pulse	Price
36IRT3F	3"	Standard/Gallons	45 GPM	500 GPM	10	
36IRT3F-AF		Acre Feet			32.6	
36IRT3F-R-D		Digital / Gallons			10	
36IRT3F-R-AF-D		Digital / Acre Feet			32.6	
36IRT4F	4"	Standard/Gallons	50 GPM	688 GPM	10	
36IRT4F-AF		Acre Feet			32.6	
36IRT4F-R-D		Digital / Gallons			10	
36IRT4F-R-AF-D		Digital / Acre Feet			32.6	
36IRT6F	6"	Standard/Gallons	65 GPM	1375 GPM	100	
36IRT6F-AF		Acre Feet			32.6	
36IRT6F-R-D		Digital / Gallons			100	
36IRT6F-R-AF-D		Digital / Acre Feet			32.6	
36IRT8F	8"	Standard/Gallons	130 GPM	2475 GPM	100	
36IRT8F-AF		Acre Feet			32.6	
36IRT8F-R-D		Digital / Gallons			100	
36IRT8F-R-AF-D		Digital / Acre Feet			32.6	
36IRT10F	10"	Standard/Gallons	300 GPM	4125 GPM	100	
36IRT10F-AF		Acre Feet			325.9	
36IRT10F-R-D		Digital / Gallons			100	
36IRT10F-R-AF-D		Digital / Acre Feet			325.9	



NETAFIM™ USA WATER METERS

"WST" WATER METERS

- WST, 3" - 8" has built-in straightening vanes & as such reduces the straight length of pipe required before & after the meter 5 diameters & 2 diameters respectively.
- Double magnetic transmission. This unique design enables the meter to handle a high load of sand since only the impeller is in contact with the water while the worm gears are located in a sealed, dry compartment which has no contact with the water.
- Repelling magnets enable accurate measurement across a wide range of flow rates including very low flows.
- Balanced impeller with equal load on the front & rear gears prevents wear of the bearings & maintains high accuracy of the meter even after long years of operation.
- Maximum working pressure is 230 PSI.
- The meter can be installed in any position, however for non-horizontal position the flow shall be upwards.
- The meter must have a full flow of water to operate properly.



"WST" FLOW METERS

Part No.	Size	Register Head	Minimum Flow + or - 2%	Maximum Flow + or - 2%	Output Gallons / Pulse	Price
36WST3F	3"	Standard/Gallons	4 GPM	660 GPM	10	
36WST3F-AF		Acre Feet			32.6	
36WST3F-MPE		MPE Digital / Gallons			10	
36WST3F-MPE-AF		MPE Digital / Acre Feet			32.6	
36WST4F	4"	Standard/Gallons	8 GPM	1266 GPM	10	
36WST4F-AF		Acre Feet			32.6	
36WST4F-MPE		MPE Digital / Gallons			10	
36WST4F-MPE-AF		MPE Digital / Acre Feet			32.6	
36WST6F	6"	Standard/Gallons	15 GPM	1431 GPM	100	
36WST6F-AF		Acre Feet			32.6	
36WST6F-MPE		MPE Digital / Gallons			100	
36WST6F-MPE-AF		MPE Digital / Acre Feet			32.6	
36WST8F	8"	Standard/Gallons	38 GPM	2475 GPM	100	
36WST8F-AF		Acre Feet			32.6	
36WST8F-MPE		MPE Digital / Gallons			100	
36WST8F-MPE-AF		MPE Digital / Acre Feet			32.6	

OCTAVE ULTRASONIC WATER METERS

- Double-beam ultrasonic sensors provide highly accurate flow data and reliable operation.
- No impeller or moving parts in the flow path provides for unrestricted, low pressure loss flows.
- Reduced maintenance of wear-prone parts commonly found in other meters.
- 2", 3", 4", 6", 8", 10" and 12" Meters are epoxy-coated and have cast iron flanged bodies.
- Flow ranges from >1GPM to 5,500GPM.
- Multi-line readout screen provides complete flow and volume information along with:
 - Leak detection
 - Output mode
 - Battery Level
 - Flow direction
 - Alarms and errors
 - Active communication mode
- Two "D" size Lithium batteries provide a 10 year life expectancy.
- Instantaneous flow rate in GPM / Ordered to totalize in either Gallons or Acre Feet.
- Working pressure: 175 PSI / Fluid temperature range: 32° to 122° F.
- Vacuum sealed and tamper proof IP68 register provides durability and long-term performance.
- Each meter ships with a certificate verifying flow accuracy with a +/- 1.5% accuracy.
- Standard registers are programmed to log and display both forward and reverse flow.
- Each meter has a unique, unalterable bar-coded serial number for identification.
- Octave is supplied with a unprecedented 5 year limited warranty – the industry's longest.



OCTAVE FLOW METERS

Part No.	Size	Register Head	Nominal Flow Range + or - 1.5%	Output Gallons / Pulse	Price
36OCT04GAL0.01	4"	Standard/Gallons	1.5 - 1,000	0.1	
36OCT04AF0.01		Acre Feet		0.1	
36OCT06GAL0.1	6"	Standard/Gallons	3 - 2,000	1.0	
36OCT06AF0.1		Acre Feet		1.0	
36OCT08GAL1.0	8"	Standard/Gallons	5 - 3,500	10	
36OCT08AF1.0		Acre Feet		10	
36OCT10GAL100	10"	Standard/Gallons	14 - 5,500	100	
36OCT10AF100		Acre Feet		100	

INTRO
1. ELECTRICAL
2. PUMP Acc.
3. HOSE, PE PIPE & Acc.
4. IPS, PIP Pipe & Acc.
5. SURFACE
6. SPRINKLERS
7. TRAVELER & WHEEL MOVE
8. PIVOT
9. TURF
10. LOW VOLUME
11. FILTERS
12. INJECTION
13. HARDWARE
INDEX

HEAT EXCHANGERS (COOLING COILS)



Regular, heavy duty and high capacity - three types of cooling coils to address your needs. The regular coil is designed for 75 hp capacity and has 16 ft. of 1-1/2" copper tubing. The heavy duty coil is designed for 125 hp and has 24 ft. of 1-1/2" copper tubing. The high capacity unit is designed for various horsepower capacity as indicated below. If you should need a high capacity unit, please specify size of inlet and outlet. Also, if you're using a turbocharged engine, please specify the addition of an innercooler for increased cooling of inlet air. Please Note: The heat exchanger warranty will be void if there is no bolted compression coupler or flange between the heat exchanger and the pump discharge.





REGULAR (75 HP)

Part No.	Size	Price
CCR4	4"	 Please Call for Pricing
CCR5	5"	
CCR6	6"	
CCR8	8"	
CCR10	10"	

HEAVY DUTY (125 HP)

Without Innercooler			With Innercooler		
Part No.	Size	Price	Part No.	Size	Price
CCH4	4"	 Please Call for Pricing	CCH4IN	4"	 Please Call for Pricing
CCH5	5"		CCH5IN	5"	
CCH6	6"		CCH6IN	6"	
CCH8	8"		CCH8IN	8"	
CCH10	10"		CCH10IN	10"	

HIGH CAPACITY

Without Innercooler			With Innercooler		
Part No.	HP	Price	Part No.	HP	Price
CCH150	150	 Please Call for Pricing	CCH150IN	150	 Please Call for Pricing
CCH225	225		CCH225IN	225	
CCH300	300		CCH300IN	300	
CCH350	350		CCH350IN	350	
CCH400	400		CCH400IN	400	
CCH450	450		CCH450IN	450	

PLEASE NOTE: COOLING COIL WARRANTY WILL BE VOID IF THERE IS NO BOLTED COMPRESSION COUPLER OR FLANGE BETWEEN THE COOLING COIL AND THE PUMP DISCHARGE.

AIR & VACUUM RELIEF VALVES - PLASTIC

JAIN® AIR & VACUUM RELIEF VALVE

Part No.	Model No.	Description	Price
12090033	VBK-3/4	3/4" Air / Vacuum Relief Valve	
12090023	VBK-1	1" Air / Vacuum Relief Valve	
12090028	VBKV-1	1" Air / Vacuum Relief Valve w/Shrader	



JAIN® AIR & VACUUM RELIEF VALVE

Part No.	Model No.	Description	Price
12090001	APV-1	1" Air / Vacuum Relief Valve	
12090004	APV-1-1/4	1-1/4" Air / Vacuum Relief Valve	
12090002	APV-1-1/2	1-1/2" Air / Vacuum Relief Valve	
12090007	APV-2	2" Air / Vacuum Relief Valve	
12090010	APVV-1	1" Air / Vacuum Relief Valve w/Shrader	
12090013	APVV-1-1/4	1-1/4" Air / Vacuum Relief Valve w/Shrader	
12090011	APVV-1-1/2	1-1/2" Air / Vacuum Relief Valve w/Shrader	
12090016	APVV-2	2" Air / Vacuum Relief Valve w/Shrader	



JAIN® CONTINUOUS AIR & VACUUM RELIEF VALVE

Part No.	Model No.	Description	Price
12090020	ARV-2	2" Continuous Acting Air Relief Valve	



NELSON CONTINUOUS AIR & VACUUM RELIEF VALVE

Part No.	Model No.	Description	Price
9672-003	ACV-200P	2" Continuous Acting Air / Vacuum Relief Valve	



INTRO
1. ELECTRICAL
2. PUMP Acc.
3. HOSE, PE PIPE & Acc.
4. IPS, PIP PIPE & Acc.
5. SURFACE
6. SPRINKLERS
7. TRAVELER & WHEEL MOVE
8. PIVOT
9. TURF
10. LOW VOLUME
11. FILTERS
12. INJECTION
13. HARDWARE
INDEX

AIR & VACUUM RELIEF VALVES - PLASTIC

NETAFIM GUARDIAN AIR & VACUUM RELIEF AIR VENTS

Part No.	Model No.	Description	Price
70561-002500	65ARIA075	3/4" Guardian Air / Vacuum Relief Valve	
70561-002600	65ARIA100	1" Guardian Air / Vacuum Relief Valve	
70561-004800	65ARIA100S	1" Guardian Air / Vacuum Relief Valve w/Shrader	
70561-002700	65ARIA2	2" Guardian Air / Vacuum Relief Valve	
70561-002800	65ARIA3	3" Guardian Air / Vacuum Relief Valve	



NETAFIM DYNAMIC AIR VENT (FOR 8" AND LARGER PIPELINES)

Part No.	Model No.	Description	Price
70561-001730	65AIRDY2	2" Dynamic Air Release Vent (Nylon body)	



NETAFIM AUTOMATIC CONTINUOUS ACTING AIR VENTS

Part No.	Model No.	Description	Price
70561-003700	65ARIS075	3/4" Continuous Acting Air Relief Valve	
70561-003900	65ARIS1	1" Continuous Acting Air Relief Valve	



NETAFIM AIR / VACUUM & CONTINUOUS ACTING AIR VENTS

Part No.	Model No.	Description	Price
70561-001105	65ARIB1-150	1" Combination Air Vent (Polypropylene body)	
70561-001100	65ARIB1	1" Continuous Acting Air / Vacuum Relief Valve	
70561-001700	65ARIB2PP	2" Continuous Acting Air / Vacuum Relief Valve	
70561-001725	65ARIB2PRO	Combination Air/ Vacuum and Continuous Acting Air Vent	



AIR & VACUUM RELIEF VALVES - ALUMINUM

API AIR VENT & VACUUM RELIEF VALVES

Part No.	Size	Description	Price
AV0200	2"	API Aluminum Air Vent	
AV0300	3"	API Aluminum Air Vent	



FRESNO AIR VENT & VACUUM RELIEF VALVES

Part No.	Size	Description	Price
F030-20003	2"	Fresno Air Vent & Vacuum Relief Valve	
F030-30003	3"	Fresno Air Vent & Vacuum Relief Valve	
F030-40003	4"	Fresno Air Vent & Vacuum Relief Valve	



AIR & VACUUM RELIEF VALVES - ALUMINUM

INFURSA AIR VENT & VACUUM RELIEF VALVES

Part No.	Size	Description	Price
VAIR2	2"	Infursa Air Vent & Vacuum Relief Valve	
VAIR3	3"	Infursa Air Vent & Vacuum Relief Valve	
VAIR4	4"	Infursa Air Vent & Vacuum Relief Valve	



TRAVIS AIR VENT & VACUUM RELIEF VALVES

Part No.	Size	Description	Price
AV150	1-1/2"	Travis Air Vent & Vacuum Relief Valve	
AV200	2"	Travis Air Vent & Vacuum Relief Valve	
AV300	3"	Travis Air Vent & Vacuum Relief Valve	



WATERMAN AIR VENT & VACUUM RELIEF VALVES

Part No.	Size	Description	Price
704800001	1-1/2"	Waterman Air Vent & Vacuum Relief Valve	
704801000	2"	Waterman Air Vent & Vacuum Relief Valve	
704802001	3"	Waterman Air Vent & Vacuum Relief Valve	
704804001	4"	Waterman Air Vent & Vacuum Relief Valve	



XCAD AIR VENT & VACUUM RELIEF VALVES

Part No.	Size	Description	Price
VRV2	2"	XCAD Air Vent & Vacuum Relief Valve	
VRV3	3"	XCAD Air Vent & Vacuum Relief Valve	
VRV4	4"	XCAD Air Vent & Vacuum Relief Valve	

CONTINUOUS ACTING AIR & VACUUM RELIEF VALVES - ALUMINUM

FRESNO CONTINUOUS ACTING AIR & VACUUM RELIEF VALVES

Part No.	Size	Description	Price
F035-20000	2"	Fresno Continuous Acting Air & Vacuum Relief Valve	
F035-30000	3"	Fresno Continuous Acting Air & Vacuum Relief Valve	
F035-40000	4"	Fresno Continuous Acting Air & Vacuum Relief Valve	



XCAD CONTINUOUS ACTING AIR & VACUUM RELIEF VALVES

Part No.	Size	Description	Price
AVCA2	2"	XCAD Continuous Acting Air & Vacuum Relief Valve	
AVCA3	3"	XCAD Continuous Acting Air & Vacuum Relief Valve	
AVCA4	4"	XCAD Continuous Acting Air & Vacuum Relief Valve	



INTRO
 1. ELECTRICAL
 2. PUMP Acc.
 3. HOSE, PE PIPE & Acc.
 4. IPS, PIP Pipe & Acc.
 5. SURFACE
 6. SPRINKLERS
 7. TRAVELER & WHEEL MOVE
 8. PIVOT
 9. TURF
 10. LOW VOLUME
 11. FILTERS
 12. INJECTION
 13. HARDWARE
 INDEX

PRESSURE RELIEF VALVES - SPRING LOADED TYPE

FRESNO PR-600A PRESSURE RELIEF VALVES

Part. No.	Size	Pressure Range	Description	Price
F031-22050A-XXX	2" FPT	0 - 70 PSI	Fresno PR-600A Pressure Relief	
F031-22052A-XXX	2" FPT	71 - 120 PSI	Fresno PR-600A Pressure Relief	
F031-27050A-XXX	2-1/2" FPT	0 - 70 PSI	Fresno PR-600A Pressure Relief	
F031-27052A-XXX	2-1/2" FPT	71 - 120 PSI	Fresno PR-600A Pressure Relief	
F031-32050A-XXX	3" FPT	0 - 60 PSI	Fresno PR-600A Pressure Relief	
F031-32052A-XXX	3" FPT	61 - 120 PSI	Fresno PR-600A Pressure Relief	
F031-42050A-XXX	4" FPT	0 - 50 PSI	Fresno PR-600A Pressure Relief	
F031-42052A-XXX	4" FPT	51 - 120 PSI	Fresno PR-600A Pressure Relief	

XXX - SPECIFY 22, 50, 80, 100, OR 125 PSI SETTING



FRESNO PR-900 PRESSURE RELIEF VALVES

Part. No.	Size	Pressure Range	Description	Price
F031-32010-XXX	3" FPT	0 - 50 PSI	Fresno PR-900 Pressure Relief w/Cover	
F031-32012-XXX	3" FPT	51 - 100 PSI	Fresno PR-900 Pressure Relief w/Cover	
F031-32013-XXX	3" FPT	101 - 150 PSI	Fresno PR-900 Pressure Relief w/Cover	
F031-42010-XXX	4" FPT	0 - 45 PSI	Fresno PR-900 Pressure Relief w/Cover	
F031-42012-XXX	4" FPT	46 - 130 PSI	Fresno PR-900 Pressure Relief w/Cover	
F031-42013-XXX	4" FPT	131 - 150 PSI	Fresno PR-900 Pressure Relief w/Cover	
F031-62010-XXX	6" FPT	0 - 50 PSI	Fresno PR-900 Pressure Relief w/Cover	
F031-62011-XXX	6" FPT	51 - 90 PSI	Fresno PR-900 Pressure Relief w/Cover	
F031-62012-XXX	6" FPT	91-120 PSI	Fresno PR-900 Pressure Relief w/Cover	

XXX - SPECIFY 22, 50, 80, 100, OR 125 PSI SETTING



PIERCE PRESSURE RELIEF VALVES

Part. No.	Size	Pressure Setting	Description	Price
P3221-50	3" FPT	50 PSI	Pierce Pressure Relief Valve	
P3221-80	3" FPT	80 PSI	Pierce Pressure Relief Valve	
P3221-100	3" FPT	100 PSI	Pierce Pressure Relief Valve	
P3221-120	3" FPT	120 PSI	Pierce Pressure Relief Valve	
P1730-50	3" MPT	50 PSI	Pierce Pressure Relief Valve	
P1730-80	3" MPT	80 PSI	Pierce Pressure Relief Valve	
P1730-100	3" MPT	100 PSI	Pierce Pressure Relief Valve	
P1730-120	3" MPT	120 PSI	Pierce Pressure Relief Valve	



TRAVIS PRESSURE RELIEF VALVE

Part. No.	Size	Pressure Range	Description	Price
SEP-4325-80	3" FPT	0 - 80 PSI	Travis Pressure Relief Valve	

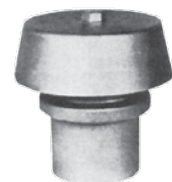

PRESSURE RELIEF VALVES

PRESSURE RELIEF VALVES - SPRING LOADED TYPE

WATERMAN PRESSURE RELIEF VALVES

Part. No.	Size	Pressure Range	Description	Price
706001001-XXX	2" FPT	11 - 65 PSI	Waterman AA-6B Pressure Relief	
706001002-XXX	2" FPT	66 - 120 PSI	Waterman AA-6B Pressure Relief	
706002001-XXX	2-1/2" FPT	11 - 65 PSI	Waterman AA-6B Pressure Relief	
706002002-XXX	2-1/2" FPT	66 - 120 PSI	Waterman AA-6B Pressure Relief	

Part. No.	Size	Pressure Range	Description	Price
706003041-XXX	3" FPT	11 - 40 PSI	Waterman AA-96B Pressure Relief	
706003101-XXX	3" FPT	41 - 100 PSI	Waterman AA-96B Pressure Relief	
706003121-XXX	3" FPT	101 - 150 PSI	Waterman AA-96B Pressure Relief	
706004021-XXX	4" FPT	11 - 34 PSI	Waterman AA-96B Pressure Relief	
706004041-XXX	4" FPT	35 - 60 PSI	Waterman AA-96B Pressure Relief	
706004101-XXX	4" FPT	61 - 105 PSI	Waterman AA-96B Pressure Relief	
706004121-XXX	4" FPT	106 - 150 PSI	Waterman AA-96B Pressure Relief	

Part. No.	Size	Pressure Range	Description	Price
706003042-XXX	3" FPT	11 - 40 PSI	Waterman AA-96C Pressure Relief w/Cover	
706003102-XXX	3" FPT	41 - 100 PSI	Waterman AA-96C Pressure Relief w/Cover	
706003122-XXX	3" FPT	101 - 150 PSI	Waterman AA-96C Pressure Relief w/Cover	
706004022-XXX	4" FPT	11 - 34 PSI	Waterman AA-96C Pressure Relief w/Cover	
706004042-XXX	4" FPT	35 - 60 PSI	Waterman AA-96C Pressure Relief w/Cover	
6004102-XXX	4" FPT	61 - 105 PSI	Waterman AA-96C Pressure Relief w/Cover	
706004122-XXX	4" FPT	106 - 150 PSI	Waterman AA-96C Pressure Relief w/Cover	

Part. No.	Size	Pressure Range	Description	Price
706206022-XXX	6" FPT	11 - 35 PSI	Waterman AA-9 Pressure Relief w/Cover	
706206080-XXX	6" FPT	36 - 80 PSI	Waterman AA-9 Pressure Relief w/Cover	
706206120-XXX	6" FPT	81 - 120 PSI	Waterman AA-9 Pressure Relief w/Cover	

XXX - SPECIFY 22, 50, 80, 100, OR 125 PSI SETTING

XCAD PRESSURE RELIEF VALVES

Part. No.	Size	Pressure Range	Description	Price
PRV2GA-XXX	2" FPT	0-25	XCAD Pressure Relief Valve Gray Spring	
PRV2YA-XXX	2" FPT	30-40	XCAD Pressure Relief Valve Yellow Spring	
PRV2BA-XXX	2" FPT	45-85	XCAD Pressure Relief Valve Black Spring	
PRV2YBA-XXX	2" FPT	85-150	XCAD Pressure Relief Valve Yel/Blu Spring	

Part. No.	Size	Pressure Range	Description	Price
PRV2.5GA-XXX	2.5" FPT	0-25	XCAD Pressure Relief Valve Gray Spring	
PRV2.5YA-XXX	2.5" FPT	30-40	XCAD Pressure Relief Valve Yellow Spring	
PRV2.5BA-XXX	2.5" FPT	45-85	XCAD Pressure Relief Valve Black Spring	
PRV2.5YBA-XXX	2.5" FPT	85-150	XCAD Pressure Relief Valve Yel/Blu Spring	

Part. No.	Size	Pressure Range	Description	Price
PRV3GA-XXX	3" FPT	0-25	XCAD Pressure Relief Valve Gray Spring	
PRV3YA-XXX	3" FPT	30-40	XCAD Pressure Relief Valve Yellow Spring	
PRV3BA-XXX	3" FPT	45-85	XCAD Pressure Relief Valve Black Spring	
PRV3YBA-XXX	3" FPT	85-150	XCAD Pressure Relief Valve Yel/Blu Spring	

Part. No.	Size	Pressure Range	Description	Price
PRV4GA-XXX	4" FPT	0-25	XCAD Pressure Relief Valve Gray Spring	
PRV4YA-XXX	4" FPT	30-40	XCAD Pressure Relief Valve Yellow Spring	
PRV4BA-XXX	4" FPT	45-85	XCAD Pressure Relief Valve Black Spring	
PRV4YBA-XXX	4" FPT	85-150	XCAD Pressure Relief Valve Yel/Blu Spring	

XCAD PRESSURE RELIEF VALVES ARE CIT TESTED

XXX - SPECIFY 22, 50, 80, 100, OR 125 PSI SETTING

PERFORMANCE OF INDIVIDUAL VALVES MAY VARY SLIGHTLY DUE TO SPRING VARIATIONS

85-150 PSI RATING TAKES TWO SPRINGS YELLOW AND BLUE



INTRO 1. ELECTRICAL 2. PUMP Acc. 3. HOSE, PE PIPE & Acc. 4. IPS, PIP PIPE & Acc. 5. SURFACE 6. SPRINKLERS 7. TRAVELER & WHEEL MOVE 8. PIVOT 9. TURF 10. LOW VOLUME 11. FILTERS 12. INJECTION 13. HARDWARE INDEX

MATCO BUTTERFLY VALVES

WAFER - DUCTILE DISC - LEVER

Size	Part No.	Price
2"	B5-RLO2	
2-1/2"	B5-RLO2.5	
3"	B5-RLO3	
4"	B5-RLO4	
5"	B5-RLO5	
6"	B5-RLO6	
8"	B5-RLO8	
10"	B5-RLO10	
12"	B5-RLO12	



WAFER - DUCTILE DISC - GEAR

Size	Part No.	Price
2-1/2"	B5-RWG2.5	
3"	B5-RWG3	
4"	B5-RWG4	
5"	B5-RWG5	
6"	B5-RWG6	
8"	B5-RWG8	
10"	B5-RWG10	
12"	B5-RWG12	
14"	B5-RWG14	



WAFER - STAINLESS DISC - LEVER

Size	Part No.	Price
2"	B5-RLO2S	
2-1/2"	B5-RLO2.5S	
3"	B5-RLO3S	
4"	B5-RLO4S	
5"	B5-RLO5S	
6"	B5-RLO6S	
8"	B5-RLO8S	
10"	B5-RLO10S	
12"	B5-RLO12S	



WAFER - STAINLESS DISC - GEAR

Size	Part No.	Price
3"	B5-RWG3S	
4"	B5-RWG4S	
5"	B5-RWG5S	
6"	B5-RWG6S	
8"	B5-RWG8S	
10"	B5-RWG10S	
12"	B5-RWG12S	
14"	B5-RWG14S	
16"	B5-RWG16S	



LUG - DUCTILE DISC - LEVER

Size	Part No.	Price
2"	B5-LGL2	
2-1/2"	B5-LGL2.5	
3"	B5-LGL3	
4"	B5-LGL4	
5"	B5-LGL5	
6"	B5-LGL6	
8"	B5-LGL8	
10"	B5-LGL10	
12"	B5-LGL12	



LUG - DUCTILE DISC - GEAR

Size	Part No.	Price
2"	B5-LGG2	
2-1/2"	B5-LGG2.5	
3"	B5-LGG3	
4"	B5-LGG4	
5"	B5-LGG5	
6"	B5-LGG6	
8"	B5-LGG8	
10"	B5-LGG10	
12"	B5-LGG12	



WAFER - DUCTILE DISC - LEVER

Size	Part No.	Price
2"	B6-RLO2	
2-1/2"	B6-RLO2.5	
3"	B6-RLO3	
4"	B6-RLO4	
5"	B6-RLO5	
6"	B6-RLO6	
8"	B6-RLO8	
10"	B6-RLO10	
12"	B6-RLO12	



WAFER - DUCTILE DISC - GEAR

Size	Part No.	Price
2-1/2"	B6-RWG2.5	
3"	B6-RWG3	
4"	B6-RWG4	
5"	B6-RWG5	
6"	B6-RWG6	
8"	B6-RWG8	
10"	B6-RWG10	
12"	B6-RWG12	



PVC LEVER

Size	Part No.	Price
2"	B1-RL02	
2-1/2"	B1-RL02.5	
3"	B1-RL03	
4"	B1-RL04	
6"	B1-RL06	



PVC GEAR

Size	Part No.	Price
8"	B1-RWG8	
10"	B1-RWG10	
12"	B1-RWG12	



BUTTERFLY VALVES

GRAYLINE 8500 SERIES BUTTERFLY VALVES

WAFER - STAINLESS DISC - LEVER

Size	Part No.	Price
2"	F085-020-05	
2-1/2"	F085-025-05	
3"	F085-030-05	
4"	F085-040-05	
5"	F085-050-05	
6"	F085-060-05	
8"	F085-080-05	
10"	F085-100-05	
12"	F085-120-05	



WAFER - STAINLESS DISC - GEAR

Size	Part No.	Price
2"	F085-020-10	
2-1/2"	F085-025-10	
3"	F085-030-10	
4"	F085-040-10	
5"	F085-050-10	
6"	F085-060-10	
8"	F085-080-10	
10"	F085-100-10	
12"	F085-120-10	
14"	F085-140-10	
16"	F085-160-10	

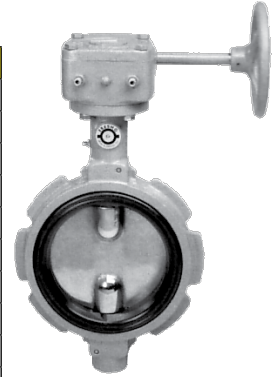

TUF-SKIN SERIES BUTTERFLY VALVES

WAFER - STAINLESS DISC - LEVER

Size	Part No.	Price
2"	B0200L	
2-1/2"	B0250L	
3"	B0300L	
4"	B0400L	
5"	B0500L	
6"	B0600L	
8"	B0800L	
10"	B1000L	
12"	B1200L	



WAFER - STAINLESS DISC - GEAR

Size	Part No.	Price
3"	B0300W	
4"	B0400W	
5"	B0500W	
6"	B0600W	
8"	B0800W	
10"	B1000W	
12"	B1200W	
14"	B1400W	
16"	B1600W	



SPEARS PVC BUTTERFLY VALVES

PVC - LEVER

Size	Part No.	Price
1-1/2"	682311-015	
2"	682311-020	
2-1/2"	682311-025	
3"	682311-030	
4"	682311-040	
6"	682311-060	
8"	682311-080	



PVC - GEAR

Size	Part No.	Price
1-1/2"	682321-015	
2"	682321-020	
2-1/2"	682321-025	
3"	682321-030	
4"	682321-040	
6"	682321-060	
8"	682321-080	
10"	682321-100	
12"	682321-120	



BUTTERFLY EXTENSIONS



MATCO EXTENSIONS

Valve Size	24"	Price	36"	Price	48"	Price	60"	Price	72"	Price
2" - 3"	B5-X24-A		B5-X36-A		B5-X48-A		B5-X60-A		B5-X72-A	
4"	B5-X24-B		B5-X36-B		B5-X48-B		B5-X60-B		B5-X72-B	
5" - 6"	B5-X24-C		B5-X36-C		B5-X48-C		B5-X60-C		B5-X72-C	
8"	B5-X24-D		B5-X36-D		B5-X48-D		B5-X60-D		B5-X72-D	
10"	B5-X24-E		B5-X36-E		B5-X48-E		B5-X60-E		B5-X72-E	
12"	B5-X24-F		B5-X36-F		B5-X48-F		B5-X60-F		B5-X72-F	
14"	B5-X24-G		B5-X36-G		B5-X48-G		B5-X60-G		B5-X72-G	
16"	B5-X24-H		B5-X36-H		B5-X48-H		B5-X60-H		B5-X72-H	

GRINNELL EXTENSIONS

Valve Size	24"	Price	36"	Price	48"	Price	72"	Price
3"	W-VEO300-24-E		W-VEO300-36-E		W-VEO300-48-E		W-VEO300-72-E	
4"	W-VEO400-24-E		W-VEO400-36-E		W-VEO400-48-E		W-VEO400-72-E	
6"	W-VEO600-24-E		W-VEO600-36-E		W-VEO600-48-E		W-VEO600-72-E	
8"	W-VEO800-24-E		W-VEO800-36-E		W-VEO800-48-E		W-VEO800-72-E	
10"	W-VEO1000-24-E		W-VEO1000-36-E		W-VEO1000-48-E		W-VEO1000-72-E	
12"	W-VEO1200-24-E		W-VEO1200-36-E		W-VEO1200-48-E		W-VEO1200-72-E	
14"	W-VEO1400-24-E		W-VEO1400-36-E		W-VEO1400-48-E		W-VEO1400-72-E	

FRESNO EXTENSIONS

Valve Size	24"	Price	36"	Price	48"	Price	60"	Price	72"	Price
2" - 6"	F084-E020-024		F084-E020-036		F084-E020-048		F084-E020-060		F084-E020-072	
8" - 12"	F084-E080-024		F084-E080-036		F084-E080-048		F084-E080-060		F084-E080-072	
14" - 16"	F084-E140-024		F084-E140-036		F084-E140-048		F084-E140-060		F084-E140-072	

TUF-SKIN EXTENSIONS

Valve Size	24"	Price	36"	Price	48"	Price	60"	Price	72"	Price
2" - 5"	VSE024		VSE036		VSE048		VSE060		VSE072	
6" - 12"	VSE124		VSE136		VSE148		VSE160		VSE172	
14"	-		VSE236		VSE248		VSE260		VSE272	
16"	-		VSE336		VSE348		VSE360		VSE372	

NOTE: Designate valve size and operator type when ordering.
Bushings, keys and hardware will be included.

BUTTERFLY VALVE ACCESSORIES

BUTTERFLY VALVE ACCESSORIES

LEVERS, GEAR BOXES, ELECTRIC ACTUATORS

Valve Size	Valve Brand	Lever Handle w / Lock Plate	Price	Gear Box w / Hand Wheel	Price	Electric Actuator	Price
2" - 3"	Matco	B5L3-LP		B5G23		P1-120N4	
	Grinnell	350812020801026		221819020801000		E006	
	Grayline	F085-020-62-LP		F085-020-70-HW		F085-ACT-1000-A	
4"	Matco	B5L4-LP		B5G4		P1-120N4	
	Grinnell	350812040401026		221819020801000		E006	
	Grayline	F085-040-62-LP		F085-020-70-HW		F085-ACT-1000-A	
5"	Matco	B5L6-LP		B5G56		P2-120N4	
	Grinnell	350812050801026		221819020801000		E013	
	Grayline	F085-050-62-LP		F085-020-70-HW		F085-ACT-1000-A	
6"	Matco	B5L6-LP		B5G56		P2-120N4	
	Grinnell	350812060801026		221819020801000		E013	
	Grayline	F085-060-62-LP		F085-020-70-HW		F085-ACT-1000-A	
8"	Matco	B5L8-LP		B5G8		P3-120N4	
	Grinnell	350812080801026		221819080801000		E025	
	Grayline	F085-080-62-LP		F085-080-70-HW		F085-ACT-1500-A	
10"	Matco	B5L10-LP		B5G10		P4-120N4	
	Grinnell	350812080801026		221819080801000		E051	
	Grayline	F085-080-62-LP		F085-080-70-HW		F085-ACT-3000-A	
12"	Matco	B5L12-LP		B5G12		P4-120N4	
	Grinnell	350812080801026		221819120801000		E091	
	Grayline	F085-080-62-LP		F085-080-70-HW		-	
14"	Matco	-	-	B5G14		P4-120N4.5	
	Grinnell	-	-	221819140601000		E171	
	Grayline	-	-	F085-140-70-HW		-	
16"	Matco	-	-	B5G16		P4-120N4.5	
	Grinnell	-	-	221819140601000		E171	
	Grayline	-	-	F085-140-70-HW		-	



NOTE: Grayline actuator part numbers and price are for 110 volt single phase. Grayline actuators based on 50PSI working pressure. Please advise if actual operating pressure exceeds 50PSI. Grinnell actuators are universal voltage covering a range from 24 to 240 volts AC or DC, 1 phase 50/100 HZ.

ELECTRIC ACTUATORS FOR BUTTERFLY VALVES

Remote Control RCEL Series Electric Actuators are engineered and equipped with a robust worm gear drive train and manual override to provide efficient, high performance automation for B5 Series MATCO NORCA and 8500 Series FRESNO butterfly valves. Valve sizes can range from 4" to 12".

	Size	Actuator Part No.	Drive Bushing	Mounting Kit	Price
MATCO	4"	RCEL-006-ALS-A120	RCEL6/9-Machining-4" Matco/Fresno	Mounts directly to valve	
	6"	RCEL-009-ALS-A120	RCEL6/9-Machining-6" Matco	Mounts directly to valve	
	8"	RCEL-015-ALS-A120	RCEL15/19-Mach.-6" FRS/8" MAT	VA51939	
	10"	RCEL-028-ALS-A120	RCEL28/50-Mach.-8" _10" FRS/10" _12" MAT	VA51940	
	12"	RCEL-050-ALS-A120	RCEL28/50-Mach.-8" _10" FRS/10" _12" MAT	VA51940	
FRESNO	4"	RCEL-006-ALS-A120	RCEL6/9-Machining-4" Matco/Fresno	VA51937	
	6"	RCEL-009-ALS-A120	RCEL15/19-Mach.-6" FRS/8" MAT	VA51938	
	8"	RCEL-028-ALS-A120	RCEL28/50-Mach.-8" _10" FRS/10" _12" MAT	Mounts directly to valve	
	10"	RCEL-050-ALS-A120	RCEL28/50-Mach.-8" _10" FRS/10" _12" MAT	Mounts directly to valve	
	12"	RCEL-060-ALS-A120	RCEL60/100-Machining-12" Fresno	Mounts directly to valve	



Butterfly Valves Not Included

NUT & BOLT SETS FOR BUTTERFLY VALVES

NUT AND BOLT SET

Size	Steel x BFV x Steel		PVC x BFV x PVC		Steel x BFV x PVC		CF x BFV x CF	
	Part No.	Price	Part No.	Price	Part No.	Price	Part No.	Price
2" - 4"	NBS5/8X4		NBS5/8X5		NBS5/8X5		NBS5/8X5	
5" - 6"	NBS3/4X4.5		NBS3/4X6		NBS3/4X5		NBS3/4X5	
8"	NBS3/4X4.5		NBS3/4X6.5		NBS3/4X6		NBS3/4X6	
10" - 12"	NBS7/8X5		NBS7/8X7.5		NBS7/8X7.5		NBS7/8X7.5	
14"	NBSSS14		NBSP14		NBSSP14		NBSSP14	
16"	NBSSS16		NBSP16		NBSSP16		NBSSP16	

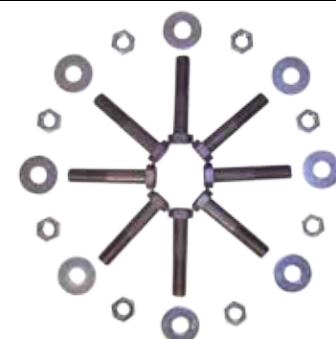

Please call for nut & bolt size recommendations for lug style butterfly valves & flange combinations.

INTRO
 1. ELECTRICAL
 2. PUMP Acc.
 3. HOSE, PE PIPE & Acc.
 4. IPS, PIP PIPE & Acc.
 5. SURFACE
 6. SPRINKLERS
 7. TRAVELER & WHEEL MOVE
 8. PIVOT
 9. TURF
 10. LOW VOLUME
 11. FILTERS
 12. INJECTION
 13. HARDWARE
 INDEX

FLANGES

CARBON STEEL FLANGES

CARBON STEEL 1/2" PLATE FLANGES

Size	OD Pipe Size		IPS Pipe Size		Blind	
	Part No.	Price	Part No.	Price	Part No.	Price
2"	CPFH0200-16		CPF0200		CPFBH0200	
2-1/2"	CPFH0250-16		CPF0250		CPFBH0250	
3"	CPFH0300-16		CPFH0300		CPFBH0300	
4"	CPFH0400-16		CPFH0400		CPFBH0400	
5"	CPFH0500-16		CPFH0500		CPFBH0500	
6"	CPFH0600-16		CPFH0600		CPFBH0600	
8"	CPFH0800-16		CPFH0800		CPFBH0800	
10"	CPFH1000-16		CPFH1000		CPFBH1000	
12"	CPFH1200-16		CPFH1200		CPFBH1200	
14"	CPFH1400		-		CPFBH1400	
16"	CPFH1600		-		CPFBH1600	



STAINLESS STEEL FLANGES

THREADED FLANGE

Size	Type 304 Threaded		Type 316 Threaded	
	Part No.	Price	Part No.	Price
2"	S1014TH020N		S1016TH020N	
2-1/2"	S1014TH024N		S1016TH024N	
3"	S1014TH030N		S1016TH030N	
4"	S1014TH040N		S1016TH040N	
5"	S1014TH050N		S1016TH050N	
6"	S1014TH060N		S1016TH060N	



SLIP-ON IPS 1/2" PLATE FLANGE

Size	Type 304		Type 316	
	Part No.	Price	Part No.	Price
2"	S1414SOP020		S1416SOP020	
2-1/2"	S1414SOP024		S1416SOP024	
3"	S1414SOP030		S1416SOP030	
4"	S1414SOP040		S1416SOP040	
5"	S1414SOP050		S1416SOP050	
6"	S1414SOP060		S1416SOP060	
8"	S1414SOP080		S1416SOP080	



SLIP-ON OD 1/2" PLATE FLANGE

Size	Type 304		Type 316	
	Part No.	Price	Part No.	Price
2"	S1414SOTP020		S1416SOTP020	
2-1/2"	S1414SOTP024		S1416SOTP024	
3"	S1414SOTP030		S1416SOTP030	
4"	S1414SOTP040		S1416SOTP030	
5"	S1414SOTP050		S1416SOTP050	
6"	S1414SOTP060		S1416SOTP060	
8"	S1414SOTP080		S1416SOTP080	



BLIND FLANGE

Size	Type 304 / 304L		Type 316 / 316L	
	Part No.	Price	Part No.	Price
2"	S1014BL020N		S1016BL020N	
2-1/2"	S1014BL024N		S1016BL024N	
3"	S1014BL030N		S1016BL030N	
4"	S1014BL040N		S1016BL040N	
5"	S1014BL050N		S1016BL050N	
6"	S1014BL060N		S1016BL060N	
8"	S1014BL080N		S1016BL080N	



CAST IRON FLANGES

CAST IRON THREADED COMPANION FLANGE

Size	Galvanized	Price	Black	Price
2"	CICFG08		CICFB08	
2-1/2"	CICFG09		CICFB09	
3"	CICFG10		CICFB10	
4"	CICFG11		CICFB11	
5"	CICFG12		CICFB12	
6"	CICFG13		CICFB13	
8"	CICFG14		CICFB14	



PVC FLANGES

PVC VAN STONE STYLE FLANGE

Size	IPS Pipe Size		Size	PIP Pipe Size	
	Part No.	Price		Part No.	Price
2"	854-020		-	-	
2-1/2"	854-025		-	-	
3"	854-030		6"	354-060F	
4"	854-040		8"	354-080F	
5"	854-050		10"	354-100F	
6"	854-060		12"	354-120F	
8"	854-080		14"	354-150F	
10"	854-100		16"	354-151F	
12"	854-120		18"	354-181F	
14"	854-140		20"	354-201F	
16"	854-160		24"	354-241F	



FLANGE GASKETS

FULL FACED RED RUBBER FLANGE GASKET

Size	1/16" Thick		Size	1/8" Thick	
	Part No.	Price		Part No.	Price
2"	FG1/16-02		2"	FG1/8-02	
2-1/2"	FG1/16-025		2-1/2"	FG1/8-025	
3"	FG1/16-03		3"	FG1/8-03	
4"	FG1/16-04		4"	FG1/8-04	
5"	FG1/16-05		5"	FG1/8-05	
6"	FG1/16-06		6"	FG1/8-06	
8"	FG1/16-08		8"	FG1/8-08	
10"	FG1/16-10		10"	FG1/8-10	
12"	FG1/16-12		12"	FG1/8-12	
14"	FG1/16-14		14"	FG1/8-14	
16"	FG1/16-16		16"	FG1/8-16	



PLAIN END BUTTERFLY LINE VALVES

TRAVIS

Part No.	Size	Price
BV400	4"	
BV600	6"	
BV800	8"	
BV1000	10"	



PIERCE

Part No.	Size	Price
P1800-01	4"	
P1801-01	5"	
P1802-01	6"	
P1803-01	8"	
P1804-01	10"	



GHEEN

Part No.	Size	Price
4616711-0004	4"	
4616711-0005	5"	
4616711-0006	6"	
4616711-0008	8"	
4616711-0010	10"	



BARTOS

Part No.	Size	Price
BLV6	6"	
BLV8	8"	
BLV10	10"	



BAND & LATCH BUTTERFLY LINE VALVES

TRAVIS

Part No.	Size	Price
BLSBV400	4"	
BLSBV600	6"	
BLSBV800	8"	
BLSBV1000	10"	



PIERCE

Part No.	Size	Price
P1812-61	4"	
P1813-61	5"	
P1814-61	6"	
P1815-61	8"	



RING LOCK BUTTERFLY LINE VALVES

TRAVIS

Part No.	Size	Price
SRLBV400	4"	
SRLBV600	6"	
SRLBV800	8"	
SRLBV1000	10"	
SRLBV1200	12"	



PIERCE

Part No.	Size	Price
P1821-61	4"	
P1822-61	5"	
P1823-61	6"	
P1824-61	8"	
P1825-61	10"	
P1826-61	12"	



BARTOS

Part No.	Size	Price
BLV6R	6"	
BLV8R	8"	
BLV10R	10"	



FLANGED BUTTERFLY LINE VALVES

TRAVIS

Part No.	Size	Price
BVFL400	4"	
BVFL600	6"	
BVFL800	8"	
BVFL1000	10"	

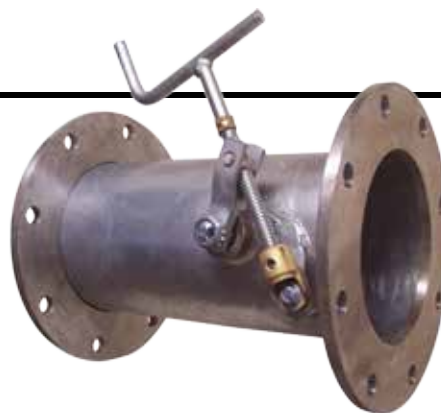

PVC BUTTERFLY LINE VALVES

PVC FITTINGS (FOR SURFACE PIPE)

Part No.	Size	Price
SURGBF001	6"	
SURGBF051	8"	
SURGBF101	10"	
SURGBF151	12"	

Low Pressure 20 PSI Max



PVC FITTINGS (FOR PIP PIPE)

Part No.	Size	Price
PIPSBF001	6"	
PIPSBF051	8"	
PIPSBF101	10"	
PIPSBF151	12"	

Low Pressure 20 PSI Max



INTRO | 1. ELECTRICAL | 2. PUMP, ACC. | 3. HOSE, PE PIPE & ACC. | 4. IPS, PIP PIPE & ACC. | 5. SURFACE | 6. SPRINKLERS | 7. TRAVELER & WHEEL MOVE | 8. PIVOT | 9. TURN | 10. LOW VOLUME | 11. FILTERS | 12. INJECTION | 13. HARDWARE | INDEX

BRASS BALL VALVES

FULL PORT BALL VALVE

Part No.	Size	Price
759T01	1/4"	
759T03	1/2"	
759T04	3/4"	
759T05	1"	
759T06	1-1/4"	
759T07	1-1/2"	
759T08	2"	
759T09	2-1/2"	
759T10	3"	
759T11	4"	



STAINLESS STEEL BALL VALVE

304 FULL PORT BALL VALVE - F X F

Part No.	Size	Price
SC208C	1/4"	
SC208G	1/2"	
SC208I	3/4"	
SC208K	1"	
SC208L	1-1/4"	
SC208M	1-1/2"	
SC208N	2"	



316 FULL PORT BALL VALVE - F X F

Part No.	Size	Price
SC201C	1/4"	
SC201G	1/2"	
SC201I	3/4"	
SC201K	1"	
SC201L	1-1/4"	
SC201M	1-1/2"	
SC201N	2"	
SC201Q	3"	

ELECTRIC ACTUATORS FOR BALL VALVES

ELECTRIC ACTUATORS FOR BALL VALVES

1 1/2" & 2" Stainless steel full port valve, with remote control electric turn actuator and manual override.

Part No.	Size	Price
1.5T23SSRCEL005	1.5"	
2T23SSRCEL005	2"	



BOLTED POLYPROPYLENE BALL VALVES

BEE VALVE FULL PORT

Part No.	Size	Price
4011A-20	1/2"	
4011B-20	3/4"	
4011Y-20	1"	
4011X-20	1-1/4"	
4011D-20	1-1/2"	
4011N-20	2"	
4011W-20	2-1/2"	
4011Z-20	3"	
7012A-20	4"	



BEE VALVE STANDARD PORT

Part No.	Size	Price
4011C-20	1"	
4011E-20	2"	
4011F-20	3"	



BANJO FULL PORT (THREADED)

Part No.	Size	Price
V050	1/2"	
V075	3/4"	
V100FP	1"	
V125FP	1-1/4"	
V150	1-1/2"	
V200FP	2"	
V300FP	3"	



BANJO STANDARD PORT (THREADED)

Part No.	Size	Price
V100	1"	
V125	1-1/4"	
V200	2"	
V300	3"	
V400	4"	



PLASTIC BALL VALVE

SPEARS® SINGLE ENTRY (THREADED OR SOCKET)

Size	Threaded	Socket	Price
1/2"	2421-005G	2422-005G	
3/4"	2421-007G	2422-007G	
1"	2421-010G	2422-010G	
1-1/4"	2421-012G	2422-012G	
1-1/2"	2421-015G	2422-015G	
2"	2421-020G	2422-020G	
3"	2421-030G	2422-030G	
4"	2421-040G	2422-040G	



SPEARS® TRUE UNION (THREADED OR SOCKET)

Size	Threaded	Socket	Price
1/2"	3629-005	3629-005	
3/4"	3629-007	3629-007	
1"	3629-010	3629-010	
1-1/4"	3629-012	3629-012	
1-1/2"	3629-015	3629-015	
2"	3629-020	3629-020	
2-1/2"	3621-025	3622-025	
3"	3621-030	3622-030	
4"	3621-040	3622-040	



SPEARS® UTILITY (THREADED OR SOCKET)

Size	Threaded	Socket	Price
1/2"	2621-005	2622-005	
3/4"	2621-007	2622-007	
1"	2621-010	2622-010	
1-1/4"	2621-012	2622-012	
1-1/2"	2621-015	2622-015	
2"	2621-020	2622-020	
3"	2621-030	2622-030	
4"	2621-040	2622-040	
6"	-	2622-060	



MATCO BALL VALVE (THREADED OR SOCKET)

Size	Threaded	Socket	Price
1/2"	770T03	770S03	
3/4"	770T04	770S04	
1"	770T05	770S05	
1-1/4"	770T06	770S06	
1-1/2"	770T07	770S07	
2"	770T08	770S08	
2-1/2"	770T09	770S09	
3"	770T10	770S10	
4"	770T11	770S11	



INTRO 1. ELECTRICAL 2. PUMP Acc. 3. HOSE, PE PIPE & Acc. 4. IPS, PIP Pipe & Acc. 5. SURFACE 6. SPRINKLERS 7. TRAVELER & WHEEL MOVE 8. PIVOT 9. TURN 10. LOW VOLUME 11. FILTERS 12. INJECTION 13. HARDWARE INDEX

GATE VALVES

CAST IRON GATE VALVES

MATCO FLANGED GATE VALVE -

Part No.	Size	Price
10RW10	3"	
10RW11	4"	
10RW12	5"	
10RW13	6"	
10RW14	8"	
10RW15	10"	
10RW16	12"	



MATCO RING-TITE GATE VALVE -

Part No.	Size	Price
10RT10	3"	
10RT11	4"	
10RT13	6"	
10RT14	8"	



MATCO THREADED GATE VALVE - CAST IRON

Part No.	Size	Price
10RS08	2"	
10RS09	2-1/2"	
10RS10	3"	
10RS11	4"	
10RS12	5"	
10RS13	6"	
10RS14	8"	



FLANGED DUCTILE IRON GATE VALVE (RESILIENT WEDGE - NON RISING STEM)

Part No.	Size	Price
200W08W	2"	
200W10W	3"	
200W11W	4"	
200W13W	6"	
200W14W	8"	
200W15W	10"	
200W16W	12"	



FRESNO LINE GATE VALVE CAST IRON - 4000 SERIES 40B-PW - PVC

Part No.	Size	Price
F040-06002	6"	
F040-08002	8"	
F040-10002	10"	
F040-12002	12"	
F040-14002	15"	
F040-18002	18"	
F040-20002	20"	
F040-24002	24"	



GATE VALVES

MATCO BRASS GATE VALVE

Part No.	Size	Price
514T01	1/4"	
514T03	1/2"	
514T04	3/4"	
514T05	1"	
514T06	1-1/4"	
514T07	1-1/2"	
514T08	2"	
514T09	2-1/2"	
514T10	3"	
514T11	4"	



316 STAINLESS STEEL GATE VALVE

Part No.	Size	Price
SC402G	1/2"	
SC402I	3/4"	
SC402K	1"	
SC402L	1-1/4"	
SC402M	1-1/2"	
SC402N	2"	



HOSE BIBBS & FROST FREE HYDRANTS

BRASS HOSE BIBBS

MATCO HOSE BIBB - BRASS

Part No.	Size	Box Qty.	Price
646R03	1/2" MIPT	12	
646R04	3/4" MIPT	12	
646R05	1" MIPT	12	



MATCO BOILER DRAIN - BRASS

Part No.	Size	Box Qty.	Price
204TF3	1/2" FIPT	12	
204TM3	1/2" MIPT	12	
204TF4	3/4" FIPT	12	
204TM4	3/4" MIPT	12	



MATCO HOSE BIBB BALL VALVE - BRASS

Part No.	Size	Box Qty.	Price
646BV03	1/2" MIPT	12	
646BV04	3/4" MIPT	12	



MATCO BENT NOSE GARDEN VALVE - BRASS

Part No.	Size	Box Qty.	Price
203TF3	1/2" FIPT	12	
203TF4	3/4" FIPT	12	
203TF5	1" FIPT	12	



MATCO NO KINK HOSE BIBB - BRASS

Part No.	Size	Box Qty.	Price
207TF3	1/2" FIPT	12	
207TM3	1/2" MIPT	12	
207TF4	3/4" FIPT	12	
207TM4	3/4" MIPT	12	



MATCO INVERTED NOSE GARDEN VALVE - BRASS

Part No.	Size	Box Qty.	Price
203IF4	3/4" FIPT	12	



FROST FREE HYDRANTS

SIMMONS FROST FREE HYDRANT

Part No.	Bury Depth	Overall Length	Price
4801	1-1/2'	46-3/4"	
4802	2'	52-3/4"	
4803	3'	64-3/4"	
4804	4'	76-3/4"	
4805	5'	88-3/4"	
4806	6'	100-3/4"	
4807	7'	112-3/4"	
4808	8'	124-3/4"	



WOODFORD FREEZELESS YARD HYDRANT

Part No.	Bury Depth	Overall Length	Thread Size	Price
Y34-2	2'	5'	3/4"	
Y34-3	3'	6'	3/4"	
Y34-4	4'	7'	3/4"	
Y34-5	5'	8'	3/4"	
Y1-3	3'	6'	1"	
Y1-4	4'	7'	1"	
Y1-5	5'	8'	1"	
RK-Y34	Repair Kit for Y1			
RK-Y1	Repair Kit for Y34			

CHECK VALVES

MATCO BRASS SWING CHECK VALVE

Part No.	Weight Lbs.	Size	Price
521T03	.43	1/2"	
521T04	.62	3/4"	
521T05	.80	1"	
521T06	1.35	1-1/4"	
521T07	1.67	1-1/2"	
521T08	2.78	2"	
521T09	4.90	2-1/2"	
521T10	5.35	3"	
521T11	6.37	4"	



STAINLESS STEEL SWING CHECK VALVE

Part No.	Weight Lbs.	Size	Price
SC602G	0.7	1/2"	
SC602I	1.0	3/4"	
SC602K	1.5	1"	
SC602L	2.2	1-1/4"	
SC602M	3.3	1-1/2"	
SC602N	4.7	2"	
SC602P	10.0	2-1/2"	
SC602Q	16.7	3"	



BARTOS SWING CHECK VALVE - COMPRESSION

Part No.	Weight Lbs.	Size	Price
BSCV3	30	3"	
BSCV4	32	4"	
BSCV5	42	5"	
BSCV6	44	6"	
BSCV8	65	8"	
BSCV10	130	10"	



ALUMINUM SWING CHECK VALVE - COMPRESSION

Part No.	Weight Lbs.	Size	Price
VACH6	28	6"	
VACH8	35	8"	
VACH10	60	10"	



MATCO CAST IRON WAFER CHECK VALVE

Part No.	Weight Lbs.	Size	Price
CVC-3	8	3"	
CVC-4	12	4"	
CVC-5	19	5"	
CVC-6	21	6"	
CVC-8	34	8"	
CVC-10	56	10"	
CVC-12	71	12"	



NUT & BOLT SETS FOR WAFER CHECK VALVES

NUT AND BOLT SET

Size	Steel x WCV x Steel		PVC x WCV x PVC		Steel x WCV x PVC		CF x WCV x CF	
	Part No.	Price	Part No.	Price	Part No.	Price	Part No.	Price
2"	NBS5/8x4		NBS5/8x5		NBS5/8x4		NBS5/8x4	
2.5"	NBS5/8x4		NBS5/8x5		NBS5/8x5		NBS5/8x5	
3"	NBS5/8x5		NBS5/8x6		NBS5/8x5		NBS5/8x5	
4"	NBS5/8x5		NBS5/8x6		NBS5/8x6		NBS5/8x6	
5"	NBS3/4x5		NBS3/4x6		NBS3/4x6		NBS3/4x6	
6"	NBS3/4x6		NBS3/4x7.5		NBS3/4x6		NBS3/4x7.5	
8"	NBS3/4x6		NBS3/4x7.5		NBS3/4x7.5		NBS3/4x7.5	
10"	NBS7/8x7.5		NBS7/8x8.5		NBS7/8x7.5		NBS7/8x8.5	
12"	NBS7/8x7.5		NBS7/8x8.5		NBS7/8x8.5		NBS7/8x8.5	

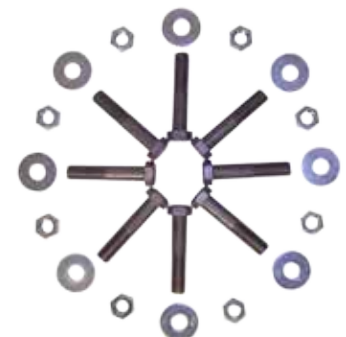

KBI PVC SPRING CHECK VALVE

Threaded Part No.	Socket Part No.	Size	Price
KC2-1000-T	KC2-1000-S	1"	
KC2-1250-T	KC2-1250-S	1-1/4"	
KC2-1500-T	KC2-1500-S	1-1/2"	
KC2-2000-T	KC2-2000-S	2"	



KBI PVC SWING CHECK VALVE

Threaded Part No.	Socket Part No.	Size	Price
KSC-1000-T	KSC-1000-S	1"	
KSC-1250-T	KSC-1250-S	1-1/4"	
KSC-1500-T	KSC-1500-S	1-1/2"	
KSC-2000-T	KSC-2000-S	2"	
-	KSC-3000-S	3"	
-	KSC-4000-S	4"	



SPEARS CLEAR PVC SWING CHECK VALVE

Threaded Part No.	Socket Part No.	Size	Price
S1520C05F	S1520C05	1/2"	
S1520C07F	S1520C07	3/4"	
S1520C10F	S1520C10	1"	
S1520C12F	S1520C12	1-1/4"	
S1520C15F	S1520C15	1-1/2"	
S1520C20F	S1520C20	2"	
S1520C25F	S1520C25	2-1/2"	
S1520C30F	S1520C30	3"	
S1520C40F	S1520C40	4"	
S1520C60F	S1520C60	6"	
-	S1520C80	8"	



SPEARS CLEAR PVC SPRING CHECK VALVE

Threaded Part No.	Socket Part No.	Size	Price
S1580C05F	S1580C05	1/2"	
S1580C07F	S1580C07	3/4"	
S1580C10F	S1580C10	1"	
S1580C12F	S1580C12	1-1/4"	
S1580C15F	S1580C15	1-1/2"	
S1580C20F	S1580C20	2-1/2"	
S1580C25F	S1580C25	2"	
S1580C30F	S1580C30	3"	
S1580C40F	S1580C40	4"	



SPEARS WHITE PVC SPRING CHECK VALVE

Threaded Part No.	Socket Part No.	Size	Price
S1580-05F	S1580-05	1/2"	
S1580-07F	S1580-07	3/4"	
S1580-10F	S1580-10	1"	
S1580-12F	S1580-12	1-1/4"	
S1580-15F	S1580-15	1-1/2"	
S1580-20F	S1580-20	2-1/2"	
S1580-25F	S1580-25	2"	
S1580-30F	S1580-30	3"	
S1580-40F	S1580-40	4"	



INTRO
 1. ELECTRICAL
 2. PUMP ACC.
 3. HOSE, PE PIPE & ACC.
 4. IPS, PIP PIPE & ACC.
 5. SURFACE
 6. SPRINKLERS
 7. TRAVELER & WHEEL MOVE
 8. PIVOT
 9. TURF
 10. LOW VOLUME
 11. FILTERS
 12. INJECTION
 13. HARDWARE
 INDEX

CHECK VALVES

CLEARVIEW SIGHT CHECK VALVES

CLEARVIEW SIGHT CHECKS - COMPLETE

4" Length			6" Length			8" Length		
Part No.	Size	Price	Part No.	Size	Price	Part No.	Size	Price
SC2	2"		SC2-LCV	2"		SC2/LCV	2"	
SC21/2	2-1/2"		SC21/2-LCV	2-1/2"		SC21/2/LCV	2-1/2"	
SC3	3"		SC3-LCV	3"		SC3/LCV	3"	
SC4	4"		SC4-LCV	4"		SC4/LCV	4"	
SC5	5"		SC5-LCV	5"		SC5/LCV	5"	
SC6	6"		SC6-LCV	6"		SC6/LCV	6"	
SC8	8"		SC8-LCV	8"		SC8/LCV	8"	



REPLACEMENT SIGHT CHECK VALVE BODY

	Part No.	Size	Price
Please Note: Sizes 2" & 2-1/2" have the valve body flapper assembly built-in to the clearview sleeve. Sizes 3" through 8" are made in a steel valve body & comes with 2 gaskets.	REP/SC2	2" x 4" Long	
	REP/SC2-LCV	2" x 6" Long	
	REP/SC2/LCV	2" x 8" Long	
	REP/SC21/2	2-1/2" x 4" Long	
	REP/SC21/2-LCV	2-1/2" x 6" Long	
	REP/SC21/2/LCV	2-1/2" x 8" Long	
	REP/SC3	3"	
	REP/SC4	4"	
	REP/SC5	5"	
	REP/SC6	6"	
REP/SC8	8"		



CLEARVIEW SIGHT CHECK LENS

4" Length			6" Length			8" Length		
Part No.	Size	Price	Part No.	Size	Price	Part No.	Size	Price
CV3	3"		CV3-L	3"		CV3/L	3"	
CV4	4"		CV4-L	4"		CV4/L	4"	
CV5	5"		CV5-L	5"		CV5/L	5"	
CV6	6"		CV6-L	6"		CV6/L	6"	
CV8	8"		CV8-L	8"		CV8/L	8"	



FLAP ASSEMBLY & PARTS

Complete Flap Assembly			Flap Only w/ Bolts & Washers			Flap Weight w/ Bolts & Washers		
Part No.	Size	Price	Part No.	Size	Price	Part No.	Size	Price
FLAP=2	2"		FLAP+2	2"		TAB+2	2"	
FLAP=21/2	2-1/2"		FLAP+21/2	2-1/2"		TAB+21/2	2-1/2"	
FLAP=3	3"		FLAP+3	3"		TAB+3	3"	
FLAP=4	4"		FLAP+4	4"		TAB+4	4"	
FLAP=5	5"		FLAP+5	5"		TAB+5	5"	
FLAP=6	6"		FLAP+6	6"		TAB+6	6"	
FLAP=8	8"		FLAP+8	8"		TAB+8	8"	



CLEARVIEW ACCESSORIES

Rings			Gaskets			Bolts w/Nuts		
Part No.	Size	Price	Part No.	Size	Price	Part No.	Size	Price
RING2	2"		102407	2"		CBOLT6	6"	
RING21/2	2-1/2"		102408	2-1/2"		CBOLT7	7"	
RING3	3"		102409	3"		CBOLT8	8"	
RING4	4"		102410	4"		CBOLT10	10"	
RING5	5"		102412	5"				
RING6	6"		102414	6"				
RING8	8"		102418	8"				

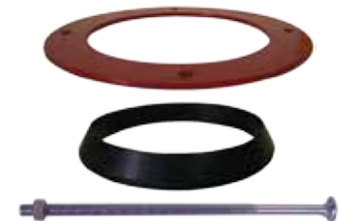

CHECK VALVES

CLEARVIEW SIGHT CHECK VALVES

CLEARVIEW SIGHT CHECK GROOVED ENDS

Part No.	Size	Price
DK015G	2"	
DK016G	2.5"	
DK017G	3"	
DK018G	4"	
DK020G	6"	



TRAVIS GALVANIZED CHECK VALVES

FLANGED

Part No.	Size	Price
CKVFL4	4"	
CKVFL6	6"	
CKVFL8	8"	
CKVFL10	10"	



PLAIN END

Part No.	Size	Price
CKVP4	4"	
CKVP6	6"	
CKVP8	8"	
CKVP10	10"	



PIERCE GALVANIZED CHECK VALVES

FLANGED

Part No.	Size	Price
P1755-01	4"	
P1753-01	6"	
P1753-02	8"	
P1753-03	10"	
P3797-01	12"	
P0051-26	14"	



PLAIN END

Part No.	Size	Price
P1752-05	3"	
P1754-01	4"	
P0033-01	5"	
P1752-01	6"	
P1752-02	8"	
P1752-03	10"	
P3859-01	12"	



CHEMIGATION VALVES

PIERCE GALVANIZED CHEMIGATION CHECK VALVES

FLANGED

Part No.	Size	Price
P1775-61	4"	
P1778-61	6"	
P1778-62	8"	
P1778-63	10"	
P3645-61	12" x 10" x 12"	
P3798-01	12"	

Flange x Wedge-Tite also available

WEDGE-TITE®

Part No.	Size	Price
P0035-72	4"	
P3649-01	6"	
P3650-01	8"	
P3651-01	10"	

Note: Priced with flange packs.



INTRO 1. ELECTRICAL 2. PUMP Acc. 3. HOSE, PE PIPE & Acc. 4. IPS, PIP Pipe & Acc. 5. SURFACE 6. SPRINKLERS 7. TRAVELER & WHEEL MOVE 8. PIVOT 9. TURN 10. LOW VOLUME 11. FILTERS 12. INJECTION 13. HARDWARE INDEX

TRAVIS GALVANIZED CHEMIGATION CHECK VALVES

FLANGED

Part No.	Size	Price
CHEMVFL4	4"	
CHEMVFL6	6"	
CHEMVFL8	8"	
CHEMVFL10	10"	

BOLT TITE

Part No.	Size	Price
CHEMVBT4	4"	
CHEMVBT6	6"	
CHEMVBT8	8"	
CHEMVBT10	10"	

Note: Priced with flange packs.



KROY-MIDWEST GALVANIZED CHEMIGATION CHECK VALVES

CVMW FLANGED

Part No.	Size	Price
SH300006	6"	
SH300008	8"	
SH300010	10"	
SH300012	12"	

CVMW FLANGED X WATERTIGHT

Part No.	Size	Price
SH300206	6"	
SH300208	8"	
SH300210	10"	
SH300212	12"	

Note: Priced with flange packs.

CVMW WATERTIGHT

Part No.	Size	Price
SH300306	6"	
SH300308	8"	
SH300310	10"	
SH300312	12"	

Note: Priced with flange packs.



PVC CHEMIGATION DRAIN CHECK VALVE

CHEMIGATION POPPET DRAIN CHECK VALVE

Part No.	Size	Price
DRNHOSE	1" MIPT Inlet x 3/4" MGHT Outlet	



VERTICAL FOOT VALVES

FLOMATIC 60SE ENVIRO-CHECK® - BRASS FIPT

Part No.	Size	Price
4100E	3/4"	
4101E	1"	
4102E	1-1/4"	
4104E	1-1/2"	
4105E	2"	
4106E	2-1/2"	
4107E	3"	
4108E	4"	



SURE-FLO FLANGED CONNECTION - ALUM.

Part No.	Size	Price
SFVV2CF	2"	
SFVV3CF	3"	
SFVV4CF	4"	
SFVV5CF	5"	
SFVV6CF	6"	
SFVV8CF	8"	
SFVV10CF	10"	
SFVV12CF	12"	



SURE-FLO OD TUBING CONNECTION - ALUM.

Part No.	Size	Price
SFVV3	3"	
SFVV4	4"	
SFVV5	5"	
SFVV6	6"	
SFVV8	8"	
SFVV10	10"	



SURE-FLO FIPT CONNECTION - ALUMINUM

Part No.	Size	Price
SFVV2FP	2"	
SFVV3FP	3"	
SFVV4FP	4"	
SFVV5FP	5"	
SFVV6FP	6"	
SFVV8FP	8"	
SFVV10FP	10"	



45° FOOT VALVES

SURE-FLO OD TUBING CONNECTION - ALUM.

Part No.	Size	Price
SFV2	2"	
SFV3	3"	
SFV4	4"	
SFV5	5"	
SFV6	6"	
SFV8	8"	
SFV10	10"	



SURE-FLO FLANGED CONNECTION - ALUM.

Part No.	Size	Price
SFV2CF	2"	
SFV3CF	3"	
SFV4CF	4"	
SFV5CF	5"	
SFV6CF	6"	
SFV8CF	8"	
SFV10CF	10"	



SURE-FLO FOOT VALVE SCREEN

Part No.	Size	Material	Price
SOV2	2"	Aluminum	
SOV3	3"	Aluminum	
SOV3SS	3"	Stainless Steel	
SOV4	4"	Aluminum	
SOV4SS	4"	Stainless Steel	
SOV5	5"	Aluminum	
SOV5SS	5"	Stainless Steel	
SOV6	6"	Aluminum	
SOV6SS	6"	Stainless Steel	
SOV8	8"	Aluminum	
SOV8SS	8"	Stainless Steel	
SOV10	10"	Aluminum	
SOV10SS	10"	Stainless Steel	

SURE-FLO FIPT CONNECTION - ALUM.

Part No.	Size	Price
SFV2FP	2"	
SFV3FP	3"	
SFV4FP	4"	
SFV5FP	5"	
SFV6FP	6"	
SFV8FP	8"	
SFV10FP	10"	



INTRO 1. ELECTRICAL 2. PUMP ACC. 3. HOSE, PE PIPE & ACC. 4. IPS, PIP PIPE & ACC. 5. SURFACE 6. SPRINKLERS 7. TRAVELER & WHEEL MOVE 8. PIVOT 9. TURF 10. LOW VOLUME 11. FILTERS 12. INJECTION 13. HARDWARE INDEX

CONTROL VALVES

NELSON 800 SERIES CONTROL VALVES



Nelson 800 Series Valves are available in a variety of configurations for all types of irrigation systems. They have a barrel style design that minimizes friction losses and allows high flow rates. Valve body sizes 2", 3", and 4" are constructed of anodized aluminum while 6" and 8" bodies are galvanized steel, all with epoxy coated cast iron cages inside. Example valves are listed directly below. Custom design your valve by adding together the various options. Pressure reducing and sustaining pilots, rate of flow, solenoids, and filters (sections D, E, and H) are also available as separate add-on kits. Each valve is custom built to order and tested before shipment.

BASE VALVE				ACCESSORIES									
A	B		C		D				E		H		
Size / Material	Connection Style & Hardware		Operating Pressure		Pressure / Flow Control				On / Off Mode		Filter		
Aluminum	Wafer Style				None				Manual				
A2" Aluminum -	B9	(No Studs) Includes Manual Selector & Mounting Bracket Kits	C1	10-50 PSI	D01				E1		No Solenoid	H2	External
					Reducing (small body pilot)				Electric Solenoid DC (voltage, orifice diameter)				
	B10	(4 studs, 8 nuts) Includes Manual Selector & Mounting Bracket Kits	C2	30-200 PSI	D11		Reducing 3-25 PSI		E21		12VDC 1/16"	H3	Internal for 2" & 3"
					D12		Reducing 5-50 PSI		E34		24VDC 3/64"		
A3" Aluminum -	B11	Wafer for Big Gun ANSI w/ bolts 4 studs & 4 nuts (To include Manual On-Off Control specify D01)	C3	18-80 PSI	D13		Reducing 10-120 PSI		DC Latching				
					Sustaining (small body pilot)								
	B12	Wafer for Big Gun ANSI w/o bolts (To include Manual On-Off Control specify D01)			D15		Sustaining 5-50 PSI		E27		12VDC, 1/16"		
					D16		Sustaining 10-120 PSI		E28		12-50V, 11/128"		
Cast Iron	Threaded				Rate-of-Flow				AC (voltage, orifice diameter)				
A2" Cast Iron -	B3	(Specify NPT or BSP) Includes Manual Selector & Mounting Bracket Kits			D18		Specify flow rate and pipe size		E43		24VAC (.13 AMP)		
					Sleeve Exhaust								
A3" Cast Iron -	Victaulic				D6		Sleeve Exhaust		E53		120VAC		
	B6	Includes Manual Selector & Mounting Bracket Kits			Shuttle Check								
					D7		Shuttle Check Valve (Must accompany solenoid or sustaining ctrl.)						
Aluminum	Wafer Style				None				Manual				
A4" -	B9	(No Studs) Includes Manual Selector & Mounting Bracket Kits	C1	10-50 PSI	D01				E1		No Solenoid	H2	External
					Reducing (large body pilot)				Electric Solenoid DC (voltage, orifice diameter)				
	B10	(8 studs, 16 nuts) Includes Manual Selector & Mounting Bracket Kits	C2	30-200 PSI	D2		Reducing 5-50 PSI		E21		12VDC 1/16"	H3	Internal for 4"
					D3		Reducing 10-120 PSI		E30		24VAC 1/16"		
				C3	18-80 PSI	D4		Reducing 25-200 PSI	DC Latching				
				Sustaining (large body pilot)									
				D5		Sustaining 25-200 PSI		E28		12-50V, 11/128"			
				D8		Sustaining 10-120 PSI		AC (voltage, orifice diameter)					
				D9		Sustaining 5-50 PSI		E40		24VAC 1/16" (.15 AMP)			
				Rate-of-Flow									
				D18		Specify flow rate and pipe size		E46		24VAC 1/16" (.08 AMP)			
				Sleeve Exhaust									
				D6		Sleeve Exhaust		E50		120VAC 1/16"			
				Shuttle Check									
				D7		Shuttle Check Valve (Must accompany solenoid or sustaining ctrl.)		E52		120VAC 1/16" (6" & 8" Valve Only)			
Cast Iron	Wafer Style				Rate-of-Flow								
A4" -	B4	(No Studs) Includes Manual Selector & Mounting Bracket Kits											
					Rate-of-Flow								
A6" -	B5	(8 studs, 16 nuts) Includes Manual Selector & Mounting Bracket Kits											
					Rate-of-Flow								
				Sleeve Exhaust									
				D6		Sleeve Exhaust		E50		120VAC 1/16"			
				Shuttle Check									
				D7		Shuttle Check Valve (Must accompany solenoid or sustaining ctrl.)		E52		120VAC 1/16" (6" & 8" Valve Only)			

NETAFIM™ CONTROL VALVES

Netafim™ Control Valves are available in a wide range of sizes and flow rates to cover most applications. These iron valves have a protective polyester coating that is resistant to corrosive elements. The unique design allows a straight flow pattern with low friction loss. A direct sealing diaphragm, the valves only moving part, operates by pipeline or external pressure. Sizes range from 1" to 24" with a variety of control functions and connection options. These valves are excellent for high pressure applications, drip and sprinkler irrigation systems, or for linear and center pivot control. Maximum working pressure is 230 PSI. Optional control functions include: manual, electrical, pressure reducing, pressure sustaining, remote control and flow control. Each valve is custom built to order and tested before shipping.



BASIC VALVES

Part No.	Description	Price
61B2IT-XX	2" Basic Hydraulic Control*	
61B2-TH-AN	2" Basic Angle Hydraulic Threaded	
61B4IF-XX	4" Basic Hydraulic Flange*	
61B6IFCP	6" Basic Hydraulic Flange	
61B8IFCP	8" Basic Hydraulic Flange	
61B868IF-XX	868 Basic Hydraulic Flange	
61B10IF	10" Basic Hydraulic Flange	
* Substitute XX with HP or LP.		

MANUAL VALVES

Part No.	Description	Price
61M2IT-HP	2" Manual Threaded	
61M4IF-HP	4" Manual Flange	
61M6IF-HP	6" Manual Flange	
61M868IF-HP	868 Manual Flange	
61M8IF	8" Manual Flange	
61M10IF	10" Manual Flange	

ELECTRIC VALVES-120V

Part No.	Description	Price
61EL2IT-HPCP	2" Electric Threaded	
61EL2B-ANCP	2" Angle Electric Threaded	
61EL4IFCP	4" Electric Flange	
61EL6IFCP	6" Electric Flange	
61EL8IFCP	8" Electric Flange	
61EL868IFCP	868 Electric Flange	
61EL10IF	10" Electric Flange	

MANUAL ELECTRIC VALVES

Part No.	Description	Price
61MEL2IT-HP	2" Manual Electric Threaded	
61MEL4IFCP	4" Manual Electric Flange	
61MEL6IFCP	6" Manual Electric Flange	
61MEL868IF-HP	868 Manual Electric Flange	
61MEL8IF	8" Manual Electric Flange	
61MEL10IF	10" Manual Electric Flange	

PRESSURE REDUCING VALVES-120V

Part No.	Description	Price
61PREL4IFCP-X	4" Pressure Reducing Electric Flange	
61PR4IF-X	4" Pressure Reducing Valve Flange	
61PREL6IFCP-X	6" Pressure Reducing Electric Flange	
61PR6IF-X	6" Pressure Reducing Valve Flange	
61PREL8IFCP-X	8" Pressure Reducing Electric Flange	
61PR8IF-X	8" Pressure Reducing Valve Flange	
61PREL868IFCP-X	868 Pressure Reducing Electric Flange	
61PR868IF-X	868 Pressure Reducing Valve Flange	
61PREL10IF-X	10" Pressure Reducing Electric Flange	
61PR10IF-X	10" Pressure Reducing Valve Flange	
Substitute X with Y, G or B for downstream pressure.		

PRESSURE REDUCING VALVE SPRING RANGES

Part No.	Description
1" to 4" Valves Spring Range:	Y - Yellow (7-30 PSI)
	G - Green (14-65 PSI)
	R - Red (30-90 PSI)
6" to 24" Valves Spring Range:	Y - Yellow (8-45 PSI)
	G - Green (14-90 PSI)
	B - Black (100-285 PSI)

INTRO | 1. ELECTRICAL | 2. PUMP ACC. | 3. HOSE, PE PIPE & ACC. | 4. IPS, PIP PIPE & ACC. | 5. SURFACE | 6. SPRINKLERS | 7. TRAVELER & WHEEL MOVE | 8. PIVOT | 9. TURF | 10. LOW VOLUME | 11. FILTERS | 12. INJECTION | 13. HARDWARE | INDEX

XCAD AUTOMATIC CONTROL VALVES

X-MAX VALVES

Part No.	Description	Price
XMAX6B	6"Basic Valve	
XMAX6WS	6"Electric On/Off Valve	



SMV BASIC VALVES

Part No.	Description	Price
SMV75B	3/4" NPT Threaded	
SMV1B	1" NPT Threaded	
SMV2B	2" NPT Threaded	
SMV902B	2" 90° NPT Threaded	
SMV3B	3" NPT Threaded	
SMV4B	4" Flanged	
SMV6B	6" Flanged	



SMV ELECTRIC ON/OFF

Part No.	Description	Price
SMV75WS	3/4" NPT Threaded	
SMV1WS	1" NPT Threaded	
SMV2WS	2" NPT Threaded	
SMV902WS	2" 90° NPT Threaded	
SMV3WS	3" NPT Threaded	
SMV4WS	4" Flanged	
SMV6WS	6" Flanged	



SMV DIAPHRAGM

Part No.	Description	Price
SMV75DIA	3/4" Diaphragm	
SMV1DIA	1" Diaphragm	
SMV2DIA	2" Diaphragm	
SMV3DIA	3" Diaphragm	
SMV4DIA	4" Diaphragm	
SMV6DIA	6" Diaphragm	



JOBE™ FLOAT VALVES

ROJO™ FLOAT VALVE

Rojo™ Float Valves are float operated valves for automatic filling of water storage vessels. The Rojo™ can be mounted above or below water level. It is a simple mechanically operated valve. The Rojo™ is a good choice where low flow is sufficient and its compact non-corrosive construction is beneficial.

ROJO™ FLOW RATE IN GPM				
Size	15 PSI	30 PSI	45 PSI	60 PSI
1/2" & 3/4"	2	2.8	3.6	4
3/4" High Flow	3	4.3	5.6	6.3

Mounting Positions

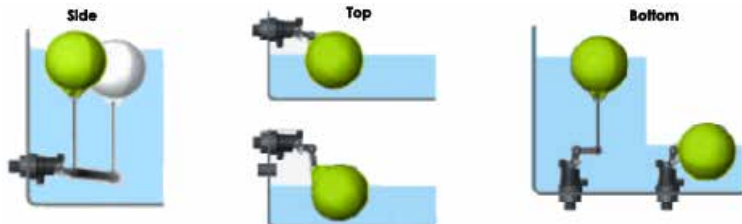

Part No.	Description	Price
RJV15	1/2" Rojo™ Valve	
RJV20	3/4" Rojo™ Valve	
RJV20LP	3/4" High Flow Rojo™ Valve	

TOPAZ™ TROUGH VALVE

Topaz™ Trough Valves are float operated valves for use in automatic filling of water troughs, tanks, cisterns, irrigation applications, etc. The valve is configured for above or below water mounting. The float operates a small pilot valve which in turn operates the main diaphragm valve. Topaz™ Trough Valves are a good choice where their high flow, compact, robust, non-corrosive construction and high level of adaptability are needed.

TOPAZ™ FLOW RATE IN GPM				
Size	15 PSI	30 PSI	45 PSI	60 PSI
3/4"	37	50	59	63
1" & 1-1/4"	42	59	77	90

Mounting Positions

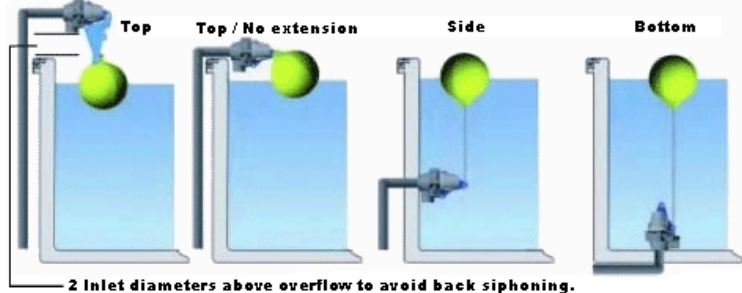

Part No.	Description	Price
TPV20DLT	Topaz™ Valve 3/4" Detach	
TPV1DLT	Topaz™ Valve 1" Detach	
TPV11/4D	Topaz™ Valve 1-1/4" Detach	
FPV	Frost Pro Freeze Prevention Device	

FROSTPRO is a device that fits Topaz Valves to minimize freezing in cold weather conditions. It allows a continuous flow of water through the valve to assist in the prevention of water freezing in the valve and the pipe work supplying it.

PROTECT-A-MOUNT

Holds 3/4" valve & protects from livestock damage (above water only)

Part No.	Description	Price
PMV	Protect A Mount (for Rojo & Topaz)	



Features

- Side, Bottom or Top mounting
- Valve body screws apart by hand for easy servicing
- Flow stops when unscrewed for servicing
- Available with 1/2" & 3/4" threads
- Built-in check valve
- Fully adjustable float angle
- Non-corrosive material construction
- Pressure Range 0-150 PSI
- Low Pressure model available which allows 60% more flow
- Has switch to lock valve in off position



Features

- High flow rate
- Side, Bottom or Top mounting
- Float position easily adjustable without tools
- Shuts down slowly to minimize water hammer
- Valve has switch to lock it in off position
- Has port to connect Frostpro anti-freeze device
- Pressure rating 5-100 PSI
- 3/4" - 2-1/2" Water level differential (increases as water inlet pressure increases)
- Available in 3/4", 1" and 1-1/4"

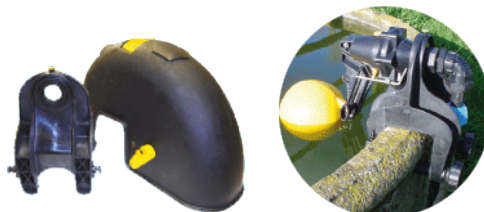

JOBE™ FLOAT VALVES

VORTEX STANDARD VALVE

Vortex Float Valves are float operated valves for use in automatic filling of water tanks, troughs, cisterns etc. The valve is configured for above water mounting. The float operates a small pilot valve which in turn operates the main diaphragm valve. Vortex float valves are a good choice where maximum flow, compact, robust, non corrosive construction and variable float levels are required.

Part No.	Description	Price
VXV114	Vortex 1-1/4" Top Fill	
VXV112	Vortex 1-1/2" Top Fill	
VXV2	Vortex 2" Top Fill	

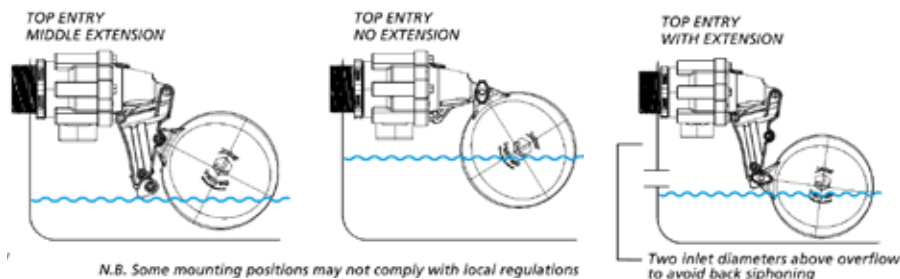

VORTEX BOTTOM FILL VALVE

Vortex Bottom Fill Valves are configured for underwater mounting only. The float is connected to the valve with a nylon cord, this operates a pilot valve, when the water level drops, the pilot valve is opened and the main diaphragm valve is activated. Vortex is a good choice where its high flow, compact, robust, non-corrosive construction is beneficial.

Part No.	Description	Price
VXVB114	Vortex 1-1/4" Bottom Fill	
VXVB112	Vortex 1-1/2" Bottom Fill	
VXVB2	Vortex 2" Bottom Fill	

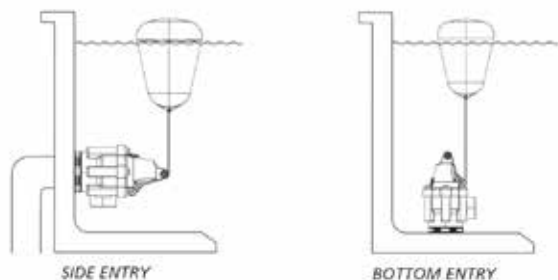

Vortex Standard & Bottom Fill Features

- High flow
- Compact robust construction
- Mounts horizontally or vertically
- Made from corrosion resistant materials
- Valve unscrews from tail for easy valve seal access
- Shuts down slowly to minimize water hammer
- 20 - 60mm (3/4" - 2 1/2") water level differential (increases as water inlet pressure increases)
- Pressure rating 0.3 - 7 Bar (5 - 100 PSI)
- Float position easily adjustable with no tools
- Valve has switch to lock it in off position
- Has port to connect Frostpro anti freeze device

VORTEX DIFFERENTIAL VALVE

Vortex Differential Valves are ideal for use in water tanks which are filled by a pressure system controlled water pump. The valve gives a level difference which is adjustable from 50mm to 2.5m to minimize starting and stopping of the pumping system.

Part No.	Description	Price
VXVD114	Vortex Differential 1-1/4" NPT	
VXVD112	Vortex Differential 1-1/2" NPT	
VXVD2	Vortex Differential 2" NPT	

Typical Installation

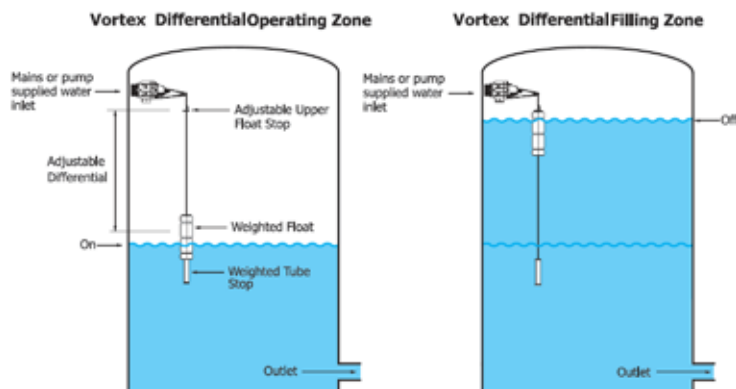

Principle of Operation

- The valve should be mounted at the top of the tank using a threaded tank inlet fitting.
- As the tank empties the weighted float travels down the cord until it hits the bottom stop. The valve then opens immediately to give a full flow.

- Observe the pressure that your pump runs at while the tank is filling. Set the pressure switch to turn the pump off at least one bar above the running pressure.

Pressure Range
1 Bar – 10 Bar
(15psi-150 psi)

Applications

- Maintaining Water Levels in:
- Water Storage Tanks
 - Water Cisterns
 - Irrigation Applications

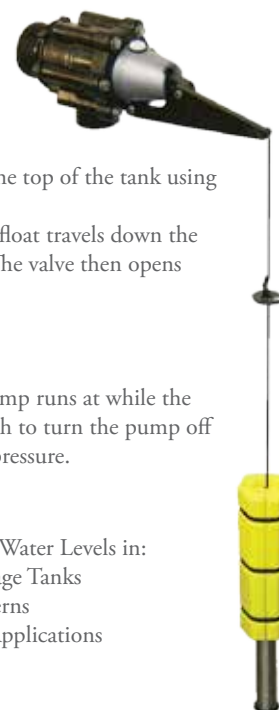

JOBE™ FLOAT VALVES

MEGAFLOW™ TROUGH VALVE

Megaflow™ Trough Valves are float operated valves for use in automatic filling of water troughs. The valve is configured for under water mounting only. The float is connected to the valve with a nylon cord which operates a pilot valve. When the water level drops, the main diaphragm valve is activated. Megaflow™ is a good choice where its high flow, compact, robust, non-corrosive construction is beneficial.

MEGAFLOW™ FLOW RATE IN GPM				
Size	15 PSI	30 PSI	45 PSI	60 PSI
3/4"	37	50	59	63
1" & 1-1/4"	42	59	77	90

Mounting Positions

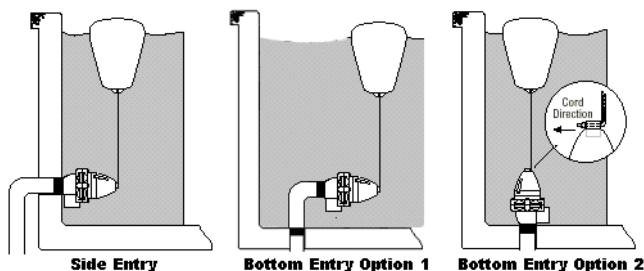

Part No.	Description	Price
MFV20DLT	Megaflow™ 3/4" Detach	
MFV1DLT	Megaflow™ 1" Detach	
MFV11/4D	Megaflow™ 1-1/4" Detach	



Features

- High flow rate
- Side or bottom mounting
- Under water installation helps avoid freezing
- Valve is less prone to stock damage
- Positive on/off operation
- Lock off with cord lock
- Inlet filter
- Pressure rating 5-150PSI
- 3/4" - 2-1/2" Water level differential (increases as water pressure increases)
- Available in 3/4", 1" and 1-1/4"

BOB® FLOAT VALVES

BOB® Float Valves are used for many applications including livestock waterers, evaporative coolers, swimming pools, cooling towers, etc. Depending on your application and job requirements a wide variety of options are available to select from that will produce the right valve to meet your needs. Here, we are offering the model R400 Valve Assembly which provides the following features:

R400 FLOW RATE IN GPM				
Size	15 PSI	25 PSI	35 PSI	55 PSI
1/2"	8.5	10	12	16
3/4"	12.1	15.2	21	28.8
1"	24	37.8	43.5	55

Mounting Position

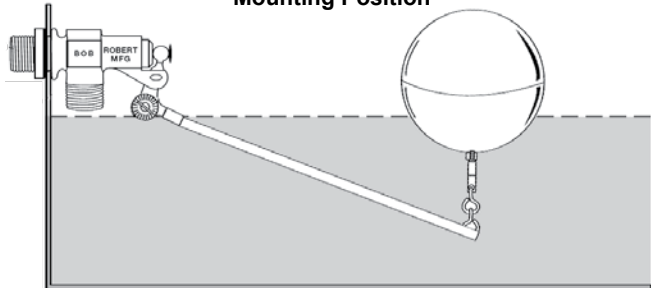

Part No.	Description	Price
R400-1/2-3P	1/2" Brass Float Valve Assembly	
R400-3/4-3P	3/4" Brass Float Valve Assembly	
R400-1-3P	1" Brass Float Valve Assembly	



Features

- Precision machined red brass body
- 1/2", 3/4" or 1" MPT Inlet/Outlet
- Buna-N Disc - Polypropylene Ball
- 1/4" - 20" x 10" Stem & Swivel Assembly
- High Capacity - Heavy Duty
- Withstands over 100 PSI
- Pressure rating 5-100 PSI
- Contoured valve seat for positive shutoff
- Serrated short arm & thumbscrew for accurate & trouble-free adjustment
- Swiveling float ends damage from livestock nuzzling

CLEARVIEW COUPLINGS

CLEARVIEW COUPLINGS - COMPLETE

4" Length			6" Length			8" Length		
Part No.	Size	Price	Part No.	Size	Price	Part No.	Size	Price
CVC2	2"		CVC2-L	2"		CVC2/L	2"	
CVC21/2	2-1/2"		CVC21/2-L	2-1/2"		CVC21/2/L	2-1/2"	
CVC3	3"		CVC3-L	3"		CVC3/L	3"	
CVC4	4"		CVC4-L	4"		CVC4/L	4"	
CVC5	5"		CVC5-L	5"		CVC5/L	5"	
CVC6	6"		CVC6-L	6"		CVC6/L	6"	
CVC8	8"		CVC8-L	8"		CVC8/L	8"	



CLEARVIEW LENS

4" Length			6" Length			8" Length		
Part No.	Size	Price	Part No.	Size	Price	Part No.	Size	Price
CV2	2"		CV2-L	2"		CV2/L	2"	
CV21/2	2-1/2"		CV21/2-L	2-1/2"		CV21/2/L	2-1/2"	
CV3	3"		CV3-L	3"		CV3/L	3"	
CV4	4"		CV4-L	4"		CV4/L	4"	
CV5	5"		CV5-L	5"		CV5/L	5"	
CV6	6"		CV6-L	6"		CV6/L	6"	
CV8	8"		CV8-L	8"		CV8/L	8"	



CLEARVIEW ACCESSORIES

Rings			Gaskets			Bolts w/Nuts		
Part No.	Size	Price	Part No.	Size	Price	Part No.	Size	Price
RING2	2"		102407	2"		CBOLT6	6"	
RING21/2	2-1/2"		102408	2-1/2"		CBOLT7	7"	
RING3	3"		102409	3"		CBOLT8	8"	
RING4	4"		102410	4"		CBOLT10	10"	
RING5	5"		102412	5"				
RING6	6"		102414	6"				
RING8	8"		102418	8"				



DRESSER STYLE COUPLINGS

DRESSER STYLE COUPLING WITH STEEL BARREL

IPS - Black Flanges			O.D - Blue Flanges		
Part No.	Size	Price	Part No.	Size	Price
F090-120A03	3"		-	3"	
F090-120A04	4"		F090-120B04	4"	
F090-120A05	5"		F090-120B05	5"	
F090-120A06	6"		F090-120B06	6"	
F090-120A08	8"		F090-120B08	8"	
F090-120A10	10"		F090-120B10	10"	
F090-120A12	12"		F090-120B12	12"	
-	14"		F090-120B14	14"	
-	16"		F090-120B16	16"	



BARTOS BOLTED COUPLERS

OD GRAY BOLTED COUPLER

Part No.	Size	Body Length	Weight Lbs.	Price
BCPD3	3"	6"	4.5	
BCPD4	4"	6"	6	
BCPD5	5"	6"	7.5	
BCPD6	6"	6"	9	
BCPD8	8"	6"	11	
BCPD10	10"	6"	16	
BCPD12	12"	6"	19	
BCPD14	14"	12"	35	
BCPD16	16"	12"	37	
BCPD18	18"	18"	50	
BCPD20	20"	18"	68	



IPS SHORT RED BOLTED COUPLER

Part No.	Size	Body Length	Weight Lbs.	Price
BCPP2	2"	6"	4	
BCPP250	2-1/2"	6"	4.5	
BCPP3	3"	6"	6	
BCPP4	4"	6"	7	
BCPP5	5"	6"	8	
BCPP6	6"	6"	9.5	
BCPP8	8"	6"	14	
BCPP10	10"	6"	15	
BCPP12	12"	6"	18.5	



IPS LONG RED BOLTED COUPLER

Part No.	Size	Body Length	Weight Lbs.	Price
BCPP3L	3"	10"	8	
BCPP4L	4"	10"	10	
BCPP6L	6"	10"	13	
BCPP8L	8"	12"	21	
BCPP10L	10"	12"	24	
BCPP12L	12"	12"	29	
BCPP14	14"	12"	35	
BCPP16	16"	12"	37	
BCPP18	18"	18"	50	
BCPP20	20"	18"	68	



WEDGE-TITE® COUPLER

WEDGE-TITE® COUPLER - 6" BODY LENGTH

IPS			Nominal	
Part No.	Price	Size	Part No.	Price
P9025-01		4"	P9025-04	
P9026-01		5"	P9026-05	
P9027-01		6"	P9027-05	
P9028-01		8"	P9028-05	
P9029-01		10"	P9029-05	
P9030-01		12"	P9030-05	



FOR MORE BOLTED COUPLERS SEE SECTION 4

INTRO | 1. ELECTRICAL | 2. PUMP Acc. | 3. HOSE, PE PIPE & Acc. | 4. IPS, PIP Pipe & Acc. | 5. SURFACE | 6. SPRINKLERS | 7. TRAVELER & WHEEL MOVE | 8. PIVOT | 9. TURF | 10. LOW VOLUME | 11. FILTERS | 12. INJECTION | 13. HARDWARE | INDEX

DISCHARGE ADAPTERS

THREADED DISCHARGE ADAPTERS

RING LOCK DISCHARGE ADAPTER - GALVANIZED MIPT X FEMALE

Part No.	Size	Weight Lbs.	Price
SRLDA306	3" x 6"	8	
SRLDA404	4" x 4"	7	
SRLDA405	4" x 5"	8	
SRLDA406	4" x 6"	10	
SRLDA505	5" x 5"	9	
SRLDA506	5" x 6"	10	
SRLDA508	5" x 8"	14	
SRLDA606	6" x 6"	15	
SRLDA608	6" x 8"	16	
SRLDA610	6" x 10"	20	
SRLDA808	8" x 8"	17	
SRLDA810	8" x 10"	22	

FIPT also available



BAND & LATCH DISCHARGE ADAPTER - GALVANIZED MIPT X FEMALE

Part No.	Size	Weight Lbs.	Price
BLSDA202	2" x 2"	2	
BLSDA203	2" x 3"	3	
BLSDA303	3" x 3"	4	
BLSDA304	3" x 4"	5	
BLSDA404	4" x 4"	6	
BLSDA405	4" x 5"	7	
BLSDA406	4" x 6"	9	
BLSDA407	4" x 7"	11	
BLSDA505	5" x 5"	7	
BLSDA506	5" x 6"	9	
BLSDA507	5" x 7"	12	
BLSDA508	5" x 8"	14	
BLSDA606	6" x 6"	15	
BLSDA607	6" x 7"	16	
BLSDA608	6" x 8"	17	



BAND & LATCH DISCHARGE ADAPTER - ALUMINUM MIPT X FEMALE

Part No.	Size	Price	Part No.	Size	Price
DA1502	1-1/2" x 2"		DA3005	3" x 5"	
DA2002	2" x 2"		DA4005	4" x 5"	
DA1503	1-1/2" x 3"		DA3006	3" x 6"	
DA2003	2" x 3"		DA4006	4" x 6"	
DA3003	3" x 3"		DA5006	5" x 6"	
DA1504	1-1/2" x 4"		DA6006	6" x 6"	
DA2004	2" x 4"		DA6007	6" x 7"	
DA3004	3" x 4"		DA6008	6" x 8"	
DA4004	4" x 4"		DA8008	8" x 8"	



FLANGED DISCHARGE ADAPTERS

FLANGE X FEMALE RING LOCK DISCHARGE ADAPTERS

Part No.	Description	Price
RLSDA-FLG-404	4" Flange x 4" Female Ring Lock	
RLSDA-FLG-406	4" Flange x 6" Female Ring Lock	
RLSDA-FLG-408	4" Flange x 8" Female Ring Lock	
RLSDA-FLG-604	6" Flange x 4" Female Ring Lock	
RLSDA-FLG-606	6" Flange x 6" Female Ring Lock	
RLSDA-FLG-608	6" Flange x 8" Female Ring Lock	
RLSDA-FLG-804	8" Flange x 4" Female Ring Lock	
RLSDA-FLG-806	8" Flange x 6" Female Ring Lock	
RLSDA-FLG-808	8" Flange x 8" Female Ring Lock	



FLANGED DISCHARGE ADAPTERS

FLANGE X MALE RING LOCK DISCHARGE ADAPTERS

Part No.	Description	Price
RLSDA-FLG-M-404	4" Flange x 4" Male Ring Lock	
RLSDA-FLG-M-406	4" Flange x 6" Male Ring Lock	
RLSDA-FLG-M-408	4" Flange x 8" Male Ring Lock	
RLSDA-FLG-M-604	6" Flange x 4" Male Ring Lock	
RLSDA-FLG-M-606	6" Flange x 6" Male Ring Lock	
RLSDA-FLG-M-608	6" Flange x 8" Male Ring Lock	
RLSDA-FLG-M-804	8" Flange x 4" Male Ring Lock	
RLSDA-FLG-M-806	8" Flange x 6" Male Ring Lock	
RLSDA-FLG-M-808	8" Flange x 8" Male Ring Lock	



FLANGE X FEMALE BAND & LATCH DISCHARGE ADAPTERS

Part No.	Description	Price
BLSDA-FL-404	4" Flange x 4" Female Band & Latch	
BLSDA-FL-406	4" Flange x 6" Female Band & Latch	
BLSDA-FL-408	4" Flange x 8" Female Band & Latch	
BLSDA-FL-604	6" Flange x 4" Female Band & Latch	
BLSDA-FL-606	6" Flange x 6" Female Band & Latch	
BLSDA-FL-608	6" Flange x 8" Female Band & Latch	
BLSDA-FL-804	8" Flange x 4" Female Band & Latch	
BLSDA-FL-806	8" Flange x 6" Female Band & Latch	
BLSDA-FL-808	8" Flange x 8" Female Band & Latch	



FLANGE X FEMALE TWIST LOCK DISCHARGE ADAPTERS

Part No.	Description	Price
TLSDA-FLG-404	4" Flange x 4" Female Twist Lock	
TLSDA-FLG-406	4" Flange x 6" Female Twist Lock	
TLSDA-FLG-606	6" Flange x 6" Female Twist Lock	



FLANGE X MALE TWIST LOCK DISCHARGE ADAPTERS

Part No.	Description	Price
SFLMTLG-604	6" Flange x 4" Male Twist Lock	
SFLMTLG-606	6" Flange x 6" Male Twist Lock	



FLANGE X MIPT DISCHARGE ADAPTERS

Part No.	Description	Price
SDA-FLG-402	4" Flange x 2" MIPT	
SDA-FLG-403	4" Flange x 3" MIPT	
SDA-FLG-603	6" Flange x 3" MIPT	
SDA-FLG-404	4" Flange x 4" MIPT	
SDA-FLG-604	6" Flange x 4" MIPT	
SDA-FLG-804	8" Flange x 4" MIPT	
SDA-FLG-605	6" Flange x 5" MIPT	
SDA-FLG-606	6" Flange x 6" MIPT	
SDA-FLG-806	8" Flange x 6" MIPT	



FLANGE X FIPT DISCHARGE ADAPTERS

Part No.	Description	Price
SDA-FLG-F-404	4" Flange x 4" FIPT	
SDA-FLG-F-604	6" Flange x 4" FIPT	
SDA-FLG-F-606	6" Flange x 6" FIPT	



INTRO
1. ELECTRICAL
2. PUMP ACC.
3. HOSE, PE PIPE & ACC.
4. IPS, PIP PIPE & ACC.
5. SURFACE
6. SPRINKLERS
7. TRAVELER & WHEEL MOVE
8. PIVOT
9. TURF
10. LOW VOLUME
11. FILTERS
12. INJECTION
13. HARDWARE
INDEX

FLANGED GALVANIZED FITTINGS

FLANGED 45° ELBOW

Part No.	Description	Price
SGFE-400-45	4" 45° Flanged Elbow	
SGFE-500-45	5" 45° Flanged Elbow	
SGFE-600-45	6" 45° Flanged Elbow	
SGFE-800-45	8" 45° Flanged Elbow	
SGFE-1000-45	10" 45° Flanged Elbow	



FLANGED 90° ELBOW

Part No.	Description	Price
SGFE-400	4" 90° Flanged Elbow	
SGFE-500	5" 90° Flanged Elbow	
SGFE-600	6" 90° Flanged Elbow	
SGFE-800	8" 90° Flanged Elbow	
SGFE-1000	10" 90° Flanged Elbow	



FLANGED CROSS

Part No.	Description	Price
SGC FLG 4444	4" x 4" x 4" x 4" Flanged Cross	
SGC FLG 6666	6" x 6" x 6" x 6" Flanged Cross	
SGC FLG 8888	8" x 8" x 8" x 8" Flanged Cross	
SGC FLG 10101010	10" x 10" x 10" x 10" Flanged Cross	



FLANGED TEE

Part No.	Description	Price
SGFT-444	4" x 4" x 4" Flanged Tee	
SGFT-666	6" x 6" x 6" Flanged Tee	
SGFT-888	8" x 8" x 8" Flanged Tee	
SGFT-101010	10" x 10" x 10" Flanged Tee	



FLANGED CONCENTRIC REDUCER

Part No.	Description	Price
SGFR-603	6" Flange x 3" Flange Reducer	
SGFR-604	6" Flange x 4" Flange Reducer	
SGFR-806	8" Flange x 6" Flange Reducer	
SGFR-1006	10" Flange x 6" Flange Reducer	



TEE

Size	Galvanized	Price	Black	Price
1/8"	ZMGT00		ZMBT00	
1/4"	ZMGT01		ZMBT01	
3/8"	ZMGT02		ZMBT02	
1/2"	ZMGT03		ZMBT03	
3/4"	ZMGT04		ZMBT04	
1"	ZMGT05		ZMBT05	
1-1/4"	ZMGT06		ZMBT06	
1-1/2"	ZMGT07		ZMBT07	
2"	ZMGT08		ZMBT08	
2-1/2"	ZMGT09		ZMBT09	
3"	ZMGT10		ZMBT10	
4"	ZMGT11		ZMBT11	
5"	ZMGT12		ZMBT12	
6"	ZMGT13		ZMBT13	



REDUCING TEE (REDUCE 2 SIZES)

Size	Galvanized	Price	Black	Price
3/4" x 1/2"	ZMGTR0403		ZMBTR0403	
1" x 3/4"	ZMGTR0504		ZMBTR0504	
1-1/4" x 1"	ZMGTR0605		ZMBTR0605	
1-1/2" x 1"	ZMGTR0705		ZMBTR0705	
1-1/2" x 1-1/4"	ZMGTR0706		ZMBTR0706	
2" x 1"	ZMGTR0805		ZMBTR0805	
2" x 1-1/4"	ZMGTR0806		ZMBTR0806	
2" x 1-1/2"	ZMGTR0807		ZMBTR0807	

Additional Sizes Available Upon Request



45° ELBOW

Size	Galvanized	Price	Black	Price
1/8"	ZMGL4500		ZMBL4500	
1/4"	ZMGL4501		ZMBL4501	
3/8"	ZMGL4502		ZMBL4502	
1/2"	ZMGL4503		ZMBL4503	
3/4"	ZMGL4504		ZMBL4504	
1"	ZMGL4505		ZMBL4505	
1-1/4"	ZMGL4506		ZMBL4506	
1-1/2"	ZMGL4507		ZMBL4507	
2"	ZMGL4508		ZMBL4508	
2-1/2"	ZMGL4509		ZMBL4509	
3"	ZMGL4510		ZMBL4510	
4"	ZMGL4511		ZMBL4511	
5"	ZMGL4512		ZMBL4512	
6"	ZMGL4513		ZMBL4513	



45° STREET ELBOW

Size	Galvanized	Price	Black	Price
1/8"	ZMGLST4500		ZMBLST4500	
1/4"	ZMGLST4501		ZMBLST4501	
3/8"	ZMGLST4502		ZMBLST4502	
1/2"	ZMGLST4503		ZMBLST4503	
3/4"	ZMGLST4504		ZMBLST4504	
1"	ZMGLST4505		ZMBLST4505	
1-1/4"	ZMGLST4506		ZMBLST4506	
1-1/2"	ZMGLST4507		ZMBLST4507	
2"	ZMGLST4508		ZMBLST4508	
2-1/2"	ZMGLST4509		ZMBLST4509	
3"	ZMGLST4510		ZMBLST4510	
4"	ZMGLST4511		ZMBLST4511	



90° ELBOW

Size	Galvanized	Price	Black	Price
1/8"	ZMGL9000		ZMBL9000	
1/4"	ZMGL9001		ZMBL9001	
3/8"	ZMGL9002		ZMBL9002	
1/2"	ZMGL9003		ZMBL9003	
3/4"	ZMGL9004		ZMBL9004	
1"	ZMGL9005		ZMBL9005	
1-1/4"	ZMGL9006		ZMBL9006	
1-1/2"	ZMGL9007		ZMBL9007	
2"	ZMGL9008		ZMBL9008	
2-1/2"	ZMGL9009		ZMBL9009	
3"	ZMGL9010		ZMBL9010	
4"	ZMGL9011		ZMBL9011	
5"	ZMGL9012		ZMBL9012	
6"	ZMGL9013		ZMBL9013	



90° STREET ELBOW

Size	Galvanized	Price	Black	Price
1/8"	ZMGLST9000		ZMBLST9000	
1/4"	ZMGLST9001		ZMBLST9001	
3/8"	ZMGLST9002		ZMBLST9002	
1/2"	ZMGLST9003		ZMBLST9003	
3/4"	ZMGLST9004		ZMBLST9004	
1"	ZMGLST9005		ZMBLST9005	
1-1/4"	ZMGLST9006		ZMBLST9006	
1-1/2"	ZMGLST9007		ZMBLST9007	
2"	ZMGLST9008		ZMBLST9008	
2-1/2"	ZMGLST9009		ZMBLST9009	
3"	ZMGLST9010		ZMBLST9010	
4"	ZMGLST9011		ZMBLST9011	
6"	MGLST9013		MBLST9013	



REDUCING 90° ELBOW

Size	Galvanized	Price	Black	Price
1" x 3/4"	ZMGLR0504		ZMBLR0504	
1-1/4" x 1"	ZMGLR0605		ZMBLR0605	
1-1/2" x 1-1/4"	ZMGLR0706		ZMBLR0706	
2" x 3/4"	ZMGLR0804		ZMBLR0804	
2" x 1"	ZMGLR0805		ZMBLR0805	
2" x 1-1/4"	ZMGLR0806		ZMBLR0806	
2" x 1-1/2"	ZMGLR0807		ZMBLR0807	

Additional Sizes Available Upon Request



CROSS

Size	Galvanized	Price	Black	Price
1/8"	MGCR00		MBCR00	
1/4"	ZMGCR01		ZMBCR01	
3/8"	ZMGCR02		ZMBCR02	
1/2"	ZMGCR03		ZMBCR03	
3/4"	ZMGCR04		ZMBCR04	
1"	ZMGCR05		ZMBCR05	
1-1/4"	ZMGCR06		ZMBCR06	
1-1/2"	ZMGCR07		ZMBCR07	
2"	ZMGCR08		ZMBCR08	
2-1/2"	ZMGCR09		ZMBCR09	
3"	ZMGCR10		ZMBCR10	
4"	ZMGCR11		ZMBCR11	

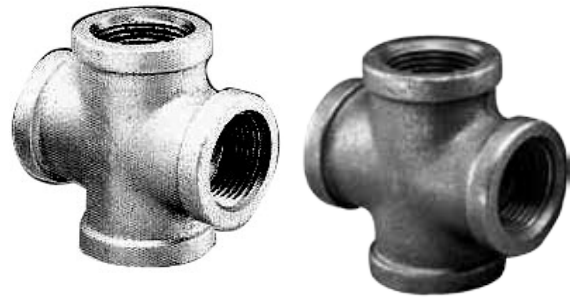

BANDED COUPLING

Size	Galvanized	Price	Black	Price
1/8"	ZMGCP00		ZMBCP00	
1/4"	ZMGCP01		ZMBCP01	
3/8"	ZMGCP02		ZMBCP02	
1/2"	ZMGCP03		ZMBCP03	
3/4"	ZMGCP04		ZMBCP04	
1"	ZMGCP05		ZMBCP05	
1-1/4"	ZMGCP06		ZMBCP06	
1-1/2"	ZMGCP07		ZMBCP07	
2"	ZMGCP08		ZMBCP08	
2-1/2"	ZMGCP09		ZMBCP09	
3"	ZMGCP10		ZMBCP10	
4"	ZMGCP11		ZMBCP11	
5"	ZMGCP12		ZMBCP12	
6"	ZMGCP13		ZMBCP13	

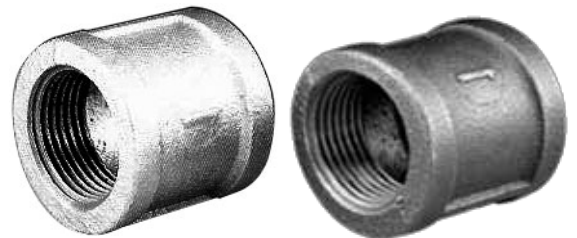

INTRO
 1. ELECTRICAL
 2. PUMP ACC.
 3. HOSE, PE PIPE & ACC.
 4. IPS, PIP PIPE & ACC.
 5. SURFACE
 6. SPRINKLERS
 7. TRAVELER & WHEEL MOVE
 8. PIVOT
 9. TURN
 10. LOW VOLUME
 11. FILTERS
 12. INJECTION
 13. HARDWARE
 INDEX

REDUCER COUPLING

Size	Galvanized	Price	Black	Price
1/4" x 1/8"	ZMGCPR0100		ZMBCPR0100	
3/8" x 1/8"	ZMGCPR0200		ZMBCPR0200	
3/8" x 1/4"	ZMGCPR0201		ZMBCPR0201	
1/2" x 1/8"	ZMGCPR0300		ZMBCPR0300	
1/2" x 1/4"	ZMGCPR0301		ZMBCPR0301	
1/2" x 3/8"	ZMGCPR0302		ZMBCPR0302	
3/4" x 1/8"	ZMGCPR0400		ZMBCPR0400	
3/4" x 1/4"	ZMGCPR0401		ZMBCPR0401	
3/4" x 3/8"	ZMGCPR0402		ZMBCPR0402	
3/4" x 1/2"	ZMGCPR0403		ZMBCPR0403	
1" x 1/4"	ZMGCPR0501		ZMBCPR0501	
1" x 3/8"	ZMGCPR0502		ZMBCPR0502	
1" x 1/2"	ZMGCPR0503		ZMBCPR0503	
1" x 3/4"	ZMGCPR0504		ZMBCPR0504	
1-1/4" x 3/8"	MGCPR0602		MBCPR0602	
1-1/4" x 1/2"	ZMGCPR0603		ZMBCPR0603	
1-1/4" x 3/4"	ZMGCPR0604		ZMBCPR0604	
1-1/4" x 1"	ZMGCPR0605		ZMBCPR0605	
1-1/2" x 3/8"	MGCPR0702		MBCPR0702	
1-1/2" x 1/2"	ZMGCPR0703		ZMBCPR0703	
1-1/2" x 3/4"	ZMGCPR0704		ZMBCPR0704	
1-1/2" x 1"	ZMGCPR0705		ZMBCPR0705	
1-1/2" x 1-1/4"	ZMGCPR0706		ZMBCPR0706	
2" x 3/8"	MGCPR0802		MBCPR0802	
2" x 1/2"	ZMGCPR0803		ZMBCPR0803	
2" x 3/4"	ZMGCPR0804		ZMBCPR0804	
2" x 1"	ZMGCPR0805		ZMBCPR0805	
2" x 1-1/4"	ZMGCPR0806		ZMBCPR0806	
2" x 1-1/2"	ZMGCPR0807		ZMBCPR0807	
2-1/2" x 1/2"	MGCPR0903		ZMBCPR0903	
2-1/2" x 3/4"	MGCPR0904		ZMBCPR0904	
2-1/2" x 1"	MGCPR0905		ZMBCPR0905	
2-1/2" x 1-1/4"	ZMGCPR0906		ZMBCPR0906	
2-1/2" x 1-1/2"	ZMGCPR0907		ZMBCPR0907	
2-1/2" x 2"	ZMGCPR0908		ZMBCPR0908	
3" x 3/4"	MGCPR1004		MBCPR1004	
3" x 1"	ZMGCPR1005		ZMBCPR1005	
3" x 1-1/4"	ZMGCPR1006		ZMBCPR1006	
3" x 1-1/2"	ZMGCPR1007		ZMBCPR1007	
3" x 2"	ZMGCPR1008		ZMBCPR1008	
3" x 2-1/2"	ZMGCPR1009		ZMBCPR1009	
4" x 1"	MGCPR1105		MBCPR1105	
4" x 1-1/4"	MGCPR1106		MBCPR1106	
4" x 1-1/2"	ZMGCPR1107		ZMBCPR1107	
4" x 2"	ZMGCPR1108		ZMBCPR1108	
4" x 2-1/2"	ZMGCPR1109		ZMBCPR1109	
4" x 3"	ZMGCPR1110		ZMBCPR1110	
6" x 3"	MGCPR1310		ZMBCPR1310	
6" x 4"	MGCPR1311		ZMBCPR1311	



MALLEABLE FITTINGS

HEX BUSHING

Size	Galvanized	Price	Black	Price
1/4" x 1/8"	ZMGBU0100		ZMBBU0100	
3/8" x 1/8"	ZMGBU0200		ZMBBU0200	
3/8" x 1/4"	ZMGBU0201		ZMBBU0201	
1/2" x 1/8"	ZMGBU0300		ZMBBU0300	
1/2" x 1/4"	ZMGBU0301		ZMBBU0301	
1/2" x 3/8"	ZMGBU0302		ZMBBU0302	
3/4" x 1/8"	ZMGBU0400		ZMBBU0400	
3/4" x 1/4"	ZMGBU0401		ZMBBU0401	
3/4" x 3/8"	ZMGBU0402		ZMBBU0402	
3/4" x 1/2"	ZMGBU0403		ZMBBU0403	
1" x 1/8"	ZMGBU0500		ZMBBU0500	
1" x 1/4"	ZMGBU0501		ZMBBU0501	
1" x 3/8"	ZMGBU0502		ZMBBU0502	
1" x 1/2"	ZMGBU0503		ZMBBU0503	
1" x 3/4"	ZMGBU0504		ZMBBU0504	
1-1/4" x 1/8"	MGBU0600		MBBU0600	
1-1/4" x 1/4"	ZMGBU0601		ZMBBU0601	
1-1/4" x 3/8"	ZMGBU0602		ZMBBU0602	
1-1/4" x 1/2"	ZMGBU0603		ZMBBU0603	
1-1/4" x 3/4"	ZMGBU0604		ZMBBU0604	
1-1/4" x 1"	ZMGBU0605		ZMBBU0605	
1-1/2" x 1/8"	ZMGBU0700		ZMBBU0700	
1-1/2" x 1/4"	ZMGBU0701		ZMBBU0701	
1-1/2" x 3/8"	ZMGBU0702		ZMBBU0702	
1-1/2" x 1/2"	ZMGBU0703		ZMBBU0703	
1-1/2" x 3/4"	ZMGBU0704		ZMBBU0704	
1-1/2" x 1"	ZMGBU0705		ZMBBU0705	
1-1/2" x 1-1/4"	ZMGBU0706		ZMBBU0706	
2" x 1/4"	ZMGBU0801		MBBU0801	
2" x 3/8"	ZMGBU0802		ZMBBU0802	
2" x 1/2"	ZMGBU0803		ZMBBU0803	
2" x 3/4"	ZMGBU0804		ZMBBU0804	
2" x 1"	ZMGBU0805		ZMBBU0805	
2" x 1-1/4"	ZMGBU0806		ZMBBU0806	
2" x 1-1/2"	ZMGBU0807		ZMBBU0807	
2-1/2" x 1/2"	ZMGBU0903		ZMBBU0903	
2-1/2" x 3/4"	ZMGBU0904		ZMBBU0904	
2-1/2" x 1"	ZMGBU0905		ZMBBU0905	
2-1/2" x 1-1/4"	ZMGBU0906		ZMBBU0906	
2-1/2" x 1-1/2"	ZMGBU0907		ZMBBU0907	
2-1/2" x 2"	ZMGBU0908		ZMBBU0908	



Size	Galvanized	Price	Black	Price
3" x 3/4"	MGBU1004		MBBU1004	
3" x 1"	ZMGBU1005		ZMBBU1005	
3" x 1-1/4"	ZMGBU1006		ZMBBU1006	
3" x 1-1/2"	ZMGBU1007		ZMBBU1007	
3" x 2"	ZMGBU1008		ZMBBU1008	
3" x 2-1/2"	ZMGBU1009		ZMBBU1009	
4" x 1"	ZMGBU1105		ZMBBU1105	
4" x 1-1/4"	ZMGBU1106		ZMBBU1106	
4" x 1-1/2"	ZMGBU1107		ZMBBU1107	
4" x 2"	ZMGBU1108		ZMBBU1108	
4" x 2-1/2"	ZMGBU1109		ZMBBU1109	
4" x 3"	ZMGBU1110		ZMBBU1110	
5" x 3"	ZMGBU1210		ZMBBU1210	
5" x 4"	ZMGBU1211		ZMBBU1211	
6" x 2"	ZMGBU1308		ZMBBU1308	
6" x 3"	ZMGBU1310		ZMBBU1310	
6" x 4"	ZMGBU1311		ZMBBU1311	
6" x 5"	ZMGBU1312		ZMBBU1312	

UNION

Size	Galvanized	Price	Black	Price
1/8"	ZMGUN00		ZMBUN00	
1/4"	ZMGUN01		ZMBUN01	
3/8"	ZMGUN02		ZMBUN02	
1/2"	ZMGUN03		ZMBUN03	
3/4"	ZMGUN04		ZMBUN04	
1"	ZMGUN05		ZMBUN05	
1-1/4"	ZMGUN06		ZMBUN06	
1-1/2"	ZMGUN07		ZMBUN07	
2"	ZMGUN08		ZMBUN08	
2-1/2"	ZMGUN09		ZMBUN09	
3"	ZMGUN10		ZMBUN10	
4"	ZMGUN11		ZMBUN11	

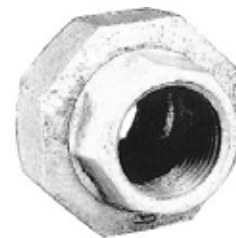

MALLEABLE FITTINGS

SQUARE HEAD PLUG

Size	Galvanized	Price	Black	Price
1/8"	ZMGPL00		ZMBPL00	
1/4"	ZMGPL01		ZMBPL01	
3/8"	ZMGPL02		ZMBPL02	
1/2"	ZMGPL03		ZMBPL03	
3/4"	ZMGPL04		ZMBPL04	
1"	ZMGPL05		ZMBPL05	
1-1/4"	ZMGPL06		ZMBPL06	
1-1/2"	ZMGPL07		ZMBPL07	
2"	ZMGPL08		ZMBPL08	
2-1/2"	ZMGPL09		ZMBPL09	
3"	ZMGPL10		ZMBPL10	
4"	ZMGPL11		ZMBPL11	
5"	ZMGPL12		ZMBPL12	
6"	ZMGPL13		ZMBPL13	



CAP

Size	Galvanized	Price	Black	Price
1/8"	ZMGCA00		ZMBCA00	
1/4"	ZMGCA01		ZMBCA01	
3/8"	ZMGCA02		ZMBCA02	
1/2"	ZMGCA03		ZMBCA03	
3/4"	ZMGCA04		ZMBCA04	
1"	ZMGCA05		ZMBCA05	
1-1/4"	ZMGCA06		ZMBCA06	
1-1/2"	ZMGCA07		ZMBCA07	
2"	ZMGCA08		ZMBCA08	
2-1/2"	ZMGCA09		ZMBCA09	
3"	ZMGCA10		ZMBCA10	
4"	ZMGCA11		ZMBCA11	
5"	MGCA12		ZMBCA12	
6"	ZMGCA13		ZMBCA13	

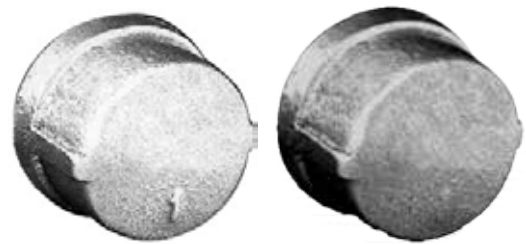

SWAGE NIPPLES



HAMMER UNION



SWAGE FITTINGS

Part No.	Size	Length	Price
44SN4020010	2" x 1"	6.5	
44SN4020012	2" x 1-1/4"	6.5	
44SN4020014	2" x 1-1/2"	6.5	
44SN4024010	2-1/2" x 1"	7.0	
44SN4024014	2-1/2" x 1-1/2"	7.0	
44SN4024020	2-1/2" x 2"	7.0	
44SN4030020	3" x 2"	8.0	
44SN4030024	3" x 2-1/2"	8.0	
44SN4040020	4" x 2"	9.0	
44SN4040024	4" x 2-1/2"	9.0	
44SN4040030	4" x 3"	9.0	
44SN4060030	6" x 3"	12.0	
44SN4060040	6" x 4"	12.0	
44SN4080040	8" x 4"	13.0	
44SN4080060	8" x 6"	13.0	

HAMMER UNION

Part No.	Size	Price
U020100	1" Figure 200 SE	
U021200	1-1/4" Figure 200 SE	
U010200	2" Figure 100 SE	
U010300	3" Figure 100 SE	
U010400	4" Figure 100 SE	

MERCHANT FITTINGS

STANDARD MERCHANT COUPLERS

Size	Galv. Full Part No.	Price	Black Full Part No.	Price	Black Half Part No.	Price
1/8"	M-CG00		M-CB00		M-HCB00	
1/4"	M-CG01		M-CB01		M-HCB01	
3/8"	M-CG02		M-CB02		M-HCB02	
1/2"	M-CG03		M-CB03		M-HCB03	
3/4"	M-CG04		M-CB04		M-HCB04	
1"	M-CG05		M-CB05		M-HCB05	
1-1/4"	M-CG06		M-CB06		M-HCB06	
1-1/2"	M-CG07		M-CB07		M-HCB07	
2"	M-CG08		M-CB08		M-HCB08	
2-1/2"	M-CG09T		M-CB09T		M-HCB09T	
3"	M-CG10T		M-CB10T		M-HCB10T	
4"	M-CG11T		M-CB11T		M-HCB11T	
5"	M-CG12T		M-CB12T		M-HCB12T	
6"	M-CG13T		M-CB13T		M-HCB13T	

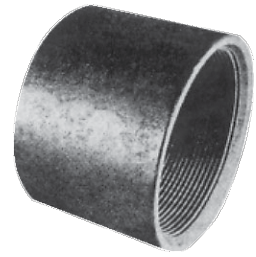

A.P.I. LINE & EXTRA HEAVY RECESSED COUPLINGS

Size	Galvanized Part No.	Price	Black Part No.	Price
8"	M-APIG14		M-APIB14	
10"	M-APIG15		M-APIB15	
12"	M-APIG16		M-APIB16	

MERCHANT SQUARE HEAD PLUG

Size	Galvanized Part No.	Price	Black Part No.	Price
1/8"	M-PG00		M-PB00	
1/4"	M-PG01		M-PB01	
3/8"	M-PG02		M-PB02	
1/2"	M-PG03		M-PB03	
3/4"	M-PG04		M-PB04	



MERCHANT HEX HEAD PLUG

Size	Galvanized Part No.	Price	Black Part No.	Price
1/8"	M-PHHG00		M-PHHB00	
1/4"	M-PHHG01		M-PHHB01	
3/8"	M-PHHG02		M-PHHB02	
1/2"	M-PHHG03		M-PHHB03	
3/4"	M-PHHG04		M-PHHB04	



STEEL PIPE NIPPLES

BLACK STANDARD WELDED TOE STEEL PIPE NIPPLE

Part No.	Size	Length	Price
ZNB083TOE	2"	3"	
ZNB093TOE	2-1/2"	3"	
ZNB103TOE	3"	3"	
ZNB114TOE	4"	4"	
ZNB134TOE	6"	4"	
ZNB146TOE	8"	6"	



BLACK STANDARD WELDED GOE STEEL PIPE NIPPLE

Part No.	Size	Price
GC2	2"	
GC3	3"	
GC4	4"	
GC6	6"	
GC8	8"	
GC10	10"	



STEEL PIPE NIPPLES

GALVANIZED STANDARD WELDED STEEL PIPE NIPPLES - THREADED BOTH ENDS

Length →		Close Part No. Price	2" Part No. Price	4" Part No. Price	6" Part No. Price	8" Part No. Price	10" Part No. Price	12" Part No. Price
Pipe Size ↓	Close Length							
1/8"	3/4"	ZNG00CL	ZNG002	ZNG004	ZNG006	ZNG008	ZNG0010	ZNG0012
1/4"	7/8"	ZNG01CL	ZNG012	ZNG014	ZNG016	ZNG018	ZNG0110	ZNG0112
3/8"	1"	ZNG02CL	ZNG022	ZNG024	ZNG026	ZNG028	ZNG0210	ZNG0212
1/2"	1-1/8"	ZNG03CL	ZNG032	ZNG034	ZNG036	ZNG038	ZNG0310	ZNG0312
3/4"	1-3/8"	ZNG04CL	ZNG042	ZNG044	ZNG046	ZNG048	ZNG0410	ZNG0412
1"	1-1/2"	ZNG05CL	ZNG052	ZNG054	ZNG056	ZNG058	ZNG0510	ZNG0512
1-1/4"	1-5/8"	ZNG06CL	ZNG062	ZNG064	ZNG066	ZNG068	ZNG0610	ZNG0612
1-1/2"	1-3/4"	ZNG07CL	ZNG072	ZNG074	ZNG076	ZNG078	ZNG0710	ZNG0712
2"	2"	ZNG08CL		ZNG084	ZNG086	ZNG088	ZNG0810	ZNG0812
2-1/2"	2-1/2"	ZNG09CL		ZNG094	ZNG096	ZNG098	ZNG0910	ZNG0912
3"	2-5/8"	ZNG10CL		ZNG104	ZNG106	ZNG108	ZNG1010	ZNG1012
4"	2-7/8"	ZNG11CL		ZNG114	ZNG116	ZNG118	ZNG1110	ZNG1112
5"	3"	ZNG12CL		ZNG124	ZNG126	ZNG128	ZNG1210	ZNG1212
6"	3-1/8"	ZNG13CL		ZNG134	ZNG136	ZNG138	ZNG1310	ZNG1312



GALVANIZED PRE-CUT STEEL PIPE - THREADED BOTH ENDS

Length →	18"	24"	30"	36"	48"	60"	72"	120"
Pipe Size ↓	Part No. Price	Part No. Price	Part No. Price	Part No. Price	Part No. Price	Part No. Price	Part No. Price	Part No. Price
1/4"	NG0118	NG0124	NG0130	NG0136	NG0148	NG0160	NG0172	NG01120
3/8"	NG0218	NG0224	NG0230	NG0236	NG0248	NG0260	NG0272	NG02120
1/2"	NG0318	NG0324	NG0330	NG0336	NG0348	NG0360	NG0372	NG03120
3/4"	NG0418	NG0424	NG0430	NG0436	NG0448	NG0460	NG0472	NG04120
1"	NG0518	NG0524	NG0530	NG0536	NG0548	NG0560	NG0572	NG05120
1-1/4"	NG0618	NG0624	NG0630	NG0636	NG0648	NG0660	NG0672	NG06120
1-1/2"	NG0718	NG0724	NG0730	NG0736	NG0748	NG0760	NG0772	NG07120
2"	NG0818	NG0824	NG0830	NG0836	NG0848	NG0860	NG0872	NG08120
2-1/2"	NG0918	NG0924	NG0930	NG0936	NG0948	NG0960	NG0972	NG09120
3"	NG1018	NG1024	NG1030	NG1036	NG1048	NG1060	NG1072	NG10120
4"	NG1118	NG1124	NG1130	NG1136	NG1148	NG1160	NG1172	NG11120

STEEL PIPE NIPPLES

BLACK STANDARD WELDED STEEL PIPE NIPPLES - THREADED BOTH ENDS

Length →		Close Part No. Price	2" Part No. Price	4" Part No. Price	6" Part No. Price	8" Part No. Price	10" Part No. Price	12" Part No. Price
Pipe Size ↓	Close Length							
1/8"	3/4"	ZNB00CL	ZNB002	ZNB004	ZNB006	ZNB008	ZNB0010	ZNB0012
1/4"	7/8"	ZNB01CL	ZNB012	ZNB014	ZNB016	ZNB018	ZNB0110	ZNB0112
3/8"	1"	ZNB02CL	ZNB022	ZNB024	ZNB026	ZNB028	ZNB0210	ZNB0212
1/2"	1-1/8"	ZNB03CL	ZNB032	ZNB034	ZNB036	ZNB038	ZNB0310	ZNB0312
3/4"	1-3/8"	ZNB04CL	ZNB042	ZNB044	ZNB046	ZNB048	ZNB0410	ZNB0412
1"	1-1/2"	ZNB05CL	ZNB052	ZNB054	ZNB056	ZNB058	ZNB0510	ZNB0512
1-1/4"	1-5/8"	ZNB06CL	ZNB062	ZNB064	ZNB066	ZNB068	ZNB0610	ZNB0612
1-1/2"	1-3/4"	ZNB07CL	ZNB072	ZNB074	ZNB076	ZNB078	ZNB0710	ZNB0712
2"	2"	ZNB08CL		ZNB084	ZNB086	ZNB088	ZNB0810	ZNB0812
2-1/2"	2-1/2"	ZNB09CL		ZNB094	ZNB096	ZNB098	ZNB0910	ZNB0912
3"	2-5/8"	ZNB10CL		ZNB104	ZNB106	ZNB108	ZNB1010	ZNB1012
4"	2-7/8"	ZNB11CL		ZNB114	ZNB116	ZNB118	ZNB1110	ZNB1112
5"	3"	ZNB12CL		ZNB124	ZNB126	ZNB128	ZNB1210	ZNB1212
6"	3-1/8"	ZNB13CL		ZNB134	ZNB136	ZNB138	ZNB1310	ZNB1312



BLACK PRE-CUT STEEL PIPE - THREADED BOTH ENDS

Length →	18"	24"	30"	36"	48"	60"	72"	120"
Pipe Size ↓	Part No. Price	Part No. Price	Part No. Price	Part No. Price	Part No. Price	Part No. Price	Part No. Price	Part No. Price
1/4"	NB0118	NB0124	NB0130	NB0136	NB0148	NB0160	NB0172	NB01120
3/8"	NB0218	NB0224	NB0230	NB0236	NB0248	NB0260	NB0272	NB02120
1/2"	NB0318	NB0324	NB0330	NB0336	NB0348	NB0360	NB0372	NB03120
3/4"	NB0418	NB0424	NB0430	NB0436	NB0448	NB0460	NB0472	NB04120
1"	NB0518	NB0524	NB0530	NB0536	NB0548	NB0560	NB0572	NB05120
1-1/4"	NB0618	NB0624	NB0630	NB0636	NB0648	NB0660	NB0672	NB06120
1-1/2"	NB0718	NB0724	NB0730	NB0736	NB0748	NB0760	NB0772	NB07120
2"	NB0818	NB0824	NB0830	NB0836	NB0848	NB0860	NB0872	NB08120
2-1/2"	NB0918	NB0924	NB0930	NB0936	NB0948	NB0960	NB0972	NB09120
3"	NB1018	NB1024	NB1030	NB1036	NB1048	NB1060	NB1072	NB10120
4"	NB1118	NB1124	NB1130	NB1136	NB1148	NB1160	NB1172	NB11120

INTRO
 1. ELECTRICAL
 2. PUMP Acc.
 3. HOSE, PE PIPE & Acc.
 4. IPS, PIP Pipe & Acc.
 5. SURFACE
 6. SPRINKLERS
 7. TRAVELER & WHEEL MOVE
 8. PIVOT
 9. TURN
 10. LOW VOLUME
 11. FILTERS
 12. INJECTION
 13. HARDWARE
 INDEX

TEE

Size	Type 304 Threaded		Type 316 Threaded	
	Part No.	Price	Part No.	Price
1/8"	S3014T 001		S3016T 001	
1/4"	S3014T 002		S3016T 002	
3/8"	S3014T 003		S3016T 003	
1/2"	S3014T 004		S3016T 004	
3/4"	S3014T 006		S3016T 006	
1"	S3014T 010		S3016T 010	
1-1/4"	S3014T 012		S3016T 012	
1-1/2"	S3014T 014		S3016T 014	
2"	S3014T 020		S3016T 020	
2-1/2"	S3014T 024		S3016T 024	
3"	S3014T 030		S3016T 030	
4"	S3014T 040		S3016T 040	



45° ELBOW

Size	Type 304 Threaded		Type 316 Threaded	
	Part No.	Price	Part No.	Price
1/8"	S3014F 001		S3016F 001	
1/4"	S3014F 002		S3016F 002	
3/8"	S3014F 003		S3016F 003	
1/2"	S3014F 004		S3016F 004	
3/4"	S3014F 006		S3016F 006	
1"	S3014F 010		S3016F 010	
1-1/4"	S3014F 012		S3016F 012	
1-1/2"	S3014F 014		S3016F 014	
2"	S3014F 020		S3016F 020	
2-1/2"	S3014F 024		S3016F 024	
3"	S3014F 030		S3016F 030	
4"	S3014F 040		S3016F 040	



90° ELBOW

Size	Type 304 Threaded		Type 316 Threaded	
	Part No.	Price	Part No.	Price
1/8"	S3014E 001		S3016E 001	
1/4"	S3014E 002		S3016E 002	
3/8"	S3014E 003		S3016E 003	
1/2"	S3014E 004		S3016E 004	
3/4"	S3014E 006		S3016E 006	
1"	S3014E 010		S3016E 010	
1-1/4"	S3014E 012		S3016E 012	
1-1/2"	S3014E 014		S3016E 014	
2"	S3014E 020		S3016E 020	
2-1/2"	S3014E 024		S3016E 024	
3"	S3014E 030		S3016E 030	
4"	S3014E 040		S3016E 040	



90° STREET ELBOW

Size	Type 304 Threaded		Type 316 Threaded	
	Part No.	Price	Part No.	Price
1/8"	S3014SE001		S3016SE001	
1/4"	S3014SE002		S3016SE002	
3/8"	S3014SE003		S3016SE003	
1/2"	S3014SE004		S3016SE004	
3/4"	S3014SE006		S3016SE006	
1"	S3014SE010		S3016SE010	
1-1/4"	S3014SE012		S3016SE012	
1-1/2"	S3014SE014		S3016SE014	
2"	S3014SE020		S3016SE020	
2-1/2"	S3014SE024		S3016SE024	
3"	S3014SE030		S3016SE030	
4"	S3014SE040		S3016SE040	



CROSS

Size	Type 304 Threaded		Type 316 Threaded	
	Part No.	Price	Part No.	Price
1/8"	S3014X001		S3016X001	
1/4"	S3014X002		S3016X002	
3/8"	S3014X003		S3016X003	
1/2"	S3014X004		S3016X004	
3/4"	S3014X006		S3016X006	
1"	S3014X010		S3016X010	
1-1/4"	S3014X012		S3016X012	
1-1/2"	S3014X014		S3016X014	
2"	S3014X020		S3016X020	
2-1/2"	S3014X024		S3016X024	
3"	S3014X030		S3016X030	
4"	S3014X040		S3016X040	



HALF COUPLING

Size	Type 304 Threaded		Type 316 Threaded	
	Part No.	Price	Part No.	Price
1/8"	S3014HC001		S3016HC001	
1/4"	S3014HC002		S3016HC002	
3/8"	S3014HC003		S3016HC003	
1/2"	S3014HC004		S3016HC004	
3/4"	S3014HC006		S3016HC006	
1"	S3014HC010		S3016HC010	
1-1/4"	S3014HC012		S3016HC012	
1-1/2"	S3014HC014		S3016HC014	
2"	S3014HC020		S3016HC020	
2-1/2"	S3014HC024		S3016HC024	
3"	S3014HC030		S3016HC030	
4"	S3014HC040		S3016HC040	



INTRO
 1. ELECTRICAL
 2. PUMP ACC.
 3. HOSE, PE PIPE & ACC.
 4. IPS, PIP PIPE & ACC.
 5. SURFACE
 6. SPRINKLERS
 7. TRAVELER & WHEEL MOVE
 8. PIVOT
 9. TURN
 10. LOW VOLUME
 11. FILTERS
 12. INJECTION
 13. HARDWARE
 INDEX

FULL COUPLING

Size	Type 304 Threaded		Type 316 Threaded	
	Part No.	Price	Part No.	Price
1/8"	S3014CP001		S3016CP001	
1/4"	S3014CP002		S3016CP002	
3/8"	S3014CP003		S3016CP003	
1/2"	S3014CP004		S3016CP004	
3/4"	S3014CP006		S3016CP006	
1"	S3014CP010		S3016CP010	
1-1/4"	S3014CP012		S3016CP012	
1-1/2"	S3014CP014		S3016CP014	
2"	S3014CP020		S3016CP020	
2-1/2"	S3014CP024		S3016CP024	
3"	S3014CP030		S3016CP030	
4"	S3014CP040		S3016CP040	



REDUCING COUPLING

Size	Type 304 Threaded		Type 316 Threaded	
	Part No.	Price	Part No.	Price
1/4" x 1/8"	S3014RC002001		S3016RC002001	
3/8" x 1/8"	S3014RC003001		S3016RC003001	
3/8" x 1/4"	S3014RC003002		S3016RC003002	
1/2" x 1/8"	S3014RC004001		S3016RC004001	
1/2" x 1/4"	S3014RC004002		S3016RC004002	
1/2" x 3/8"	S3014RC004003		S3016RC004003	
3/4" x 1/8"	S3014RC006001		S3016RC006001	
3/4" x 1/4"	S3014RC006002		S3016RC006002	
3/4" x 3/8"	S3014RC006003		S3016RC006003	
3/4" x 1/2"	S3014RC006004		S3016RC006004	
1" x 1/8"	S3014RC010001		S3016RC010001	
1" x 1/4"	S3014RC010002		S3016RC010002	
1" x 3/8"	S3014RC010003		S3016RC010003	
1" x 1/2"	S3014RC010004		S3016RC010004	
1" x 3/4"	S3014RC010006		S3016RC010006	
1-1/4" x 1/4"	S3014RC012002		S3016RC012002	
1-1/4" x 3/8"	S3014RC012003		S3016RC012003	
1-1/4" x 1/2"	S3014RC012004		S3016RC012004	
1-1/4" x 3/4"	S3014RC012006		S3016RC012006	
1-1/4" x 1"	S3014RC012010		S3016RC012010	
1-1/2" x 1/4"	S3014RC014002		S3016RC014002	
1-1/2" x 3/8"	S3014RC014003		S3016RC014003	
1-1/2" x 1/2"	S3014RC014004		S3016RC014004	
1-1/2" x 3/4"	S3014RC014006		S3016RC014006	
1-1/2" x 1"	S3014RC014010		S3016RC014010	
1-1/2" x 1-1/4"	S3014RC014012		S3016RC014012	
2" x 1/4"	S3014RC020002		S3016RC020002	
2" x 3/8"	S3014RC020003		S3016RC020003	
2" x 1/2"	S3014RC020004		S3016RC020004	
2" x 3/4"	S3014RC020006		S3016RC020006	
2" x 1"	S3014RC020010		S3016RC020010	
2" x 1-1/4"	S3014RC020012		S3016RC020012	
2" x 1-1/2"	S3014RC020014		S3016RC020014	
2-1/2" x 1"	S3014RC024010		S3016RC024010	
2-1/2" x 1-1/4"	S3014RC024012		S3016RC024012	
2-1/2" x 1-1/2"	S3014RC024014		S3016RC024014	
2-1/2" x 2"	S3014RC024020		S3016RC024020	
3" x 3/4"	S3014RC030006		S3016RC030006	
3" x 1"	S3014RC030010		S3016RC030010	



Continued on next page

REDUCING COUPLING - CONTINUED

Size	Type 304 Threaded		Type 316 Threaded	
	Part No.	Price	Part No.	Price
3" x 1-1/4"	S3014RC030012		S3016RC030012	
3" x 1-1/2"	S3014RC030014		S3016RC030014	
3" x 2"	S3014RC030020		S3016RC030020	
3" x 2-1/2"	S3014RC030024		S3016RC030024	
4" x 1"	S3014RC040010		S3016RC040010	
4" x 1-1/2"	S3014RC040014		S3016RC040014	
4" x 2"	S3014RC040020		S3016RC040020	



HEX BUSHING

Size	Type 304 Threaded		Type 316 Threaded	
	Part No.	Price	Part No.	Price
1/4" x 1/8"	S3014HB002001		S3016HB002001	
3/8" x 1/8"	S3014HB003001		S3016HB003001	
3/8" x 1/4"	S3014HB003002		S3016HB003002	
1/2" x 1/8"	S3014HB004001		S3016HB004001	
1/2" x 1/4"	S3014HB004002		S3016HB004002	
1/2" x 3/8"	S3014HB004003		S3016HB004003	
3/4" x 1/8"	S3014HB006001		S3016HB006001	
3/4" x 1/4"	S3014HB006002		S3016HB006002	
3/4" x 3/8"	S3014HB006003		S3016HB006003	
3/4" x 1/2"	S3014HB006004		S3016HB006004	
1" x 1/8"	S3014HB010001		S3016HB010001	
1" x 1/4"	S3014HB010002		S3016HB010002	
1" x 3/8"	S3014HB010003		S3016HB010003	
1" x 1/2"	S3014HB010004		S3016HB010004	
1" x 3/4"	S3014HB010006		S3016HB010006	
1-1/4" x 1/8"	S3014HB012001		S3016HB012001	
1-1/4" x 1/4"	S3014HB012002		S3016HB012002	
1-1/4" x 3/8"	S3014HB012003		S3016HB012003	
1-1/4" x 1/2"	S3014HB012004		S3016HB012004	
1-1/4" x 3/4"	S3014HB012006		S3016HB012006	
1-1/4" x 1"	S3014HB012010		S3016HB012010	
1-1/2" x 1/8"	S3014HB014001		S3016HB014001	
1-1/2" x 1/4"	S3014HB014002		S3016HB014002	
1-1/2" x 3/8"	S3014HB014003		S3016HB014003	
1-1/2" x 1/2"	S3014HB014004		S3016HB014004	
1-1/2" x 3/4"	S3014HB014006		S3016HB014006	
1-1/2" x 1"	S3014HB014010		S3016HB014010	
1-1/2" x 1-1/4"	S3014HB014012		S3016HB014012	
2" x 1/4"	S3014HB020002		S3016HB020002	
2" x 3/8"	S3014HB020003		S3016HB020003	
2" x 1/2"	S3014HB020004		S3016HB020004	
2" x 3/4"	S3014HB020006		S3016HB020006	
2" x 1"	S3014HB020010		S3016HB020010	
2" x 1-1/4"	S3014HB020012		S3016HB020012	
2" x 1-1/2"	S3014HB020014		S3016HB020014	
2-1/2" x 3/4"	S3014HB024006		S3016HB024006	
2-1/2" x 1"	S3014HB024010		S3016HB024010	
2-1/2" x 1-1/4"	S3014HB024012		S3016HB024012	
2-1/2" x 1-1/2"	S3014HB024014		S3016HB024014	
2-1/2" x 2"	S3014HB024020		S3016HB024020	
3" x 1/2"	S3014HB030004		S3016HB030004	
3" x 3/4"	S3014HB030006		S3016HB030006	
3" x 1"	S3014HB030010		S3016HB030010	
3" x 1-1/4"	S3014HB030012		S3016HB030012	
3" x 1-1/2"	S3014HB030014		S3016HB030014	



Continued on next page

- INTRO
- 1. ELECTRICAL
- 2. PUMP Acc.
- 3. HOSE, PE PIPE & Acc.
- 4. IPS, PIP Pipe & Acc.
- 5. SURFACE
- 6. SPRINKLERS
- 7. TRAVELER & WHEEL MOVE
- 8. PIVOT
- 9. TURF
- 10. LOW VOLUME
- 11. FILTERS
- 12. INJECTION
- 13. HARDWARE
- INDEX

STAINLESS STEEL FITTINGS

HEX BUSHING - CONTINUED

Size	Type 304 Threaded		Type 316 Threaded	
	Part No.	Price	Part No.	Price
3" x 2"	S3014HB030020		S3016HB030020	
3" x 2-1/2"	S3014HB030024		S3016HB030024	
4" x 1"	S3014HB040010		S3016HB040010	
4" x 1-1/4"	S3014HB040012		S3016HB040012	
4" x 1-1/2"	S3014HB040014		S3016HB040014	
4" x 2"	S3014HB040020		S3016HB040020	
4" x 2-1/2"	S3014HB040024		S3016HB040024	
4" x 3"	S3014HB040030		S3016HB040030	



UNION

Size	Type 304 Threaded		Type 316 Threaded	
	Part No.	Price	Part No.	Price
1/8"	S3014U001		S3016U001	
1/4"	S3014U002		S3016U002	
3/8"	S3014U003		S3016U003	
1/2"	S3014U004		S3016U004	
3/4"	S3014U006		S3016U006	
1"	S3014U010		S3016U010	
1-1/4"	S3014U012		S3016U012	
1-1/2"	S3014U014		S3016U014	
2"	S3014U020		S3016U020	
2-1/2"	S3014U024		S3016U024	
3"	S3014U030		S3016U030	
4"	S3014U040		S3016U040	



SQUARE HEAD PLUG

Size	Type 304 Threaded		Type 316 Threaded	
	Part No.	Price	Part No.	Price
1/8"	S3014SP001		S3016SP001	
1/4"	S3014SP002		S3016SP002	
3/8"	S3014SP003		S3016SP003	
1/2"	S3014SP004		S3016SP004	
3/4"	S3014SP006		S3016SP006	
1"	S3014SP010		S3016SP010	
1-1/4"	S3014SP012		S3016SP012	
1-1/2"	S3014SP014		S3016SP014	
2"	S3014SP020		S3016SP020	
2-1/2"	S3014SP024		S3016SP024	
3"	S3014SP030		S3016SP030	
4"	S3014SP040		S3016SP040	



CAP

Size	Type 304 Threaded		Type 316 Threaded	
	Part No.	Price	Part No.	Price
1/8"	S3014C001		S3016C001	
1/4"	S3014C002		S3016C002	
3/8"	S3014C003		S3016C003	
1/2"	S3014C004		S3016C004	
3/4"	S3014C006		S3016C006	
1"	S3014C010		S3016C010	
1-1/4"	S3014C012		S3016C012	
1-1/2"	S3014C014		S3016C014	
2"	S3014C020		S3016C020	
2-1/2"	S3014C024		S3016C024	
3"	S3014C030		S3016C030	
4"	S3014C040		S3016C040	



THREADED FLANGE

Size	Type 304 Threaded		Type 316 Threaded	
	Part No.	Price	Part No.	Price
2"	S1014TH020N		S1016TH020N	
2-1/2"	S1014TH024N		S1016TH024N	
3"	S1014TH030N		S1016TH030N	
4"	S1014TH040N		S1016TH040N	
5"	S1014TH050N		S1016TH050N	
6"	S1014TH060N		S1016TH060N	



SLIP-ON IPS 1/2" PLATE FLANGE

Size	Type 304		Type 316	
	Part No.	Price	Part No.	Price
2"	S1414SOP020		S1416SOP020	
2-1/2"	S1414SOP024		S1416SOP024	
3"	S1414SOP030		S1416SOP030	
4"	S1414SOP040		S1416SOP040	
5"	S1414SOP050		S1416SOP050	
6"	S1414SOP060		S1416SOP060	
8"	S1414SOP080		S1416SOP080	



SLIP-ON OD 1/2" PLATE FLANGE

Size	Type 304		Type 316	
	Part No.	Price	Part No.	Price
2"	S1414SOTP020		S1416SOTP020	
2-1/2"	S1414SOTP024		S1416SOTP024	
3"	S1414SOTP030		S1416SOTP030	
4"	S1414SOTP040		S1416SOTP030	
5"	S1414SOTP050		S1416SOTP050	
6"	S1414SOTP060		S1416SOTP060	
8"	S1414SOTP080		S1416SOTP080	



BLIND FLANGE

Size	Type 304 / 304L		Type 316 / 316L	
	Part No.	Price	Part No.	Price
2"	S1014BL020N		S1016BL020N	
2-1/2"	S1014BL024N		S1016BL024N	
3"	S1014BL030N		S1016BL030N	
4"	S1014BL040N		S1016BL040N	
5"	S1014BL050N		S1016BL050N	
6"	S1014BL060N		S1016BL060N	
8"	S1014BL080N		S1016BL080N	



MANY OTHER STAINLESS STEEL FITTINGS ARE AVAILABLE FOR QUOTE BY SPECIAL REQUEST, INCLUDING:

- More 150 LB. threaded fittings including hex head plug, lock nut & welding spud
- 150 LB. barstock threaded fittings
- 3000 LB. threaded fittings
- Seamless nipples
- Flanges: lap joint, slip-on, weldneck & socket weld
- 150 LB. socket weld fittings
- Sch. 10, Sch. 40 & Sch. 80 weld fittings
- Belled end fittings
- Grooved fittings

STAINLESS STEEL PIPE NIPPLES

TYPE 304 / 304L SCH. 40 WELDED STAINLESS PIPE NIPPLES - THREADED BOTH ENDS

Length → Pipe Size ↓	Close Part No. Price	2" Part No. Price	4" Part No. Price	6" Part No. Price	8" Part No. Price	10" Part No. Price	12" Part No. Price
1/8"	S8344NI001006	S8344NI001020	S8344NI001040	S8344NI001060	S8344NI001080	S8344NI001100	S8344NI001120
1/4"	S8344NI002007	S8344NI002020	S8344NI002040	S8344NI002060	S8344NI002080	S8344NI002100	S8344NI002120
3/8"	S8344NI003010	S8344NI003020	S8344NI003040	S8344NI003060	S8344NI003080	S8344NI003100	S8344NI003120
1/2"	S8344NI004011	S8344NI004020	S8344NI004040	S8344NI004060	S8344NI004080	S8344NI004100	S8344NI004120
3/4"	S8344NI006013	S8344NI006020	S8344NI006040	S8344NI006060	S8344NI006080	S8344NI006100	S8344NI006120
1"	S8344NI010014	S8344NI010020	S8344NI010040	S8344NI010060	S8344NI010080	S8344NI010100	S8344NI010120
1-1/4"	S8344NI012015	S8344NI012020	S8344NI012040	S8344NI012060	S8344NI012080	S8344NI012100	S8344NI012120
1-1/2"	S8344NI014016	S8344NI014020	S8344NI014040	S8344NI014060	S8344NI014080	S8344NI014100	S8344NI014120
2"	S8344NI020020		S8344NI020040	S8344NI020060	S8344NI020080	S8344NI020100	S8344NI020120
2-1/2"	S8344NI024024		S8344NI024040	S8344NI024060	S8344NI024080	S8344NI024100	S8344NI024120
3"	S8344NI030025		S8344NI030040	S8344NI030060	S8344NI030080	S8344NI030100	S8344NI030120
4"	S8344NI040027		S8344NI040040	S8344NI040060	S8344NI040080	S8344NI040100	S8344NI040120



TYPE 316 / 316L SCH. 40 WELDED STAINLESS PIPE NIPPLES - THREADED BOTH ENDS

Length → Pipe Size ↓	Close Part No. Price	2" Part No. Price	4" Part No. Price	6" Part No. Price	8" Part No. Price	10" Part No. Price	12" Part No. Price
1/8"	S8346NI001006	S8346NI001020	S8346NI001040	S8346NI001060	S8346NI001080	S8346NI001100	S8346NI001120
1/4"	S8346NI002007	S8346NI002020	S8346NI002040	S8346NI002060	S8346NI002080	S8346NI002100	S8346NI002120
3/8"	S8346NI003010	S8346NI003020	S8346NI003040	S8346NI003060	S8346NI003080	S8346NI003100	S8346NI003120
1/2"	S8346NI004011	S8346NI004020	S8346NI004040	S8346NI004060	S8346NI004080	S8346NI004100	S8346NI004120
3/4"	S8346NI006013	S8346NI006020	S8346NI006040	S8346NI006060	S8346NI006080	S8346NI006100	S8346NI006120
1"	S8346NI010014	S8346NI010020	S8346NI010040	S8346NI010060	S8346NI010080	S8346NI010100	S8346NI010120
1-1/4"	S8346NI012015	S8346NI012020	S8346NI012040	S8346NI012060	S8346NI012080	S8346NI012100	S8346NI012120
1-1/2"	S8346NI014016	S8346NI014020	S8346NI014040	S8346NI014060	S8346NI014080	S8346NI014100	S8346NI014120
2"	S8346NI020020		S8346NI020040	S8346NI020060	S8346NI020080	S8346NI020100	S8346NI020120
2-1/2"	S8346NI024024		S8346NI024040	S8346NI024060	S8346NI024080	S8346NI024100	S8346NI024120
3"	S8346NI030025		S8346NI030040	S8346NI030060	S8346NI030080	S8346NI030100	S8346NI030120
4"	S8346NI040027		S8346NI040040	S8346NI040060	S8346NI040080	S8346NI040100	S8346NI040120



Note: Other lengths are available for quote by special request.

SERVICE SADDLES

BRONZE SADDLE FOR IPS PVC

Part No.	Pipe Size	Pipe OD	Outlet Size	Price
3401-114X3/4NPT	1-1/4"	1.66"	3/4" FPT	
3401-112X3/4NPT	1-1/2"	1.90"	3/4" FPT	
3401-2X1NPT	2"	2.38"	1" FPT	
3401-212X1NPT	2-1/2"	2.88"	1" FPT	
3401-3X2NPT	3"	3.50"	2" FPT	
3401-4X2NPT	4"	4.50"	2" FPT	
3401-5X1NPT	5"	5.56"	1" FPT	
3401-6X2NPT	6"	6.63"	2" FPT	
3401-8X2NPT	8"	8.63"	2" FPT	
3401-10X2NPT	10"	10.75"	2" FPT	
3401-12X2NPT	12"	12.75"	2" FPT	



DUCTILE IRON SADDLE WITH BALE

Part No.	Pipe Size	Pipe OD Range	Outlet Size	Price
3411DI-1X1NPT	1"	1.31 - 1.39	1" FPT	
3411DI-114-112X1NPT	1-1/4" - 1-1/2"	1.61 - 1.92	1" FPT	
3411DI-2X1NPT	2"	2.38	1" FPT	
3411DI-2X112NPT	2"	2.35 - 2.56	1-1/2" FPT	
3411DI-214-212X112NPT	2-1/4" - 2-1/2"	2.44 - 2.91	1-1/2" FPT	
3411DI-3X112NPT	3"	2.97 - 3.54	1-1/2" FPT	
3411DI-3-4X2NPT	3" - 4"	3.74 - 4.55	2" FPT	
3411DI-4-5X2NPT	4" - 5"	4.74 - 5.63	2" FPT	
3411DI-5-6X2NPT	5" - 6"	5.94 - 6.70	2" FPT	
3411DI-6X2NPT	6"	6.84 - 7.60	2" FPT	
3411DI-6-8X2NPT	6" - 8"	7.69 - 8.72	2" FPT	
3411DI-8-10X2NPT	8" - 10"	8.54 - 10.10	2" FPT	
3411DI-10-12X2NPT	10" - 12"	10.64 - 12.12	2" FPT	
3411DI-12-14X2NPT	12" - 14"	12.62 - 14.32	2" FPT	

Not available in the 1-1/2" CC



DUCTILE IRON SADDLE WITH BALES

Part No.	Pipe Size	Pipe OD Range	Outlet Size	Price
3413-2AX112NPT	2"	2.38" - 2.50"	1-1/2" FPT	
3413-3BX2NPT	3"	3.45" - 4.05"	2" FPT	
3413-4AX2NPT	4"	4.00" - 4.50"	2" FPT	
3413-4CX2NPT	4"	4.74" - 5.14"	2" FPT	
3413-6AX2NPT	6"	6.00" - 6.63"	2" FPT	
3413-6BX2NPT	6"	6.84" - 7.64"	2" FPT	
3413-8AX2NPT	8"	8.00" - 8.63"	2" FPT	
3413-8BX2NPT	8"	8.54" - 10.10"	2" FPT	
3413-10AX2NPT	10"	10.00" - 11.10"	2" FPT	
3413-10BX2NPT	10"	10.64" - 12.12"	2" FPT	
3413-12AX2NPT	12"	12.00" - 13.20"	2" FPT	
3413-12BX2NPT	12"	12.62" - 14.32"	2" FPT	
3413-1214AX2NPT	12" - 14"	14.73" - 15.65"	2" FPT	
3413-1618AX2NPT	16" - 18"	17.40" - 18.88"	2" FPT	
3413-18AX2NPT	18"	19.50"	2" FPT	
3413-20AX2NPT	20"	21.60"	2" FPT	
3413-24AX2NPT	24"	25.80"	2" FPT	

**Not to be used on IPS PVC

Other outlet sizes available



INTRO | 1. ELECTRICAL | 2. PUMP ACC. | 3. HOSE, PE PIPE & ACC. | 4. IPS, PIP PIPE & ACC. | 5. SURFACE | 6. SPRINKLERS | 7. TRAVELER & WHEEL MOVE | 8. PIVOT | 9. TURF | 10. LOW VOLUME | 11. FILTERS | 12. INJECTION | 13. HARDWARE | INDEX

45° SUCTION ELBOW - ALUMINUM

Part No.	Size	Weight Lbs.	Price
SFE42	2"	3.5	
SFE43	3"	4.5	
SFE44	4"	6.0	
SFE45	5"	7.0	
SFE46	6"	9.0	
SFE48	8"	12.0	
SFE410	10"	17.0	



90° SUCTION ELBOW - ALUMINUM

Part No.	Size	Weight Lbs.	Price
SFE92	2"	4.0	
SFE93	3"	5.0	
SFE94	4"	7.0	
SFE95	5"	8.5	
SFE96	6"	10.5	
SFE98	8"	14.5	
SFE910	10"	23.0	



INTAKE COUPLERS - ALUMINUM

Part No.	Size	Weight Lbs.	Price
SFC2	2"	2.5	
SFC3	3"	3.0	
SFC4	4"	4.0	
SFC5	5"	5.0	
SFC6	6"	5.5	
SFC8	8"	7.0	
SFC10	10"	9.5	



SUCTION ADAPTER - ALUMINUM

Part No.	Size	Weight Lbs.	Price
SA1503	1-1/2" x 3"	1.5	
SA2003	2" x 3"	2.0	
SA2503	2-1/2" x 3"	2.0	
SA3003	3" x 3"	2.0	
SA2004	2" x 4"	2.5	
SA3004	3" x 4"	2.5	
SA4004	4" x 4"	2.5	
SA3005	3" x 5"	3.0	
SA4005	4" x 5"	3.0	
SA5005	5" x 5"	3.0	
SA3006	3" x 6"	4.0	
SA4006	4" x 6"	4.0	
SA5006	5" x 6"	4.0	
SA6006	6" x 6"	4.0	
SA5007	5" x 7"	4.5	
SA6007	6" x 7"	4.5	
SA7007	7" x 7"	4.5	
SA5008	5" x 8"	5.0	
SA6008	6" x 8"	5.0	
SA7008	7" x 8"	5.25	
SA8008	8" x 8"	5.25	



SUCTION ADAPTER - STEEL

Part No.	Size	Weight Lbs.	Price
SSA3003	3" x 3"	4.0	
SSA3004	3" x 4"	4.0	
SSA4004	4" x 4"	5.0	
SSA4005	4" x 5"	7.0	
SSA4006	4" x 6"	8.0	
SSA4007	4" x 7"	10.0	
SSA5005	5" x 5"	8.0	
SSA5006	5" x 6"	9.0	
SSA5007	5" x 7"	10.0	
SSA5008	5" x 8"	12.0	
SSA6006	6" x 6"	13.0	
SSA6007	6" x 7"	14.0	
SSA6008	6" x 8"	16.0	
SSA8008	8" x 8"	17.0	

TEE

Part No.	Size	Weight Lbs.	Price
WT333	3" x 3" x 3"	1.50	
WT444	4" x 4" x 4"	2.00	
WT555	5" x 5" x 5"	2.50	
WT666	6" x 6" x 6"	3.00	
WT888	8" x 8" x 8"	5.75	
WT101010	10" x 10" x 10"	8.00	



45° ELBOW

Part No.	Size	Weight Lbs.	Price
WE4-3	3"	1.00	
WE4-4	4"	1.00	
WE4-5	5"	1.50	
WE4-6	6"	2.00	
WE4-8	8"	3.50	
WE4-10	10"	4.75	



90° ELBOW

Part No.	Size	Weight Lbs.	Price
WE9-3	3"	1.50	
WE9-4	4"	1.74	
WE9-5	5"	2.25	
WE9-6	6"	4.00	
WE9-8	8"	6.00	
WE9-10	10"	9.50	



FLANGE

Part No.	Size	Weight Lbs.	Price
APF300	3"	3.00	
APF400	4"	4.00	
APF500	5"	5.00	
APF600	6"	6.00	
APF800	8"	7.75	
APF1000	10"	12.00	
APF1200	12"	17.00	
APF1400	14"	20.00	



INTRO
1. ELECTRICAL
2. PUMP ACC.
3. HOSE, PE PIPE & ACC.
4. IPS, PIP PIPE & ACC.
5. SURFACE
6. SPRINKLERS
7. TRAVELER & WHEEL MOVE
8. PIVOT
9. TURN
10. LOW VOLUME
11. FILTERS
12. INJECTION
13. HARDWARE
INDEX

WELD-ON FITTINGS - ALUMINUM

BAND & LATCH & RING LOCK MALE END



Part No.	Size	Weight Lbs.	Price
RFE0500-ME	5"	2.50	
RFE0600-ME	6"	3.25	

END PLUG COVER



Part No.	Size	Weight Lbs.	Price
WEPC600	6"	1.50	
WEPC700	7"	2.25	
WEPC800	8"	2.50	
WEPC1000	10"	3.25	

LATCH POCKET



Part No.	Size	Weight Lbs.	Price
WLP34	3" & 4"	.20	
WLP56	5" & 6"	.25	

HOOK BRACKET

WHB		.30	
-----	--	-----	--

CAST CONCENTRIC CONE



Part No.	Size	Weight Lbs.	Price
DC1004	1-1/2" x 4"	1.25	
DC1006	1-1/4" x 6"	2.50	
AWC210	*2" x 10"	2.50	

* Stepped Style

CONCENTRIC CONE



Part No.	Size	Weight Lbs.	Price
WC406	4" x 6"	1.75	
WC608	6" x 8"	2.25	
WC8010	8" x 10"	4.00	
WC1012	10" x 12"	6.00	

CAST ECCENTRIC CONE



Part No.	Size	Weight Lbs.	Price
ESA1503	1-1/2" x 3"	1.25	
ESA1504	1-1/2" x 4"	2.00	
ESA1505	1-1/2" x 5"	2.75	
ESA2506	2-1/2" x 6"	3.25	
ESA3008	3" x 8"	5.25	

HALF NIPPLE

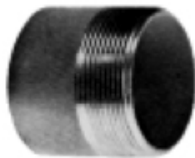

Part No.	Size	Weight Lbs.	Price
NA050	1/2"	.19	
NA075	3/4"	.19	
NA100	1"	.19	
NA125	1-1/4"	.25	
NA150	1-1/2"	.28	
NA200	2"	.31	
NA250	2-1/2"	.38	
NA300	3"	.57	
NA400	4"	.88	
NA500	5"	1.13	
NA600	6"	1.38	
NA800	8"	3.00	

HALF COUPLER



Part No.	Size	Weight Lbs.	Price
HC050	1/2"	.25	
HC075	3/4"	.25	
HC100	1"	.32	
HC125	1-1/4"	.44	
HC150	1-1/2"	.50	
HC200	2"	1	
HC250	2-1/2"	1	
HC300	3"	1.40	
HC400	4"	1.50	
HC500	5"	1.50	
HC600	6"	1.60	

SCH. 40 BLACK BUTT WELD FITTINGS - STEEL

TEE - SCH. 40

Part No.	Size	Price
MNT08	2"	
MNT10	3"	
MNT10	4"	
MNT12	5"	
MNT13	6"	
MNT14	8"	
MNT15	10"	



90° ELL - SCH. 40

Part No.	Size	Price
MN90LR08	2"	
MN90LR10	3"	
MN90LR10	4"	
MN90LR12	5"	
MN90LR13	6"	
MN90LR14	8"	
MN90LR15	10"	



45° ELL - SCH. 40

Part No.	Size	Price
MN45LR08	2"	
MN45LR10	3"	
MN45LR10	4"	
MN45LR12	5"	
MN45LR13	6"	
MN45LR14	8"	
MN45LR15	10"	



CAP - SCH. 40

Part No.	Size	Price
MNCA08	2"	
MNCA10	3"	
MNCA10	4"	
MNCA12	5"	
MNCA13	6"	
MNCA14	8"	
MNCA15	10"	



CONCENTRIC REDUCER - SCH. 40

Part No.	Size	Price
MNCR1008	3" x 2"	
MNCR1108	4" x 2"	
MNCR1110	4" x 3"	
MNCR1210	5" x 3"	
MNCR1211	5" x 4"	
MNCR1310	6" x 3"	
MNCR1311	6" x 4"	
MNCR1312	6" x 5"	
MNCR1411	8" x 4"	
MNCR1412	8" x 5"	
MNCR1413	8" x 6"	
MNCR1512	10" x 5"	
MNCR1513	10" x 6"	
MNCR1514	10" x 8"	
MNCR1615	12" x 10"	



ECCENTRIC REDUCER - SCH. 40

Part No.	Size	Price
MNER1008	3" x 2"	
MNER1108	4" x 2"	
MNER1110	4" x 3"	
MNER1210	5" x 3"	
MNER1211	5" x 4"	
MNER1310	6" x 3"	
MNER1311	6" x 4"	
MNER1312	6" x 5"	
MNER1411	8" x 4"	
MNER1412	8" x 5"	
MNER1413	8" x 6"	
MNER1512	10" x 5"	
MNER1513	10" x 6"	
MNER1514	10" x 8"	



INTRO
1. ELECTRICAL
2. PUMP ACC.
3. HOSE, PE PIPE & ACC.
4. FPS, PIP PIPE & ACC.
5. SURFACE
6. SPRINKLERS
7. TRAVELER & WHEEL MOVE
8. PIVOT
9. TURN
10. LOW VOLUME
11. FILTERS
12. INJECTION
13. HARDWARE
INDEX

CONCENTRIC CONES

PIERCE - 12 GAUGE

Part No.	Size	Price
P1081-02	3" x 2"	
P1081-03	4" x 2"	
P1081-09	4" x 3"	
P1081-10	5" x 3"	
P1081-14	5" x 4"	
P1081-15	6" x 4"	
P1081-19	6" x 5"	
P1081-23	6" x 7"	
P1081-27	7" x 8"	
P1081-24	8" x 6"	
P1081-29	9" x 8"	
P1081-30	10" x 8"	
P1081-34	12" x 10"	



TRAVIS - 14 GAUGE / 12 GAUGE

Part No.	Size	Price	
		14 Gauge	12 Gauge
BWC-14-23	2" x 3"		
BWC-14-24	2" x 4"		
BWC-14-34	3" x 4"		
BWC-14-35	3" x 5"		
BWC-14-45	4" x 5"		
BWC-14-36	3" x 6"		
BWC-14-46	4" x 6"		
BWC-14-56	5" x 6"		
BWC-14-67	6" x 7"		
BWC-14-48	4" x 8"		
BWC-14-58	5" x 8"		
BWC-14-68	6" x 8"		
BWC-12-78	7" x 8"		
BWC-12-89	8" x 9"		
BWC-12-810	8" x 10"		
BWC-12-910	9" x 10"		
BWC-12-1210	10" x 12"		

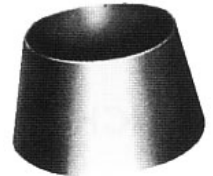

PIERCE - 10 GAUGE

Part No.	Size	Price
P0038-80	4" x 2"	
P3684-01	4" x 3"	
P3684-09	5" x 3"	
P3684-02	5" x 4"	
P3684-03	6" x 4"	
P3684-04	6" x 5"	
P3684-05	8" x 6"	
P3684-06	10" x 8"	
P3684-07	12" x 10"	

TRAVIS - 10 GAUGE

Part No.	Size	Price
BWC-10-46	4" x 6"	
BWC-10-56	5" x 6"	
BWC-10-67	6" x 7"	
BWC-10-48	4" x 8"	
BWC-10-58	5" x 8"	
BWC-10-68	6" x 8"	
BWC-10-78	7" x 8"	
BWC-10-89	8" x 9"	
BWC-10-810	8" x 10"	
BWC-10-910	9" x 10"	
BWC-10-1012	10" x 12"	

ECCENTRIC CONES

PIERCE - 12 GAUGE

Part No.	Size	Price
P1734-01	3" x 2"	
P1734-03	4" x 3"	
P1735-03	5" x 3"	
P1734-06	5" x 4"	
P1735-04	6" x 3"	
P1735-06	6" x 4"	
P1734-08	6" x 5"	
P1736-03	8" x 4"	
P1735-10	8" x 5"	
P1735-12	8" x 6"	
P1735-14	10" x 8"	
P1735-16	12" x 10"	



TRAVIS - 14 GAUGE / 12 GAUGE

Part No.	Size	Price	
		14 Gauge	12 Gauge
BEC-32	3" x 2"		
BEC-42	4" x 2"		
BEC-43	4" x 3"		
BEC-53	5" x 3"		
BEC-54	5" x 4"		
BEC-63	6" x 3"		
BEC-64	6" x 4"		
BEC-65	6" x 5"		
BEC-84	8" x 4"		
BEC-85	8" x 5"		
BEC-86	8" x 6"		
BEC-106	10" x 6"		
BEC-108	10" x 8"		
BEC-126	12" x 6"		
BEC-128	12" x 8"		
BEC-1210	12" x 10"		



TEE

PIERCE

Part No.	Size	Price
P1076-16	6"	
P1076-24	8"	
P1076-30	10"	
P1076-35	12"	



TRAVIS

Part No.	Size	Price
SWT300	3"	
SWT400	4"	
SWT500	5"	
SWT600	6"	
SWT800	8"	
SWT1000	10"	
SWT1200	12"	



CLEMONS TEE

Part No.	Size	Price
TEE-04	4" O.D.	
TEE-06	6" O.D.	
TEE-08	8" O.D.	
TEE-10	10" O.D.	
TEE-12	12" O.D.	

90° ELBOW

PIERCE SWEEP

Part No.	Size	Price
P1097-12	3"	
P1097-13	4"	
P1097-15	6"	



TRAVIS SWEEP

Part No.	Size	Price
SWE300	3"	
SWE400	4"	



TRAVIS MITERED

Part No.	Size	Price
SWE500	5"	
SWE600	6"	
SWE800	8"	
SWE1000	10"	



PIERCE MITERED

Part No.	Size	Price
P1110-05	8"	
P1110-06	10"	
P1110-07	12"	



CLEMONS 90° ELBOW

Part No.	Size	Price
EL-04-90	4" O.D.	
EL-06-90	6" O.D.	
EL-08-90	8" O.D.	
EL-10-90	10" O.D.	
EL-12-90	12" O.D.	

45° ELBOW

PIERCE SWEEP

Part No.	Size	Price
P1100-12	3"	
P1100-13	4"	
P1100-15	6"	



TRAVIS MITERED

Part No.	Size	Price
SWE-45300	3"	
SWE-45400	4"	
SWE-45500	5"	
SWE-45600	6"	
SWE-45700	7"	
SWE-45800	8"	
SWE-451000	10"	

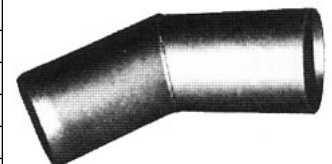

PIERCE MITERED

Part No.	Size	Price
P1111-05	8"	
P1111-06	10"	
P1111-07	12"	



CLEMONS 45° ELBOW

Part No.	Size	Price
EL-04-45	4" O.D.	
EL-06-45	6" O.D.	
EL-08-45	8" O.D.	
EL-10-45	10" O.D.	
EL-12-45	12" O.D.	

HOSE BARBS

PIERCE

Part No.	Size	Price
P1790-02	3"	
P1790-04	4"	
P1790-05	4-1/2"	
P1790-06	5"	
P1790-07	6"	
P1790-08	8"	



TRAVIS

Part No.	Size	Price
HOSEBEAD-2	2"	
HOSEBEAD-21/2	2-1/2"	
HOSEBEAD-3	3"	
HOSEBEAD-4	4"	
HOSEBEAD-41/2	4-1/2"	
HOSEBEAD-5	5"	
HOSEBEAD-6	6"	
HOSEBEAD-8	8"	
HOSEBEAD-10	10"	
HOSEBEAD-12	12"	



FLAT DISCS

PIERCE

Part No.	Size	Price
P1067-02	2"	
P1067-05	3"	
P1067-09	4"	
P1067-11	5"	
P1067-14	6"	
P1067-21	8"	
P1067-25	10"	
P1067-29	12"	

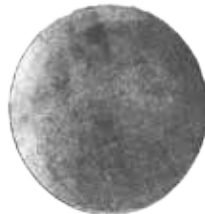

TRAVIS

Part No.	Size	Price
WD-2	2"	
WD-3	3"	
WD-4	4"	
WD-5	5"	
WD-6	6"	
WD-658	6-5/8"	
WD-7	7"	
WD-8	8"	
WD-10	10"	
WD-12	12"	

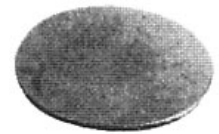

1/2" CARBON STEEL PLATE FLANGES

OD PIPE SIZE

Part No.	Size	Price
CPFH0200-16	2"	
CPFH0250-16	2-1/2"	
CPFH0300-16	3"	
CPFH0400-16	4"	
CPFH0500-16	5"	
CPFH0600-16	6"	
CPFH0800-16	8"	
CPFH1000-16	10"	
CPFH1200-16	12"	
CPFH1400	14"	
CPFH1600	16"	



IPS PIPE SIZE

Part No.	Size	Price
CPF0200	2"	
CPF0250	2-1/2"	
CPFH0300	3"	
CPFH0400	4"	
CPFH0500	5"	
CPFH0600	6"	
CPFH0800	8"	
CPFH1000	10"	
CPFH1200	12"	



BAND & LATCH FEMALE STARTER COUPLER - STANDARD PUNCH



TRAVIS

Part No.	Size	Price
SCBHB200	2"	
SCBHB300	3"	
SCBHB400	4"	
SCBHB500	5"	
SCBHB600	6"	
SCBHB700	7"	
SCBHB800	8"	
SCBHB1000	10"	
SCBHB1200	12"	



RING LOCK MALE STARTER COUPLER

PIERCE

Part No.	Size	Price
P1678-02	4"	
P1676-01	5"	
P1676-02	6"	
P1676-04	8"	
P1676-05	10"	
P1676-06	12"	



TRAVIS

Part No.	Size	Price
SCBM300	3"	
SCBM400	4"	
SCBM500	5"	
SCBM600	6"	
SCBM800	8"	
SCBM1000	10"	
SCBM1200	12"	



RING LOCK FEMALE STARTER COUPLER - STANDARD PUNCH

PIERCE

Part No.	Size	Price
P1669-42	4"	
P1669-44	6"	
P1669-46	8"	
P1669-47	10"	
P1669-48	12"	



TRAVIS

Part No.	Size	Price
SCB200	2"	
SCB300	3"	
SCB400	4"	
SCB500	5"	
SCB600	6"	
SCB800	8"	
SCB1000	10"	
SCB1200	12"	



RING LOCK FEMALE STARTER COUPLER - DEEP PUNCH

PIERCE

Part No.	Size	Price
P1007-41	2"	
P1007-42	3"	
P1007-43	4"	
P1007-44	5"	
P1007-45	6"	
P1007-47	8"	
P1007-48	10"	
P1007-49	12"	



TRAVIS

Part No.	Size	Price
SCB400D	4"	
SCB500D	5"	
SCB600D	6"	
SCB800D	8"	
SCB1000D	10"	
SCB1200D	12"	



INTRO
 1. ELECTRICAL
 2. PUMP Acc.
 3. HOSE, PE PIPE & Acc.
 4. IPS, PIP Pipe & Acc.
 5. SURFACE
 6. SPRINKLERS
 7. TRAVELER & WHEEL MOVE
 8. PIVOT
 9. TURF
 10. LOW VOLUME
 11. FILTERS
 12. INJECTION
 13. HARDWARE
 INDEX

BAND & LATCH FEMALE STARTER COUPLER

PIERCE

Part No.	Size	Price
P1048-62	3"	
P1048-63	4"	
P1048-64	5"	
P1048-65	6"	
P1048-67	8"	



TRAVIS

Part No.	Size	Price
SCGHB200	2"	
SCGHB300	3"	
SCGHB400	4"	
SCGHB500	5"	
SCGHB600	6"	
SCGHB700	7"	
SCGHB800	8"	
SCGHB1000	10"	
SCGHB1200	12"	



RING LOCK MALE STARTER COUPLER

PIERCE

Part No.	Size	Price
P1678-12	4"	
P1676-11	5"	
P1676-12	6"	
P1676-14	8"	
P1676-15	10"	



TRAVIS

Part No.	Size	Price
SCGM300	3"	
SCGM400	4"	
SCGM500	5"	
SCGM600	6"	
SCGM800	8"	
SCGM1000	10"	
SCGM1200	12"	



RING LOCK FEMALE STARTER COUPLER - STANDARD PUNCH

PIERCE

Part No.	Size	Price
P1669-12	4"	
P1669-14	6"	
P1669-16	8"	
P1669-17	10"	
P1669-18	12"	



TRAVIS

Part No.	Size	Price
SCG200	2"	
SCG300	3"	
SCG400	4"	
SCG500	5"	
SCG600	6"	
SCG800	8"	
SCG1000	10"	
SCG1200	12"	



RING LOCK FEMALE STARTER COUPLER - DEEP PUNCH

PIERCE

Part No.	Size	Price
P1007-53	4"	
P1007-54	5"	
P1007-55	6"	
P1007-57	8"	
P1007-58	10"	
P1007-59	12"	



TRAVIS

Part No.	Size	Price
SCG400D	4"	
SCG500D	5"	
SCG600D	6"	
SCG800D	8"	
SCG1000D	10"	
SCG1200D	12"	



FEMALE STARTER COUPLER

**PIERCE
IPS FEMALE STARTER COUPLER**

Part No.	Size	Price
P1001-11	2"	
P1001-12	2-1/2"	
P1001-13	3"	
P1001-14	4"	
P1001-15	5"	
P1001-16	6"	
P1001-17	8"	
P1001-18	10"	
P1001-19	12"	



**TRAVIS
IPS FEMALE STARTER COUPLER**

Part No.	Size	Price
IPS-SC-4	4"	
IPS-SC-5	5"	
IPS-SC-6	6"	
IPS-SC-8	8"	
IPS-SC-10	10"	
IPS-SC-12	12"	

**PIERCE
PIP FEMALE STARTER COUPLER**

Part No.	Size	Price
P1003-11	4"	
P1003-12	6"	
P1003-13	8"	
P1003-14	10"	
P1003-15	12"	
P1133-01	15"	
P1006-03	18"	

**TRAVIS
PIP FEMALE STARTER COUPLER**

Part No.	Size	Price
PIP-SC-6	6"	
PIP-SC-8	8"	
PIP-SC-10	10"	
PIP-SC-12	12"	
PIP-SC-15	15"	

BOLTED STARTER COUPLER SET

**PIERCE WEDGE-TITE®
IPS BOLTED STARTER COUPLER SET**

Part No.	Size	Price
P9017-01	4"	
P9018-01	5"	
P9019-01	6"	
P9020-01	8"	
P9021-01	10"	
P9022-01	12"	



**TRAVIS BOLT-TITE
IPS BOLTED STARTER COUPLER SET**

Part No.	Size	Price
IPS-BTSC-4	4"	
IPS-BTSC-5	5"	
IPS-BTSC-6	6"	
IPS-BTSC-8	8"	
IPS-BTSC-10	10"	
IPS-BTSC-12	12"	

**PIERCE WEDGE-TITE®
PIP BOLTED STARTER COUPLER SET**

Part No.	Size	Price
P9017-03	4"	
P9019-03	6"	
P9020-03	8"	
P9021-03	10"	
P9022-03	12"	

**TRAVIS BOLT-TITE
PIP BOLTED STARTER COUPLER**

Part No.	Size	Price
PIP-BTSC-6	6"	
PIP-BTSC-8	8"	
PIP-BTSC-10	10"	
PIP-BTSC-12	12"	
PIP-BTSC-15	15"	
PIP-BTSC-18.7	18.7"	
PIP-BTSC-20.4	20.4"	

PIERCE 52" Z-PIPE

PLAIN END X IPS BELL

Part No.	Plain End	IPS Bell	Air	Gauge Port	Price
P3706-01	4"	4"	3"	3/4"	
P3706-02	5"	5"	3"	3/4"	
P3706-03	6"	6"	3"	3/4"	
P3706-04	8"	8"	3"	3/4"	
P3706-05	10"	10"	3"	3/4"	
P3706-06	12"	12"	3"	3/4"	



FLANGE X IPS BELL

Part No.	Flange	IPS Bell	Air	Gauge Port	Price
P3120-01	4"	4"	-	-	
P3120-03	6"	6"	-	-	
P3120-04	8"	8"	-	-	
P3120-05	10"	10"	-	-	
P3120-06	12"	12"	-	-	



TRAVIS 52" Z-PIPE

PLAIN END X IPS BELL

Part No.	Plain End	IPS Bell	Air	Gauge Port	Price
IPS-Z-4	4"	4"	3"	3/4"	
IPS-Z-6	6"	6"	3"	3/4"	
IPS-Z-8	8"	8"	3"	3/4"	
IPS-Z-10	10"	10"	3"	3/4"	
IPS-Z-12	12"	12"	3"	3/4"	

Add GALV. after part number for galvanized (same price) example - IPS-Z-4-FLG-GALV



FLANGE X IPS BELL

Part No.	Flange	IPS Bell	Air	Gauge Port	Price
IPS-Z-4-FLG	4"	4"	3"	3/4"	
IPS-Z-6-FLG	6"	6"	3"	3/4"	
IPS-Z-8-FLG	8"	8"	3"	3/4"	
IPS-Z-10-FLG	10"	10"	3"	3/4"	
IPS-Z-12-FLG	12"	12"	3"	3/4"	

Add GALV. after part number for galvanized (same price) example - IPS-Z-4-FLG-GALV

Note: To order a Z-Pipe with a PIP belled coupler outlet, simply change the IPS prefix on the part number to PIP.

POTS / PUMP STANDS

Most are built, in stock and ready to install, these pre-manufactured pump stands are designed to save you time and money by increasing your efficiency. No more waiting around for pump stands to be built. Get all of your materials to the job site sooner, get them installed, then off to the next job. These pump stands are manufactured from your choice of light wall (.188 w.t.) or heavy wall (.250 w.t.) steel pipe and stand 6.66 ft. tall. They are supplied with a plain end outlet, ready to accept a weld-on starter coupler, or pipe and draw bands. Since all pump stand tie-ins are custom fitted to each specific job and as a result require an on-site welder, the inlet is to be cut and adapted as necessary in the field. Also, since there is a personal preference as to the fitting and size selection of the air and pressure relief connections which are welded on top of the pump stand, the top can be supplied plain, allowing each dealer to customize it during tie-in and according to job requirements, or with fittings already welded.

Outlet Size	Casing Size	Wall Thickness	Plain Top Part No.	Price Ea.	Top w/Fittings Part No.	Price Ea.
4"	6"	.188"	PS4X6-188		PS4X6-188WF	
4"	6"	.250"	PS4X6-250		PS4X6-250WF	
4" x 4"	6"	.250"	PS44X6-250		PS44X6-250WF	
6"	6"	.188"	PS6X6-188		PS6X6-188WF	
6"	6"	.250"	PS6X6-250		PS6X6-250WF	
6"	8"	.188"	PS6X8-188		PS6X8-188WF	
6"	8"	.250"	PS6X8-250		PS6X8-250WF	
6"	10"	.188"	PS6X10-188		PS6X10-188WF	
6"	10"	.250"	PS6X10-250		PS6X10-250WF	
6"	12"	.188"	PS6X12-188		PS6X12-188WF	
6"	12"	.250"	PS6X12-250		PS6X12-250WF	
6" x 6"	8"	.188"	PS66X8-188		PS66X8-188WF	
6" x 6"	8"	.250"	PS66X8-250		PS66X8-250WF	
6" x 6"	10"	.188"	PS66X10-188		PS66X10-188WF	
6" x 6"	10"	.250"	PS66X10-250		PS66X10-250WF	
6" x 6"	12"	.188"	PS66X12-188		PS66X12-188WF	
6" x 6"	12"	.250"	PS66X12-250		PS66X12-250WF	
8"	8"	.188"	PS8X8-188		PS8X8-188WF	
8"	8"	.250"	PS8X8-250		PS8X8-250WF	
8"	10"	.188"	PS8X10-188		PS8X10-188WF	
8"	10"	.250"	PS8X10-250		PS8X10-250WF	
8"	12"	.188"	PS8X12-188		PS8X12-188WF	
8"	12"	.250"	PS8X12-250		PS8X12-250WF	
8"	14"	.250"	PS8X14-250		PS8X14-250WF	
8" x 8"	10"	.188"	PS88X10-188		PS88X10-188WF	
8" x 8"	10"	.250"	PS88X10-250		PS88X10-250WF	
8" x 8"	12"	.188"	PS88X12-188		PS88X12-188WF	
8" x 8"	12"	.250"	PS88X12-250		PS88X12-250WF	
8" x 8"	14"	.250"	PS88X14-250		PS88X14-250WF	
10"	10"	.188"	PS10X10-188		PS10X10-188WF	
10"	10"	.250"	PS10X10-250		PS10X10-250WF	
10"	12"	.188"	PS10X12-188		PS10X12-188WF	
10"	12"	.250"	PS10X12-250		PS10X12-250WF	
10"	14"	.250"	PS10X14-250		PS10X14-250WF	
10"	16"	.250"	PS10X16-250		PS10X16-250WF	
10" x 10"	12"	.188"	PS1010X12-188		PS1010X12-188WF	
10" x 10"	12"	.250"	PS1010X12-250		PS1010X12-250WF	
10" x 10"	14"	.250"	PS1010X14-250		PS1010X14-250WF	
10" x 10"	16"	.250"	PS1010X16-250		PS1010X16-250WF	
12"	14"	.250"	PS12X14-250		PS12X14-250WF	
12"	16"	.250"	PS12X16-250		PS12X16-250WF	
12"	18"	.250"	PS12X18-250		PS12X18-250WF	
15"	18"	.250"	PS15X18-250		PS15X18-250WF	
15"	24"	.250"	PS15X24-250		PS15X24-250WF	



IF YOU DON'T SEE WHAT YOU'RE NEEDING, CUSTOM POTS ARE BUILT UPON REQUEST.

INTRO
 1. ELECTRICAL
 2. PUMP ACC.
 3. HOSE, PE PIPE & ACC.
 4. IPS, PIP PIPE & ACC.
 5. SURFACE
 6. SPRINKLERS
 7. TRAVELER & WHEEL MOVE
 8. PIVOT
 9. TURF
 10. LOW VOLUME
 11. FILTERS
 12. INJECTION
 13. HARDWARE
 INDEX

SECTION 3

HOSE, POLYETHYLENE PIPE, FITTINGS & CLAMPS

CONTENTS

- 3:3 HOSE, FITTINGS & CLAMP NOTES
- 3:4 WATER HOSE
- 3:4 GILMOUR COMMERCIAL / INDUSTRIAL HOSE
- 3:4 GILMOUR FLEXOGEN® HOSE
- 3:4 KURIYAMA KURI-TEC A1317 REINFORCED PVC WATER HOSE
- 3:5-8 DISCHARGE HOSE
- 3:9-10 LAYFLAT WATER DISCHARGE HOSE
- 3:11-14 SUCTION & DISCHARGE HOSE
- 3:15 HOSE NOZZLES
- 3:16 HOSE THREAD SHUT-OFF VALVES & QUICK CONNECTORS
- 3:17 HOSE COUPLINGS & MENDERS
- 3:18-19 HOSE COUPLINGS, FITTINGS & ADAPTERS
- 3:20-24 CAM LEVER FITTINGS
- 3:20 BANJO® GARDEN HOSE QUICK-ACTING FITTINGS
- 3:21 POLYPROPYLENE QUICK-ACTING FITTINGS
- 3:22 ALUMINUM QUICK-ACTING FITTINGS
- 3:23 TYPE 304 STAINLESS STEEL QUICK-ACTING FITTINGS
- 3:24 TYPE 316 STAINLESS STEEL QUICK-ACTING FITTINGS
- 3:25 POLYPROPYLENE HOSE BARB FITTINGS
- 3:26 HOSE BARB KING NIPPLES & MENDERS
- 3:27-28 LOW PRESSURE ALUMINUM HOSE BARB FITTINGS
- 3:29-30 STEEL HOSE BARB FITTINGS
- 3:31 ID CONTROLLED POLYETHYLENE PLASTIC PIPE
- 3:32 IPS OD CONTROLLED POLYETHYLENE PLASTIC PIPE
- 3:33-35 IPS HDPE MOLDED & FABRICATED FITTINGS
- 3:36 FUSION MACHINES
- 3:37-38 PVC INSERT FITTINGS
- 3:39-42 IPS HDPE COMPRESSION FITTINGS
- 3:43 POLYMATE® ADAPTERS
- 3:44 SADDLES, SPLICERS AND ADAPTERS
- 3:45 INSERT FITTINGS AND CLAMPS
- 3:46-49 CLAMPS
- 3:46 MURRAY GOLD SEAL® WORM GEAR HOSE CLAMPS
- 3:46 DIXON STAINLESS WORM GEAR HOSE CLAMPS
- 3:47 CLAMPKO T-BOLT CLAMPS
- 3:48 CENTER PUNCH CLAMPS
- 3:48 SPIRAL DOUBLE BOLT CLAMPS
- 3:48 DUCTILE IRON DOUBLE BOLT CLAMPS
- 3:49 DRAW BANDS
- 3:50 WELD-ON FITTINGS - ALUMINUM
- 3:51 PATCH CLAMPS



GILMOUR COMMERCIAL / INDUSTRIAL HOSE

If you're looking for a high quality yet economical hose option for home, garden, commercial or industrial use, you just found it! Consider these features:

- 6-Ply construction provides a heavy-duty industrial strength hose for home, shop or commercial use
- 500 PSI Burst Strength
- Double reinforced high tensile yarn reinforcement
- Large 3/4" inside diameter for increased flow
- Heavy-duty brass couplings with O-ring for tight seals
- Maximum kink resistance
- Rubber / Vinyl construction makes hose weather resistant for long life & ease of handling
- Rugged red cover resists abrasion & won't mar surfaces
- Metal spring protective collar prevents kinks at faucet
- Long 75' length to reach those hard to get to places



Part No.	Size	Description	Price
25-34025	3/4" x 25'	Commercial Rubber / Vinyl Hose	
25-34050	3/4" x 50'	Commercial Rubber / Vinyl Hose	
25-34075	3/4" x 75'	Commercial Rubber / Vinyl Hose	
29-58050	5/8" x 50'	Commercial Rubber / Vinyl Hose	

GILMOUR FLEXOGEN® HOSE

Flexogen® is the hose that has long set the standard for quality in garden hoses. Recognized by consumers & trade alike, it offers the ultimate in quality and value. Promoted by Gilmour as "The Last Hose You'll Ever Buy!", Flexogen® is sold with a full lifetime replacement policy. Consider these features which relate to the best garden hose on the market today & the best hose you'll ever buy:

- Patent pending 8-ply construction (6-ply on 1" diameter hose)
- Over 500 PSI Burst Strength
- Strong enough to hold the highest pressure on the hottest day
- Double tire cord reinforced for strength
- Lightweight, coils & handles easily in all weather
- Flow Guard Plus protective collar on 5/8" & 1/2" hoses resist kinking at faucet
- Heavy-duty, crush resistant, Full-Flo brass couplings on 1", 3/4" & 5/8" hose with built-in washer for tight sealing
- Maximum kink resistance
- Polished surface resists abrasions, stains & mildew
- Full Lifetime Replacement Policy



Part No.	Nominal ID	Length	Carton Qty.	LBS. / Coil	Price / Coil
10-12100	1/2"	100'	3	12	
10-58100	5/8"	100'	2	16	
10-34100	3/4"	100'	1	20	
10-10100	1"	100'	1	41	
10-10050	1"	50'	2	19	

Note: Other lengths available upon request.

KURIYAMA KURI-TEC A1317 REINFORCED PVC WATER HOSE

For folks who want to custom-make their own hose, we are glad to provide bulk coils of this all-purpose heavy-duty PVC hose that's ideal for golf courses, parks & other large areas. It is constructed with a smooth black PVC tube, high tensile strength reinforcement & a smooth transparent green PVC cover. It features high working & burst pressures, an abrasion resistant cover & good resistance to weather aging.

Part No.	Nominal ID	Length	Working PSI	LBS. / Coil	Price / Coil
A131712X300	3/4"	300'	125	65	
A131716X300	1"	200' / 300'	125	60 / 90	



KURIYAMA K050 SERIES UTILITY GRADE PVC CLEAR TUBING

This non-toxic food & beverage grade non-reinforced clear vinyl tubing is constructed from clear PVC compound which gives it a high gloss - blue tint crystal clear appearance with glass smooth interior to reduce sediment build-up. The service temperature range is 25°F to 150°F.

Part No.	Nominal ID	Nominal OD	Working PSI	Coil Length	Price
K050-0204X100	1/8"	1/4"	65	100'	
K050-0305X100	3/16"	5/16"	55	100'	
K050-0406X100	1/4"	3/8"	55	100'	
K050-0408x100	1/4"	1/2"	60	100'	
K050-0507X100	5/16"	7/16"	50	100'	
K050-0608X100	3/8"	1/2"	45	100'	
K050-0609X100	3/8"	9/16"	50	100'	
K050-0610X100	3/8"	5/8"	55	100'	
K050-0810X100	1/2"	5/8"	30	100'	
K050-0812X100	1/2"	3/4"	45	100'	
K050-1013X100	5/8"	13/16"	35	100'	
K050-1014X100	5/8"	7/8"	40	100'	
K050-1216X100	3/4"	1"	35	100'	
K050-1418X100	7/8"	1-1/8"	30	100'	
K050-1620X100	1"	1-1/4"	25	100'	
K050-2024X50	1-1/4"	1-1/2"	20	50'	
K050-2430X50	1-1/2"	1-7/8"	30	50'	
K050-2432X50	1-1/2"	2"	35	50'	
K050-3240X50	2"	2-1/2"	35	50'	



KURIYAMA KLEARON™ CLEAR VINYL TUBING

This non-toxic food & beverage grade non-reinforced clear vinyl tubing is constructed from clear PVC compound which gives it a high gloss - blue tint crystal clear appearance with glass smooth interior to reduce sediment build-up. The service temperature range is 25°F to 150°F.

Part No.	Nominal ID	Nominal OD	Working PSI	Coil Length	Price
K010-0305	3/16"	5/16"	55	100'	
K010-0406	1/4"	3/8"	55	100'	
K010-0609	3/8"	5/8"	50	100'	
K010-0811	1/2"	11/16"	40	100'	
K010-1216	3/4"	1"	35	100'	
K010-1620	1"	1-1/4"	25	100'	



KURIYAMA 220 SERIES - LLDPE POLYETHYLENE TUBING - FOOD GRADE

Linear low density food grade polyethylene tubing in compliance with FDA(06) requirements - natural color. Also in compliance with RoHS(15) requirements. The service temperature range is 50°F to 140°F.

Part No.	Nominal ID	Nominal OD	Working PSI	Coil Length	Price
220-0862X500	3/8"	1/2"	100	500'	
220-0862X100	3/8"	1/2"	100	100'	



INTRO
 1. ELECTRICAL
 2. PUMP Acc.
 3. HOSE, PE PIPE & Acc.
 4. IPS, PIP Pipe & Acc.
 5. SURFACE
 6. SPRINKLERS
 7. TRAVELER & WHEEL MOVE
 8. PIVOT
 9. TURN
 10. LOW VOLUME
 11. FILTERS
 12. INJECTION
 13. HARDWARE
 INDEX

KURIYAMA CLEARBRAID® CLEAR REINFORCED HOSE

This non-toxic food & beverage grade reinforced tubing is constructed from crystal clear PVC compound and reinforced with spiraled polyester yarn & multiple longitudinal polyester yarn to reduce elongation under pressure. The service temperature range is 25°F to 150°F.

Part No.	Nominal ID	Nominal OD	Working PSI	Coil Length	Price
K3150-04	1/4"	.438"	250	100' / 300'	
K3150-06	3/8"	.594"	225	100' / 300'	
K3150-08	1/2"	.750"	200	100' / 300'	
K3150-12	3/4"	1.031"	150	100' / 200'	
K3150-16	1"	1.300"	125	100' / 200'	



KURIYAMA EVA TRANSLUCENT REINFORCED HOSE

This hose is highly flexible and has excellent chemical resistance. It is commonly used with fertilizer & chemigation pumps for various chemical application including anhydrous ammonia fertilizer. It is constructed with translucent EVA copolymer & high tensile strength yarn. The service temperature range is -30°F to 150°F.

Part No.	Nominal ID	Nominal OD	Working PSI	Coil Length	Price
K4350-06	3/8"	.594"	300	300' / 500'	
K4350-08	1/2"	.719"	250	300' / 500'	
K4350-12	3/4"	.970"	150	300'	
K4350-16	1"	1.313"	150	200'	



KURIYAMA KURI TEC® GENERAL PURPOSE AIR & WATER HOSE

This hose is used for the transfer of air, water & mild water soluble chemicals. It is U.V. & weather resistant, flexible & lightweight, & has excellent abrasion resistance. The hose is constructed from PVC compound with high tensile strength yarn reinforcement. The service temperature range is 14°F to 150°F.

Part No.	Nominal ID	Nominal OD	Working PSI	Coil Length	Price
K1154-04	1/4"	.500"	300	500'	
K1154-16	1"	1.313"	150	300'	



KURIYAMA POLYAIR® MULTI-PURPOSE AIR & WATER HOSE

This hose is great for use with air, water & mild water soluble chemicals. It is U.V. & weather resistant, which makes it ideal for any outdoor application, & it retains flexibility even in cold weather. It is constructed of PVC compound & spiral polyester yarn with additional longitudinal yarns to reduce elongation under pressure. The service temperature range is -15°F to 150°F.

Part No.	Nominal ID	Nominal OD	Working PSI	Coil Length	Price
K1134-08	1/2"	.813"	300	100' / 500'	
K1134-10	5/8"	.906"	250	100' / 300'	
K1134-12	3/4"	1.125"	250	100' / 300'	
K1134-16	1"	1.406"	250	100' / 300'	



Note: WORKING PRESSURE FOR ALL HOSE LISTED ON THIS PAGE IS BASED ON OPERATION AT 70°F.

GOODYEAR HORIZON® 200PSI MULTIPURPOSE AIR & WATER HOSE

This is another great hose for use with air & water. Horizon® is an economical hose used for a wide variety of applications which include agriculture, construction & industrial. It is very flexible & is U.V. & weather resistant. Horizon® is constructed from Versigard® synthetic rubber & spiral synthetic yarn reinforcement. The service temperature range is -40°F to 190°F. It is normally stocked in black for 1/2" & 3/4", & in red for 1", 1-1/4", 1-1/2" & 2". Other colors available for special purchase include blue & yellow. Available for purchase in full coils or by the foot.



Part No.	Nominal ID	Nominal OD	Coil Length	Price / Ft.	Price / Coil
56900912700200	1/2"	0.81"	500'		
56900919100200	3/4"	1.12"	500'		
56901225400200	1"	1.44"	450'		
56901131800200	1-1/4"	1.73"	400'		
56901138100200	1-1/2"	1.98"	300'		
53604006400300	2"	2.50"	200'		

GOODYEAR GORILLA® 500PSI MULTIPURPOSE HOSE

This hose is a premium quality, multipurpose industrial hose with a wide range of applications in agriculture, factories, construction, quarries, mines, railroads, the oil and gas industry & ship building. The hose is constructed with Nitrile synthetic rubber for the tube, spiral Flexten® yarn reinforcement, & yellow Carbyn® synthetic rubber for the cover. Gorilla® hose is rated RMA class A (high oil resistance) & has a service temperature range of -20°F to 190°F. Priced by the foot or in full coils.



Part No.	Nominal ID	Nominal OD	Coil Length	Price / Ft.	Price / Coil
56903512700200	1/2"	0.89"	500'		
56903519100200	3/4"	1.19"	500'		
56903525400200	1"	1.50"	450'		
56903531800200	1-1/4"	1.77"	400'		
56903538100200	1-1/2"	2.04"	300'		
53644606410000	2"	2.62"	200'		

KURIYAMA ALFAGOMMA® T253AA 150PSI SBR WATER DISCHARGE HOSE

This is a medium to heavy-duty 2-ply hose constructed from synthetic black rubber, high tensile textile cord reinforcement & a black weather & ozone resistant SBR rubber cover. It has a service temperature rating of -22°F to 176°F. Common uses are for general industrial, construction & irrigation discharge hose, particularly ideal for center pivot boot material. Priced by the foot or in full coils.



Part No.	Nominal ID	Nominal OD	Coil Length	Price / Ft.	Price / Coil
T253AA150X100	1-1/2"	1.81"	100'		
T253AA200X100	2"	2.32"	100'		
T253AA250X100	2-1/2"	2.80"	100'		
T253AA300X100	3"	3.31"	100'		
T253AA400X100	4"	4.33"	100'		
T253AA600X100	6"	6.38"	100'		
T253AA662X100	6-5/8"	7.01"	100'		
T253AA800X100	8"	8.46"	100'		
T253AA1000X100	10"	10.63"	100'		
T253AA1200X50	12"	12.56"	50'		

GOODYEAR PLICORD® VERSIFLO™ 125PSI RUBBER WATER DISCHARGE HOSE

This is a medium-duty, thin wall, lightweight, pliable hose & is constructed from black Versigard® synthetic rubber with a spiral-plied synthetic fabric reinforcement. The 4" Versiflo™ is our most popular sideroll hose & the 6" is commonly used for water discharge & pivot boot material. The service temperature rating is -25°F to 180°F. Available for purchase by the foot or in full coils.



Part No.	Nominal ID	Nominal OD	Coil Length	Price / Ft.	Price / Coil
54252710701000	3"	3.22"	100'		
54252712301000	4"	4.21"	100' / 400'		
54252715501000	6"	6.32"	100'		

Note: WORKING PRESSURE FOR ALL HOSE LISTED ON THIS PAGE IS BASED ON OPERATION AT 70°F.

NOVAFLEX 2150 RUBBER WATER DISCHARGE HOSE

This is a lightweight to medium-duty hose constructed with a black synthetic rubber tube, polyester tire cord reinforcement & a smooth black weather & abrasion resistant rubber cover. It is used as water discharge hose on many different applications & as boot material for center pivots. It is 2 ply on sizes 1-1/4" through 8-5/8" & 4 ply on sizes 10" through 12-3/4". The maximum operating pressure is size specific & noted in the table below. The service temperature range is -30°F to 180°F. All sizes are available in 100' coils and may be purchased by the foot or by the coil.

Part No.	Nominal ID	Nominal OD	Working PSI	Price / Ft.	Price / Coil
2150BE-01250-00	1-1/4"	1.44"	300		
2150BE-01500-00	1-1/2"	1.69"	250		
2150BE-02000-00	2"	2.19"	200		
2150BE-00250-00	2-1/2"	2.69"	150		
2150BE-03000-00	3"	3.19"	125		
2150BE-03500-00	3-1/2"	3.74"	125		
2150BE-04000-00	4"	4.24"	100		
2150BE-04500-00	4-1/2"	4.88"	100		
2150BE-05000-00	5"	5.32"	100		
2150BE-05563-00	5-9/16"	5.87"	85		
2150BE-06000-00	6"	6.32"	85		
2150BE-06625-00	6-5/8"	6.94"	75		
2150BE-08000-00	8"	8.33"	75		
2150BE-08625-00	8-5/8"	8.95"	75		
2150BE-10000-00	10"	10.43"	75		
2150BE-10750-00	10-3/4"	11.18"	75		
2150BE-12000-00	12"	12.43"	75		
2150BE-12750-00	12-3/4"	13.18"	75		



GOODYEAR PLICORD® HD 4 PLY RUBBER WATER DISCHARGE HOSE

This is a heavy-duty all-purpose hose with excellent U.V. weather & abrasion resistance. It is ideal for use in quarries, mines, construction, agriculture & irrigation, particularly for center pivot or linear boot hose where a heavy 4-ply boot is required. The hose construction is of black Plioflex® synthetic rubber & 4 spiral-ply plies of synthetic fabric. The service temperature rating is -25°F to 180°F. Working pressure : 4" - 6-5/8" is 150 PSI & 8" - 12" is 100 PSI. All sizes are available in 100' coils and may be purchased by the foot or by the coil.

Part No.	Nominal ID	Nominal OD	Length	Price / Ft. or Boot	Price / Coil
54243712301000	4"	4.58"	100'		
54243713101000	4-1/2"	5.07"	100'		
54243713901000	5"	5.57"	100'		
549806139240	5"	5.57"	12"		
5498061392280	5"	5.57"	16"		
54243715501000	6"	6.53"	100'		
549806155240	6"	6.53"	12"		
549806155320	6"	6.53"	16"		
54143716505400	6-5/8"	7.22"	50'		
549806165240	6-5/8"	7.22"	12"		
549806165320	6-5/8"	7.22"	16"		
54143718705405	8"	8.57"	50'		
541806187240	8"	8.57"	12"		
541806187320	8"	8.57"	16"		
54143719805400	8-5/8"	9.19"	50'		
541806197240	8-5/8"	9.19"	12"		
541806197320	8-5/8"	9.19"	16"		
54143721905400	10"	10.63"	50'		
541806219240	10"	10.63"	12"		
541806219340	10"	10.63"	17"		
54143725105400	12"	12.66"	50'		



Note: WORKING PRESSURE FOR ALL HOSE LISTED ON THIS PAGE IS BASED ON OPERATION AT 70°F.

KURIYAMA VINYLFLOW® EZ LITE LAYFLAT HOSE

A general purpose PVC water discharge hose. Features a balanced polyester yarn spiral wrap, longitudinal strength member and homogeneous PVC tube and cover to prevent separation.

Applications include:

- Equipment rental
- Construction
- Agriculture
- General open end water discharge

Part No.	Size	Nominal I.D.	Working PSI	Coil Length	Price / Ft.	Price / Coil
VFL100X300	1"	1.024"	85	300'		
VFL125X300	1-1/4"	1.299"	85	300'		
VFL150X300	1-1/2"	1.61"	65	300'		
VFL200X300	2"	2.09"	65	50' / 300'		
VFL300X300	3"	3.07"	60	50' / 300'		
VFL400X300	4"	4.09"	60	300'		
VFL600X300	6"	6.10"	40	300'		
VFL800X300	8"	8.17"	40	300'		

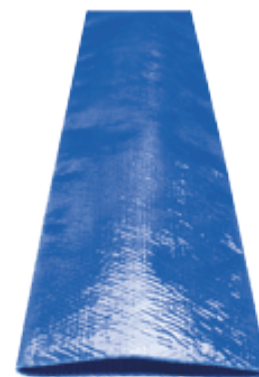

KURIYAMA VINYLFLOW® PREMIUM DRIP IRRIGATION LAYFLAT HOSE

This is a premium water discharge hose featuring a balanced polyester yarn spiral wrap, longitudinal strength member, & homogeneous PVC tube & cover. It is used for general purpose discharge applications, & is ideal for use as a drip irrigation supply line as it can be punched easily without tearing for fitting insertion. Vinylflow® lays straight with minimal elongation under pressure. Its homogeneous tube & cover construction eliminates separation. Ultraviolet inhibitors reduce aging & weather cracking. Sizes 1-1/2" through 8" available in 300' coils and sizes 10" through 16" available in 100' coils. Layflat may be purchased by the foot at a increased price to cover handling.

Part No.	Size	Nominal I.D.	Nominal O.D.	Working PSI	Price / Ft.	Price / Coil
VF150X300	1-1/2"	1.673"	1.807"	80		
VF200X300	2"	2.165"	2.299"	80		
VF250X300	2-1/2"	2.598"	2.755"	80		
VF300X300	3"	3.130"	3.287"	70		
VF400X300	4"	4.134"	4.299"	70		
VF500X300	5"	5.039"	5.212"	40		
VF600X300	6"	6.181"	6.354"	50		
VF800X300	8"	8.169"	8.382"	45		
VF1000X100	10"	10.118"	10.354"	35		
VF1200X100	12"	12.126"	12.362"	30		
VF1400X100	14"	14.134"	14.370"	30		
VF1600X100	16"	16.142"	16.378"	30		



KURIYAMA IRONSIDES® HEAVY-DUTY LAYFLAT HOSE

This hose has a premium quality PVC tube & cover, reinforced with two spiral plies & longitudinal synthetic cords. It is used for irrigation, agriculture, quarry, mining, construction & industrial applications. It has a high working pressure, resists kinking & twisting, making it excellent to use with a portable hydrant or as a relay supply line hose. It has a high U.V./ozone resistance. All sizes are available in 300' coils, or by the foot at a increased price to cover handling.

Part No.	Size	Nominal I.D.	Nominal O.D.	Working PSI	Price / Ft.	Price / Coil
IS150X300	1-1/2"	1.61"	1.783"	150		
IS200X300	2"	2.09"	2.271"	150		
IS250X300	2-1/2"	2.58"	2.769"	150		
IS300X300	3"	3.09"	3.2868"	150		
IS400X300	4"	4.10"	4.320"	125		
IS600X300	6"	6.16"	6.396"	115		
IS800X300	8"	8.15"	8.394"	70		
IS1000X300	10"	10.12"	10.38"	65		

NOTE: WORKING PRESSURE BASED ON OPERATION AT 70°F.
SERVICE TEMPERATURE RANGE FOR NU-FLO™, VINYLFLOW®, & IRONSIDES® IS 5°F TO 170°F.



GOODYEAR SPIRAFLEX® BLUE GENERAL PURPOSE LAYFLAT HOSE

This is a light-duty water discharge hose manufactured with blue PVC compound & synthetic fabric reinforcement. It should be used in applications which include irrigation, agriculture, mining, construction, industrial & for marine service. It has a service temperature range of 0°F to 150°F. It features U.V. resistance, a smooth interior, is lightweight & easy to recoil for storage. All sizes are available in 300' coils or by the foot at a increased price to cover handling.



Part No.	Nominal I.D.	Nominal O.D.	Working PSI	Price / Ft.	Price / Coil
53756404803000	1-1/2"	1.67"	90		
53756406403000	2"	2.21"	80		
53756408003000	2-1/2"	2.68"	55		
53756410703000	3"	3.20"	55		
53756412303000	4"	4.26"	50		
53756415503000	6"	6.26"	35		
53756418703000	8"	8.32"	35		

GOODYEAR SPIRAFLEX® RED GENERAL PURPOSE LAYFLAT HOSE

This is a medium-duty water discharge hose manufactured with black Pliovic® PVC tube, red Pliovic® PVC cover & spiral synthetic yarn with one layer of longitudinal synthetic yarn. It is for use in applications which include irrigation, agriculture, mining, construction, industry & marine service. It has a service temperature range of -10°F to 150°F. It features U.V. resistance & a smooth interior to minimize pressure loss due to friction. All sizes are available in 300' coils, or by the foot at a increased price to cover handling.



Part No.	Nominal I.D.	Nominal O.D.	Working PSI	Price / Ft.	Price / Coil
53752104803000	1-1/2"	1.71"	150		
53752106403000	2"	2.24"	150		
53752108003000	2-1/2"	2.79"	150		
53752110703000	3"	3.29"	125		
53752112303000	4"	4.42"	100		
53752115503000	6"	6.40"	100		

SUN-FLOW SF-50 BRICK RED GENERAL PURPOSE LAYFLAT HOSE

This is a heavy-duty water discharge hose that is designed to bridge the price & pressure gap between the cheaper - lower pressure layflat hose & the more expensive - higher pressure rubber discharge hose. Its construction is of 3-ply polyester yarns, sandwiched between PVC tube & cover, extruded simultaneously to obtain maximum bonding. Its application includes irrigation, agriculture, mines, construction & industrial uses. It has a service temperature rating of -5°F to 170°F. All sizes are available in 300' coils, or by the foot at an increased price to cover handling.



Part No.	Size	Nominal I.D.	Nominal O.D.	Working PSI	Price / Ft.	Price / Coil
SF-50-400X300	4"	4.13"	4.334"	150		
SF-50-600X300	6"	6.18"	6.418"	150		
SF-50-800X300	8"	8.19"	8.458"	115		

KIDDE - ANGUS HOSE - PREMIUM

Premium 200 hose is made in the U.S.A. and is designed for the farmer who wants the best irrigation hose available.

Application: Supply hose for irrigation travelers and linear move systems.

Composition: Nitrile rubber extruded through-the-weave.

Long term storage ability and working life. Superior resistance to ozone and ultraviolet light.

Special Rib Pattern for exceptional abrasion and cut resistance. Fully protected high tensile yarns for improved working pressure and drag. Superior kink resistance.

Part No.	Size	Nominal I.D.	Nominal O.D.	Working PSI	Coil Length	Price / Ft.	Price / Coil
AN-011175	4"	4"	4.31"	200	660'		
AN-011176	4.5"	4.5"	4.81"	200	660'		
AN-011177	5"	5"	5.31"	200	660'		



Note: WORKING PRESSURE FOR ALL HOSE LISTED ON THIS PAGE IS BASED ON OPERATION AT 70°F.

KIDDE - ANGUS HOSE - Armour Guard Heavy Duty Rubber Covered Industrial Discharge Hose

Angus Armour Guard is a layflat, flexible water discharge hose with durability and abrasion resistance superior to conventional rubber hose. Armour Guard features a unique one piece, through-the-weave construction, and attains its exceptional working pressure from a synthetic woven textile. Its excellent durability is derived from a high-tensile rubber compound which completely encases the jacket. The standard color for Armour Guard is black. Available by the foot or by the coil. Yellow hose is also available.



Part No.	Size	Bowl Size	Working PSI	Coil Length	Price / Ft.	Price / Coil
011004	1-1/2"	1-13/16"	300	660'		
011005	2"	2-3/16"	300	660'		
011006	2-1/2"	2-7/8"	300	660'		
011007	3"	3-13/32"	300	660'		
011008	4"	4-5/16"	200	660'		
011009	6"	6-3/8"	200	660'		

TEXCEL SIGMA-PVC-AQUA WATER SUCTION & DISCHARGE HOSE

Heavy-duty suction and discharge hose for use in a variety of industries, such as rental pumping equipment and applications where the hose needs to slide easily or visual confirmation of material flow is necessary.

Part No.	Nominal I.D.	Nominal O.D.	Std. Length	Working Pressure	Price
SPVC-AQUA-2.0	2"	2.62"	100'	100 PSI	
SPVC-AQUA-3.0	3"	3.71"	100'	100 PSI	
SPVC-AQUA-4.0	4"	4.80"	100'	75 PSI	
SPVC-AQUA-5.0	5"	6.05"	100'	70 PSI	
SPVC-AQUA-6.0	6"	7.17"	20' 60' 100'	70 PSI	
SPVC-AQUA-8.0	8"	9.33"	15' 20' 25'	70 PSI	



TEXCEL HEAVY-DUTY 4-PLY WATER SUCTION & DISCHARGE HOSE

Heavy-duty suction and discharge hose for use in a variety of industries, such as rental pumping equipment and applications where the hose needs to slide easily or visual confirmation of material flow is necessary.

Part No.	Nominal I.D.	Nominal O.D.	Std. Length	Working Pressure	Price
FLO-4HD-1.5	1.5"	1-57/64"	100'	250 PSI	
FLO-4HD-2.0	2"	2-25/64"	100'	250 PSI	
FLO-4HD-2.5	2.5"	2-57/64"	100'	250 PSI	
FLO-4HD-3.0	3"	3-25/64"	100'	250 PSI	
FLO-4HD-4.0	4"	4-7/16"	100'	200 PSI	
FLO-4HD-4.5	4.5"	4-15/16"	100'	200 PSI	
FLO-4HD-5	5"	5-7/16"	100'	200 PSI	
FLO-4HD-6	6"	6-7/16"	100'	200 PSI	
FLO-4HD-8	8"	8-15/32"	100'	200 PSI	
FLO-4HD-10	10"	10-17/32"	100'	150 PSI	
FLO-4HD-12	12"	12-17/32"	50'	150 PSI	



GOODYEAR SPIRAFLEX® 1500 PVC WATER SUCTION & DISCHARGE HOSE

This is a general purpose water suction & discharge hose for use in irrigation, agricultural, industrial, construction & septic tank cleaning applications. It is constructed of clear Pliovic™ flexible PVC resin with a high density green rigid Pliovic™ helix. The service temperature range is from 15°F to 158°F. All sizes are available in 100' coils, except for 8" which is only available in 60' coils. Available for purchase by the foot or by the coil.

Part No.	Nominal I.D.	Nominal O.D.	Working PSI	Price / Ft.	Price / Coil
58641202401000	3/4"	.98"	130		
58641203201000	1"	1.26"	106		
58641204001000	1-1/4"	1.53"	99		
58641204801000	1-1/2"	1.78"	89		
58641206401000	2"	2.31"	79		
58641208001000	2-1/2"	2.85"	65		
58641210701000	3"	3.38"	65		
58641212301000	4"	4.46"	55		
58641215501000	6"	6.62"	47		
58641218700600	8"	8.85"	30		



KURIYAMA TIGERFLEX BW "BLUE WATER" SUCTION & DISCHARGE HOSE

This is a multi-purpose low temperature suction & transfer hose for use in irrigation, agriculture, construction, mining & for abrasive liquid applications. It has a clear body with a blue helix & is constructed from HMW clear PVC resin to allow for visual confirmation that material is flowing. The HMW PVC body provides sub-zero flexibility & increased abrasion resistance compared to standard PVC. It is made with a smooth cover on sizes 3/4" - 4" making clamping easy, & a convoluted cover on 5" & 6" for greater flexibility. The service temperature range is -40°F to 150°F. All sizes are available in 100' coils. In addition, 5" & 6" is available in 20' lengths. Available for purchase by the foot or by the coil.

Part No.	Nominal I.D.	Nominal O.D.	Working PSI	Price / Ft.	Price / Coil
BW075X100	3/4"	1.01"	115		
BW100X100	1"	1.26"	90		
BW125X100	1-1/4"	1.56"	90		
BW150X100	1-1/2"	1.79"	90		
BW200X100	2"	2.35"	90		
BW250X100	2-1/2"	2.87"	75		
BW300X100	3"	3.43"	65		
BW400X100	4"	4.49"	55		
BW500X100	5"	5.57"	45		
BW600X100	6"	6.69"	40		



KURIYAMA TIGERFLEX TG "TIGER GREEN" EPDM SUCTION & DISCHARGE HOSE

This is a suction hose for outdoor wet or dry applications. It is constructed from black flexible EPDM rubber with a bright green polyethylene helix, providing for an excellent blend of chemical resistance & physical durability. Its features include excellent cold weather flexibility, a U.V. weather resistant exterior, a specially designed abrasion resistant helix, a smooth bore interior to eliminate material buildup, a convoluted cover design to provide increased flexibility, & it's lightweight. General applications include irrigation, agricultural, liquid & chemical, liquid waste, slurries, septic handling, water transfer, mining & construction. The service temperature range is -40°F to 160°F. All sizes available in 100' coils, or by the foot at an increased price to cover handling.

Part No.	Nominal I.D.	Nominal O.D.	Working PSI	Price / Ft.	Price / Coil
TG200X100	2"	2.51"	50		
TG300X100	3"	3.60"	45		
TG400X100	4"	4.70"	40		
TG600X100	6"	6.85"	30		



NOTE: WORKING PRESSURE FOR ALL HOSE LISTED ON THIS PAGE IS BASED ON OPERATION AT 70°F.

KURIYAMA TIGERFLEX "SPA HOSE" FMCR™ SERIES PVC SUCTION HOSE

This PVC suction hose is used in SPA, Pool and Hot Tub Plumbing Applications. It is commonly referred to as FLEX-PIPE" and can be used as a drain line. It is constructed using pvc tube with rigid pvc helix. The service temperature range is from -4° F (-20° C) to 150°F (+65°C).

Features and Advantages:

- Precision Controlled OD: Designed to be glued into Sch 40 PVC Fittings.
- IAMPO Approved: Approved for use in piping spas, hot tubs and swimming pools.
- Easy Installation: Ideal for working in confined areas. Permits installers to make smooth, tight turns.
- Requires fewer fittings than rigid pipe when plumbing a normal spa or hot tub application.

Part No.	Nominal I.D.	Nominal O.D.	Coil Length	Working Pressure @ 68°F/104°F	Price / Ft.	Price / Coil
F16MCRx***	1/2"	.85"	100/50	100 / 70		
F20MCRx***	3/4"	1.053"	100/50	100 / 70		
F27MCRx***	1"	1.32"	100/50	100 / 70		
F36MCRx***	1-1/4"	1.663"	100/50	80 / 55		
F42MCRx***	1-1/2"	1.904"	100/50	70 / 50		
F52MCRx***	2"	2.381"	100/50	70 / 50		
F78MCRx50	3"	3.50"	50	65 / 40		



*NOT IAMPO LISTED
 *** (Please SPECIFY COIL LENGTH)

KURIYAMA TIGERFLEX SERIES H HOSE

Features and Advantages:

This hose has many purposes and applications. Characteristics Include: Transparent construction so you have visual confirmation of material. Flow, smooth outer cover (3/4" - 5") which provides increased pressure rating and smooth surface for banding, the 6" and 8" sizes have a convoluted outer cover providing increased hose flexibility. The hose is constructed of PVC tube with rigid PVC Helix.

General Applications:

Agricultural liquid fertilizer, air seeder lines, drain lines, irrigation lines, pumps (rental and construction dewatering), pumps (trash), rock dusting, water suction (standard duty). Service temperatures range from -4°F to 150°F.

Part No.	Nominal I.D.	Nominal O.D.	Coil Length	Working Pressure @ 68°F/104°F	Price / Ft.	Price / Coil
H075	3/4"	1.01"	100'	110 / 70		
H100	1"	1.26"	100'	85 / 60		
H125	1-1/4"	1.56"	100'	85 / 60		
H150	1-1/2"	1.83"	100'	70 / 50		
H200	2"	2.32"	100'	65 / 45		
H250	2-1/2"	2.87"	100'	65 / 45		
H300	3"	3.43"	100'	60 / 40		
H400	4"	4.5"	100'	50 / 35		
H500	5"	5.58"	100'/20'	45 / 30		
H600	6"	6.75"	100'/20'	40 / 25		
H800	8"	8.86"	20'	30 / 20		



INTRO
 1. ELECTRICAL
 2. PUMP Acc.
 3. HOSE: PE Pipe & Acc.
 4. IPS: PIP Pipe & Acc.
 5. SURFACE
 6. SPRINKLERS
 7. TRAVELER & WHEEL MOVE
 8. PIVOT
 9. TURF
 10. LOW VOLUME
 11. FILTERS
 12. INJECTION
 13. HARDWARE
 INDEX

GOODYEAR NUTRIFLO® FOOD TRANSFER SUCTION & DISCHARGE HOSE

This hose is for handling every type of dry bulk food material or liquid in gravity flow & vacuum service. Nutriflo® conforms to USDA Meat & Poultry, 3-A Sanitary, & FDA standards & is used for the transmission of raw & pasteurized milk & other high water content dairy items. It is constructed of clear Pliovic® (FDA, 3-A, USDA Compliant, NSF-61) tube & cover, & a clear high density Pliovic® helix reinforcement. The service temperature range is -15°F to 158°F. All sizes are available in 100' coils, and may be purchased by the foot or by the coil.



Part No.	Nominal I.D.	Nominal O.D.	Working PSI	Price / Ft.	Price / Coil
58642104801000	1-1/2"	1.78"	89		
58642106401000	2"	2.37"	79		
58642110701000	3"	3.48"	65		
58642112301000	4"	4.50"	55		

GOODYEAR PLICORD® "CON-AG" WATER SUCTION & DISCHARGE HOSE

This is a general purpose water suction & discharge hose for applications in medium or heavy-duty operations such as irrigation, agriculture or construction. The tube is constructed of black Versigard® synthetic rubber. The reinforcement is of a spiral plied synthetic fabric with wire helix, and the cover is of black Versigard® synthetic rubber (wrapped finish) with yellow spiral stripe. The service temperature range is -40°F to 180°F. All sizes are available in 100' coils, and may be purchased by the foot or by the coil.



Part No.	Nominal I.D.	Nominal O.D.	Working PSI	Price / Ft.	Price / Coil
54215904001000	1-1/4"	1.69"	125		
54215904801000	1-1/2"	1.93"	125		
54215906401000	2"	2.45"	125		
54215908001000	2-1/2"	3.02"	100		
54215910701000	3"	3.51"	100		
54215912301000	4"	4.55"	75		
54215915501000	6"	6.61"	75		

KURIYAMA ALFAGOMMA® WATER SUCTION & DISCHARGE HOSE

This is a multi-purpose water suction & discharge hose for delivery of non-corrosive liquids for irrigation & construction. Model T202AA, sizes 2", 3" & 4", is manufactured from black EPDM rubber, & as such will accept fertilizers & lasso acid solutions. Models T203AA & T204AA, sizes 6", 8", 10" & 12", are manufactured with black SBR rubber. Each features a spiralled high tensile textile cord & flexible helix wire reinforcement. This hose is weather & ozone resistant. The service temperature range is -22°F to 176°F. Available for purchase by the foot or by the coil.



Part No.	Nom. I.D.	Nom. O.D.	Working PSI	Coil Length	Price / Ft.	Price / Coil
T202AA200X100	2"	2.40"	150	100'		
T202AA300X100	3"	3.46"	150	100'		
T202AA400X100	4"	4.49"	150	100'		
T204AA600X25	6"	6.54"	75	25'		
T204AA600X50	6"	6.54"	75	50'		
T204AA600X100	6"	6.54"	75	100'		
T204AA800X25	8"	8.70"	75	25'		
T203AA1000X20	10"	10.71"	150	20'		
T203AA1200X20	12"	12.87"	150	20'		

KURIYAMA ALFAGOMMA® BLACK PETROLEUM SUCTION & DISCHARGE HOSE

This hose is for suction & discharge applications in truck & tank car transfer of gasoline, oil & other petroleum based products with up to 50% aromatic content. The hose construction is of black conductive NBR for the tube, high tensile textile cord and 4 highly flexible steel helix wire reinforcement, and abrasion and ozone resistant black nitrile PVC for the cover. The service temperature range is -40°F to 212°F. All sizes are available in 100' coils, and may be purchased by the foot or by the coil.



Part No.	Nominal I.D.	Nominal O.D.	Working PSI	Price / Ft.	Price / Coil
T605AA200X100	2"	2.44"	150		
T605AA300X100	3"	3.46"	150		

NOTE: WORKING PSI BASED ON 70°F.

BRASS PLAIN HOSE NOZZLES

Part No.	Size	Thread	Length	Orifice	Price
BN6	3/4"	GHT	6"	1/4"	
BN10	1"	NPSH	8"	5/16"	
BN12	1-1/4"	NPSH	10"	3/8"	
BN15	1-1/2"	NPSH	10"	1/2"	
BN20	2"	NPSH	12"	9/16"	
BN25	2-1/2"	NPSH	12"	1"	



FANSHOT™ & FANSHOT™ PLUS WITH FLOW REGULATOR

Part No.	Size	Flow @ 125 PSI	Thread	Description	Price
DN100FS20	1"	20 GPM	NPSH	FanShot™ Syringe Hose Noz.	
DN100FS30	1"	30 GPM	NPSH	FanShot™ Syringe Hose Noz.	
DN075FSP10	3/4"	10 GPM	GHT	FanShot™ Plus Noz. w/ Reg.	
DN075FSP20	3/4"	20 GPM	GHT	FanShot™ Plus Noz. w/ Reg.	
DN075FSP30	3/4"	30 GPM	GHT	FanShot™ Plus Noz. w/ Reg.	
DN100FSP10	1"	10 GPM	NPSH	FanShot™ Plus Noz. w/ Reg.	
DN100FSP20	1"	20 GPM	NPSH	FanShot™ Plus Noz. w/ Reg.	
DN100FSP30	1"	30 GPM	NPSH	FanShot™ Plus Noz. w/ Reg.	



COOLSHOT™ & COOLSHOT™ PLUS WITH FLOW REGULATOR

Part No.	Size	Thread	Description	Price
DN075CS	3/4"	GHT	CoolShot™ Shower Noz. for Syringing	
DN100CS	1"	NPSH	CoolShot™ Shower Noz. for Syringing	
DN075CSP	3/4"	GHT	CoolShot™ Plus Nozzle w/ Regulator	
DN100CSP	1"	NPSH	CoolShot™ Plus Nozzle w/ Regulator	
DN075CSPE	3/4"	GHT	CoolShot™ Plus Economy Noz. w/ Reg.	
DN100CSPE	1"	NPSH	CoolShot™ Plus Economy Noz. w/ Reg.	



HOTSHOT™ MULTI PATTERN HOSE NOZZLE WITH FLOW REGULATOR

Part No.	Size	Thread	Description	Price
DN075HSM	3/4"	GHT	HotShot™ Hose Nozzle w/ Regulator	
DN100HSM	1"	NPSH	HotShot™ Hose Nozzle w/ Regulator	



THERMOPLASTIC FOG NOZZLES

Part No.	Size	Thread	Spray	GPM @ 100PSI	Price
FNB75GHT	3/4"	GHT	120°	30.9	
FNB100S	1"	NPSH	90°	11.4	
FNB150S	1-1/2"	NPSH	90°	83.6	



INTRO
 1. ELECTRICAL
 2. PUMP Acc.
 3. HOSE, PE PIPE & Acc.
 4. IPS, PIP Pipe & Acc.
 5. SURFACE
 6. SPRINKLERS
 7. TRAVELER & WHEEL MOVE
 8. PIVOT
 9. TURF
 10. LOW VOLUME
 11. FILTERS
 12. INJECTION
 13. HARDWARE
 INDEX

HOSE THREAD SHUT-OFF VALVES



SINGLE METAL SHUT-OFF

05V - Rugged zinc die cast.
AS1FFM (pictured) - Heavy-duty aluminum has 45% more water flow.

Part No.	Size	Price
05V	3/4" GHT	
AS1FFM	3/4" GHT	



DOUBLE METAL "Y" SHUT-OFF

15 - Rugged zinc die cast.
AY2FFM (pictured) - Heavy-duty aluminum has 45% more water flow.

Part No.	Size	Price
15	3/4" GHT	
AY2FFM	3/4" GHT	



FOUR WAY ALUMINUM SHUT-OFF

Controls water flow to specific areas.
Extra large handles for easier on / off operation.
Has 45% more water flow than other models.

Part No.	Size	Price
AY4FFM	3/4" GHT	



SINGLE PLASTIC SHUT-OFF

Two great shut-off valves.
However AS1FF (pictured) has 45% more water flow.

Part No.	Size	Price
07V	3/4" GHT	
AS1FF	3/4" GHT	



DOUBLE PLASTIC "Y" SHUT-OFF

Two great shut-off valves.
However AY2FF (pictured) has 45% more water flow.

Part No.	Size	Price
17	3/4" GHT	
AY2FF	3/4" GHT	



FOUR WAY PLASTIC SHUT-OFF

Controls water flow to specific areas.
Extra large handles for easier on / off operation.
Has 45% more water flow than other models.

Part No.	Size	Price
AY4FF	3/4" GHT	

HOSE THREAD FULL FLOW QUICK CONNECTORS

- Connectors for quick & easy attachment & removal of hose to faucet.
- 45% More water flow compared to similar connectors.
- Durable rustproof polymer construction.



FAUCET CONNECTOR SET

Part No.	Size	Price
39QFF	3/4" MHT/FHT	



FEMALE FAUCET CONNECTOR

Part No.	Size	Price
39QFFF	3/4" MHT	



MALE FAUCET CONNECTOR

Part No.	Size	Price
39QMFF	3/4" FHT	



MALE HOSE END QUICK CONNECTORS

Part No.	Size	Price
29QMFF	3/4" MHT	

COUPLINGS & MENDERS



MALE HOSE THREAD COUPLING

Part No.	Hose Size	Price
01MZ	5/8" & 3/4"	



FEMALE HOSE THREAD COUPLING

Part No.	Hose Size	Price
01FZ	5/8" & 3/4"	



HOSE MENDER

Part No.	Hose Size	Price
01HMZ	5/8" & 3/4"	



MALE HOSE THREAD COUPLING

Part No.	Hose Size	Price
01M	5/8" & 3/4"	



FEMALE HOSE THREAD COUPLING

Part No.	Hose Size	Price
01F	5/8" & 3/4"	



HOSE MENDER

Part No.	Hose Size	Price
01HM	5/8" & 3/4"	



MALE HOSE THREAD COUPLING

Part No.	Hose Size	Price
05M	1/2"	



FEMALE HOSE THREAD COUPLING

Part No.	Hose Size	Price
05F	1/2"	



HOSE MENDER

Part No.	Hose Size	Price
05HM	1/2"	

BRASS HOSE REPAIR COUPLINGS & MENDERS



MALE HOSE THREAD COUPLING

Part No.	Hose Size	Price
C12M	1/2"	
C58M	5/8"	
C34M	3/4"	



FEMALE HOSE THREAD COUPLING

Part No.	Hose Size	Price
C12F	1/2"	
C58F	5/8"	
C34F	3/4"	



HOSE MENDER

Part No.	Hose Size	Price
C12HM	1/2"	
C58HM	5/8"	
C34HM	3/4"	

INTRO 1. ELECTRICAL 2. PUMP Acc. 3. HOSE, PE PIPE & Acc. 4. IPS, PIP Pipe & Acc. 5. SURFACE 6. SPRINKLERS 7. TRAVELER & WHEEL MOVE 8. PIVOT 9. TURF 10. LOW VOLUME 11. FILTERS 12. INJECTION 13. HARDWARE INDEX

BRASS HOSE THREAD COUPLINGS, FITTINGS & ADAPTERS



MALE COUPLING

Part No.	Size	Price
BCM74	1/2"	
BCM75	5/8"	
BCM76	3/4"	
BS818	1"	

Note: 1" Couplings have NPSM Threads



FEMALE COUPLING W/ SWIVEL NUT

Part No.	Size	Price
BCF74	1/2"	
BCF75	5/8"	
BCF76	3/4"	
BS848	1"	



GARDEN HOSE CAP

Part No.	Size	Price
HECB	GHT	



CAST COUPLING SET

Part No.	Size	Price
BRGHT050	1/2"	
BRGHT062	5/8"	
BRGHT075	3/4"	
BRGHT100	1"	



HOSE BARB X MALE

Part No.	Size	Price
BN46	1/2" HB x 3/4" NPT	
BN56	5/8" HB x 3/4" NPT	
BN66	3/4" HB x 3/4" NPT	
BN86	1" HB x 3/4" NPT	
BN88	1" HB x 1" NPT	



HYDRANT ADAPTER WITH PIN LUGS

Part No.	Size	Price
HA1576	GHT x 1-1/2" NST	
HA2576	GHT x 2-1/2" NST	
HA1510T	1" NPT x 1-1/2" NST	
HA2510T	1" NPT x 2-1/2" NST	
HA2520T	2" NPT x 2-1/2" NST	

BRASS HOSE THREAD COUPLINGS, FITTINGS & ADAPTERS



MALE X MALE

Part No.	Size	Price
HPF6	GHT x GHT	
HPF10*	GHT x 1/2" NPT	
HPF8*	GHT x 3/4" NPT	
509-1612	GHT x 1" NPSH	
HPF19**	1" NPSH x 1" NPT	
DMH1515F	1-1/2" NH x 1-1/2" NPT	

*Note: 1/2" Female NPT Inside 3/4" Male NPT

**Note: 3/4" Female NPT Inside 1" Male NPT



SWIVEL FEMALE X FEMALE

Part No.	Size	Price
HPF7	GHT x GHT	
HPF13	GHT x 1/2" NPT	
HPF12	GHT x 3/4" NPT	



MALE GHT X FEMALE

Part No.	Size	Price
BA794	GHT x 1/2" NPT	
BA796	GHT x 3/4" NPT	
FM1076	GHT x 1" NPT	
HPF17	GHT x 1" NPSH	



RIGID FEMALE X FEMALE

Part No.	Size	Price
41052	GHT x 1/4" NPT	
BA974	GHT x 1/2" NPT	
BA976	GHT x 3/4" NPT	



SWIVEL FEMALE GHT X MALE

Part No.	Size	Price
HPF5	GHT x 1/4" NPT	
504-1208	GHT x 1/2" NPT	
504-1212	GHT x 3/4" NPT	



RIGID FEMALE GHT X MALE

Part No.	Size	Price
BMA974	GHT x 1/2" NPT	
BMA976	GHT x 3/4" NPT	
FM7610T	GHT x 1" NPT	

INTRO
 1. ELECTRICAL
 2. PUMP Acc.
 3. HOSE, PE Pipe & Acc.
 4. IPS, PIP Pipe & Acc.
 5. SURFACE
 6. SPRINKLERS
 7. TRAVELER & WHEEL MOVE
 8. PIVOT
 9. TURN
 10. LOW VOLUME
 11. FILTERS
 12. INJECTION
 13. HARDWARE
 INDEX

BANJO® GARDEN HOSE QUICK-ACTING FITTINGS

Features

- Quick and simple way to connect and disconnect your garden hose
- Easily connects hose to spigot, sprinkler, nozzle or other hose end accessories
- Durable, rustproof polypropylene construction
- Never have to use pliers to tighten to prevent leaks
- Yellow fiberglass reinforced polypropylene
- Standard 3/4" opening diameter



MALE ADAPTER X FEMALE HOSE THREAD

Part No.	Description	Price
GHFT075A	3/4" Adapter x 3/4" Garden Hose Female Thread	



FEMALE COUPLER X MALE HOSE THREAD

Part No.	Description	Price
GHMT075B	3/4" Coupler x 3/4" Garden Hose Male Thread	



FEMALE COUPLER X FEMALE HOSE THREAD

Part No.	Description	Price
GHFT075D	3/4" Coupler x 3/4" Garden Hose Female Thread	



MALE ADAPTER X MALE HOSE THREAD

Part No.	Description	Price
GHMT075F	3/4" Adapter x 3/4" Garden Hose Male Thread	



MALE PIPE THREAD X FEMALE HOSE THREAD

Part No.	Description	Price
GHFT075MPT	3/4" Male NPT x 3/4" Garden Hose Female Thread	



FEMALE PIPE THREAD X MALE HOSE THREAD

Part No.	Description	Price
GHMT075FPT	3/4" Female NPT x 3/4" Garden Hose Male Thread	

POLYPROPYLENE QUICK-ACTING FITTINGS



**TYPE A -
Male Adapter x FIPT**

Part No.	Size	Price
75A1/2	1/2" x 1/2"	
75A3/4	3/4"	
100A	1"	
125A	1-1/4"	
150A	1-1/2"	
200A	2"	
300A	3"	
400A	4"	



**TYPE B -
Female Coupler x MIPT**

Part No.	Size	Price
75B1/2	1/2" x 1/2"	
75B3/4	3/4"	
100B	1"	
125B	1-1/4"	
150B	1-1/2"	
200B	2"	
300B	3"	
400B	4"	



**TYPE C -
Female Coupler x Hose Shank**

Part No.	Size	Price
050C	1/2" x 1/2"	
075C	3/4"	
100C	1"	
125C	1-1/4"	
150C	1-1/2"	
200C	2"	
300C	3"	
400C	4"	



**TYPE D -
Female Coupler x FIPT**

Part No.	Size	Price
050D	1/2" x 1/2"	
075D	3/4"	
100D	1"	
125D	1-1/4"	
150D	1-1/2"	
200D	2"	
300D	3"	
400D	4"	



**TYPE E -
Male Adapter x Hose Shank**

Part No.	Size	Price
050E	1/2" x 1/2"	
075E	3/4"	
100E	1"	
125E	1-1/4"	
150E	1-1/2"	
200E	2"	
300E	3"	
400E	4"	



**TYPE F -
Male Adapter x MIPT**

Part No.	Size	Price
050F	1/2" x 1/2"	
075F	3/4"	
100F	1"	
125F	1-1/4"	
150F	1-1/2"	
200F	2"	
300F	3"	
400F	4"	



**TYPE DC -
Dust Cap**

Part No.	Size	Price
075CAP	1/2" x 1/2"	
075CAP	3/4"	
100125CAP	1"	
100125CAP	1-1/4"	
150CAP	1-1/2"	
200CAP	2"	
300CAP	3"	
400CAP	4"	



**TYPE DP -
Dust Plug**

Part No.	Size	Price
75PL	1/2" x 1/2"	
75PL	3/4"	
100125PL	1"	
100125PL	1-1/4"	
150PL	1-1/2"	
200PL	2"	
300PL	3"	
400PL	4"	



**TYPE A90 -
90° Male Adapter x FIPT**

Part No.	Size	Price
150A90	1-1/2"	
200A90	2"	



**TYPE C90 -
90° Female Coupler x Hose Shank**

Part No.	Size	Price
150C90	1-1/2"	
200C90	2"	



**TYPE D90 -
90° Female Coupler x FIPT**

Part No.	Size	Price
150D90	1-1/2"	
200D90	2"	



**TYPE F90 -
90° Male Adapter x MIPT**

Part No.	Size	Price
150F90	1-1/2"	
200F90	2"	

INTRO 1. ELECTRICAL 2. PUMP Acc. 3. HOSE, PE Pipe & Acc. 4. IPS, PIP Pipe & Acc. 5. SURFACE 6. SPRINKLERS 7. TRAVELER & WHEEL MOVE 8. PIVOT 9. TURN 10. LOW VOLUME 11. FILTERS 12. INJECTION 13. HARDWARE INDEX

ALUMINUM QUICK-ACTING FITTINGS



**TYPE A -
Male Adapter x FIPT**

Part No.	Size	Price
AL-A050	1/2" x 1/2"	
AL-A075	3/4"	
AL-A100	1"	
AL-A125	1-1/4"	
AL-A150	1-1/2"	
AL-A200	2"	
AL-A250	2-1/2"	
AL-A300	3"	
AL-A400	4"	
AL-A600	6"	
AL-A800	8"	



**TYPE B -
Female Coupler x MIPT**

Part No.	Size	Price
AL-B050	1/2" x 1/2"	
AL-B075	3/4"	
AL-B100	1"	
AL-B125	1-1/4"	
AL-B150	1-1/2"	
AL-B200	2"	
AL-B250	2-1/2"	
AL-B300	3"	
AL-B400	4"	
AL-B600	6"	
800-B-AL	8"	



**TYPE C -
Female Coupler x Hose Shank**

Part No.	Size	Price
AL-C050	1/2" x 1/2"	
AL-C075	3/4"	
AL-C100	1"	
AL-C125	1-1/4"	
AL-C150	1-1/2"	
AL-C200	2"	
AL-C250	2-1/2"	
AL-C300	3"	
AL-C400	4"	
AL-C600	6"	
AL-C800	8"	



**TYPE D -
Female Coupler x FIPT**

Part No.	Size	Price
AL-D050	1/2" x 1/2"	
AL-D075	3/4"	
AL-D100	1"	
AL-D125	1-1/4"	
AL-D150	1-1/2"	
AL-D200	2"	
AL-D250	2-1/2"	
AL-D300	3"	
AL-D400	4"	
AL-D600	6"	
AL-D800	8"	



**TYPE E -
Male Adapter x Hose Shank**

Part No.	Size	Price
AL-E050	1/2" x 1/2"	
AL-E075	3/4"	
AL-E100	1"	
AL-E125	1-1/4"	
AL-E150	1-1/2"	
AL-E200	2"	
AL-E250	2-1/2"	
AL-E300	3"	
AL-E400	4"	
AL-E600	6"	
AL-E800	8"	



**TYPE F -
Male Adapter x MIPT**

Part No.	Size	Price
AL-F050	1/2" x 1/2"	
AL-F075	3/4"	
AL-F100	1"	
AL-F125	1-1/4"	
AL-F150	1-1/2"	
AL-F200	2"	
AL-F250	2-1/2"	
AL-F300	3"	
AL-F400	4"	
AL-F600	6"	
800-F-AL	8"	



**TYPE DC -
Dust Cap**

Part No.	Size	Price
AL-DC050	1/2" x 1/2"	
AL-DC075	3/4"	
AL-DC100	1"	
AL-DC125	1-1/4"	
AL-DC150	1-1/2"	
AL-DC200	2"	
AL-DC250	2-1/2"	
AL-DC300	3"	
AL-DC400	4"	
AL-DC600	6"	
AL-DC800	8"	



**TYPE DP -
Dust Plug**

Part No.	Size	Price
AL-DP050	1/2" x 1/2"	
AL-DP075	3/4"	
AL-DP100	1"	
AL-DP125	1-1/4"	
AL-DP150	1-1/2"	
AL-DP200	2"	
AL-DP250	2-1/2"	
AL-DP300	3"	
AL-DP400	4"	
AL-DP600	6"	
800-DP-AL	8"	



**TYPE D X A -
Reducing Coupler / Adapter**

Part No.	Size	Price
RDA-A2030	2" x 3"	
RDA-A3020	3" x 2"	
RDA-A3040	3" x 4"	
RDA-A4020	4" x 2"	
RDA-A4030	4" x 3"	
RDA-A6040	6" x 4"	

Note: Dust caps & dust plugs are not designed for pressure applications.

TYPE 304 STAINLESS STEEL QUICK-ACTING FITTINGS



**TYPE A -
Male Adapter x FIPT**

Part No.	Size	Price
SS304-A050	1/2" x 1/2"	
SS304-A075	3/4"	
SS304-A100	1"	
SS304-A125	1-1/4"	
SS304-A150	1-1/2"	
SS304-A200	2"	
SS304-A250	2-1/2"	
SS304-A300	3"	
SS304-A400	4"	
SS304-A500	5"	
SS304-A600	6"	



**TYPE B -
Female Coupler x MIPT**

Part No.	Size	Price
SS304-B050	1/2" x 1/2"	
SS304-B075	3/4"	
SS304-B100	1"	
SS304-B125	1-1/4"	
SS304-B150	1-1/2"	
SS304-B200	2"	
SS304-B250	2-1/2"	
SS304-B300	3"	
SS304-B400	4"	
SS304-B500	5"	
SS304-B600	6"	



**TYPE C -
Female Coupler x Hose Shank**

Part No.	Size	Price
SS304-C050	1/2" x 1/2"	
SS304-C075	3/4"	
SS304-C100	1"	
SS304-C125	1-1/4"	
SS304-C150	1-1/2"	
SS304-C200	2"	
SS304-C250	2-1/2"	
SS304-C300	3"	
SS304-C400	4"	
SS304-C500	5"	
SS304-C600	6"	



**TYPE D -
Female Coupler x FIPT**

Part No.	Size	Price
SS304-D050	1/2" x 1/2"	
SS304-D075	3/4"	
SS304-D100	1"	
SS304-D125	1-1/4"	
SS304-D150	1-1/2"	
SS304-D200	2"	
SS304-D250	2-1/2"	
SS304-D300	3"	
SS304-D400	4"	
SS304-D500	5"	
SS304-D600	6"	



**TYPE E -
Male Adapter x Hose Shank**

Part No.	Size	Price
SS304-E050	1/2" x 1/2"	
SS304-E075	3/4"	
SS304-E100	1"	
SS304-E125	1-1/4"	
SS304-E150	1-1/2"	
SS304-E200	2"	
SS304-E250	2-1/2"	
SS304-E300	3"	
SS304-E400	4"	
SS304-E500	5"	
SS304-E600	6"	



**TYPE F -
Male Adapter x MIPT**

Part No.	Size	Price
SS304-F050	1/2" x 1/2"	
SS304-F075	3/4"	
SS304-F100	1"	
SS304-F125	1-1/4"	
SS304-F150	1-1/2"	
SS304-F200	2"	
SS304-F250	2-1/2"	
SS304-F300	3"	
SS304-F400	4"	
SS304-F500	5"	
SS304-F600	6"	



**TYPE DC -
Dust Cap**

Part No.	Size	Price
SS304-DC050	1/2" x 1/2"	
SS304-DC075	3/4"	
SS304-DC100	1"	
SS304-DC125	1-1/4"	
SS304-DC150	1-1/2"	
SS304-DC200	2"	
SS304-DC250	2-1/2"	
SS304-DC300	3"	
SS304-DC400	4"	
SS304-DC500	5"	
SS304-DC600	6"	



**TYPE DP -
Dust Plug**

Part No.	Size	Price
SS304-DP050	1/2" x 1/2"	
SS304-DP075	3/4"	
SS304-DP100	1"	
SS304-DP125	1-1/4"	
SS304-DP150	1-1/2"	
SS304-DP200	2"	
SS304-DP250	2-1/2"	
SS304-DP300	3"	
SS304-DP400	4"	
SS304-DP600	6"	



**TYPE D X A -
Reducing Coupler / Adapter**

Part No.	Size	Price
RDA-SS3020	3" x 2"	
RDA-SS4030	4" x 3"	
RDA-SS6040	6" x 4"	

INTRO | 1. ELECTRICAL | 2. PUMP ACC. | 3. HOSE, PE PIPE & ACC. | 4. IPS, PIP PIPE & ACC. | 5. SURFACE | 6. SPRINKLERS | 7. TRAVELER & WHEEL MOVE | 8. PIVOT | 9. TURN | 10. LOW VOLUME | 11. FILTERS | 12. INJECTION | 13. HARDWARE | INDEX

CAM LEVER FITTINGS

TYPE 316 STAINLESS STEEL QUICK-ACTING FITTINGS



**TYPE A -
Male Adapter x FIPT**

Part No.	Size	Price
SS-A050	1/2" x 1/2"	
SS-A075	3/4"	
SS-A100	1"	
SS-A125	1-1/4"	
SS-A150	1-1/2"	
SS-A200	2"	
SS-A250	2-1/2"	
SS-A300	3"	
SS-A400	4"	
SS-A500	5"	
SS-A600	6"	



**TYPE B -
Female Coupler x MIPT**

Part No.	Size	Price
SS-B050	1/2" x 1/2"	
SS-B075	3/4"	
SS-B100	1"	
SS-B125	1-1/4"	
SS-B150	1-1/2"	
SS-B200	2"	
SS-B250	2-1/2"	
SS-B300	3"	
SS-B400	4"	
SS-B500	5"	
SS-B600	6"	



**TYPE C -
Female Coupler x Hose Shank**

Part No.	Size	Price
SS-C050	1/2" x 1/2"	
SS-C075	3/4"	
SS-C100	1"	
SS-C125	1-1/4"	
SS-C150	1-1/2"	
SS-C200	2"	
SS-C250	2-1/2"	
SS-C300	3"	
SS-C400	4"	
SS-C500	5"	
SS-C600	6"	



**TYPE D -
Female Coupler x FIPT**

Part No.	Size	Price
SS-D050	1/2" x 1/2"	
SS-D075	3/4"	
SS-D100	1"	
SS-D125	1-1/4"	
SS-D150	1-1/2"	
SS-D200	2"	
SS-D250	2-1/2"	
SS-D300	3"	
SS-D400	4"	
SS-D500	5"	
SS-D600	6"	



**TYPE E -
Male Adapter x Hose Shank**

Part No.	Size	Price
SS-E050	1/2" x 1/2"	
SS-E075	3/4"	
SS-E100	1"	
SS-E125	1-1/4"	
SS-E150	1-1/2"	
SS-E200	2"	
SS-E250	2-1/2"	
SS-E300	3"	
SS-E400	4"	
SS-E500	5"	
SS-E600	6"	



**TYPE F -
Male Adapter x MIPT**

Part No.	Size	Price
SS-F050	1/2" x 1/2"	
SS-F075	3/4"	
SS-F100	1"	
SS-F125	1-1/4"	
SS-F150	1-1/2"	
SS-F200	2"	
SS-F250	2-1/2"	
SS-F300	3"	
SS-F400	4"	
SS-F500	5"	
SS-F600	6"	



**TYPE DC -
Dust Cap**

Part No.	Size	Price
SS-DC050	1/2" x 1/2"	
SS-DC075	3/4"	
SS-DC100	1"	
SS-DC125	1-1/4"	
SS-DC150	1-1/2"	
SS-DC200	2"	
SS-DC250	2-1/2"	
SS-DC300	3"	
SS-DC400	4"	
SS-DC500	5"	
SS-DC600	6"	



**TYPE DP -
Dust Plug**

Part No.	Size	Price
SS-DP050	1/2" x 1/2"	
SS-DP075	3/4"	
SS-DP100	1"	
SS-DP125	1-1/4"	
SS-DP150	1-1/2"	
SS-DP200	2"	
SS-DP250	2-1/2"	
SS-DP300	3"	
SS-DP400	4"	
SS-DP600	6"	

POLYPROPYLENE HOSE BARB FITTINGS

FEATURES

- Precision molded in polypropylene
- Glass reinforced for stability, strength and toughness
- Hose barbs are molded specifically to fit properly into hoses

- Combination sizes available for elbows and straight barbs
- Excellent chemical resistance
- Pressure to 150 PSI at 70° F

POLY STRAIGHT HOSE BARB (MIPT X HOSE BARB)

Part No.	Size	Price
HB025	1/4" x 1/4"	
HB025-038	1/4" x 3/8"	
HB025-050	1/4" x 1/2"	
HB038	3/8" x 3/8"	
HB038-050	3/8" x 1/2"	
HB050-038	1/2" x 3/8"	
HB050	1/2" x 1/2"	
HB050-075	1/2" x 3/4"	
HB075-038	3/4" x 3/8"	
HB075-050	3/4" x 1/2"	
HB075-058	3/4" x 5/8"	
HB075	3/4" x 3/4"	
HB075-100	3/4" x 1"	
HB100-075	1" x 3/4"	
HB100	1" x 1"	
HB100-125	1" x 1-1/4"	
HB125-075	1-1/4" x 3/4"	
HB125-100	1-1/4" x 1"	
HB125	1-1/4" x 1-1/4"	
HB125-150	1-1/4" x 1-1/2"	
HB150-100	1-1/2" x 1"	
HB150-125	1-1/2" x 1-1/4"	
HB150	1-1/2" x 1-1/2"	
HB150-200	1-1/2" x 2"	
HB200-150	2" x 1-1/2"	
HB200	2" x 2"	
HB300	3" x 3"	
HB400	4" x 4"	



POLY HOSE BARB THREADED TEE (BARB X BARB X MIPT)

Part No.	Size	Price
HBT100-100	1" x 1" x 1"	
HBT150-100	1-1/2" x 1-1/2" x 1"	
HBT150-150	1-1/2" x 1-1/2" x 1-1/2"	



POLY ELBOW 90° (HOSE BARB)

Part No.	Size	Price
HBEL100-90	1" x 1"	



POLY ELBOW 90° (HOSE BARB X MIPT)

Part No.	Size	Price
HBEL150/100-90	1-1/2" x 1"	



POLY 90° HOSE BARB (MIPT X BARB)

Part No.	Size	Price
HB025-90	1/4" x 1/4"	
HB025/038-90	1/4" x 3/8"	
HB025/050-90	1/4" x 1/2"	
HB038-90	3/8" x 3/8"	
HB050/038-90	1/2" x 3/8"	
HB050-90	1/2" x 1/2"	
HB050/075-90	1/2" x 3/4"	
HB075/050-90	3/4" x 1/2"	
HB075-90	3/4" x 3/4"	
HB075/100-90	3/4" x 1"	
HB100/075-90	1" x 3/4"	
HB100-90	1" x 1"	
HB100/125-90	1" x 1-1/4"	
HB125/100-90	1-1/4" x 1"	
HB125-90	1-1/4" x 1-1/4"	
HB125/150-90	1-1/4" X 1-1/2"	
HB150/125-90	1-1/2" x 1-1/4"	
HB150-90	1-1/2" x 1-1/2"	
HB200/150-90	2" x 1-1/2"	
HB200-90	2" x 2"	
HB300-90	3" x 3"	



POLY FEMALE HOSE BARB (FIPT X HOSE BARB)

Part No.	Size	Price
HBF075	3/4" x 3/4"	
HBF075-100	3/4" x 1"	
HBF100	1" x 1"	



POLY HOSE BARB TEE (BARB X BARB X BARB)

Part No.	Size	Price
HBT050-038	1/2" x 1/2" x 3/8"	
HBT050-075	1/2" x 1/2" x 3/4"	
HBT075-050	3/4" x 3/4" x 1/2"	
HBT075	3/4" x 3/4" x 3/4"	
HBT075-100	3/4" x 3/4" x 1"	
HBT100-075	1" x 1" x 3/4"	
HBT100	1" x 1" x 1"	



POLY HOSE MENDER (BARB X BARB)

Part No.	Size	Price
HM050	1/2" x 1/2"	
HM075	3/4" x 3/4"	
HM100	1" x 1"	
HM125	1-1/4" x 1-1/4"	
HM150	1-1/2" x 1-1/2"	
HM200	2" x 2"	
HM300	3" x 3"	



INTRO
1. ELECTRICAL
2. PUMP Acc.
3. HOSE, PE PIPE & Acc.
4. IPS, PIP Pipe & Acc.
5. SURFACE
6. SPRINKLERS
7. TRAVELER & WHEEL MOVE
8. PIVOT
9. TURF
10. LOW VOLUME
11. FILTERS
12. INJECTION
13. HARDWARE
INDEX

HOSE BARB KING NIPPLES & MENDERS

HOSE BARB KING COMBINATION NIPPLES - MALE PIPE THREAD END

Size	Black Steel		Plated Steel		316 Stainless Steel	
	Part No.	Price	Part No.	Price	Part No.	Price
1/2"	STN050		SPN050		SSN050	
3/4"	STN075		SPN075		SSN075	
1"	STN100		SPN100		SSN100	
1-1/4"	STN125		SPN125		SSN125	
1-1/2"	STN150		SPN150		SSN150	
2"	STN200		SPN200		SSN200	
2-1/2"	STN250		SPN250		SSN250	
3"	STN300		SPN300		SSN300	
4"	STN400		SPN400		SSN400	
5"	STN500		STC50		SSN500	
6"	STN600		SPN600		SSN600	
8"	ST80		SPN800		RST80	



HOSE BARB KING COMBINATION NIPPLES - GROOVED END

Size	Black Steel		316 Stainless Steel	
	Part No.	Price	Part No.	Price
1-1/2"	STV20		RSTV20	
2"	STV25		RSTV25	
2-1/2"	STV30		-	
3"	STV35		300KCGV	
4"	STV40		400KCGV	
5"	STV50		-	
6"	STV60		600KCGV	
8"	STV80		-	



HOSE BARB KING COMBINATION NIPPLES - BEVELED END

Size	Black Steel		316 Stainless Steel	
	Part No.	Price	Part No.	Price
2"	STB25		RSTB25	
2-1/2"	STB30		RSTB30	
3"	STB35		300KCB	
4"	STB40		RSTB40	
5"	STB50		-	
6"	STB60		RSTB60	
8"	STB80		RSTB80	



HOSE BARB HOSE MENDER

Size	Plated Steel		Stainless Steel	
	Part No.	Price	Part No.	Price
3/8"	DMB		RDMB	
1/2"	SPHM050		RDM1	
5/8"	SPHM062		-	
3/4"	SPHM075		RDM6	
1"	SPHM100		RDM11	
1-1/4"	SPHM125		RDM16	
1-1/2"	SPHM150		RDM21	
2"	SPHM200		RDM26	
2-1/2"	SPHM250		-	
3"	SPHM300		RDM36	
4"	SPHM400		RDM46	
5"	DM51		-	
6"	SPHM600		-	
8"	SPHM800		-	



RING LOCK MALE X HOSE BARB

Part No.	Size	Price
IH240404	4"	
IH140406	6"	
IH140408	8"	
IH140410	10"	



RING LOCK FEMALE X HOSE BARB

Part No.	Size	Price
IH240004	4"	
IH140006	6"	
IH140008	8"	
IH140010	10"	



RING LOCK FEMALE X HOSE BARB WITH 2" NIPPLE

Part No.	Size	Price
RLFHB2-04	4"	
RLFHB2-06	6"	
RLFHB2-08	8"	
RLFHB2-10	10"	



TEE

Part No.	Size	Price
ART33	3"	
ART44	4"	
ART66	6"	
ART88	8"	



90° ELBOWS

Part No.	Size	Price
ARL3	3"	
ARL4	4"	
ARL6	6"	
ARL8	8"	



INTRO
1. ELECTRICAL
2. PUMP, ACC.
3. HOSE, PE PIPE & ACC.
4. IPS, PIP PIPE & ACC.
5. SURFACE
6. SPRINKLERS
7. TRAVELER & WHEEL MOVE
8. PIVOT
9. TURN
10. LOW VOLUME
11. FILTERS
12. INJECTION
13. HARDWARE
INDEX

CROSS

Part No.	Size	Price
ARX3	3"	
ARX4	4"	
ARX6	6"	
ARX8	8"	



MALE BAND & LATCH X HOSE BARB

Part No.	Size	Price
HAX44	4"	



WELD-ON HOSE BARB

Part No.	Size	Price
IRR-HB6	6"	
IRR-HB8	8"	



HOSE REPAIR SPLICE

Part No.	Size	Price
ARP2	2"	
ARP3	3"	
ARP4	4"	
ARP6	6"	
ARP8	8"	
ARP10	10"	

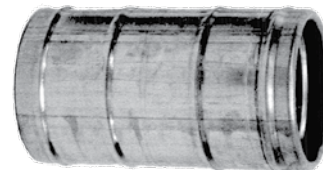

REDUCING HOSE REPAIR SPLICE

Part No.	Size	Price
ARS32	3" x 2"	
ARS43	4" x 3"	
ARS64	6" x 4"	
ARS86	8" x 6"	



GALVANIZED FEMALE BAND & LATCH X HOSE BARB

PIERCE

Part No.	Size	Price
P1788-61	2"	
P1788-62	3"	
P1788-63	4"	
P1788-64	5"	
P1788-65	6"	



TRAVIS

Part No.	Size	Price
BLSHF200	2"	
BLSHF300	3"	
BLSHF400	4"	
BLSHF500	5"	
BLSHF600	6"	
BLSHF800	8"	

GALVANIZED MALE BAND & LATCH X HOSE BARB

PIERCE

Part No.	Size	Price
P1791-01	2"	
P1791-02	3"	
P1791-04	4"	
P3150-04	4" w/ floating band	
P1791-06	5"	
P1791-07	6"	



TRAVIS

Part No.	Size	Price
BLSHM200	2"	
BLSHM300	3"	
BLSHM400	4"	
BLSHM500	5"	
BLSHM600	6"	
BLSHM800	8"	

GALVANIZED FEMALE RING LOCK X HOSE BARB

PIERCE

Part No.	Size	Price
P1842-62	4"	
P1842-64	6"	
P1842-65	8"	
P1842-66	10"	



TRAVIS

Part No.	Size	Price
SRLHF300	3"	
SRLHF400	4"	
SRLHF500	5"	
SRLHF600	6"	
SRLHF800	8"	
SRLHF1000	10"	

GALVANIZED FEMALE RING LOCK X HOSE BARB REDUCER



TRAVIS

Part No.	Size	Price
SRLHF604	6" x 4"	
SRLHF604.5	6" x 4-1/2"	
SRLHF806	8" x 6"	

GALVANIZED MALE RING LOCK X HOSE BARB

PIERCE

Part No.	Size	Price
P1843-02	4"	
P1843-04	6"	
P1843-05	8"	
P1843-06	10"	



TRAVIS

Part No.	Size	Price
SRLHM300	3"	
SRLHM400	4"	
SRLHM500	5"	
SRLHM600	6"	
SRLHM800	8"	
SRLHM1000	10"	

GALVANIZED MALE RING LOCK X HOSE BARB REDUCER



TRAVIS

Part No.	Size	Price
SRLHM603	6" x 3"	
SRLHM604	6" x 4"	
SRLHM604.5	6" x 4-1/2"	
SRLHM605	6" x 5"	
SRLHM806	8" x 6"	

INTRO | 1. ELECTRICAL | 2. PUMP ACC. | 3. HOSE, PE PIPE & ACC. | 4. IPS, PIP PIPE & ACC. | 5. SURFACE | 6. SPRINKLERS | 7. TRAVELER & WHEEL MOVE | 8. PIVOT | 9. TURF | 10. LOW VOLUME | 11. FILTERS | 12. INJECTION | 13. HARDWARE | INDEX

STEEL HOSE BARB FITTINGS

GALVANIZED FEMALE TWIST LOCK X HOSE BARB

PIERCE

Part No.	Size	Price
P0100-65	4" x 4"	
P0064-84	6" x 6"	



TRAVIS

Part No.	Size	Price
STLHF404	4"	
STLHF606	6"	

GALVANIZED FEMALE TWIST LOCK X HOSE BARB REDUCER

PIERCE

Part No.	Size	Price
P0066-16	6" x 4"	
P0116-51	6" x 4.5"	



TRAVIS

Part No.	Size	Price
STLHF604	6" x 4"	
STLHF604.5	6" x 4-1/2"	
STLHF605	6" x 5"	

GALVANIZED MALE TWIST LOCK X HOSE BARB

PIERCE

Part No.	Size	Price
P0100-64	4" x 4"	
P0064-83	6" x 6"	



TRAVIS

Part No.	Size	Price
STLHM606	6" x 6"	

GALVANIZED MALE TWIST LOCK X HOSE BARB REDUCER

PIERCE

Part No.	Size	Price
P0054-05	6" x 4.5"	



TRAVIS

Part No.	Size	Price
STLHM604	6" x 4"	
STLHM604.5	6" x 4-1/2"	
STLHM605	6" x 5"	

GALVANIZED HOSE BARB SPLICER

TRAVIS

Part No.	Size	Price
HRC200	2"	
HRC300	3"	
HRC400	4"	
HRC500	5"	
HRC600	6"	
HRC800	8"	



BLACK WELD-ON HOSE BARB

PIERCE

Part No.	Size	Price
P1790-02	3"	
P1790-04	4"	
P1790-05	4-1/2"	
P1790-06	5"	
P1790-07	6"	
P1790-08	8"	



TRAVIS

Part No.	Size	Price
HOSEBEAD-2	2"	
HOSEBEAD-21/2	2-1/2"	
HOSEBEAD-3	3"	
HOSEBEAD-4	4"	
HOSEBEAD-5	5"	
HOSEBEAD-6	6"	
HOSEBEAD-8	8"	
HOSEBEAD-10	10"	

ID CONTROLLED POLYETHYLENE PLASTIC PIPE

- The 80 PSI pipe is extruded from a wide spec utility grade resin and is not NSF approved.
- The 125 PSI, 160 PSI, 200 PSI & 250 PSI pipe is extruded from High Density PE4710 resin conforming to ASTM D 3350-05, manufactured in accordance with ASTM D2239, approved by the National Sanitation Foundation (NSF) for use in potable water systems and manufactured in accordance with AWWA standards.
- Pressure ratings are for water at 73.4° F. Be aware that as temperatures increase, pressure ratings decrease.
- Spec sheets available upon request.
- For use with insert pipe barbed fittings.
- Variety of coil lengths available.

UTILITY GRADE 80 PSI PRESSURE RATING - NOT NSF APPROVED

Part No.	Size	Nominal I.D.	Nominal O.D.	LBS./100'	Price / 100'
UGPE80050X100	1/2"	0.622"	.742"	6	 Please Call for Pricing
UGPE80075X100	3/4"	0.824"	.944"	8	
UGPE80100X100	1"	1.049"	1.189"	11	
UGPE80125X100	1-1/4"	1.380"	1.564"	19	
UGPE80150X100	1-1/2"	1.610"	1.824"	25	
UGPE80200X100	2"	2.067"	2.343"	42	

Due to volatile & continually changing market conditions which result in unstable Polyethylene pipe prices, we ask that you please call us to obtain current prices.

SIDR-15 125 PSI PRESSURE RATING

Part No.	Size	Nominal I.D.	Nominal O.D.	LBS./100'	Price / 100'
SIDR15075X100	3/4"	0.824"	.944"	8	 Please Call for Pricing
SIDR15100X100	1"	1.049"	1.189"	11	
SIDR15125X100	1-1/4"	1.380"	1.564"	19	
SIDR15150X100	1-1/2"	1.610"	1.824"	25	
SIDR15200X100	2"	2.067"	2.343"	42	

SIDR-11.5 160 PSI PRESSURE RATING

Part No.	Size	Nominal I.D.	Nominal O.D.	LBS./100'	Price / 100'
SIDR115050X100	1/2"	0.622"	.742"	6	 Please Call for Pricing
SIDR115075X100	3/4"	0.824"	.968"	9	
SIDR115100X100	1"	1.049"	1.231"	14	
SIDR115125X100	1-1/4"	1.380"	1.620"	25	
SIDR115150X100	1-1/2"	1.610"	1.890"	34	
SIDR115200X100	2"	2.067"	2.427"	55	

SIDR-9 200 PSI PRESSURE RATING

Part No.	Size	Nominal I.D.	Nominal O.D.	LBS./100'	Price / 100'
SIDR9075X100	3/4"	0.824"	1.008"	12	 Please Call for Pricing
SIDR9100X100	1"	1.049"	1.283"	19	
SIDR9125X100	1-1/4"	1.380"	1.686"	32	
SIDR9150X100	1-1/2"	1.610"	1.968"	44	
SIDR9200X100	2"	2.067"	2.527"	71	

SIDR-7 250 PSI PRESSURE RATING

Part No.	Size	Nominal I.D.	Nominal O.D.	LBS./100'	Price / 100'
SIDR7075X100	3/4"	0.824"	1.06"	15	 Please Call for Pricing
SIDR7100X100	1"	1.049"	1.349"	25	
SIDR7125X100	1-1/4"	1.380"	1.774"	42	
SIDR7150X100	1-1/2"	1.610"	2.07"	57	
SIDR7200X100	2"	2.067"	2.657"	94	

Note: 200 PSI copper tubing size (CTS) water service line tubing is also available & can be quoted on request.



INTRO | 1. ELECTRICAL | 2. PUMP Acc. | 3. HOSE: PE Pipe & Acc. | 4. IPS: PIP Pipe & Acc. | 5. SURFACE | 6. SPRINKLERS | 7. TRAVELER & WHEEL MOVE | 8. PIVOT | 9. TURF | 10. LOW VOLUME | 11. FILTERS | 12. INJECTION | 13. HARDWARE | INDEX

IPS OD CONTROLLED POLYETHYLENE PLASTIC PIPE

- Extruded from Extra High Molecular Weight (EHMW) High Density Polyethylene PE4710 resin conforming to ASTM D 3350-05, manufactured in accordance with ASTM D 3035-03a & F 714-05, approved by the National Sanitation Foundation (NSF) for use in potable water systems and manufactured in accordance with AWWA standards.
- Pressure ratings are for water at 73.4° F. Be aware that as temperatures increase, pressure ratings decrease.
- Spec sheets available upon request.
- For use with butt fusion, socket fusion & electrofusion fittings.
- Variety of coil lengths available.

DR-17 125 PSI PRESSURE RATING

Part No.	Size	Nominal I.D.	Nominal O.D.	LBS./100'	Price / 100'
DR17075X100	3/4"	0.926"	1.050"	8	 Please Call for Pricing
DR17100X100	1"	1.161"	1.315"	13	
DR17125X100	1-1/4"	1.464"	1.660"	20	
DR17150X100	1-1/2"	1.676"	1.900"	27	
DR17200X100	2"	2.095"	2.375"	43	
DR17300X100	3"	3.088"	3.500"	93	
DR17400X100	4"	3.970"	4.500"	154	

Due to volatile & continually changing market conditions which result in unstable Polyethylene pipe prices, we ask that you please call us to obtain current prices.

DR-13.5 160 PSI PRESSURE RATING

Part No.	Size	Nominal I.D.	Nominal O.D.	LBS./100'	Price / 100'
DR135075X100	3/4"	0.894"	1.050"	10	 Please Call for Pricing
DR135100X100	1"	1.121"	1.315"	16	
DR135125X100	1-1/4"	1.414"	1.660"	26	
DR135150X100	1-1/2"	1.618"	1.900"	34	
DR135200X100	2"	2.023"	2.375"	53	
DR135300X100	3"	2.982"	3.500"	115	
DR135400X100	4"	3.834"	4.500"	191	

DR-11 200 PSI PRESSURE RATING

Part No.	Size	Nominal I.D.	Nominal O.D.	LBS./100'	Price / 100'
DR11075X100	3/4"	0.860"	1.050"	13	 Please Call for Pricing
DR11100X100	1"	1.075"	1.315"	20	
DR11125X100	1-1/4"	1.358"	1.660"	31	
DR11150X100	1-1/2"	1.554"	1.900"	41	
DR11200X100	2"	1.943"	2.375"	64	
DR11300X100	3"	2.864"	3.500"	139	
DR11400X100	4"	3.682"	4.500"	230	

DR-9 250 PSI PRESSURE RATING

Part No.	Size	Nominal I.D.	Nominal O.D.	LBS./100'	Price / 100'
DR9075X100	3/4"	0.816"	1.050"	15	 Please Call for Pricing
DR9100X100	1"	1.023"	1.315"	23	
DR9125X100	1-1/4"	1.292"	1.660"	37	
DR9150X100	1-1/2"	1.478"	1.900"	49	
DR9200X100	2"	1.847"	2.375"	77	
DR9300X100	3"	2.722"	3.500"	166	
DR9400X100	4"	3.500"	4.500"	275	

DR-7 333 PSI PRESSURE RATING

Part No.	Size	Nominal I.D.	Nominal O.D.	LBS./100'	Price / 100'
DR7075X100	3/4"	0.750"	1.050"	18	 Please Call for Pricing
DR7100X100	1"	0.939"	1.315"	29	
DR7125X100	1-1/4"	1.186"	1.660"	46	
DR7150X100	1-1/2"	1.358"	1.900"	60	
DR7200X100	2"	1.697"	2.375"	95	
DR7300X100	3"	2.50"	3.500"	206	
DR7400X100	4"	3.214"	4.500"	340	

DR-6 400 PSI PRESSURE RATING

Part No.	Size	Nominal I.D.	Nominal O.D.	LBS./100'	Price / 100'
DR6100X100	1"	0.877"	1.315"	32	 Please Call for Pricing
DR6125X100	1-1/4"	1.106"	1.660"	50	
DR6150X100	1-1/2"	1.266"	1.900"	66	
DR6200X100	2"	1.583"	2.375"	103	

Note: Larger diameter pipe available upon request.



IPS HDPE MOLDED & FABRICATED FITTINGS

The following fittings are for use with IPS High Density Polyethylene Pipe and are to be installed by the heat fusion method, either Butt Fusion, Socket Fusion or Electrofusion. The principle of heat fusion is to heat two surfaces to a designated temperature, and then to fuse them together by applying pressure. When the polyethylene pipe is heated, the molecular structure is transformed from a crystalline state into an amorphous condition. When fusion pressure is applied, the molecules from each pipe end mix. As the joint cools, the molecules return to their crystalline form, the original surfaces are gone and the two pipe ends become fused together as one homogeneous piece. The welds are as strong or stronger than the pipe itself and leak-free when proper fusion procedures are followed. Fusion machines are required in the conjoining of these fittings to the pipe. Please call us if you need assistance or would like help in selecting the right fittings and fusion equipment for your application.

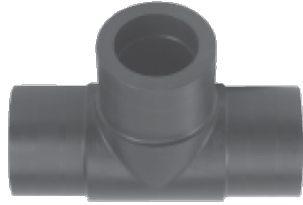

BUTT FUSION TEE

Part No.	Size	DR	PSI	Price
10003969	3/4"	11	160	
10003838	1"	11	160	
10003815	1-1/4"	11	160	
10003931	1-1/2"	9	200	
10004230		11	160	
10011761	2"	7	265	
10004250		9	200	
10002956		11	160	
10011762	3"	7	265	
10004253		9	200	
10007746		11	160	
10011763	4"	7	265	
10002073		9	200	
10003478		11	160	



BUTT FUSION 90° ELL

Part No.	Size	DR	PSI	Price
10004109	3/4"	11	160	
10004111	1"	11	160	
10002945	1-1/4"	11	160	
10004114	1-1/2"	9	200	
10004113		11	160	
10011756	2"	7	265	
10004131		9	200	
10002946		11	160	
10011757	3"	7	265	
10004133		9	200	
10007745		11	160	
10011758	4"	7	265	
10004137		9	200	
10001630		11	160	



BUTT FUSION 45° ELL

Part No.	Size	DR	PSI	Price
10011751	2"	7	265	
10009503		11	160	
10011752	3"	7	265	
10004087		9	200	
10002941		11	160	
10011753	4"	7	265	
10004094		9	200	
10002942		11	160	



BUTT FUSION CONCENTRIC REDUCER

Part No.	Size	DR	PSI	Price
10004192	1" x 3/4"	9	200	
10004197	1-1/4" x 1"	11	160	
10003947	1-1/2" x 3/4"	9	200	
10004199	1-1/2" x 1"	9	200	
10004198		11	160	
10007485	2" x 1"	11	160	
10007479	2" x 1-1/4"	11	160	
10003814	2" x 1-1/2"	11	160	
10011766	3" x 2"	7	265	
10004209		9	200	
10007480		11	160	
10011767	4" x 2"	7	265	
10004215		9	200	
10007481		11	160	
10011768	4" x 3"	7	265	
10004216		9	200	
10007482		11	160	



BUTT FUSION CAP

Part No.	Size	DR	PSI	Price
10003713	3/4"	11	160	
10003837	1"	11	160	
10001876	1-1/4"	11	160	
10004159	1-1/2"	11	160	
10011771	2"	7	265	
10004165		11	160	
10011772	3"	7	265	
10002937		11	160	
10011773	4"	7	265	
10002938		11	160	

Note: Many different types of molded and fabricated fittings are available for different fusion methods. A sampling of these fittings are found on this and the following pages. If you don't see exactly what you're needing and would like our assistance in helping you locate what you need, please give us a call.

IPS HDPE MOLDED & FABRICATED FITTINGS

Our HDPE (Polyethylene) Electrofusion Fittings are manufactured by Elofit.

AWWA, ASTM, NSF Certified for Water and Gas Applications

Made of PE100 (Compatible with PE 2406, PE 3408, PE4710, PE100, and PE 3608 Pipe and Fittings)



ELECTROFUSION COUPLINGS

Part No.	Size	Min. SDR	PSI	Price
12EIME34	3/4"	11	200	
12EIME01	1"	11	200	
12EIME114	1-1/4"	11	200	
12EIME02	2"	17	200	
12EIME03	3"	17	200	
12EIME04	4"	17	200	



ELECTROFUSION REDUCER

Part No.	Size	Min. SDR	PSI	Price
12EIRDE134	1" x 3/4"	11	200	
12EIRDE2114	2" x 1-1/4"	17	200	
12EIRDE0302	3" x 2"	11	200	
12EIRDE0402	4" x 2"	11	200	
12EIRDE0403	4" x 3"	11	200	



ELECTROFUSION TEE

Part No.	Size	Min. SDR	PSI	Price
12EITCE02	2"	11	200	
12EITCE03	3"	11	200	
12EITCE04	4"	11	200	

Note: For sizes not available use electrofusion coupling with butt fusion fitting



ELECTROFUSION ELBOW

Part No.	Size	Min. SDR	PSI	Price
12EIGEM02	2"	11	200	
12EIGEM03	3"	11	200	
12EIGEM04	4"	11	200	

Note: For sizes not available use electrofusion coupling with butt fusion fitting

Note: Additional electrofusion fittings available by request



FLANGE ADAPTER

Part No.	Size	DR	PSI	Price
10004396	2"	7	265	
10004397		9	200	
10007486		11	160	
10004446	3"	7	265	
10004447		9	200	
10007487		11	160	
6912368	4"	7	265	
10003642		9	200	
6912104		11	160	



BACK UP RING (USE WITH FLANGE ADAPTER)

Part No.	Size	Material	Price
10007832	2"	Ductile Iron-Red Oxide Primer	
10007833	3"	Ductile Iron-Red Oxide Primer	
10007834	4"	Ductile Iron-Red Oxide Primer	

NOTE: 1/2" Steel plate flanges can be used in place of back up rings



**BUTT FUSION
STEEL MALE THREADED
TRANSITION FITTINGS**

Part No.	Size	DR	PSI	Price
650757511100	3/4"	11	160	
650010111800	1"	11	160	
10003221	1-1/4"	7	265	
650121211810	1-1/4"	11	160	
10003622	1-1/2"	7	265	
6501155	1-1/2"	11	160	
650020211820	2"	7	265	
650020211800	2"	11	160	
650030311830	3"	7	265	
650030311810	3"	11	160	
650040411830	4"	7	265	
650040411810	4"	11	160	



**BUTT FUSION
STAINLESS STEEL MALE THREADED
TRANSITION FITTING**

Part No.	Size	DR	PSI	Price
6501229	3/4"	11	160	
6501231	1"	11	160	
6501232	1-1/4"	11	160	
6501230	1-1/2"	11	160	
6501233	2"	11	160	
10007495	3"	11	160	
10009018	4"	11	160	

HAMMER UNION

Part No.	Size	Price
U020100	1" Figure 200 SE	
U021200	1-1/4" Figure 200 SE	
U010200	2" Figure 100 SE	
U010300	3" Figure 100 SE	
U010400	4" Figure 100 SE	



TRANSITION SERVICE RISER

Part No.	Size	Description	Price
600010136000	1"	1" MPT x 1" Yellow DR 11 Transition Riser 36V x 24H	
6000119	1"	1" MPT x 1" Black DR 11 Transition Riser 30V x 30H	
600121236000	1-1/4"	1-1/4" MPT x 1-1/4" Yellow DR 11 Transition Riser 36V x 24H	
600151536000	1-1/2"	1-1/2" MPT x 1-1/2" Yellow DR 11 Transition Riser 36V x 24H	
10013476	2"	2" MPT x 2" Black DR 11 Transition Riser 36V x 24H	

Note: Additional gas risers available by request



INTRO
1. ELECTRICAL
2. PUMP Acc.
3. HOSE, PE Pipe & Acc.
4. IPS, PIP Pipe & Acc.
5. SURFACE
6. SPRINKLERS
7. TRAVELER & WHEEL MOVE
8. PIVOT
9. TURF
10. LOW VOLUME
11. FILTERS
12. INJECTION
13. HARDWARE
INDEX

BS-4 BUTT FUSION KIT

Part No.	Description	Weight	Price
10004000	BS-4 Butt Fusion Kit	63 lbs.	

Note: Liners for sizes not included sold separately.

Kit includes:

- BS-4 Machine
- 1-1/4", 2", and 3" BS-4 liners
- Electric trimmer
- Model 4 heater and heater faces
- Heater muff
- Job cart



3-SF SOCKET FUSION KIT

Part No.	Description	Weight	Price
10006132	3-SF Socket Fusion Kit	22.2 lbs.	

Kit Includes:

- Model 3 SF narrow profile-dual socket heater
- 3/4" Model 3 SF plug & socket
- 1-1/4" Model 3 SF plug & socket
- Heater muff
- Model 3 SF heater dual angle holder chamfer/depth tools
- 3/4" & 1-1/4" Cold rings
- Ratchet-style pipe cutter
- Storage box



SOCKET FUSION PLUG & SOCKETS

Standard	3 SF	Size	Description	Price
555SP2750000	10006170	3/4"	IPS Plug & Socket	
555SP2010000	10006171	1"	IPS Plug & Socket	
555SP2120000	10006172	1-1/4"	IPS Plug & Socket	
555SP2150000	10006665	1-1/2"	IPS Plug & Socket	
555SP2020000	10006666	2"	IPS Plug & Socket	
555SP2030000	-	3"	IPS Plug & Socket	
555SP2040000	-	4"	IPS Plug & Socket	

Standard used with BS-4 Butt Fusion heater.

3 SF used with 3-SF Socket Fusion heater.

ELOFIT ELECTROFUSION WELDING MACHINE W/BARCODE AND BLUETOOTH 110V

Part No.	Description	Price
12E9001/110	Machine Welding Capacity - 1/2" CTS to 32" IPS (Up to 42 Volt Cycles)	

Kit Includes:

- Standard hard plastic transport case
- User manual quick guide and data download software CD
- Plastic HDPE transport / shipping box
- Handheld barcode scanner
- Connection cables with 4mm connector pins and adapters for 4.7mm pins.
- Manual hand-held electrofusion pipe scraper
- 110v 30amp Twist lock x 15amp standard wall plug adapter



ADJUSTABLE ELECTROFUSION PIPE CLAMP SET (BELT STYLE 2" - 8" CAPACITY)

Part No.	Description	Price
00ALL225/4	Machine Welding Capacity - 1/2" CTS to 32" IPS (Up to 42 Volt Cycles)	

NOTE: If you order two of these clamp sets they can also be configured to clamp tees and lateral wyes.

Set Includes:

- 2" - 8" IPS or DIPS Capacity
- 4 Strap Style Alignment Clamps, 2 Main Clamp Bars and 1 Alignment Plate.
- 45 degree and 90 degree bar brackets for welding elbows



Individual parts for all kits sold separately.

PVC INSERT FITTINGS

For use with polyethylene pipe, rubber discharge hose or PVC layflat discharge hose. Additional fittings available upon request. Please call for special fitting requirements.

FITTING DIMENSIONS					
Nominal Size	Average Barb	Nominal Size	Average Barb	Nominal Size	Average Barb
1/2"	.65"	2" TS	2.01"	6"	6.09"
3/4"	.85"	2-1/2"	2.50"	6" TS	6.02"
1"	1.08"	3"	3.11"	8"	8.15"
1-1/4"	1.41"	3" TS	3.01"	8" TS	8.02"
1-1/2"	1.65"	4"	4.07"	10"	10.15"
2"	2.11"	4" TS	4.01"	10" TS	10.02"

Note: TS is True Size for Layflat

TEE (INS X INS X INS)



Part No.	Size-In.	Box Qty	Price
1401-005	1/2	50	
1401-007	3/4	50	
1401-010	1	25	
1401-012	1-1/4	10	
1401-015	1-1/2	10	
1401-020	2	10	
T-02.5	2-1/2	NA	
T-03	3	15	
T-04	4	8	
T-06	6	3	
T-08	8	NA	

TEE (INS X INS X FIPT)



Part No.	Size-In.	Box Qty	Price
1402-005	1/2	50	
1402-007	3/4	50	
1402-010	1	25	
1402-012	1-1/4	10	
1402-015	1-1/2	10	
1402-020	2	10	

90° ELL (INS X INS)



Part No.	Size-In.	Box Qty	Price
1406-005	1/2	50	
1406-007	3/4	50	
1406-010	1	25	
1406-012	1-1/4	10	
1406-015	1-1/2	10	
1406-020	2	10	
1406-025	2-1/2	10	
L-03	3	20	
L-04	4	12	
L-06	6	4	
L-08	8	NA	

REDUCING TEE (INS X INS FIPT)



Part No.	Size-In.	Qty	Price
1402-094	3/4 x 1/2 x 1/2	25	
1402-101	3/4 x 3/4 x 1/2	25	
1402-124	1 x 3/4 x 1/2	25	
1402-125	1 x 3/4 x 3/4	25	
1402-130	1 x 1 x 1/2	25	
1402-131	1 x 1 x 3/4	25	
1402-156	1-1/4 x 1 x 1/2	25	
1402-157	1-1/4 x 1 x 3/4	25	
1402-166	1-1/4 x 1-1/4 x 1/2	25	
1402-167	1-1/4 x 1-1/4 x 3/4	25	
1402-168	1-1/4 x 1-1/4 x 1	25	
1402-199	1-1/2 x 1-1/4 x 1/2	25	
1402-201	1-1/2 x 1-1/4 x 3/4	10	
1402-202	1-1/2 x 1-1/4 x 1	10	
1402-209	1-1/2 x 1-1/2 x 1/2	10	
1402-210	1-1/2 x 1-1/2 x 3/4	10	
1402-211	1-1/2 x 1-1/2 x 1	10	
1402-212	1-1/2 x 1-1/2 x 1-1/4	10	
1402-247	2 x 2 x 1/2	10	
1402-248	2 x 2 x 3/4	10	
1402-249	2 x 2 x 1	10	
1402-251	2 x 2 x 1-1/2	10	

REDUCING TEE (INS X INS X INS)



Part No.	Size-In.	Qty	Price
1401-074	1/2 x 1/2 x 3/4	25	
1401-094	3/4 x 1/2 x 1/2	25	
1401-101	3/4 x 3/4 x 1/2	25	
1401-102	3/4 x 3/4 x 1	25	
1401-124	1 x 3/4 x 1/2	25	
1401-125	1 x 3/4 x 3/4	25	
1401-130	1 x 1 x 1/2	25	
1401-131	1 x 1 x 3/4	25	
1401-132	1 x 1 x 1-1/4	25	
1401-156	1-1/4 x 1 x 1/2	25	
1401-157	1-1/4 x 1 x 3/4	25	
1401-158	1-1/4 x 1 x 1	25	
1401-166	1-1/4 x 1-1/4 x 1/2	25	
1401-167	1-1/4 x 1-1/4 x 3/4	25	
1401-168	1-1/4 x 1-1/4 x 1	25	
1401-201	1-1/2 x 1-1/4 x 3/4	10	
1401-202	1-1/2 x 1-1/4 x 1	10	
1401-203	1-1/2 x 1-1/4 x 1-1/4	10	
1401-209	1-1/2 x 1-1/2 x 1/2	10	
1401-210	1-1/2 x 1-1/2 x 3/4	10	
1401-211	1-1/2 x 1-1/2 x 1	10	
1401-212	1-1/2 x 1-1/2 x 1-1/4	10	
1401-241	2 x 1-1/2 x 1-1/2	10	
1401-247	2 x 2 x 1/2	10	
1401-248	2 x 2 x 3/4	10	
1401-249	2 x 2 x 1	10	
1401-250	2 x 2 x 1-1/4	10	
1401-251	2 x 2 x 1-1/2	10	
1401-335	3 x 3 x 1	5	
1401-338	3 x 3 x 2	5	

TEE (INS X INS X MIPT)



Part No.	Size-In.	Box Qty	Price
1403-005	1/2	50	
1403-007	3/4	50	
1403-010	1	25	
1403-012	1-1/4	10	
1403-015	1-1/2	10	
1403-020	2	10	

REDUCING TEE

1403-130	1 x 1 x 1/2	25	
1403-131	1 x 1 x 3/4	25	

TEE (INS X INS X SOCKET)



Part No.	Size-In.	Box Qty	Price
1404-010	1	25	
1404-102	3/4 x 3/4 x 1	100	

90° REDUCING ELL (INS X INS)



Part No.	Size-In.	Box Qty	Price
1406-101	3/4 x 1/2	25	
1406-131	1 x 3/4	25	
1406-168	1-1/4 x 1	25	
1406-212	1-1/2 x 1-1/4	10	
1406-251	2 x 1-1/2	10	

90° ELL (INS X FIPT)



Part No.	Size-In.	Box Qty	Price
1407-005	1/2	50	
1407-007	3/4	50	
1407-010	1	25	
1407-012	1-1/4	10	
1407-015	1-1/2	10	
1407-020	2	10	

90° REDUCING ELL (INS X FIPT)



Part No.	Size-In.	Box Qty	Price
1407-074	1/2 x 3/4	50	
1407-101	3/4 x 1/2	50	
1407-130	1 x 1/2	25	
1407-131	1 x 3/4	25	
1407-166	1-1/4 x 1/2	25	
1407-167	1-1/4 x 3/4	25	
1407-168	1-1/4 x 1	25	
1407-211	1-1/2 x 1	10	
1407-212	1-1/2 x 1-1/4	10	
1407-251	2 x 1-1/2	10	

INTRO
1. ELECTRICAL
2. PUMP ACC.
3. HOSE, PE PIPE & ACC.
4. FPS, PIP PIPE & ACC.
5. SURFACE
6. SPRINKLERS
7. TRAVELER & WHEEL MOVE
8. PIVOT
9. TURF
10. LOW VOLUME
11. FILTERS
12. INJECTION
13. HARDWARE
INDEX

PVC INSERT FITTINGS

90° ELL (INS X MIPT)



Part No.	Size-In.	Box Qty	Price
1413-005	1/2	50	
1413-007	3/4	50	
1413-010	1	25	
1413-012	1-1/4	10	
1413-015	1-1/2	10	
1413-020	2	10	

90° REDUCING ELL

1413-101	3/4 x 1/2	50	
1413-130	1 x 1/2	50	
1413-131	1 x 3/4	50	

SIDE OUTLET ELL (INS X INS X FIPT)



Part No.	Size-In.	Qty	Price
1414-101	3/4 x 3/4 x 1/2	50	
1414-130	1 x 1 x 1/2	25	
1414-131	1 x 1 x 3/4	50	

SIDE OUTLET TEE (INS X INS X INS X FIPT)



Part No.	Size-In.	Qty	Price
1416-007	3/4 x 3/4 x 3/4 x 3/4	50	
1416-101	3/4 x 3/4 x 3/4 x 1/2	50	
1416-130	1 x 1 x 1 x 1/2	50	
1416-131	1 x 1 x 1 x 3/4	50	

CROSS (INS X INS X INS X INS)



Part No.	Size-In.	Box Qty	Price
1420-007	3/4	25	
1420-010	1	25	

COUPLING (INS X INS)



Part No.	Size-In.	Box Qty	Price
1429-005	1/2	50	
1429-007	3/4	50	
1429-010	1	50	
1429-012	1-1/4	25	
1429-015	1-1/2	25	
1429-020	2	25	
C-02TS	2	50	
1429-025	2-1/2	10	
1429-030	3	10	
C-03TS	3	60	
1429-040	4	10	
C-04TS	4	30	
C-05TS	5	NA	
1429-060	6	8	
C-06	6	13	
C-06TS	6	13	
C-08	8	4/6/12	
C-08TS	8	4/6/12	
C-10	10	NA	
C-10TS	10	NA	

REDUCING COUPLING (INS X INS)



Part No.	Size-In.	Box Qty	Price
1429-101	3/4 x 1/2	50	
1429-130	1 x 1/2	50	
1429-131	1 x 3/4	50	
1429-167	1-1/4 x 3/4	25	
1429-168	1-1/4 x 1	25	
1429-210	1-1/2 x 3/4	25	
1429-211	1-1/2 x 1	25	
1429-212	1-1/2 x 1-1/4	25	
1429-249	2 x 1	10	
1429-250	2 x 1-1/4	10	
1429-251	2 x 1-1/2	10	
R-25X2	2-1/2 x 2	NA	
1429-338	3 x 2	12	
R-3X25	3 x 2-1/2	NA	
R-4X2	4 x 2	NA	
R-4X3	4 x 3	30	
R-6X4	6 x 4	6	
R-6X5	6 x 5	NA	
R-8X4	8 x 4	NA	
R-8X6	8 x 6	NA	

FEMALE ADAPTER (FIPT X INS)



Part No.	Size-In.	Box Qty	Price
1435-005	1/2	50	
1435-007	3/4	50	
1435-010	1	50	
1435-012	1-1/4	25	
1435-015	1-1/2	25	
1435-020	2	10	
FA-025	2-1/2	NA	
FA-03	3	NA	
FA-04	4	NA	
FA-06	6	NA	
FA-08	8	NA	

MALE ADAPTER (MIPT X INS)



Part No.	Size-In.	Box Qty	Price
1436-005	1/2	50	
1436-007	3/4	50	
1436-010	1	50	
1436-012	1-1/4	20	
1436-015	1-1/2	25	
1436-020	2	10	
1436-025	2-1/2	10	
1436-030	3	10	
1436-040	4	10	
MA-06	6	12	
MA-08	8	4/6/12	
MA-10	10	NA	

REDUCING MALE ADAPTER

1436-074	1/2 x 3/4	50	
1436-075	1/2 x 1	50	
1436-101	3/4 x 1/2	50	
1436-102	3/4 x 1	50	
1436-131	1 x 3/4	50	
1436-132	1 x 1-1/4	25	
1436-133	1 x 1-1/2	25	
1436-167	1-1/4 x 3/4	25	
1436-168	1-1/4 x 1	25	
1436-169	1-1/4 x 1-1/2	10	
1436-211	1-1/2 x 1	25	
1436-212	1-1/2 x 1-1/4	25	
1436-213	1-1/2 x 2	10	
1436-251	2 x 1-1/2	10	

HOSE ADAPTER (MHT X INS)



Part No.	Size-In.	Box Qty	Price
1436-007MHT	3/4	50	
REDUCING HOSE ADAPTER			
1436-101MHT	3/4 x 1/2	50	
1436-102MHT	3/4 x 1	50	

ADAPTER (INS X SPIG)



Part No.	Size-In.	Box Qty	Price
460-005	1/2	50	
460-007	3/4	50	
460-010	1	50	
460-012	1-1/4	20	
460-015	1-1/2	25	
460-020	2	10	
ISP-2TS	2	100	
ISP-2.5	2-1/2	NA	
460-030	3	25	
ISP-3TS	3	50	
460-040	4	10	
ISP-4TS	4	30	
ISP-6	6	12	
ISP-6TS	6	12	
ISP-8	8	4/6/12	
ISP-8TS	8	4/6/12	
ISP-10	10	NA	

ADAPTER (INS X SLIP)



Part No.	Size-In.	Box Qty	Price
474-005	1/2	50	
474-007	3/4	50	
474-010	1	50	
474-012	1-1/4	25	
474-015	1-1/2	25	
474-020	2	25	
474-030	3	15	
IXS-3TS	3	45	
474-040	4	15	
IXS-4TS	4	30	
IXS-6	6	16	
IXS-6TS	6	16	
IXS-8	8	NA	
IXS-8TS	8	NA	
IXS-10	10	NA	

PLUG (INS)



Part No.	Size-In.	Box Qty	Price
1449-005	1/2	100	
1449-007	3/4	100	
1449-010	1	50	
1449-012	1-1/4	25	
1449-015	1-1/2	25	
1449-020	2	10	
PL025	2-1/2	NA	
PL03	3	50	
PL04	4	30	
PL06	6	12	
PL08	8	NA	

FLOPLAST POLYPROPYLENE COMPRESSION FITTINGS

Rating is 232 PSI from 68°F to 176°F

FloPlast Compression Fittings are for use with IPS HDPE High Density Polyethylene Pipe and PVC Pipe with our "exclusive" PVC Conversion Ring. FloPlast Fittings are superior in price, diversity, quality and meeting industry standards, in comparison to similar competitive products. Points to consider are:

- Products meet AWWA C-901 and C906-90
- Products are NSF approved
- Products meet ISO standards for MRS value, Temperature and PSI Standards, Leaktightness Standards
- Products have a 50 year life expectancy
- Rating is 232PSI for all fittings offered
- In accordance with ISO 3501, test results show 2200lbs of pullout resistance of the grip rings, translating into more reliable and longer lasting connections for all applications.
- Maximum temperature is 176°F at 232PSI
- Fittings install in minutes resulting in labor and equipment cost savings
- Fittings provide simple to understand installation procedures
- Fittings can be used in new installation or in most repair/maintenance situations
- Fittings come in IPS, CTS and Universal sizes and can be used to connect most all types of pipe
- Application fields are Oil & Gas, drinkable water, waste water, salt water and commercial irrigation, industrial applications including acid bases, swimming pools, ship installations, and fiber duct pipe, and most applications where HDPE Pipe is used

In your search for a superior compression fitting that meets all your needs, FloPlast Fittings are a solid choice considering price, quality, are cost effective, extremely convenient to install, are re-usable, can withstand more pressure than the pipe itself and the pipe will break before the fitting will.

Watch for (*) Additional fittings available upon request. Please call for special fitting requirements.
Need CTS Size compression fittings? - Available from FloPlast. Please call for pricing and availability.



COUPLING

Part No.	Size	Box Qty.	Price
701020IPS	1/2"	50	
701025IPS	3/4"	40	
701032IPS	1"	25	
701040IPS	1-1/4"	13	
701050IPS	1 1/2"	15	
701063IPS	2"	17	
701090IPS	3"	8	
701110IPS	4"	4	



MALE ADAPTER *

Part No.	Pipe Size IPS	Thread Size NPT	Box Qty.	Price
704020IPS	1/2"	1/2"	90	
704025IPS	3/4"	3/4"	60	
704032IPS	1"	1"	45	
704040IPS	1-1/4"	1-1/4"	23	
704050IPS	1-1/2"	1-1/2"	30	
704063IPS	2"	2"	34	
704090IPS	3"	3"	12	
704110IPS	4"	4"	6	

SLIP COUPLING +

Part No.	Size	Box Qty.	Price
725063IPS	2"	17	
725090IPS	3"	8	
725110IPS	4"	4	

+ Slip Couplings are the same as couplings BUT DO NOT HAVE A MIDDLE STOP. Just slip onto the pipe - slide over the splice and tighten. Done in minutes!



FEMALE ADAPTER *

Part No.	Pipe Size IPS	Thread Size NPT	Box Qty.	Price
703020IPS	1/2"	1/2"	90	
703025IPS	3/4"	3/4"	60	
703032IPS	1"	1"	35	
703040IPS	1-1/4"	1-1/4"	22	
703050IPS	1-1/2"	1-1/2"	27	
703063IPS	2"	2"	30	
703090IPS	3"	3"	12	
703110IPS	4"	4"	6	

REDUCING COUPLING *

Part No.	Size	Box Qty.	Price
702032IPS	1" - 3/4"	30	
702040IPS	1-1/4" - 1"	18	
702050IPS	1-1/2" - 1-1/4"	20	
702062IPS	2" - 1-1/4"	20	
702063IPS	2" - 1-1/2"	20	

INTRO
 1. ELECTRICAL
 2. PUMP ACC.
 3. HOSE, PE PIPE & ACC.
 4. IPS, PIP PIPE & ACC.
 5. SURFACE
 6. SPRINKLERS
 7. TRAVELER & WHEEL MOVE
 8. PIVOT
 9. TURF
 10. LOW VOLUME
 11. FILTERS
 12. INJECTION
 13. HARDWARE
 INDEX

IPS HDPE COMPRESSION FITTINGS

FLOPLAST POLYPROPYLENE COMPRESSION FITTINGS

Rating is 232 PSI from 68°F to 176°F

Watch for (*) Additional fittings available upon request. Please call for special fitting requirements.



90° ELBOW

Part No.	Size	Box Qty.	Price
706020IPS	1/2"	45	
706025IPS	3/4"	35	
706032IPS	1"	20	
706040IPS	1-1/4"	12	
706050IPS	1-1/2"	12	
706063IPS	2"	14	
706090IPS	3"	6	
706110IPS	4"	3	



TEE

Part No.	Size	Box Qty.	Price
709020IPS	1/2"	30	
709025IPS	3/4"	20	
709032IPS	1"	12	
709040IPS	1-1/4"	6	
709050IPS	1-1/2"	8	
709063IPS	2"	10	
709090IPS	3"	4	
709110IPS	4"	1	



90° ELBOW WITH THREADED MALE OFFTAKE*

Part No.	Pipe Size IPS	Thread Size NPT	Box Qty.	Price
707020IPS	1/2"	1/2"	70	
707025IPS	3/4"	3/4"	40	
707032IPS	1"	1"	30	
707040IPS	1-1/4"	1-1/4"	15	
707050IPS	1-1/2"	1-1/2"	18	
707063IPS	2"	2"	20	



TEE WITH THREADED MALE OFFTAKE

Part No.	Pipe Size IPS	Thread Size NPT	Box Qty.	Price
711020IPS	1/2"	1/2"	40	
711025IPS	3/4"	3/4"	30	
711032IPS	1"	1"	15	
711040IPS	1-1/4"	1-1/4"	9	
711050IPS	1-1/2"	1-1/2"	10	
711063IPS	2"	2"	12	



90° ELBOW WITH THREADED FEMALE OFFTAKE*

Part No.	Pipe Size IPS	Thread Size NPT	Box Qty.	Price
708020IPS	1/2"	1/2"	70	
708025IPS	3/4"	3/4"	40	
708032IPS	1"	1"	30	
708040IPS	1-1/4"	1-1/4"	15	
708050IPS	1-1/2"	1-1/2"	18	
708063IPS	2"	2"	20	
708090IPS	3"	3"	8	
708110IPS	4"	4"	4	



TEE WITH THREADED FEMALE OFFTAKE*

Part No.	Pipe Size IPS	Thread Size NPT	Box Qty.	Price
710020IPS	1/2"	1/2"	40	
710024IPS	3/4"	1/2"	25	
710025IPS	3/4"	3/4"	25	
710031IPS	1"	3/4"	15	
710032IPS	1"	1"	15	
710040IPS	1-1/4"	1-1/4"	9	
710050IPS	1-1/2"	1-1/2"	10	
710063IPS	2"	2"	11	
710090IPS	3"	3"	4	
710110IPS	4"	4"	2	

FLOPLAST POLYPROPYLENE COMPRESSION FITTINGS

Rating is 232 PSI from 68°F to 176°F

PE-PE VALVE

Part No.	Size	Box Qty.	Price
141020CI	1/2"	75	
141025CI	3/4"	28	
141032CI	1"	28	
141040CI	1-1/4"	12	
141050CI	1-1/2"	12	
141063CI	2"	5	



STOP THE FLOW ANY TIME!

- FloPlast IPS Valves
- Applications for 1/2" to 2"
- Fittings rated at 232 PSI
- A longitudinal pullout resistance of 2200 lbs
- Replacable parts for easy serviceability
- Reusable; can be used in new installation or in most repair/maintenance situations
- More configurations available upon request

PVC GRIP RINGS

Part No.	Size	Box Qty.	Price
000120PVI	1/2"	75	
000125PVI	3/4"	75	
000132PVI	1"	75	
000140PVI	1-1/4"	75	
000150PVI	1-1/2"	75	
000163PVI	2"	75	
000190PVI	3"	70	
000110PVI	4"	75	



NEED FITTINGS FOR PVC?
THIS IS YOUR SOLUTION!!!

- Convert any FloPlast IPS Fitting for use with PVC
- Use on one end or both ends
- Applications for 1/2" to 4"
- Fittings rated at 232 PSI
- A longitudinal pullout resistance of 2200 lbs
- Reusable; can be used in new installation or in most repair/maintenance situations

GALVANIZED GRIP RING

Convert IPS Fittings for use with Galvanized, Stainless Steel, Iron or other IPS Pipe.

Part No.	Size	Box Qty.	Price
000163GLV	2"	75	



FLOPLAST POLYPROPYLENE UNIVERSAL COMPRESSION FITTINGS

Rating is 232 PSI from 68°F to 176°F

FloPlast Universal Compression Fittings are the answer to multiple pipe needs problems. They are for use with HDPE High Density Polyethylene Pipe in IPS and CTS sizes, PVC Pipe, Copper, and Galvanized Steel.

- Universal Fittings meet all the same standards as our IPS products.
- Fittings install in minutes resulting in labor and equipment cost savings.
- Fittings provide simple to understand installation procedures.
- Fittings can be used in new installation or in most repair/maintenance situations.

Use these on either end for conversion from one type of pipe to another and for quick repairs to the same type of pipe.



- PVC
- HDPE - CTS
- HDPE - IPS
- Galvanized Steel
- Lead
- Copper



UNIVERSAL REPAIRING COUPLING *

Part No.	Universal	Universal	Box Qty.	Price
730101	3/8" - 1/2"	3/8" - 1/2"	34	
730104	1/2" - 3/4"	1/2" - 3/4"	24	
730107	3/4" - 1"	3/4" - 1"	12	
730109	1" - 1-1/2"	1" - 1-1/2"	8	

UNIVERSAL REPAIRING TEE

Part No.	Universal	Universal	Universal	Box Qty.	Price
730301	3/8" - 1/2"	3/8" - 1/2"	3/8" - 1/2"	20	
730302	1/2" - 3/4"	3/8" - 1/2"	1/2" - 3/4"	12	
730303	1/2" - 3/4"	1/2" - 3/4"	1/2" - 3/4"	12	

Watch for (*) Additional fittings available upon request. Please call for special fitting requirements.

FLOPLAST POLYPROPYLENE UNIVERSAL COMPRESSION FITTINGS

Rating is 232 PSI from 68°F to 176°F

Watch for (*) Additional fittings available upon request. Please call for special fitting requirements.



UNIVERSAL REPAIRING FEMALE TEE *

Part No.	Universal	Thread NPT	Box Qty.	Price
730401	3/8" - 1/2"	1/2"	25	
730402	3/8" - 1/2"	3/4"	25	
730403	1/2" - 3/4"	3/4"	15	
730404	1/2" - 3/4"	1"	15	
730406	3/4" - 1"	1-1/4"	9	



UNIVERSAL TRANSITION FEMALE ADAPTER *

Part No.	Universal	Thread NPT	Box Qty.	Price
720020	3/8" - 1/2"	1/2"	60	
720025	1/2" - 3/4"	3/4"	35	
720026	1/2" - 3/4"	1"	35	
720032	3/4" - 1"	1"	25	
720041	1" - 1-1/2"	1-1/2"	25	



UNIVERSAL TRANSITION MALE ADAPTER *

Part No.	Universal	Thread NPT	Box Qty.	Price
721020	3/8" - 1/2"	1/2"	60	
721025	1/2" - 3/4"	3/4"	35	
721026	1/2" - 3/4"	1"	45	
721032	3/4" - 1"	1"	25	
721041	1" - 1-1/2"	1-1/2"	25	



UNIVERSAL X UNIVERSAL COMPRESSION VALVE

Part No.	Universal	Universal	Box Qty.	Price
140025U	3/8" - 1/2"	3/8" - 1/2"	28	
140032U	1/2" - 3/4"	1/2" - 3/4"	20	
140040U	3/4" - 1"	3/4" - 1"	12	
140050U	1" - 1-1/2"	1" - 1-1/2"	5	



DOUBLE PLASTIC WRENCH

Part No.	Size	Box Qty.	Price
776003	1/2" - 2"	50	



METALLIC WRENCH

Part No.	Size	Box Qty.	Price
776004	1-1/4" - 4"	10	

FloPlast Universal Fittings:

- Meet all requirements for mechanical fittings C-901 & C906-90
- Rating is 232 PSI for all fittings offered
- Maximum temperature is 176°F at 232 PSI
- Fittings install in minutes resulting in labor and equipment cost savings.
- Fittings can be used in new installation or in most repair/maintenance situations.
- FloPlast's Universal Coupling can connect Copper, PVC, Galvanized, Lead or HDPE on either end.
- FloPlast's Universal fittings are a great solution for repairs or new installations.
- SAVE ON COSTS—MAKE MORE PROFIT.

FloPlast Compression Fittings Proof of strength!

468# Steel Weights Suspended from 2" HDPE Pipe, 1-1/2" PVC Pipe and 1" Copper utilizing IPS & Universal Fittings



POLYMATE® ADAPTERS

Polymate® Adapters are patented fittings for repairing and transitioning polyethylene pipe. They are used with IPS - OD controlled polyethylene pipe and are designed to eliminate the need to fuse connections onto the pipe. Therefore, you can make a repair or transition without renting or purchasing expensive fusion equipment, and you can install these fittings in less than ideal weather conditions since installation is not affected by rain, extreme cold or fluid already in the pipeline. The Polymate® Adapters are available in IPS sizes from 1" to 6" diameter. Installation is simple! Just apply some lubricant to ease the installation process and screw the self threading connection onto your pipe. The Polymate® Adapters are available in 304 and 316 stainless steel and carbon steel. They offer exceptional quality and are completely reusable. The stainless steel fittings offer superior service and long-term performance that is unmatched. If you need a special fitting that is not listed, please let us know.

POLYMATE® SPLICER

Size	Carbon Steel		304 Stainless Steel		316 Stainless Steel	
	Part No.	Price	Part No.	Price	Part No.	Price
1"	PCS100SP		P304100SP		P316100SP	
1-1/4"	PCS125SP		P304125SP		P316125SP	
1-1/2"	PCS150SP		P304150SP		P316150SP	
2"	PCS200SP		P304200SP		P316200SP	
2-1/2"	-		P304250SP		-	
3"	PCS300SP		P304300SP		P316300SP	
4"	-		P304400SP		P316400SP	



POLYMATE® SPLICER TEE

Size	Part No.	Description	Price
1"	100SPT	Polymate® x Polymate® x Male Pipe Thread	
1-1/4"	125SPT	Polymate® x Polymate® x Male Pipe Thread	
2"	200SPT	Polymate® x Polymate® x Male Pipe Thread	



POLYMATE® MALE ADAPTER

Size	Carbon Steel		304 Stainless Steel		316 Stainless Steel	
	Part No.	Price	Part No.	Price	Part No.	Price
1"	PCS100TH		P304100TH		P316100TH	
1-1/4"	PCS125TH		P304125TH		P316125TH	
1-1/2"	PCS150TH		P304150TH		P316150TH	
2"	PCS200TH		P304200TH		P316200TH	
2-1/2"	-		P304250TH		P316250TH	
3"	PCS300TH		P304300TH		P316300TH	
4"	PCS400TH		P304400TH		P316400TH	
6"	-		P304600TH		P316600TH	



POLYMATE® GROOVED ADAPTER

Size	Carbon Steel		304 Stainless Steel		316 Stainless Steel	
	Part No.	Price	Part No.	Price	Part No.	Price
1"	-		P304100GV		-	
2"	PCS200GV		P304200GV		P316200GV	
3"	PCS300GV		P304300GV		P316300GV	
4"	PCS400GV		P304400GV		P316400GV	
6"	-		P304600GV		P316600GV	



INTRO
1. ELECTRICAL
2. PUMP Acc.
3. HOSE, PE Pipe & Acc.
4. IPS, PIP Pipe & Acc.
5. SURFACE
6. SPRINKLERS
7. TRAVELER & WHEEL MOVE
8. PIVOT
9. TURF
10. LOW VOLUME
11. FILTERS
12. INJECTION
13. HARDWARE
INDEX

POWER SEAL - HDPE REPAIR CLAMP

3121AS-PE STAINLESS STEEL SINGLE PANEL

Part No.	Pipe Size	Range In.	Letter Code	W = Width				
				8"	12"	16"	20"	24"
3121ASPE-1-1/4XW	1-1/4"	1.66	-					
3121ASPE-1-1/2XW	1-1/2"	1.88-1.92	-					
3121ASPE-2XW	2"	2.35-2.63	-					
3121ASPE-2-1/2W	2-1/2"	2.70-3.00	-					
3121ASPE-3AXW	3"	2.97-3.25	A					
3121ASPE-3BXW		3.46-3.70	B					
3121ASPE-3CXW		3.73-4.00	C					
3121ASPE-3DXW		3.96-4.25	D					
3121ASPE-4AXW	4"	4.45-4.73	A					
3121ASPE-4BXW		4.74-5.14	B					
3121ASPE-4CXW		4.95-5.35	C					
3121ASPE-4DXW		5.22-5.62	D					
3121ASPE-6AXW	6"	5.95-6.35	A					
3121ASPE-6BXW		6.56-6.96	B					
3121ASPE-6CXW		6.84-7.24	C					
3121ASPE-6DXW		7.05-7.45	D					
3121ASPE-6EXW	8"	7.45-7.85	E					
3121ASPE-8AXW		7.95-8.35	A					
3121ASPE-8BXW		8.54-8.94	B					
3121ASPE-8CXW		8.99-9.39	C					
3121ASPE-8DXW	10"	9.27-9.67	D					
3121ASPE-10AXW		9.70-10.10	A					
3121ASPE-10BXW		10.64-11.04	B					
3121ASPE-10CXW		11.04-11.44	C					
3121ASPE-10DXW	12"	11.34-11.74	D					
3121ASPE-10EXW		11.75-12.15	E					
3121ASPE-12AXW		12.00-12.40	A					
3121ASPE-12BXW		12.62-13.02	B					
3121ASPE-12CXW	12"	13.10-13.50	C					
3121ASPE-12DXW		13.40-13.80	D					
3121ASPE-12EXW		13.70-14.10	E					
3121ASPE-12FXW		14.00-14.40	F					



3121AS-PE



3122AS-PE

3122AS-PE STAINLESS STEEL DOUBLE PANEL

Part No.	Pipe Size	Range In.	Letter Code	W = Width						
				8"	10"	12"	16"	20"	24"	30"
3122ASPE-3XW	3"	3.49-4.29	-							
3122ASPE-4AXW	4"	4.44-5.24	A							
3122ASPE-4BXW		4.74-5.57	B							
3122ASPE-6AXW	6"	6.62-7.42	A							
3122ASPE-6BXW		6.84-7.64	B							
3122ASPE-8AXW	8"	8.62-9.42	A							
3122ASPE-8BXW		8.99-9.79	B							
3122ASPE-10AXW	10"	10.75-11.55	A							
3122ASPE-10BXW		11.10-11.90	B							
3122ASPE-10DXW		11.60-12.40	D							
3122ASPE-12AXW	12"	12.75-13.55	A							
3122ASPE-12BXW		13.20-14.00	B							
3122ASPE-12DXW		13.65-14.45	D							
3122ASPE-12FXW		14.00-14.80	F							
3122ASPE-14AXW	14"	14.38-15.13	A							
3122ASPE-14BXW		15.07-15.82	B							
3122ASPE-16AXW	16"	15.92-16.67	A							
3122ASPE-16BXW		16.56-17.31	B							
3122ASPE-16CXW		17.15-17.90	C							
3122ASPE-18AXW	18"	17.82-18.57	A							
3122ASPE-18BXW		18.46-19.21	B							
3122ASPE-18CXW		19.23-19.98	C							
3122ASPE-20AXW	20"	19.90-20.65	A							
3122ASPE-20BXW		20.70-21.45	B							
3122ASPE-22AXW	22"	21.52-22.27	A							
3122ASPE-22BXW		22.12-22.87	B							
3122ASPE-22CXW		22.90-23.65	C							

PIPE BARB INSERT MALE ADAPTERS AND COUPLINGS

Used with ID controlled Polyethylene Pipe.

PIPE BARB INSERT MALE ADAPTER

Size	Plated Steel		Bronze	
	Part No.	Price	Part No.	Price
1/2"	IGMA03		IBMA03	
3/4"	IGMA04		IBMA04	
1"	IGMA05		IBMA05	
1-1/4"	IGMA06		IBMA06	
1-1/2"	IGMA07		IBMA07	
2"	IGMA08		IBMA08	
2-1/2"	IGMA09		-	
3"	IGMA10		-	
4"	IGMA11		-	



PIPE BARB INSERT COUPLING

Size	Plated Steel		Bronze	
	Part No.	Price	Part No.	Price
1/2"	IGCP03		IBCP03	
3/4"	IGCP04		IBCP04	
1"	IGCP05		IBCP05	
1-1/4"	IGCP06		IBCP06	
1-1/2"	IGCP07		IBCP07	
2"	IGCP08		IBCP08	
2-1/2"	IGCP09		-	
3"	IGCP10		-	
4"	IGCP11		-	
6"	IGCP13		-	



CLAMPS & TOOLS

NOTE: Clamp sizes listed are generic & are intended only as a guide to direct you to the general area of the clamp size you're looking for. To select the proper clamp for your needs, compare the hose OD to the clamp range & select the clamp that best fits the outside diameter of your hose. If you would like some help with your selection, please give us a call.

CIMA WIRE CLAMPS

Part No.	Color Code	Size	Clamping Range		Price
CP15	Silver	5/8"	.906"	.968"	
CP16	Gold	3/4"	.969"	1.031"	
CP17	Red	3/4"	1.034"	1.090"	
CP18	Silver	1"	1.100"	1.150"	



OETIKER CLAMPS

Part No.	Reference No.	Size	Range Closed - Open		Price
15500007	145R	9/16"	.496"	.571"	
15500071	152R	19/32"	.496"	.598"	
15500008	157R	5/8"	.543"	.618"	
15500072	165R	21/32"	.547"	.650"	
15500009	170R	11/16"	.595"	.669"	
15500010	185R	23/32"	.618"	.728"	
15500011	198R	3/4"	.669"	.780"	
15500012	210R	13/16"	.717"	.827"	
15500013	226R	7/8"	.780"	.890"	
15500014	241R	15/16"	.839"	.949"	
15500015	256R	1"	.898"	1.008"	
15500016	271R	1-1/16"	.945"	1.067"	
15500017	286R	1-1/8"	1.004"	1.126"	
15500018	301R	1-3/16"	1.063"	1.185"	
15500019	316R	1-1/4"	1.122"	1.244"	
15500020	331R	1-5/16"	1.181"	1.303"	
15500021	346R	1-3/8"	1.240"	1.362"	
15500022	361R	1-7/16"	1.299"	1.421"	
15500023	376R	1-15/32"	1.358"	1.480"	
15500024	381R	1-1/2"	1.378"	1.500"	
15500025	396R	1-9/16"	1.437"	1.559"	
15500026	410R	1-5/8"	1.492"	1.614"	
15500027	425R	1-11/16"	1.551"	1.673"	

Additional size available upon request.

1-Ear stainless clamp with mechanical interlock.



OETIKER TOOLS

Part No.	Description	Qty. / Box	Price
14100082	Standard Jaw Pincers	6	
14100084	Long Handle Pincers	6	



MURRAY GOLD SEAL® WORM GEAR HOSE CLAMPS

This is a good general purpose worm gear hose clamp, with a perforated band and gold colored screw. The band & housing are 200/300 series stainless steel. The screw is 5/16" slotted hex head, heat treated carbon steel, double plated for lasting protection.

Part No.	Reference No.	Size	Clamping Range		Price
H600C	H6	1/2"	.44"	.78"	
H800C	H8	5/8"	.44"	.91"	
H1000C	H10	3/4"	.56"	1.06"	
H1200C	H12	1"	.69"	1.25"	
H1600C	H16	1-1/8"	.75"	1.50"	
H2000C	H20	1-1/4"	.81"	1.75"	
H2400C	H24	1-1/2"	1.06"	2.00"	
H2800C	H28	1-3/4"	1.31"	2.25"	
H3200C	H32	2"	1.56"	2.50"	
H3600C	H36	2-1/4"	1.81"	2.75"	
H4000C	H40	2-1/2"	2.06"	3.00"	
H4400C	H44	2-3/4"	2.31"	3.25"	



DIXON STAINLESS WORM GEAR HOSE CLAMPS

This all stainless steel clamp provides superior corrosion resistance in comparison to a clamp that is not all stainless steel. It is constructed of marine grade 300 series stainless band & housing with a 5/16" hexagon 305 series stainless slotted screw.

Part No.	Reference No.	Size	Clamping Range		Price
MAH4	-	7/16"	.22"	.62"	
MAH6	-	1/2"	.44"	.78"	
MAH8	-	5/8"	.44"	.91"	
HSS8	HF8SS	5/8"	.44"	.91"	
HSS10	HF10SS	3/4"	.56"	1.06"	
HSS12	HF12SS	1"	.69"	1.25"	
HSS16	HF16SS	1-1/8"	.75"	1.50"	
HSS20	HF20SS	1-1/4"	.81"	1.75"	
HSS24	HF24SS	1-1/2"	1.06"	2.00"	
HSS28	HF28SS	1-3/4"	1.31"	2.25"	
HSS32	HF32SS	2"	1.56"	2.50"	
HSS36	HF36SS	2-1/4"	1.81"	2.75"	
HSS40	HF40SS	2-1/2"	2.06"	3.00"	
HSS44	HF44SS	2-3/4"	2.31"	3.25"	
HSS48	HF48SS	3"	2.56"	3.50"	
HSS52	HF52SS	3-1/4"	2.81"	3.75"	
HSS56	HF56SS	3-1/2"	3.06"	4.00"	
HSS60	HF60SS	3-3/4"	3.31"	4.25"	
HSS64	HF64SS	4"	3.56"	4.50"	
HSS72	HF72SS	4-1/2"	4.06"	5.00"	
HSS80	HF80SS	5"	4.56"	5.50"	
HSS88	HF88SS	5-1/2"	5.06"	6.00"	
HSS96	HF96SS	6"	5.56"	6.50"	
HSS104	HF104SS	6-1/2"	6.06"	7.00"	
HSS128	HF128SS	7"	5.69"	8.50"	
HSS152	HF152SS	8-1/2"	7.19"	10.00"	
HSS188	HF188SS	11"	9.44"	12.25"	
HSS200	HF200SS	11-1/2"	10.19"	13.00"	
HSS212	HF212SS	12-1/4"	10.94"	13.75"	
HSS224	HF224SS	13"	11.69"	14.50"	
HSS312	HF312SS	18-1/2"	17.125"	20"	



CLAMPCO T-BOLT CLAMPS

Part No.	Reference No.	Size	Clamping Range		Price
94100-0125	TBC-1.25-0125	1.25"	1.11"	1.25"	
94100-0150	TBC-1.5-0150	1.5"	1.36"	1.50"	
94100-0162	TBC-1.5-0162	1.62"	1.48"	1.62"	
94100-0175	TBC-1.5-0175	1.75"	1.62"	1.87"	
94100-0188	TBC-1.5-0188	1.88"	1.75"	2.00"	
94100-0200	TBC-2-0200	2"	1.87"	2.12"	
94100-0212	TBC-2-0212	2.12"	1.93"	2.24"	
94100-0225	TBC-2-0225	2.25"	2.06"	2.37"	
94100-0238	TBC-2-0238	2.38"	2.19"	2.50"	
94100-0250	TBC-2.5-0250	2.50"	2.31"	2.62"	
94100-0256	TBC-2.5-0256	2.56"	2.37"	2.68"	
94100-0262	TBC-2.5-0262	2.62"	2.43"	2.74"	
94100-0275	TBC-2.5-0275	2.75"	2.56"	2.87"	
94100-0288	TBC-2.5-0288	2.88"	2.66"	2.97"	
94100-0300	TBC-3-0300	3"	2.78"	3.09"	
94100-0312	TBC-3-0312	3.12"	2.90"	3.21"	
94100-0325	TBC-3-0325	3.25"	3.03"	3.34"	
94100-0350	TBC-3-0350	3.50"	3.28"	3.59"	
94100-0375	TBC-3-0375	3.75"	3.53"	3.84"	
95130-0400	TBC-4-0400	4"	3.75"	4.15"	
95130-0425	TBC-4-0425	4.25"	4.03"	4.34"	
95130-0450	TBC-4-0450	4.50"	4.28"	4.59"	
95130-0475	TBC-4-0475	4.75"	4.52"	4.84"	
95130-0488	TBC-4-0488	4.88"	4.63"	5.03"	
95130-0500	TBC-5-0500	5"	4.78"	5.09"	
95130-0525	TBC-5-0525	5.25"	5.00"	5.40"	
95130-0531	TBC-5-0531	5.31"	5.06"	5.46"	
95130-0550	TBC-5-0550	5.50"	5.25"	5.65"	
95130-0556	TBC-5-0556	5.56"	5.31"	5.71"	
95130-0575	TBC-5-0575	5.75"	5.55"	5.90"	
95130-0600	TBC-5916-0600	6"	5.75"	6.15"	
95130-0618	TBC-6-0618	6.18"	5.93"	6.33"	
95130-0625	TBC-6-0625	6.25"	6.00"	6.40"	
95130-0644	TBC-6-0644	6.44"	6.19"	6.59"	
95130-0650	TBC-6.5-0650	6.50"	6.25"	6.65"	
95130-0656	TBC-6.5-0656	6.56"	6.31"	6.71"	
95130-0675	TBC-6.5-0675	6.75"	6.50"	6.90"	
95130-0688	TBC-6.5-0688	6.88"	6.63"	7.03"	
95130-0700	TBC-6.62-0700	7"	6.75"	7.15"	
95130-0706	TBC-6.62-0706	7.06"	6.81"	7.21"	
95130-0712	TBC-6.62-0712	7.12"	6.87"	7.27"	
95130-0725	TBC-6.62-0725	7.25"	7.00"	7.40"	
95130-0800	TBC-8-0800	8"	7.75"	8.15"	
95130-0844	TBC-8-0844	8.44"	8.19"	8.59"	
95130-0850	TBC-8-0850	8.50"	8.25"	8.65"	
95130-0856	TBC-8-0856	8.56"	8.31"	8.71"	
95130-0862	TBC-8-0862	8.62"	8.37"	8.77"	
95130-0870	TBC-8-0870	8.70"	8.45"	8.85"	
95130-0890	TBC-8-0890	8.90"	8.65"	9.05"	
95130-0918	TBC-8.62-0918	9.18"	8.93"	9.33"	
95130-0925	TBC-8.62-0925	9.25"	9.00"	9.40"	
95130-1044	TBC-10-1044	10.44"	10.19"	10.59"	
95130-1062	TBC-10-1062	10.62"	10.37"	10.77"	
95130-1075	TBC-10.75-1075	10.75"	10.50"	10.90"	
95130-1079	TBC-10.75-1079	10.79"	10.54"	10.94"	
95130-1090	TBC-10.75-1090	10.90"	10.65"	11.05"	



Good for medium & heavy-duty applications. Provides high tensile strength - higher clamping force than worm gear clamps. Manufactured with durable & corrosion resistant 300 series stainless steel. The solid band with rounded edges prevents damage from hose extrusion.

94100 Series clamp has a 3/4" wide band & 1/4" zinc plated T-Bolt with locknut.

95130 Series clamp has a 7/8" wide band & 5/16" zinc plated T-bolt with locknut.



REPLACEMENT NATIONAL FINE NYLON LOCK NUTS

Part No.	Size	Series	Price
NLN1/428	1/4"	94100	
NLN5/1624	5/16"	95130	

CENTER PUNCH CLAMPS

Part No.	Size	Price
KS4	1"	
KS5	1-1/4"	
KS6	1-1/2"	
KS7	1-3/4"	
KS8	2"	
KS9	2-1/4"	
KS10	2-1/2"	
KS11	2-3/4"	
KS12	3"	
KS14	3-1/2"	
KS16	4"	
KS18	4-1/2"	
KS20	5"	
KS24	6"	
KS28	7"	
KS32	8"	
F100	Tool	

F100 tool for 3/8" & 5/8" band clamps.

These universal preformed clamps are manufactured from 5/8" wide - .031" thick 300 series stainless steel for the clamp band & 302 series stainless steel for the clamp buckle.



SPIRAL DOUBLE BOLT CLAMPS

Part No.	Size	Price
SDBC-1.5	1-1/2"	
SDBC-2	2"	
SDBC-2.25	2-1/4"	
SDBC-2.5	2-1/2"	
SDBC-3	3"	
SDBC-3.5	3-1/2"	
SDBC-4	4"	
SDBC-5	5"	
SDBC-6	6"	
SDBC-8	8"	
SDBC-10	10"	
SDBC-12	12"	

Zinc plated carbon steel clamps for counterclockwise spiral. Specifically designed to fit PVC & rubber suction hose.



DUCTILE IRON DOUBLE BOLT CLAMPS

Part No.	Clamping Range	Price
DB76	2.3750" 3.0156"	
DB94	3.0312" 3.6875"	
DB400	3.5000" 4.0000"	
DB463	4.0625" 4.4375"	
DB525	4.1875" 5.0000"	
DB550	5.0000" 5.5000"	
DB600	5.5000" 6.0625"	
DB675	6.1250" 6.8750"	
DB769	6.9375" 7.6250"	
DB818	7.6875" 8.1875"	
DB875	8.2500" 8.8750"	
DB988	8.9375" 9.8750"	
DB1125	9.9375" 11.3750"	
DB1275	11.1875" 13.0000"	
DB1360	12.1875" 14.0000"	

A rugged, zinc plated ductile iron two bolt clamp with side saddles, machine bolts & hex nuts. Inner surface has dual gripping ridges. Bolt lugs are reinforced to prevent bending out of alignment.



DRAW BANDS

Cold rolled steel rod with rolled thread for maximum strength. Applications include clamping for fittings used with underground plastic pipe, transite pipe & hose material. Three sizes are available as indicated below:



REGULAR ID FOR 50 PSI PIPE

PAINTED ALL BLACK			
Part No.	Size	Clamp I.D.	Price
DBR4	4"	4.250"	
DBR5	5"	5.375"	
DBR6	6"	6.250"	
DBR8	8"	8.375"	
DBR10	10"	10.375"	
DBR12	12"	12.500"	
DBR14	14"	14.500"	
DBR15	15"	15.500"	
DBR16	16"	16.375"	
DBR18	18"	18.875"	
DBR21	21"	22.500"	
DBR24	24"	25.500"	



MEDIUM ID FOR 80 PSI - 100 PSI PIPE

PAINTED ALL BLACK WITH RED MARKINGS			
Part No.	Size	Clamp I.D.	Price
DBS4	4"	4.625"	
DBS6	6"	6.375"	
DBS8	8"	8.500"	
DBS10	10"	10.500"	



LARGE ID FOR IPS PIPE

PAINTED ALL BLACK WITH SILVER MARKINGS			
Part No.	Size	Clamp I.D.	Price
DBL4	4"	4.750"	
DBL6	6"	6.750"	
DBL8	8"	8.750"	
DBL10	10"	11.000"	
DBL12	12"	13.000"	
DBL15	15"	16.000"	
DBL16	16"	16.750"	



Note: Draw Bands are pre-packaged in bundles of 10, although we will break bundle quantities depending upon your needs.

- INTRO
- 1. ELECTRICAL
- 2. PUMP ACC.
- 3. HOSE, PE PIPE & ACC.
- 4. IPS, PIP PIPE & ACC.
- 5. SURFACE
- 6. SPRINKLERS
- 7. TRAVELER & WHEEL MOVE
- 8. PIVOT
- 9. TURF
- 10. LOW VOLUME
- 11. FILTERS
- 12. INJECTION
- 13. HARDWARE
- INDEX

PATCH CLAMPS

6" WIDE - 2 BOLT FOR IPS PIPE

Part No.	Pipe Size	Box Qty.	Price
330-026	3/8"	3	
330-036	1/2"	3	
330-046	3/4"	3	
330-056	1"	3	
330-066	1-1/4"	3	
330-076	1-1/2"	3	
330-086	2"	2	
330-096	2-1/2"	2	
330-106	3"	2	
330-1056	3-1/2"	1	
330-116	4"	1	
330-126	5"	1	
330-136	6"	1	
330-1356	7"	1	
330-146	8"	1	
330-156	10"	1	
330-166	12"	1	
330-176	14"	1	
330-186	16"	1	
330-196	18"	1	



9" WIDE - 3 BOLT FOR IPS PIPE

Part No.	Pipe Size	Box Qty.	Price
330-029	3/8"	4	
330-039	1/2"	4	
330-049	3/4"	4	
330-059	1"	4	
330-069	1-1/4"	4	
330-079	1-1/2"	3	
330-089	2"	3	
330-099	2-1/2"	1	
330-109	3"	1	
330-1059	3-1/2"	1	
330-119	4"	1	
330-129	5"	1	
330-139	6"	1	
330-1359	7"	1	
330-149	8"	1	
330-159	10"	1	
330-169	12"	1	
330-179	14"	1	
330-189	16"	1	
330-199	18"	1	



12" WIDE - 4 BOLT FOR IPS PIPE

Part No.	Pipe Size	Box Qty.	Price
330-0212	3/8"	4	
330-0312	1/2"	4	
330-0412	3/4"	4	
330-0512	1"	4	
330-0612	1-1/4"	4	
330-0712	1-1/2"	3	
330-0812	2"	3	
330-0912	2-1/2"	2	
330-1012	3"	2	
330-10512	3-1/2"	1	
330-1112	4"	1	
330-1212	5"	1	
330-1312	6"	1	
330-13512	7"	1	
330-1412	8"	1	
330-1512	10"	1	
330-1612	12"	1	
330-1712	14"	1	
330-1812	16"	1	
330-1912	18"	1	



6" WIDE - 2 BOLT FOR O.D. & PIP PIPE

Part No.	Pipe Size	Box Qty.	Price
330-086-OD	2"	2	
330-096-OD	2-1/2"	2	
330-106-OD	3"	2	
330-1056-OD	3-1/2"	1	
330-116-OD	4"	1	
330-126-OD	5"	1	
330-136-OD	6"	1	
330-1356-OD	7"	1	
330-146-OD	8"	1	
330-156-OD	10"	1	
330-166-OD	12"	1	



9" WIDE - 3 BOLT FOR O.D. & PIP PIPE

Part No.	Pipe Size	Box Qty.	Price
330-089-OD	2"	3	
330-099-OD	2-1/2"	1	
330-109-OD	3"	1	
330-1059-OD	3-1/2"	1	
330-119-OD	4"	1	
330-129-OD	5"	1	
330-139-OD	6"	1	
330-1359-OD	7"	1	
330-149-OD	8"	1	
330-159-OD	10"	1	
330-169-OD	12"	1	



12" WIDE - 4 BOLT FOR O.D. & PIP PIPE

Part No.	Pipe Size	Box Qty.	Price
330-0812-OD	2"	3	
330-0912-OD	2-1/2"	2	
330-1012-OD	3"	2	
330-10512-OD	3-1/2"	1	
330-1112-OD	4"	1	
330-1212-OD	5"	1	
330-1312-OD	6"	1	
330-13512-OD	7"	1	
330-1412-OD	8"	1	
330-1512-OD	10"	1	
330-1612-OD	12"	1	



INTRO
1. ELECTRICAL
2. PUMP Acc.
3. HOSE, PE Pipe & Acc.
4. IPS, PIP Pipe & Acc.
5. SURFACE
6. SPRINKLERS
7. TRAVELER & WHEEL MOVE
8. PIVOT
9. TURF
10. LOW VOLUME
11. FILTERS
12. INJECTION
13. HARDWARE
INDEX

SECTION 4

PVC PIP & IPS PIPE & Accessories

CONTENTS

4:3	PIPE NOTES
4:4	PVC PLASTIC IRRIGATION PIPE
4:4	PVC PIP PLASTIC IRRIGATION PIPE
4:4	PVC IPS PLASTIC IRRIGATION PIPE
4:5	PVC PLASTIC IRRIGATION PIPE
4:5	PVC IPS PLASTIC IRRIGATION PIPE
4:6-10	PVC PIP FABRICATED SOLVENT WELD FITTINGS
4:11-13	PVC PIP FABRICATED GASKETED FITTINGS
4:14-17	PVC IPS FABRICATED SOLVENT WELD FITTINGS
4:17-20	PVC IPS FABRICATED GASKETED FITTINGS
4:21-26	SCHEDULE 40 PVC FITTINGS
4:27	ULTRAVIOLET RESISTANT SCHEDULE 40 PVC FITTINGS
4:28	PVC CLEAR SCHEDULE 40 PIPE & FITTINGS
4:29-33	SCHEDULE 80 PVC FITTINGS
4:34	PVC SCHEDULE 80 NIPPLES
4:35	PVC SCHEDULE 80 GROOVED NIPPLES
4:36-37	PLASTIC PIPE CEMENTS, PRIMERS & ACCESSORIES
4:38	PLASTIC PIPE SEALANTS & HAND CLEANERS
4:39	PLASTIC PIPE CUTTING TOOLS
4:40-48	IPS EPOXY FITTINGS
4:49-55	PIP EPOXY FITTINGS
4:56-58	STEEL SADDLE
4:59-62	BOLT TITE & WEDGE-TITE® FITTINGS
4:63-66	BOLTED REPAIR COUPLINGS
4:67	TRANSITIONAL BOLTED REPAIR COUPLINGS
4:67	POWER SEAL HEAVY DUTY CAST IRON BOLTED TRANSITION COUPLING
4:68	PIPE REPAIR CLAMPS
4:69	IPS PATCH CLAMPS
4:70	O.D. & PIP PATCH CLAMPS
4:71	O.D. PATCH CLAMPS & FLEXIBLE RUBBER COUPLINGS
4:71	FLEXIBLE RUBBER PIPE COUPLING WITH STAINLESS STEEL BANDS



PVC PLASTIC IRRIGATION PIPE

PVC PIP PLASTIC IRRIGATION PIPE

SDR-81 50 PSI - GASKETED JOINT

Part No.	Size	Nominal O.D.	Nominal I.D.	Lbs. / 100'	Ft. / Joint	Pieces / Lift	Feet / Lift
P06005044G	6"	6.14"	5.988"	98.73	44'	28 / 32	1232' / 1408'
P08005044G	8"	8.16"	7.958"	174.47	44'	18	792'
P10005044G	10"	10.20"	9.948"	272.63	44'	12 / 15	528' / 660'
P12005044G	12"	12.24"	11.938"	385.07	44'	8	352'
P15005022G	15"	15.30"	14.922"	605.85	22'	6	132'



**Please Call
for Pricing**

SDR-51 80 PSI - GASKETED JOINT

Part No.	Size	Nominal O.D.	Nominal I.D.	Lbs. / 100'	Ft. / Joint	Pieces / Lift	Feet / Lift
P06008044G	6"	6.14"	5.898"	156.60	22' / 44'	32	704' / 1408'
P08008044G	8"	8.16"	7.840"	272.51	22' / 44'	18	396' / 792'
P10008022G	10"	10.20"	9.800"	423.41	22'	15	330'
P12008022G	12"	12.24"	11.760"	610.95	22'	8 / 12	176' / 264'
P15008022G	15"	15.30"	14.700"	954.61	22'	6	132'

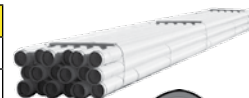

**Please Call
for Pricing**

SDR-41 100 PSI - GASKETED JOINT

Part No.	Size	Nominal O.D.	Nominal I.D.	Lbs. / 100'	Ft. / Joint	Pieces / Lift	Feet / Lift
P06010022G	6"	6.14"	5.840"	191.09	22'	32	704'
P08010022G	8"	8.16"	7.762"	334.04	22'	18	396'
P10010022G	10"	10.20"	9.702"	524.57	22'	15	330'
P12010022G	12"	12.24"	11.642"	757.40	22'	8 / 12	176' / 264'
P15010022G	15"	15.30"	14.550"	1,181.12	22'	6	132'



**Please Call
for Pricing**

SDR-32.5 125 PSI - GASKETED JOINT

Part No.	Size	Nominal O.D.	Nominal I.D.	Lbs. / 100'	Ft. / Joint	Pieces / Lift	Feet / Lift
P06012522G	6"	6.14"	5.762"	236.91	22'	32	704'
P08012522G	8"	8.16"	7.658"	418.57	22'	18	396'
P10012522G	10"	10.20"	9.572"	657.18	22'	12 / 15	264' / 330'
P12012522G	12"	12.24"	11.486"	948.74	22'	8	176'
P15012522G	15"	15.30"	14.358"	1,481.65	22'	6	132'



**Please Call
for Pricing**

PVC IPS PLASTIC IRRIGATION PIPE

SDR-41 100 PSI - WHITE - BELLED END

Part No.	Size	Nominal O.D.	Nominal I.D.	Lbs. / 100'	Ft. / Joint	Pieces / Lift	Feet / Lift
510	2"	2.375"	2.255"	30.70	20'	210	4,200'
540	2"	2.375"	2.255"	30.70	40'	105	4,200'
514	3"	3.500"	3.330"	62.00	20'	104	2,080'
542	3"	3.500"	3.330"	62.00	40'	52	2,080'
516	4"	4.500"	4.280"	100.00	20'	60	1,200'
544	4"	4.500"	4.280"	100.00	40'	30	1,200'
PI04040100L	4"	4.500"	4.280"	100.00	40'	48	1,920'



**Please Call
for Pricing**

SDR-26 160 PSI - WHITE - BELLED END

Part No.	Size	Nominal O.D.	Nominal I.D.	Lbs. / 100'	Ft. / Joint	Pieces / Lift	Feet / Lift
32.122	1-1/4"	1.660"	1.532"	21	20'	250	5,000'
378	1-1/4"	1.660"	1.532"	21	40'	210	8,400'
32.152	1-1/2"	1.900"	1.754"	28	20'	225	4,500'
380	1-1/2"	1.900"	1.754"	28	40'	180	7,200'
32.202	2"	2.375"	2.193"	42	20'	140	2,800'
382	2"	2.375"	2.193"	42	40'	105	4,200'
32.252	2-1/2"	2.875"	2.655"	61	20'	116	2,320'
32.302	3"	3.500"	3.230"	93	20'	75	1,500'
32.402	4"	4.500"	4.154"	156	20'	57	1,140'
32.502	5"	5.563"	5.135"	240	20'	20	460'
32.602	6"	6.625"	6.115"	320	20'	26	520'
35.802	8"	8.625"	7.981"	546	20'	14	280'



**Please Call
for Pricing**

PVC PLASTIC IRRIGATION PIPE

PVC IPS PLASTIC IRRIGATION PIPE

SDR-21 200 PSI - WHITE - BELLED END - 20 FT. LENGTH

Part No.	Size	Wall Thickness	Nominal O.D.	Nominal I.D.	Lbs. / 100'	Pieces / Lift	Feet / Lift
34.052	1/2"	0.062"	0.840"	0.716"	10	480	9,600'
34.072	3/4"	0.060"	1.050"	0.930"	12	400	8,000'
34.102	1"	0.063"	1.315"	1.189"	16	390	7,800'
34.122	1-1/4"	0.079"	1.660"	1.502"	25	250	5,000'
34.152	1-1/2"	0.090"	1.900"	1.720"	33	225	4,500'
34.202	2"	0.113"	2.375"	2.149"	53	140	2,800'
34.252	2-1/2"	0.137"	2.875"	2.601"	74	116	2,320'
34.302	3"	0.167"	3.500"	3.166"	114	75	1,500'
34.402	4"	0.214"	4.500"	4.072"	189	57	1,140'
34.502	5"	0.265"	5.563"	5.033"	295	23	460'
34.602	6"	0.316"	6.625"	5.993"	390	26	520'

Note: The 1/2" Pipe listed above is actually rated & marked for 315 PSI



**Please Call
for Pricing**

SCHEDULE 40 - WHITE - BELLED END - 20 FT. LENGTH

Part No.	Size	Working PSI	Nominal O.D.	Nominal I.D.	Lbs. / 100'	Pieces / Lift	Feet / Lift
35.052	1/2"	600	0.840"	0.622"	16	480	9,600'
35.072	3/4"	480	1.050"	0.824"	22	400	8,000'
35.102	1"	450	1.315"	1.049"	32	260	5,200'
35.122	1-1/4"	370	1.660"	1.380"	42	250	5,000'
35.152	1-1/2"	330	1.900"	1.610"	51	225	4,500'
35.202	2"	280	2.375"	2.067"	70	140	2,800'
35.252	2-1/2"	300	2.875"	2.469"	108	116	2,320'
35.302	3"	260	3.500"	3.068"	144	75	1,500'
35.402	4"	220	4.500"	4.026"	205	57	1,140'
35.502	5"	190	5.563"	5.047"	288	23	460'
35.602	6"	180	6.625"	6.065"	364	26	520'
35.802	8"	160	8.625"	7.981"	546	14	280'
35.910	10"	140	10.750"	10.02"	753	11	220'
35.912	12"	130	12.750"	11.938"	1000	4	80'



**Please Call
for Pricing**

SCHEDULE 80 - GRAY - PLAIN END - 20 FT. LENGTH

Part No.	Size	Working PSI	Nominal O.D.	Nominal I.D.	Lbs. / 100'	Pieces / Lift	Feet / Lift
16.050	1/2"	850	0.840"	0.546"	20	480	9,600'
16.070	3/4"	690	1.050"	0.742"	27	400	8,000'
16.100	1"	630	1.315"	0.957"	40	260	5,200'
16.120	1-1/4"	520	1.660"	1.278"	55	250	5,000'
16.150	1-1/2"	470	1.900"	1.500"	68	225	4,500'
16.200	2"	400	2.375"	1.939"	94	70	1,400'
17.250	2-1/2"	420	2.875"	2.323"	144	58	1,160'
17.300	3"	370	3.500"	2.900"	194	38	760'
17.400	4"	320	4.500"	3.826"	286	29	580'
17.500	5"	290	5.563"	4.813"	397	13	260'
17.600	6"	280	6.625"	5.761"	545	13	260'



**Please Call
for Pricing**

SCHEDULE 40 - CLEAR - PLAIN END - 10 FT. LENGTH

Part No.	Size	Working PSI	Nominal O.D.	Nominal I.D.	Lbs. / 100'	Pieces / Lift	Feet / Lift
PL-005	1/2"	600	0.840"	0.608"	16	35	350'
PL-007	3/4"	480	1.050"	0.810"	22	25	250'
PL-010	1"	450	1.315"	1.033"	32	25	250'
PL-012	1-1/4"	370	1.660"	1.364"	43	20	200'
PL-015	1-1/2"	330	1.900"	1.592"	51	16	160'
PL-020	2"	280	2.375"	2.049"	69	12	120'
PL-025	2-1/2"	300	2.875"	2.445"	108	8	80'
PL-030	3"	260	3.500"	3.042"	141	6	60'
PL-040	4"	220	4.500"	3.998"	201	5	50'
PL-060	6"	180	6.625"	6.031"	354	1	10'
PL-080	8"	160	8.625"	7.943"	531	1	10'



**Please Call
for Pricing**

INTRO
 1. ELECTRICAL
 2. PUMP ACC.
 3. HOSE, PE PIPE & ACC.
 4. IPS PIP PIPE & ACC.
 5. SURFACE
 6. SPRINKLERS
 7. TRAVELER & WHEEL MOVE
 8. PIVOT
 9. TURF
 10. LOW VOLUME
 11. FILTERS
 12. INJECTION
 13. HARDWARE
 INDEX

PVC PIP FABRICATED SOLVENT WELD FITTINGS

PIP X IPS ADAPTER - 125 PSI

Size Inches	Female PIP x Male IPS		Female PIP x Female IPS		Bushing Style	
	Part No.	Price	Part No.	Price	Part No.	Price
4	PIPSAD000		-		PIPSAD000	
6	PIPSAD001		PIPSAD003		431-060	
8	PIPSAD051		PIPSAD053		431-080	
10	PIPSAD101		PIPSAD103		431-100	
12	PIPSAD151		PIPSAD153		431-120	



PIP AIR RELIEF VALVE ADAPTER

Size Inches	50 PSI		100 PSI	
	Part No.	Price	Part No.	Price
6 x 2	-		PIPSAR003	
6 x 3	-		PIPSAR007	
8 x 2	-		PIPSAR053	
8 x 3	-		PIPSAR057	
10 x 2	-		PIPSAR103	
10 x 3	-		PIPSAR107	
10 x 4	-		PIPSAR109	
12 x 3	PIPSAR157		PIPSAR158	
12 x 4	PIPSAR159		PIPSAR161	
15 x 4	PIPSAR259		PIPSAR261	



PIP CAP

Size Inches	50 PSI		100 PSI		125 PSI	
	Part No.	Price	Part No.	Price	Part No.	Price
6	PIPSCA001		PIPSCA003		PIPSCA003-1	
8	PIPSCA051		PIPSCA053		-	
10	PIPSCA101		PIPSCA103		-	
12	PIPSCA151		PIPSCA153		-	
15	PIPSCA251		PIPSCA253		-	



PIP COUPLING

Size Inches	50 PSI		80 PSI		100 PSI		125 PSI	
	Part No.	Price	Part No.	Price	Part No.	Price	Part No.	Price
6	-		PIPSCO002		PIPSCO003		PIPSCO003-1	
8	PIPSCO051		PIPSCO052		PIPSCO053		PIPSCO053-1	
10	PIPSCO101		PIPSCO102		PIPSCO103		PIPSCO103-1	
12	PIPSCO151		PIPSCO152		PIPSCO153		PIPSCO153-1	
15	PIPSCO251		PIPSCO252		PIPSCO253		PIPSCO253-1	



PIP CROSS

Size Inches	50 PSI		80 PSI		100 PSI	
	Part No.	Price	Part No.	Price	Part No.	Price
6 x 2	-		PIPSCR002		PIPSCR003	
6 x 3	-		PIPSCR006		PIPSCR007	
6 x 4	-		PIPSCR010		PIPSCR011	
6 x 6	-		PIPSCR014		PIPSCR015	
8 x 2	-		PIPSCR052		PIPSCR053	
8 x 3	-		PIPSCR056		PIPSCR057	
8 x 4	-		PIPSCR060		PIPSCR061	
8 x 6	-		PIPSCR064		PIPSCR065	
8 x 8	-		PIPSCR068		PIPSCR069	
10 x 2	-		PIPSCR102		PIPSCR103	
10 x 3	-		PIPSCR106		PIPSCR107	
10 x 4	-		PIPSCR110		PIPSCR111	
10 x 6	-		PIPSCR114		PIPSCR115	
10 x 8	-		PIPSCR118		PIPSCR119	
10 x 10	-		PIPSCR121		PIPSCR122	



Note: These are special order & NON-RETURNABLE.

CONTINUED NEXT PAGE

PVC PIP FABRICATED SOLVENT WELD FITTINGS

PIP CROSS - CONTINUED

Size Inches	50 PSI		80 PSI		100 PSI	
	Part No.	Price	Part No.	Price	Part No.	Price
12 x 2	PIPSCR151		PIPSCR152		PIPSCR153	
12 x 3	PIPSCR155		PIPSCR156		PIPSCR157	
12 x 4	PIPSCR159		PIPSCR160		PIPSCR161	
12 x 6	PIPSCR162		PIPSCR164		PIPSCR165	
12 x 8	PIPSCR167		PIPSCR168		PIPSCR169	
12 x 10	PIPSCR170		PIPSCR172		PIPSCR173	
12 x 12	PIPSCR175		PIPSCR176		PIPSCR177	
15 x 2	PIPSCR251		PIPSCR252		PIPSCR253	
15 x 3	PIPSCR255		PIPSCR256		PIPSCR257	
15 x 4	PIPSCR259		PIPSCR260		PIPSCR261	
15 x 6	PIPSCR263		PIPSCR264		PIPSCR265	
15 x 8	PIPSCR267		PIPSCR268		PIPSCR269	
15 x 10	PIPSCR271		PIPSCR272		PIPSCR273	
15 x 12	PIPSCR275		PIPSCR276		PIPSCR277	
15 x 15	PIPSCR287		PIPSCR288		PIPSCR289	



Note: These are special order & NON-RETURNABLE.

PIP ELBOW

Size In. x Deg.	50 PSI		80 PSI		100 PSI		125 PSI	
	Part No.	Price	Part No.	Price	Part No.	Price	Part No.	Price
6 x 11°	-	-	PIPSEL002		PIPSEL003		PIPSEL003-1	
6 x 22°	-	-	PIPSEL010		PIPSEL011		PIPSEL011-1	
6 x 30°	-	-	PIPSEL014		PIPSEL015		PIPSEL015-1	
6 x 45°	-	-	PIPSEL018		PIPSEL019		PIPSEL019-1	
6 x 90°	-	-	PIPSEL026		PIPSEL027		PIPSEL027-1	
8 x 11°	-	-	PIPSEL052		PIPSEL053		PIPSEL053-1	
8 x 22°	-	-	PIPSEL060		PIPSEL061		PIPSEL061-1	
8 x 30°	-	-	PIPSEL064		PIPSEL065		PIPSEL065-1	
8 x 45°	-	-	PIPSEL068		PIPSEL069		PIPSEL069-1	
8 x 90°	-	-	PIPSEL076		PIPSEL077		PIPSEL077-1	
10 x 11°	-	-	PIPSEL102		PIPSEL103		PIPSEL103-1	
10 x 22°	-	-	PIPSEL110		PIPSEL111		PIPSEL111-1	
10 x 30°	-	-	PIPSEL114		PIPSEL115		PIPSEL115-1	
10 x 45°	-	-	PIPSEL118		PIPSEL119		PIPSEL119-1	
10 x 90°	-	-	PIPSEL126		PIPSEL127		PIPSEL127-1	
12 x 11°	PIPSEL151		PIPSEL152		PIPSEL153		PIPSEL153-1	
12 x 22°	PIPSEL159		PIPSEL160		PIPSEL161		PIPSEL161-1	
12 x 30°	PIPSEL163		PIPSEL164		PIPSEL165		PIPSEL165-1	
12 x 45°	PIPSEL167		PIPSEL168		PIPSEL169		PIPSEL169-1	
12 x 90°	PIPSEL175		PIPSEL176		PIPSEL177		PIPSEL177-1	
15 x 11°	PIPSEL251		PIPSEL252		PIPSEL253		PIPSEL253-1	
15 x 22°	PIPSEL259		PIPSEL260		PIPSEL261		PIPSEL261-1	
15 x 30°	PIPSEL263		PIPSEL264		PIPSEL265		PIPSEL265-1	
15 x 45°	PIPSEL267		PIPSEL268		PIPSEL269		PIPSEL269-1	
15 x 90°	PIPSEL275		PIPSEL276		PIPSEL277		PIPSEL277-1	



PIP FEMALE ADAPTER

Size Inches	125 PSI	
	Part No.	Price
6	PIPSFE001	
8	PIPSFE051	
10	PIPSFE101	
12	PIPSFE151	



PIP VAN STONE FLANGE

Size Inches	125 PSI	
	Part No.	Price
6	354-060F	
8	354-080F	
10	354-100F	
12	354-120F	



Note: Larger Sizes Available

INTRO
1. ELECTRICAL
2. PUMP ACC.
3. HOSE, PE PIPE & ACC.
4. IPSI PIP PIPE & ACC.
5. SURFACE
6. SPRINKLERS
7. TRAVELER & WHEEL MOVE
8. PIVOT
9. TURF
10. LOW VOLUME
11. FILTERS
12. INJECTION
13. HARDWARE
INDEX

PVC PIP FABRICATED SOLVENT WELD FITTINGS

PIP REPAIR INSERT

Size Inches	80 PSI	
	Part No.	Price
6 x 15	PIPSIN001	
8 x 15	PIPSIN051	
10 x 15	PIPSIN101	
12 x 15	PIPSIN151	
15 x 15	PIPSIN251	



PIP MALE ADAPTER

Size Inches	125 PSI	
	Part No.	Price
6	PIPSMA001	
8	PIPSMA051	
10	PIPSMA101	
12	PIPSMA151	

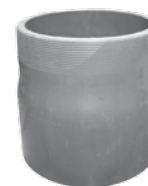

PIP REDUCING COUPLING

Size Inches	50 PSI		100 PSI		125 PSI	
	Part No.	Price	Part No.	Price	Part No.	Price
6 x 2	-		PIPSRE003		PIPSRE003-1	
6 x 3	-		PIPSRE007		PIPSRE007-1	
6 x 4	-		PIPSRE011		PIPSRE011-1	
8 x 2	-		PIPSRE053		PIPSRE053-1	
8 x 3	-		PIPSRE057		PIPSRE057-1	
8 x 4	-		PIPSRE061		PIPSRE061-1	
8 x 6	-		PIPSRE065		PIPSRE065-1	
10 x 2	-		PIPSRE103		PIPSRE103-1	
10 x 3	-		PIPSRE107		PIPSRE107-1	
10 x 4	-		PIPSRE111		PIPSRE111-1	
10 x 6	-		PIPSRE115		PIPSRE115-1	
10 x 8	-		PIPSRE119		PIPSRE119-1	
12 x 2	-		PIPSRE153		PIPSRE153-1	
12 x 3	-		PIPSRE157		PIPSRE157-1	
12 x 4	-		PIPSRE161		PIPSRE161-1	
12 x 6	-		PIPSRE165		PIPSRE165-1	
12 x 8	PIPSRE167		PIPSRE169		PIPSRE169-1	
12 x 10	PIPSRE171		PIPSRE173		PIPSRE173-1	
15 x 2	-		PIPSRE253		PIPSRE253-1	
15 x 3	-		PIPSRE257		PIPSRE257-1	
15 x 4	-		PIPSRE261		PIPSRE261-1	
15 x 6	-		PIPSRE265		PIPSRE265-1	
15 x 8	-		PIPSRE269		PIPSRE269-1	
15 x 10	-		PIPSRE273		PIPSRE273-1	
15 x 12	PIPSRE275		PIPSRE277		PIPSRE277-1	



PIP RISER TEE - SLIP X SLIP X NPT

Size Inches	100 PSI		125 PSI	
	Part No.	Price	Part No.	Price
6 x 2	PIPSRT003		PIPSRT003-1	
6 x 3	PIPSRT007		PIPSRT007-1	
6 x 4	PIPSRT011		PIPSRT011-1	
8 x 2	PIPSRT052		PIPSRT052-1	
8 x 3	PIPSRT056		PIPSRT056-1	
8 x 4	PIPSRT061		PIPSRT061-1	
10 x 2	PIPSRT102		PIPSRT102-1	
10 x 3	PIPSRT107		PIPSRT107-1	
10 x 4	PIPSRT111		PIPSRT111-1	
12 x 2	PIPSRT153		PIPSRT153-1	
12 x 3	PIPSRT157		PIPSRT157-1	
12 x 4	PIPSRT160		PIPSRT160-1	
15 x 2	PIPSRT252		PIPSRT252-1	
15 x 3	PIPSRT256		PIPSRT256-1	
15 x 4	PIPSRT260		PIPSRT260-1	



Note: These are special order & NON-RETURNABLE.

PVC PIP FABRICATED SOLVENT WELD FITTINGS

PIP SADDLE TEE

Size Inches	50 PSI		100 PSI		125 PSI	
	Part No.	Price	Part No.	Price	Part No.	Price
6 x 2	-		PIPSSA003		PIPSSA003-1	
6 x 3	-		PIPSSA007		PIPSSA007-1	
6 x 4	-		PIPSSA011		PIPSSA011-1	
6 x 6	-		PIPSSA015		PIPSSA015-1	
8 x 2	-		PIPSSA053		PIPSSA053-1	
8 x 3	-		PIPSSA057		PIPSSA057-1	
8 x 4	-		PIPSSA061		PIPSSA061-1	
8 x 6	-		PIPSSA065		PIPSSA065-1	
8 x 8	-		PIPSSA068		PIPSSA068-1	
10 x 2	-		PIPSSA103		PIPSSA103-1	
10 x 3	-		PIPSSA107		PIPSSA107-1	
10 x 4	-		PIPSSA111		PIPSSA111-1	
10 x 6	-		PIPSSA115		PIPSSA115-1	
10 x 8	-		PIPSSA119		PIPSSA119-1	
10 x 10	-		PIPSSA123		PIPSSA123-1	
12 x 2	PIPSSA151		PIPSSA153		PIPSSA153-1	
12 x 3	PIPSSA155		PIPSSA157		PIPSSA157-1	
12 x 4	PIPSSA159		PIPSSA161		PIPSSA161-1	
12 x 6	PIPSSA163		PIPSSA165		PIPSSA165-1	
12 x 8	PIPSSA167		PIPSSA169		PIPSSA170-1	
12 x 10	PIPSSA171		PIPSSA173		PIPSSA173-1	
12 x 12	PIPSSA175		PIPSSA177		PIPSSA177-1	
15 x 2	PIPSSA251		PIPSSA253		PIPSSA253-1	
15 x 3	PIPSSA255		PIPSSA257		PIPSSA257-1	
15 x 4	PIPSSA259		PIPSSA261		PIPSSA261-1	
15 x 6	PIPSSA263		PIPSSA265		PIPSSA265-1	
15 x 8	PIPSSA267		PIPSSA269		PIPSSA269-1	
15 x 10	PIPSSA271		PIPSSA273		PIPSSA273-1	
15 x 12	PIPSSA275		PIPSSA277		PIPSSA277-1	



Note: These are special order & NON-RETURNABLE.

PIP TEE

Size Inches	50 PSI		80 PSI		100 PSI		125 PSI	
	Part No.	Price	Part No.	Price	Part No.	Price	Part No.	Price
6 x 2	-		PIPSTE002		PIPSTE003		PIPSTE003-1	
6 x 3	-		PIPSTE006		PIPSTE007		PIPSTE007-1	
6 x 4	-		PIPSTE010		PIPSTE011		PIPSTE011-1	
6 x 6	-		PIPSTE014		PIPSTE015		PIPSTE015-1	
8 x 2	-		PIPSTE052		PIPSTE053		PIPSTE053-1	
8 x 3	-		PIPSTE056		PIPSTE057		PIPSTE057-1	
8 x 4	-		PIPSTE060		PIPSTE061		PIPSTE061-1	
8 x 6	-		PIPSTE064		PIPSTE065		PIPSTE065-1	
8 x 8	-		PIPSTE068		PIPSTE069		PIPSTE069-1	
10 x 2	-		PIPSTE102		PIPSTE103		PIPSTE103-1	
10 x 3	-		PIPSTE106		PIPSTE107		PIPSTE107-1	
10 x 4	-		PIPSTE110		PIPSTE111		PIPSTE111-1	
10 x 6	-		PIPSTE114		PIPSTE115		PIPSTE115-1	
10 x 8	-		PIPSTE118		PIPSTE119		PIPSTE119-1	
10 x 10	-		PIPSTE122		PIPSTE123		PIPSTE123-1	
12 x 2	PIPSTE151		PIPSTE152		PIPSTE153		PIPSTE153-1	
12 x 3	PIPSTE155		PIPSTE156		PIPSTE157		PIPSTE157-1	
12 x 4	PIPSTE159		PIPSTE160		PIPSTE161		PIPSTE161-1	
12 x 6	PIPSTE163		PIPSTE164		PIPSTE165		PIPSTE165-1	
12 x 8	PIPSTE167		PIPSTE168		PIPSTE169		PIPSTE169-1	
12 x 10	PIPSTE171		PIPSTE172		PIPSTE173		PIPSTE173-1	
12 x 12	PIPSTE175		PIPSTE176		PIPSTE177		PIPSTE177-1	
15 x 2	PIPSTE251		PIPSTE252		PIPSTE253		PIPSTE253-1	
15 x 3	PIPSTE255		PIPSTE256		PIPSTE257		PIPSTE257-1	
15 x 4	PIPSTE259		PIPSTE260		PIPSTE261		PIPSTE261-1	
15 x 6	PIPSTE263		PIPSTE264		PIPSTE265		PIPSTE265-1	
15 x 8	PIPSTE267		PIPSTE268		PIPSTE269		PIPSTE269-1	
15 x 10	PIPSTE271		PIPSTE272		PIPSTE273		PIPSTE273-1	
15 x 12	PIPSTE275		PIPSTE276		PIPSTE277		PIPSTE277-1	
15 x 15	PIPSTE279		PIPSTE280		PIPSTE281		PIPSTE281-1	



INTRO | 1. ELECTRICAL | 2. PUMP Acc. | 3. HOSE, PE PIPE & Acc. | 4. IPS, PIP PIPE & Acc. | 5. SURFACE | 6. SPRINKLERS | 7. TRAVELER & WHEEL MOVE | 8. PIVOT | 9. TURN | 10. LOW VOLUME | 11. FILTERS | 12. INJECTION | 13. HARDWARE | INDEX

PIP WYE SADDLE

Size - Inches	Part No.	Price
6 x 4	PIPSWS005	
8 x 4	PIPSWS055	
8 x 6	PIPSWS056	
10 x 4	PIPSWS105	
10 x 6	PIPSWS107	
10 x 8	PIPSWS109	
12 x 4	PIPSWS155	
12 x 6	PIPSWS157	
12 x 8	PIPSWS159	
12 x 10	PIPSWS161	
15 x 4	PIPSWS255	
15 x 6	PIPSWS257	
15 x 8	PIPSWS259	
15 x 10	PIPSWS261	
15 x 12	PIPSWS263	



Note: These are special order & NON-RETURNABLE.
For drain only - Not pressure rated.

PIP WYE

Size - Inches	Part No.	Price
6 x 4	PIPSWY001	
6 x 6	PIPSWY003	
8 x 4	PIPSWY051	
8 x 6	PIPSWY053	
8 x 8	PIPSWY054	
10 x 4	PIPSWY105	
10 x 6	PIPSWY107	
10 x 8	PIPSWY109	
10 x 10	PIPSWY111	
12 x 4	PIPSWY155	
12 x 6	PIPSWY157	
12 x 8	PIPSWY159	
12 x 10	PIPSWY161	
12 x 12	PIPSWY163	
15 x 4	PIPSWY255	
15 x 6	PIPSWY257	
15 x 8	PIPSWY259	
15 x 10	PIPSWY261	
15 x 12	PIPSWY263	
15 x 15	PIPSWY267	



Note: These are special order & NON-RETURNABLE.
For drain only - Not pressure rated.

PIP UV RESISTANT FITTINGS

Size - Inches	Part No.	Description	Price
6	PIPUCO003	100 PSI Coupler	
8	PIPUCO053	100 PSI Coupler	
10	PIPUCO102	80 PSI Coupler	
6	PIPUEL003	11° 100 PSI EII	
6	PIPUEL007	15° 100 PSI EII	
6	PIPUEL019	45° 100 PSI EII	
6	PIPUEL020	90° 100 PSI EII	
8	PIPUEL068	45° 100 PSI EII	
8	PIPUEL072	90° 100 PSI EII	
10	PIPUEL117	45° 80 PSI EII	
10	PIPUEL118	90° 80 PSI EII	
6 x 4	PIPURE011	100 PSI Reducer	
8 x 6	PIPURE065	100 PSI Reducer	
10 x 8	PIPURE119	100 PSI Reducer	
6 x 2	PIPUTE003	100 PSI Tee	
6 x 4	PIPUTE011	100 PSI Tee	
6 x 6	PIPUTE001	100 PSI Tee	
8 x 8	PIPUTE060	100 PSI Tee	

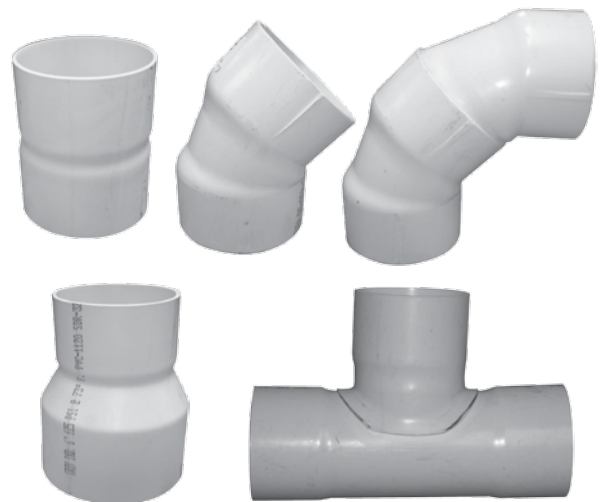

PVC PIP FABRICATED GASKETED FITTINGS

PIP X IPS ADAPTER - G X G

Size Inches	125 PSI	
	Part No.	Price
6	PIPGAD002-2	
8	PIPGAD052-2	
10	PIPGAD102-2	
12	PIPGAD152-2	



PIP COUPLER WITH CENTER STOP - G X G

Size Inches	80 PSI		100 PSI		125 PSI	
	Part No.	Price	Part No.	Price	Part No.	Price
6	-		PIPGCO003-2		PIPGCO003-2-1	
8	-		PIPGCO053-2		PIPGCO053-2-1	
10	PIPGCO102-2		PIPGCO103-2		PIPGCO103-2-1	
12	PIPGCO152-2		PIPGCO153-2		PIPGCO153-2-1	
15	PIPGCO252-2		PIPGCO253-2		PIPGCO253-2-1	



PIP CROSS - G X G X G X G

Size Inches	80 PSI		100 PSI		125 PSI	
	Part No.	Price	Part No.	Price	Part No.	Price
6	PIPGCR014-4		PIPGCR015-4		PIPGCR015-4-1	
8	PIPGCR068-4		PIPGCR069-4		PIPGCR069-4-1	
10	PIPGCR122-4		PIPGCR123-4		PIPGCR123-4-1	
12	PIPGCR176-4		PIPGCR177-4		PIPGCR177-4-1	
15	PIPGCR288-4		PIPGCR289-4		PIPGCR289-4-1	



Additional Crosses & Reducing Crosses in both Gasket x Gasket & Gasket x Socket or Spigot are available for quote based upon your needs.

PIP ELBOW - G X S

Size In. x Deg.	80 PSI		100 PSI		125 PSI	
	Part No.	Price	Part No.	Price	Part No.	Price
6 x 11°	-		PIPGEL003-1		PIPGEL003-1-1	
6 x 22°	-		PIPGEL011-1		PIPGEL011-1-1	
6 x 30°	-		PIPGEL015-1		PIPGEL015-1-1	
6 x 45°	-		PIPGEL019-1		PIPGEL019-1-1	
6 x 90°	-		PIPGEL027-1		PIPGEL027-1-1	
8 x 11°	-		PIPGEL053-1		PIPGEL053-1-1	
8 x 22°	-		PIPGEL061-1		PIPGEL061-1-1	
8 x 30°	-		PIPGEL065-1		PIPGEL065-1-1	
8 x 45°	-		PIPGEL069-1		PIPGEL069-1-1	
8 x 90°	-		PIPGEL077-1		PIPGEL077-1-1	
10 x 11°	PIPGEL102-1		PIPGEL103-1		PIPGEL103-1-1	
10 x 22°	PIPGEL110-1		PIPGEL111-1		PIPGEL111-1-1	
10 x 30°	PIPGEL114-1		PIPGEL115-1		PIPGEL115-1-1	
10 x 45°	PIPGEL118-1		PIPGEL119-1		PIPGEL119-1-1	
10 x 90°	PIPGEL125-1		PIPGEL127-1		PIPGEL127-1-1	
12 x 11°	PIPGEL152-1		PIPGEL153-1		PIPGEL153-1-1	
12 x 22°	PIPGEL160-1		PIPGEL161-1		PIPGEL161-1-1	
12 x 30°	PIPGEL164-1		PIPGEL165-1		PIPGEL165-1-1	
12 x 45°	PIPGEL168-1		PIPGEL169-1		PIPGEL169-1-1	
12 x 90°	PIPGEL176-1		PIPGEL177-1		PIPGEL177-1-1	
15 x 11°	PIPGEL252-1		PIPGEL253-1		PIPGEL253-1-1	
15 x 22°	PIPGEL260-1		PIPGEL261-1		PIPGEL261-1-1	
15 x 30°	PIPGEL264-1		PIPGEL265-1		PIPGEL265-1-1	
15 x 45°	PIPGEL268-1		PIPGEL269-1		PIPGEL269-1-1	
15 x 90°	PIPGEL276-1		PIPGEL277-1		PIPGEL277-1-1	



INTRO
1. ELECTRICAL
2. PUMP ACC.
3. HOSE, PE PIPE & ACC.
4. IPS, PIP PIPE & ACC.
5. SURFACE
6. SPRINKLERS
7. TRAVELER & WHEEL MOVE
8. PIVOT
9. TURN
10. LOW VOLUME
11. FILTERS
12. INJECTION
13. HARDWARE
INDEX

PVC PIP FABRICATED GASKETED FITTINGS

PIP ELBOW - G X G

Size In. x Deg.	80 PSI		100 PSI		125 PSI	
	Part No.	Price	Part No.	Price	Part No.	Price
6 x 11°	-		PIPGEL003-2		PIPGEL003-2-1	
6 x 22°	-		PIPGEL011-2		PIPGEL011-2-1	
6 x 30°	-		PIPGEL015-2		PIPGEL015-2-1	
6 x 45°	-		PIPGEL019-2		PIPGEL019-2-1	
6 x 90°	-		PIPGEL027-2		PIPGEL027-2-1	
8 x 11°	-		PIPGEL053-2		PIPGEL053-2-1	
8 x 22°	-		PIPGEL061-2		PIPGEL061-2-1	
8 x 30°	-		PIPGEL065-2		PIPGEL065-2-1	
8 x 45°	-		PIPGEL069-2		PIPGEL069-2-1	
8 x 90°	-		PIPGEL077-2		PIPGEL077-2-1	
10 x 11°	PIPGEL102-2		PIPGEL103-2		PIPGEL103-2-1	
10 x 22°	PIPGEL110-2		PIPGEL111-2		PIPGEL111-2-1	
10 x 30°	PIPGEL114-2		PIPGEL115-2		PIPGEL115-2-1	
10 x 45°	PIPGEL118-2		PIPGEL119-2		PIPGEL119-2-1	
10 x 90°	PIPGEL125-2		PIPGEL127-2		PIPGEL127-2-1	
12 x 11°	PIPGEL152-2		PIPGEL153-2		PIPGEL153-2-1	
12 x 22°	PIPGEL160-2		PIPGEL161-2		PIPGEL161-2-1	
12 x 30°	PIPGEL164-2		PIPGEL165-2		PIPGEL165-2-1	
12 x 45°	PIPGEL168-2		PIPGEL169-2		PIPGEL169-2-1	
12 x 90°	PIPGEL176-2		PIPGEL177-2		PIPGEL177-2-1	
15 x 11°	PIPGEL252-2		PIPGEL253-2		PIPGEL253-2-1	
15 x 22°	PIPGEL260-2		PIPGEL261-2		PIPGEL261-2-1	
15 x 30°	PIPGEL264-2		PIPGEL265-2		PIPGEL265-2-1	
15 x 45°	PIPGEL268-2		PIPGEL269-2		PIPGEL269-2-1	
15 x 90°	PIPGEL276-2		PIPGEL277-2		PIPGEL277-2-1	



PIP REPAIR COUPLER WITHOUT CENTER STOP - G X G

Size Inches	100 PSI		125 PSI	
	Part No.	Price	Part No.	Price
6	PIPGRC001		PIPGRC001-1	
8	PIPGRC051		PIPGRC051-1	
10	PIPGRC101		PIPGRC101-1	
12	PIPGRC151		PIPGRC151-1	
15	PIPGRC251		PIPGRC251-1	



PIP REDUCER G X S

Size Inches	100 PSI		125 PSI	
	Part No.	Price	Part No.	Price
6 x 2	PIPGRE003-1		PIPGRE003-1-1	
6 x 3	PIPGRE007-1		PIPGRE007-1-1	
6 x 4	PIPGRE011-1		PIPGRE011-1-1	
8 x 2	PIPGRE053-1		PIPGRE053-1-1	
8 x 3	PIPGRE057-1		PIPGRE057-1-1	
8 x 4	PIPGRE061-1		PIPGRE061-1-1	
8 x 6	PIPGRE065-1		PIPGRE065-1-1	
10 x 2	PIPGRE103-1		PIPGRE103-1-1	
10 x 3	PIPGRE107-1		PIPGRE107-1-1	
10 x 4	PIPGRE111-1		PIPGRE111-1-1	
10 x 6	PIPGRE115-1		PIPGRE115-1-1	
10 x 8	PIPGRE119-1		PIPGRE119-1-1	
12 x 2	PIPGRE153-1		PIPGRE153-1-1	
12 x 3	PIPGRE157-1		PIPGRE157-1-1	
12 x 4	PIPGRE161-1		PIPGRE161-1-1	
12 x 6	PIPGRE165-1		PIPGRE165-1-1	
12 x 8	PIPGRE169-1		PIPGRE169-1-1	
12 x 10	PIPGRE173-1		PIPGRE173-1-1	
15 x 2	PIPGRE253-1		PIPGRE253-1-1	
15 x 4	PIPGRE261-1		PIPGRE261-1-1	
15 x 6	PIPGRE265-1		PIPGRE265-1-1	
15 x 8	PIPGRE269-1		PIPGRE269-1-1	
15 x 10	PIPGRE273-1		PIPGRE273-1-1	
15 x 12	PIPGRE277-1		PIPGRE277-1-1	



PVC PIP FABRICATED GASKETED FITTINGS

PIP REDUCER - G X G

Size Inches	100 PSI		125 PSI	
	Part No.	Price	Part No.	Price
8 x 6	PIPGRE065-2		PIPGRE065-2-1	
10 x 6	PIPGRE115-2		PIPGRE115-2-1	
10 x 8	PIPGRE119-2		PIPGRE119-2-1	
12 x 6	PIPGRE165-2		PIPGRE165-2-1	
12 x 8	PIPGRE169-2		PIPGRE169-2-1	
12 x 10	PIPGRE173-2		PIPGRE173-2-1	
15 x 6	PIPGRE265-2		PIPGRE265-2-1	
15 x 8	PIPGRE269-2		PIPGRE269-2-1	
15 x 10	PIPGRE273-2		PIPGRE273-2-1	
15 x 12	PIPGRE277-2		PIPGRE277-2-1	



PIP TEE - G X G X S OR M X G X G

Please specify end configuration upon placement of order.

Size Inches	80 PSI		100 PSI		125 PSI	
	Part No.	Price	Part No.	Price	Part No.	Price
6 x 3	-		PIPGTE009-2		PIPGTE009-2-1	
6 x 4	-		PIPGTE011-2		PIPGTE011-2-1	
6 x 6	-		PIPGTE015-2		PIPGTE015-2-1	
8 x 4	-		PIPGTE061-2		PIPGTE061-2-1	
8 x 6	-		PIPGTE065-2		PIPGTE065-2-1	
8 x 8	-		PIPGTE069-2		PIPGTE069-2-1	
10 x 6	PIPGTE114-2		PIPGTE115-2		PIPGTE115-2-1	
10 x 8	PIPGTE117-2		PIPGTE119-2		PIPGTE119-2-1	
10 x 10	PIPGTE122-2		PIPGTE123-2		PIPGTE123-2-1	
12 x 6	PIPGTE164-2		PIPGTE165-2		PIPGTE165-2-1	
12 x 8	PIPGTE168-2		PIPGTE169-2		PIPGTE169-2-1	
12 x 10	PIPGTE172-2		PIPGTE173-2		PIPGTE173-2-1	
12 x 12	PIPGTE176-2		PIPGTE177-2		PIPGTE177-2-1	
15 x 6	PIPGTE264-2		PIPGTE265-2		PIPGTE265-2-1	
15 x 8	PIPGTE268-2		PIPGTE269-2		PIPGTE269-2-1	
15 x 10	PIPGTE272-2		PIPGTE273-2		PIPGTE273-2-1	
15 x 12	PIPGTE276-2		PIPGTE277-2		PIPGTE277-2-1	
15 x 15	PIPGTE280-2		PIPGTE281-2		PIPGTE281-2-1	



PIP TEE - G X G X G

Size Inches	80 PSI		100 PSI		125 PSI	
	Part No.	Price	Part No.	Price	Part No.	Price
6 x 4	-		PIPGTE011-3		PIPGTE011-3-1	
6 x 6	-		PIPGTE015-3		PIPGTE015-3-1	
8 x 4	-		PIPGTE061-3		PIPGTE061-3-1	
8 x 6	-		PIPGTE065-3		PIPGTE065-3-1	
8 x 8	-		PIPGTE069-3		PIPGTE069-3-1	
10 x 6	PIPGTE114-3		PIPGTE115-3		PIPGTE115-3-1	
10 x 8	PIPGTE117-3		PIPGTE119-3		PIPGTE119-3-1	
10 x 10	PIPGTE122-3		PIPGTE123-3		PIPGTE123-3-1	
12 x 6	PIPGTE164-3		PIPGTE165-3		PIPGTE165-3-1	
12 x 8	PIPGTE168-3		PIPGTE169-3		PIPGTE169-3-1	
12 x 10	PIPGTE172-3		PIPGTE173-3		PIPGTE173-3-1	
12 x 12	PIPGTE176-3		PIPGTE177-3		PIPGTE177-3-1	
15 x 6	PIPGTE264-3		PIPGTE265-3		PIPGTE265-3-1	
15 x 8	PIPGTE268-3		PIPGTE269-3		PIPGTE269-3-1	
15 x 10	PIPGTE272-3		PIPGTE273-3		PIPGTE273-3-1	
15 x 12	PIPGTE276-3		PIPGTE277-3		PIPGTE277-3-1	
15 x 15	PIPGTE280-3		PIPGTE281-3		PIPGTE281-3-1	



INTRO
 1. ELECTRICAL
 2. PUMP ACC.
 3. HOSE, PE PIPE & ACC.
 4. IPS, PIP PIPE & ACC.
 5. SURFACE
 6. SPRINKLERS
 7. TRAVELER & WHEEL MOVE
 8. PIVOT
 9. TURF
 10. LOW VOLUME
 11. FILTERS
 12. INJECTION
 13. HARDWARE
 INDEX

PVC IPS FABRICATED SOLVENT WELD FITTINGS

IPS AIR RELIEF VALVE ADAPTER

Size Inches	125 PSI		160 PSI	
	Part No.	Price	Part No.	Price
6 x 2	IPSSAR003		IPSSAR004	
8 x 3	IPSSAR053		IPSSAR054	
10 x 3	IPSSAR103		IPSSAR104	
12 x 4	IPSSAR153		IPSSAR154	



IPS CAP

Size Inches	125 PSI		160 PSI	
	Part No.	Price	Part No.	Price
6	IPSSCA003		IPSSCA004	
8	IPSSCA053		IPSSCA054	
10	IPSSCA103		IPSSCA104	
12	IPSSCA153		IPSSCA154	



IPS COUPLING

Size Inches	100 PSI		125 PSI		160 PSI	
	Part No.	Price	Part No.	Price	Part No.	Price
6	IPSSCO002		IPSSCO003		IPSSCO004	
8	IPSSCO052		IPSSCO053		IPSSCO054	
10	IPSSCO102		IPSSCO103		IPSSCO104	
12	IPSSCO152		IPSSCO153		IPSSCO154	



IPS CROSS

Size Inches	100 PSI		125 PSI		160 PSI	
	Part No.	Price	Part No.	Price	Part No.	Price
6 x 2	IPSSCR001		IPSSCR002		IPSSCR003	
6 x 3	IPSSCR005		IPSSCR006		IPSSCR007	
6 x 4	IPSSCR009		IPSSCR010		IPSSCR011	
6 x 6	IPSSCR013		IPSSCR014		IPSSCR015	
8 x 2	IPSSCR052		IPSSCR053		IPSSCR054	
8 x 3	IPSSCR056		IPSSCR057		IPSSCR058	
8 x 4	IPSSCR060		IPSSCR061		IPSSCR062	
8 x 6	IPSSCR064		IPSSCR065		IPSSCR066	
8 x 8	IPSSCR068		IPSSCR069		IPSSCR070	
10 x 2	IPSSCR102		IPSSCR103		IPSSCR104	
10 x 3	IPSSCR105		IPSSCR106		IPSSCR107	
10 x 4	IPSSCR110		IPSSCR111		IPSSCR112	
10 x 6	IPSSCR114		IPSSCR115		IPSSCR116	
10 x 8	IPSSCR118		IPSSCR119		IPSSCR120	
10 x 10	IPSSCR122		IPSSCR123		IPSSCR124	
12 x 2	IPSSCR152		IPSSCR153		IPSSCR154	
12 x 3	IPSSCR156		IPSSCR157		IPSSCR158	
12 x 4	IPSSCR160		IPSSCR161		IPSSCR162	
12 x 6	IPSSCR164		IPSSCR165		IPSSCR166	
12 x 8	IPSSCR168		IPSSCR169		IPSSCR170	
12 x 10	IPSSCR172		IPSSCR173		IPSSCR174	
12 x 12	IPSSCR176		IPSSCR177		IPSSCR178	



IPS ELBOW

Size In. x Deg.	100 PSI		125 PSI		160 PSI	
	Part No.	Price	Part No.	Price	Part No.	Price
6 x 11°	IPSSEL002		IPSSEL003		IPSSEL004	
6 x 22°	IPSSEL006		IPSSEL007		IPSSEL008	
6 x 30°	IPSSEL009		IPSSEL010		IPSSEL011	
6 x 45°	IPSSEL014		IPSSEL015		IPSSEL016	
6 x 90°	IPSSEL022		IPSSEL023		IPSSEL024	



CONTINUED NEXT PAGE

IPS ELBOW - CONTINUED

Size In. x Deg.	100 PSI		125 PSI		160 PSI	
	Part No.	Price	Part No.	Price	Part No.	Price
8 x 11°	IPSSSEL052		IPSSSEL053		IPSSSEL054	
8 x 22°	IPSSSEL056		IPSSSEL057		IPSSSEL058	
8 x 30°	IPSSSEL060		IPSSSEL061		IPSSSEL062	
8 x 45°	IPSSSEL064		IPSSSEL065		IPSSSEL066	
8 x 90°	IPSSSEL072		IPSSSEL073		IPSSSEL074	
10 x 11°	IPSSSEL102		IPSSSEL103		IPSSSEL104	
10 x 22°	IPSSSEL106		IPSSSEL107		IPSSSEL108	
10 x 30°	IPSSSEL109		IPSSSEL110		IPSSSEL111	
10 x 45°	IPSSSEL112		IPSSSEL114		IPSSSEL115	
10 x 90°	IPSSSEL116		IPSSSEL122		IPSSSEL123	
12 x 11°	IPSSSEL153		IPSSSEL154		IPSSSEL155	
12 x 22°	IPSSSEL158		IPSSSEL160		IPSSSEL161	
12 x 30°	IPSSSEL162		IPSSSEL164		IPSSSEL165	
12 x 45°	IPSSSEL166		IPSSSEL172		IPSSSEL173	
12 x 90°	IPSSSEL174		IPSSSEL175		IPSSSEL176	



IPS FEMALE ADAPTER

Size Inches	125 PSI	
	Part No.	Price
10	IPSSFA010	
12	IPSSFA012	



IPS VAN STONE FLANGE

Size Inches	125 PSI	
	Part No.	Price
6	854-060	
8	854-080	
10	854-100	
12	854-120	



IPS MALE ADAPTER

Size Inches	125 PSI	
	Part No.	Price
10	IPSSMA010	
12	IPSSMA012	

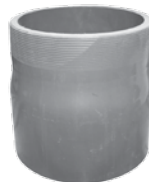

IPS REDUCING COUPLING

Size Inches	125 PSI		160 PSI	
	Part No.	Price	Part No.	Price
6 x 2	IPSSRE003		IPSSRE004	
6 x 3	IPSSRE007		IPSSRE008	
6 x 4	IPSSRE011		IPSSRE012	
8 x 2	IPSSRE053		IPSSRE054	
8 x 3	IPSSRE057		IPSSRE058	
8 x 4	IPSSRE061		IPSSRE062	
8 x 6	IPSSRE065		IPSSRE066	
10 x 2	IPSSRE103		IPSSRE104	
10 x 3	IPSSRE107		IPSSRE108	
10 x 4	IPSSRE111		IPSSRE112	
10 x 6	IPSSRE115		IPSSRE116	
10 x 8	IPSSRE119		IPSSRE120	
12 x 2	IPSSRE153		IPSSRE154	
12 x 3	IPSSRE157		IPSSRE158	
12 x 4	IPSSRE161		IPSSRE162	
12 x 6	IPSSRE165		IPSSRE166	
12 x 8	IPSSRE169		IPSSRE170	
12 x 10	IPSSRE173		IPSSRE174	



INTRO
 1. ELECTRICAL
 2. PUMP ACC.
 3. HOSE, PE PIPE & ACC.
 4. IPS, PIP PIPE & ACC.
 5. SURFACE
 6. SPRINKLERS
 7. TRAVELER & WHEEL MOVE
 8. PIVOT
 9. TURF
 10. LOW VOLUME
 11. FILTERS
 12. INJECTION
 13. HARDWARE
 INDEX

IPS SADDLE TEE

Size Inches	100 PSI		160 PSI	
	Part No.	Price	Part No.	Price
6 x 2	IPSSA002		IPSSA004	
6 x 3	IPSSA006		IPSSA008	
6 x 4	IPSSA010		IPSSA012	
8 x 2	IPSSA052		IPSSA054	
8 x 3	IPSSA057		IPSSA059	
8 x 4	IPSSA061		IPSSA063	
8 x 6	IPSSA065		IPSSA067	
10 x 2	IPSSA102		IPSSA104	
10 x 3	IPSSA106		IPSSA108	
10 x 4	IPSSA110		IPSSA112	
10 x 6	IPSSA114		IPSSA116	
10 x 8	IPSSA118		IPSSA120	
12 x 2	IPSSA152		IPSSA154	
12 x 3	IPSSA156		IPSSA158	
12 x 4	IPSSA160		IPSSA162	
12 x 6	IPSSA164		IPSSA166	
12 x 8	IPSSA168		IPSSA170	
12 x 10	IPSSA172		IPSSA174	



Note: These are special order & NON-RETURNABLE.

IPS TEE

Size Inches	100 PSI		125 PSI		160 PSI	
	Part No.	Price	Part No.	Price	Part No.	Price
6 x 2	IPSSTE002		IPSSTE003		IPSSTE004	
6 x 3	IPSSTE005		IPSSTE006		IPSSTE007	
6 x 4	IPSSTE009		IPSSTE010		IPSSTE011	
6 x 6	IPSSTE013		IPSSTE014		IPSSTE015	
8 x 2	IPSSTE052		IPSSTE053		IPSSTE054	
8 x 3	IPSSTE056		IPSSTE057		IPSSTE058	
8 x 4	IPSSTE060		IPSSTE061		IPSSTE062	
8 x 6	IPSSTE064		IPSSTE065		IPSSTE066	
8 x 8	IPSSTE068		IPSSTE069		IPSSTE070	
10 x 2	IPSSTE102		IPSSTE103		IPSSTE104	
10 x 3	IPSSTE106		IPSSTE107		IPSSTE108	
10 x 4	IPSSTE110		IPSSTE111		IPSSTE112	
10 x 6	IPSSTE114		IPSSTE115		IPSSTE116	
10 x 8	IPSSTE118		IPSSTE119		IPSSTE120	
10 x 10	IPSSTE122		IPSSTE123		IPSSTE124	
12 x 2	IPSSTE152		IPSSTE153		IPSSTE154	
12 x 3	IPSSTE156		IPSSTE157		IPSSTE158	
12 x 4	IPSSTE160		IPSSTE161		IPSSTE162	
12 x 6	IPSSTE164		IPSSTE165		IPSSTE166	
12 x 8	IPSSTE168		IPSSTE169		IPSSTE170	
12 x 10	IPSSTE172		IPSSTE173		IPSSTE174	
12 x 12	IPSSTE176		IPSSTE177		IPSSTE178	



IPS WYE SADDLE

Size Inches	Not Pressure Rated	
	Part No.	Price
6 x 4	IPSSWS003	
8 x 4	IPSSWS053	
8 x 6	IPSSWS054	
10 x 4	IPSSWS103	
10 x 6	IPSSWS104	
10 x 8	IPSSWS105	
12 x 4	IPSSWS153	
12 x 6	IPSSWS154	
12 x 8	IPSSWS155	
12 x 10	IPSSWS156	



Note: These are special order & NON-RETURNABLE.

PVC IPS FABRICATED SOLVENT WELD FITTINGS

IPS WYE

Size Inches	Not Pressure Rated	
	Part No.	Price
6 x 4	IPSSWY003	
6 x 6	IPSSWY004	
8 x 4	IPSSWY053	
8 x 6	IPSSWY054	
8 x 8	IPSSWY055	
10 x 4	IPSSWY103	
10 x 6	IPSSWY104	
10 x 8	IPSSWY105	
10 x 10	IPSSWY106	
12 x 4	IPSSWY153	
12 x 6	IPSSWY154	
12 x 8	IPSSWY155	
12 x 10	IPSSWY156	
12 x 12	IPSSWY157	



Note: These are special order & NON-RETURNABLE.

IPS UV RESISTANT FITTINGS - 100 PSI

Size Inches	Part No.	Description	Price
6	IPSUCO002	Coupler	
8	IPSUCO052	Coupler	
6	IPSUEL014	45° Elbow	
6	IPSUEL022	90° Elbow	
8	IPSUEL064	45° Elbow	
8	IPSUEL072	90° Elbow	
6 x 4	IPSURE010	Reducer	
8 x 6	IPSURE065	Reducer	
6 x 2	IPSUTE002	Tee	
6 x 4	IPSUTE009	Tee	
6	IPSUTE013	Tee	
8 x 4	IPSUTE060	Tee	
8 x 6	IPSUTE064	Tee	
8	IPSUTE068	Tee	

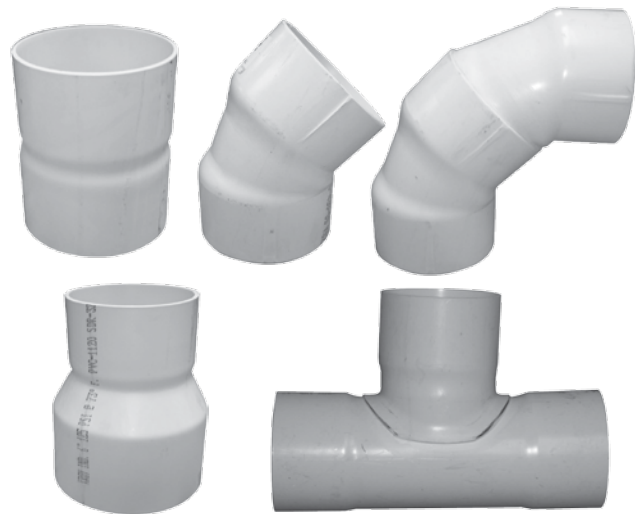

PVC IPS FABRICATED GASKETED FITTINGS

IPS COUPLER - G X G

Size Inches	100 PSI		125 PSI		160 PSI	
	Part No.	Price	Part No.	Price	Part No.	Price
6	IPSGCO001-2		IPSGCO002-2		IPSGCO003-2	
8	IPSGCO051-2		IPSGCO052-2		IPSGCO053-2	
10	IPSGCO101-2		IPSGCO102-2		IPSGCO103-2	
12	IPSGCO151-2		IPSGCO152-2		IPSGCO153-2	



IPS CROSS - G X G X G X G

Size Inches	100 PSI		125 PSI		160 PSI	
	Part No.	Price	Part No.	Price	Part No.	Price
6 x 6	IPSGCR013-4		IPSGCR014-4		IPSGCR015-4	
8 x 8	IPSGCR068-4		IPSGCR069-4		IPSGCR070-4	
10 x 10	IPSGCR122-4		IPSGCR123-4		IPSGCR124-4	
12 x 12	IPSGCR176-4		IPSGCR177-4		IPSGCR178-4	



Note: Crosses & Reducing Crosses are available in either Gasketed, Gasket x Spigot or Belled. Please contact us for your pricing on these items.

Note: These are special order & NON-RETURNABLE.

PVC IPS FABRICATED GASKETED FITTINGS

IPS ELBOW - G X S (SPECIFY SPIGOT OR SOCKET WHEN ORDERING)

Size In. x Deg.	100 PSI		125 PSI		160 PSI	
	Part No.	Price	Part No.	Price	Part No.	Price
6 x 11°	IPSGEL001-1		IPSGEL003-1		IPSGEL004-1	
6 x 22°	IPSGEL005-1		IPSGEL006-1		IPSGEL007-1	
6 x 30°	IPSGEL013-1		IPSGEL014-1		IPSGEL015-1	
6 x 45°	IPSGEL019-1		IPSGEL020-1		IPSGEL021-1	
6 x 90°	IPSGEL025-1		IPSGEL026-1		IPSGEL027-1	
8 x 11°	IPSGEL051-1		IPSGEL052-1		IPSGEL053-1	
8 x 22°	IPSGEL056-1		IPSGEL057-1		IPSGEL060-1	
8 x 30°	IPSGEL062-1		IPSGEL064-1		IPSGEL066-1	
8 x 45°	IPSGEL068-1		IPSGEL070-1		IPSGEL072-1	
8 x 90°	IPSGEL075-1		IPSGEL076-1		IPSGEL078-1	
10 x 11°	IPSGEL101-1		IPSGEL102-1		IPSGEL104-1	
10 x 22°	IPSGEL106-1		IPSGEL108-1		IPSGEL110-1	
10 x 30°	IPSGEL112-1		IPSGEL114-1		IPSGEL116-1	
10 x 45°	IPSGEL118-1		IPSGEL120-1		IPSGEL122-1	
10 x 90°	IPSGEL124-1		IPSGEL126-1		IPSGEL128-1	
12 x 11°	IPSGEL151-1		IPSGEL152-1		IPSGEL154-1	
12 x 22°	IPSGEL156-1		IPSGEL158-1		IPSGEL160-1	
12 x 30°	IPSGEL162-1		IPSGEL164-1		IPSGEL166-1	
12 x 45°	IPSGEL168-1		IPSGEL170-1		IPSGEL172-1	
12 x 90°	IPSGEL174-1		IPSGEL176-1		IPSGEL178-1	



IPS ELBOW - G X G

Size In. x Deg.	100 PSI		125 PSI		160 PSI	
	Part No.	Price	Part No.	Price	Part No.	Price
6 x 11°	IPSGEL002-2		IPSGEL003-2		IPSGEL004-2	
6 x 22°	IPSGEL005-2		IPSGEL006-2		IPSGEL007-2	
6 x 30°	IPSGEL013-2		IPSGEL014-2		IPSGEL015-2	
6 x 45°	IPSGEL019-2		IPSGEL020-2		IPSGEL021-2	
6 x 90°	IPSGEL025-2		IPSGEL026-2		IPSGEL027-2	
8 x 11°	IPSGEL051-2		IPSGEL052-2		IPSGEL053-2	
8 x 22°	IPSGEL056-2		IPSGEL057-2		IPSGEL060-2	
8 x 30°	IPSGEL062-2		IPSGEL064-2		IPSGEL066-2	
8 x 45°	IPSGEL068-2		IPSGEL070-2		IPSGEL072-2	
8 x 90°	IPSGEL075-2		IPSGEL076-2		IPSGEL078-2	
10 x 11°	IPSGEL101-2		IPSGEL102-2		IPSGEL104-2	
10 x 22°	IPSGEL106-2		IPSGEL108-2		IPSGEL110-2	
10 x 30°	IPSGEL112-2		IPSGEL114-2		IPSGEL116-2	
10 x 45°	IPSGEL118-2		IPSGEL120-2		IPSGEL122-2	
10 x 90°	IPSGEL124-2		IPSGEL126-2		IPSGEL128-2	
12 x 11°	IPSGEL151-2		IPSGEL152-2		IPSGEL154-2	
12 x 22°	IPSGEL156-2		IPSGEL158-2		IPSGEL160-2	
12 x 30°	IPSGEL162-2		IPSGEL164-2		IPSGEL166-2	
12 x 45°	IPSGEL168-2		IPSGEL170-2		IPSGEL172-2	
12 x 90°	IPSGEL174-2		IPSGEL176-2		IPSGEL178-2	



IPS REPAIR COUPLER WITHOUT CENTER STOP - G X G

Size	100 PSI		125 PSI	
	Part No.	Price	Part No.	Price
6	IPSGRC001		IPSGRC002	
8	IPSGRC051		IPSGRC052	
10	IPSGRC101		IPSGRC102	
12	IPSGRC151		IPSGRC152	



IPS TELESCOPING REPAIR COUPLER - G X G

Size Inches	100 PSI		125 PSI	
	Part No.	Price	Part No.	Price
6	IPSGTR001		IPSGTR002	
8	IPSGTR051		IPSGTR052	
10	IPSGTR101		IPSGTR102	
12	IPSGTR151		IPSGTR152	



IPS REDUCER - G X S

Size Inches	125 PSI		160 PSI	
	Part No.	Price	Part No.	Price
6 x 4	IPSGRE010-1		IPSGRE012-1	
8 x 4	IPSGRE060-1		IPSGRE062-1	
8 x 6	IPSGRE064-1		IPSGRE066-1	
10 x 4	IPSGRE106-1		IPSGRE114-1	
10 x 6	IPSGRE116-1		IPSGRE117-1	
10 x 8	IPSGRE118-1		IPSGRE119-1	
12 x 6	IPSGRE162-1		IPSGRE164-1	
12 x 8	IPSGRE166-1		IPSGRE170-1	
12 x 10	IPSGRE172-1		IPSGRE173-1	



IPS REDUCER - G X G

Size Inches	125 PSI		160 PSI	
	Part No.	Price	Part No.	Price
6 x 4	IPSGRE010-2		IPSGRE012-2	
8 x 4	IPSGRE060-2		IPSGRE062-2	
8 x 6	IPSGRE064-2		IPSGRE066-2	
10 x 4	IPSGRE106-2		IPSGRE114-2	
10 x 6	IPSGRE116-2		IPSGRE117-2	
10 x 8	IPSGRE118-2		IPSGRE119-2	
12 x 6	IPSGRE162-2		IPSGRE164-2	
12 x 8	IPSGRE166-2		IPSGRE170-2	
12 x 10	IPSGRE172-2		IPSGRE173-2	



IPS RISER TEE - G X G X FIPT

Size Inches	125 PSI		160 PSI	
	Part No.	Price	Part No.	Price
6 x 3	IPSGRT006-2		IPSGRT007-2	
6 x 4	IPSGRT010-2		IPSGRT011-2	
8 x 3	IPSGRT054-2		IPSGRT055-2	
8 x 4	IPSGRT057-2		IPSGRT058-2	



INTRO
1. ELECTRICAL
2. PUMP ACC.
3. HOSE, PE PIPE & ACC.
4. IPS PIP PIPE & ACC.
5. SURFACE
6. SPRINKLERS
7. TRAVELER & WHEEL MOVE
8. PIVOT
9. TURF
10. LOW VOLUME
11. FILTERS
12. INJECTION
13. HARDWARE
INDEX

PVC IPS FABRICATED GASKETED FITTINGS

IPS TEE - G X G X S OR M X G X G

Please specify end configuration upon placement of order.

Size Inches	100 PSI		125 PSI		160 PSI	
	Part No.	Price	Part No.	Price	Part No.	Price
6 x 2	IPSGTE002-2		IPSGTE003-2		IPSGTE004-2	
6 x 3	IPSGTE005-2		IPSGTE006-2		IPSGTE007-2	
6 x 4	IPSGTE008-2		IPSGTE009-2		IPSGTE010-2	
6 x 6	IPSGTE011-2		IPSGTE014-2		IPSGTE016-2	
8 x 2	IPSGTE050-2		IPSGTE051-2		IPSGTE052-2	
8 x 3	IPSGTE053-2		IPSGTE054-2		IPSGTE055-2	
8 x 4	IPSGTE056-2		IPSGTE057-2		IPSGTE058-2	
8 x 6	IPSGTE060-2		IPSGTE062-2		IPSGTE064-2	
8 x 8	IPSGTE066-2		IPSGTE068-2		IPSGTE070-2	
10 x 2	IPSGTE101-2		IPSGTE102-2		IPSGTE103-2	
10 x 3	-		-		IPSGTE105-2	
10 x 4	IPSGTE106-2		IPSGTE107-2		IPSGTE108-2	
10 x 6	IPSGTE110-2		IPSGTE112-2		IPSGTE114-2	
10 x 8	IPSGTE116-2		IPSGTE118-2		IPSGTE120-2	
10 x 10	IPSGTE122-2		IPSGTE124-2		IPSGTE126-2	
12 x 2	IPSGTE150-2		IPSGTE151-2		IPSGTE152-2	
12 x 3	IPSGTE153-2		IPSGTE154-2		IPSGTE155-2	
12 x 4	IPSGTE156-2		IPSGTE157-2		IPSGTE158-2	
12 x 6	IPSGTE160-2		IPSGTE162-2		IPSGTE164-2	
12 x 8	IPSGTE166-2		IPSGTE168-2		IPSGTE170-2	
12 x 10	IPSGTE172-2		IPSGTE174-2		IPSGTE176-2	
12 x 12	IPSGTE178-2		IPSGTE180-2		IPSGTE182-2	



IPS TEE - G X G X G

Size Inches	100 PSI		125 PSI		160 PSI	
	Part No.	Price	Part No.	Price	Part No.	Price
6 x 6	IPSGTE012-3		IPSGTE014-3		IPSGTE016-3	
8 x 6	IPSGTE060-3		IPSGTE062-3		IPSGTE064-3	
8 x 8	IPSGTE066-3		IPSGTE068-3		IPSGTE070-3	
10 x 6	IPSGTE110-3		IPSGTE112-3		IPSGTE114-3	
10 x 8	IPSGTE116-3		IPSGTE118-3		IPSGTE120-3	
10 x 10	IPSGTE122-3		IPSGTE124-3		IPSGTE126-3	
12 x 6	IPSGTE160-3		IPSGTE162-3		IPSGTE164-3	
12 x 8	IPSGTE166-3		IPSGTE168-3		IPSGTE170-3	
12 x 10	IPSGTE172-3		IPSGTE174-3		IPSGTE176-3	
12 x 12	IPSGTE178-3		IPSGTE180-3		IPSGTE182-3	



SCHEDULE 40 PVC FITTINGS

TEE (soc x soc x soc)



Part No.	Size-In.	Box	Price
401-003	3/8	50	
401-005	1/2	50	
401-007	3/4	50	
401-010	1	50	
401-012	1-1/4	25	
401-015	1-1/2	25	
401-020	2	25	
401-025	2-1/2	10	
401-030	3	10	
401-040	4	6	
401-050	5	5	
401-060	6	4	
401-080	8	2	
401-100	10	1	
401-120	12	1	

REDUCING TEE (soc x soc x soc)



Part No.	Size-In.	Box	Price
401-053	3/8 x 3/8 x 1/2	50	
401-074	1/2 x 1/2 x 3/4	50	
401-075	1/2 x 1/2 x 1	50	
401-094	3/4 x 1/2 x 1/2	50	
401-095	3/4 x 1/2 x 3/4	50	
401-101	3/4 x 3/4 x 1/2	50	
401-102	3/4 x 3/4 x 1	50	
401-122	1 x 1/2 x 1	50	
401-124	1 x 3/4 x 1/2	50	
401-125	1 x 3/4 x 3/4	50	
401-126	1 x 3/4 x 1	50	
401-130	1 x 1 x 1/2	50	
401-131	1 x 1 x 3/4	50	
401-132	1 x 1 x 1-1/4	25	
401-133	1 x 1 x 1-1/2	25	
401-134	1 x 1 x 2	25	
401-156	1-1/4 x 1 x 1/2	25	
401-157	1-1/4 x 1 x 3/4	25	
401-158	1-1/4 x 1 x 1	25	
401-166	1-1/4 x 1-1/4 x 1/2	25	
401-167	1-1/4 x 1-1/4 x 3/4	25	
401-168	1-1/4 x 1-1/4 x 1	25	
401-169	1-1/4 x 1-1/4 x 1-1/2	25	
401-170	1-1/4 x 1-1/4 x 2	25	
401-199	1-1/2 x 1-1/4 x 1/2	25	
401-201	1-1/2 x 1-1/4 x 3/4	25	
401-202	1-1/2 x 1-1/4 x 1	25	
401-209	1-1/2 x 1-1/2 x 1/2	25	
401-210	1-1/2 x 1-1/2 x 3/4	25	
401-211	1-1/2 x 1-1/2 x 1	25	
401-212	1-1/2 x 1-1/2 x 1-1/4	25	
401-213	1-1/2 x 1-1/2 x 2	25	
401-214	1-1/2 x 1-1/2 x 2-1/2	25	
401-238	2 x 1-1/2 x 3/4	10	
401-239	2 x 1-1/2 x 1	10	
401-241	2 x 1-1/2 x 1-1/2	10	
401-247	2 x 2 x 1/2	10	
401-248	2 x 2 x 3/4	10	
401-249	2 x 2 x 1	10	
401-250	2 x 2 x 1-1/4	10	
401-251	2 x 2 x 1-1/2	10	
401-253	2 x 2 x 3	10	
401-254	2 x 2 x 4	6	
401-287	2-1/2 x 2-1/2 x 1/2	10	
401-288	2-1/2 x 2-1/2 x 3/4	10	
401-289	2-1/2 x 2-1/2 x 1	10	
401-290	2-1/2 x 2-1/2 x 1-1/4	10	
401-291	2-1/2 x 2-1/2 x 1-1/2	10	
401-292	2-1/2 x 2-1/2 x 2	10	

REDUCING TEE - Continued (soc x soc x soc)



Part No.	Size-In.	Box	Price
401-293	2-1/2 x 2-1/2 x 3	10	
401-294	2-1/2 x 2-1/2 x 4	6	
401-333	3 x 3 x 1/2	10	
401-334	3 x 3 x 3/4	10	
401-335	3 x 3 x 1	10	
401-336	3 x 3 x 1-1/4	10	
401-337	3 x 3 x 1-1/2	10	
401-338	3 x 3 x 2	6	
401-339	3 x 3 x 2-1/2	6	
401-342	3 x 3 x 4	6	
401-344	3 x 3 x 6	4	
401-415	4 x 4 x 1/2	6	
401-416	4 x 4 x 3/4	6	
401-417	4 x 4 x 1	6	
401-418	4 x 4 x 1-1/4	10	
401-419	4 x 4 x 1-1/2	10	
401-420	4 x 4 x 2	10	
401-421	4 x 4 x 2-1/2	6	
401-422	4 x 4 x 3	6	
401-426	4 x 4 x 6	4	
401-428	4 x 4 x 8	2	
401-486	5 x 5 x 2	5	
401-487	5 x 5 x 2-1/2	4	
401-488	5 x 5 x 3	4	
401-490	5 x 5 x 4	3	
401-492	5 x 5 x 6	4	
401-494	5 x 5 x 8	1	
401-526	6 x 6 x 1-1/4	4	
401-527	6 x 6 x 1-1/2	5	
401-528	6 x 6 x 2	3	
401-529	6 x 6 x 2-1/2	5	
401-530	6 x 6 x 3	5	
401-532	6 x 6 x 4	2	
401-533	6 x 6 x 5	4	
401-535	6 x 6 x 8	1	
401-537	6 x 6 x 10	1	
401-578	8 x 8 x 2	2	
401-579	8 x 8 x 2-1/2	4	
401-580	8 x 8 x 3	4	
401-582	8 x 8 x 4	2	
401-583	8 x 8 x 5	2	
401-585	8 x 8 x 6	2	
401-589	8 x 8 x 10	1	
401-621	10 x 10 x 2	1	
401-623	10 x 10 x 3	1	
401-624	10 x 10 x 4	1	
401-625	10 x 10 x 5	1	
401-626	10 x 10 x 6	1	
401-628	10 x 10 x 8	1	
401-632	10 x 10 x 12	1	
401-664	12 x 12 x 4	1	
401-666	12 x 12 x 6	1	
401-668	12 x 12 x 8	1	
401-670	12 x 12 x 10	1	

TEE (soc x soc x fipt)



Part No.	Size-In.	Box	Price
402-003	3/8	50	
402-005	1/2	50	
402-007	3/4	50	
402-010	1	50	
402-012	1-1/4	25	
402-015	1-1/2	25	
402-020	2	10	
402-025	2-1/2	10	
402-030	3	10	
402-040	4	6	

REDUCING TEE (soc x soc x fipt)



Part No.	Size-In.	Box	Price
402-071	1/2 x 1/2 x 1/8	50	
402-072	1/2 x 1/2 x 1/4	50	
402-074	1/2 x 1/2 x 3/4	50	
402-094	3/4 x 1/2 x 1/2	50	
402-095	3/4 x 1/2 x 3/4	50	
402-101	3/4 x 3/4 1/2	50	
402-124	1 x 3/4 x 1/2	50	
402-125	1 x 3/4 x 3/4	50	
402-130	1 x 1 x 1/2	50	
402-131	1 x 1 x 3/4	50	
402-156	1-1/4 x 1 x 1/2	25	
402-157	1-1/4 x 1 x 3/4	25	
402-158	1-1/4 x 1 x 1	25	
402-166	1-1/4 x 1-1/4 x 1/2	25	
402-167	1-1/4 x 1-1/4 x 3/4	25	
402-168	1-1/4 x 1-1/4 x 1	25	
402-199	1-1/2 x 1-1/4 x 1/2	25	
402-201	1-1/2 x 1-1/4 x 3/4	25	
402-202	1-1/2 x 1-1/4 x 1	25	
402-209	1-1/2 x 1-1/2 x 1/2	25	
402-210	1-1/2 x 1-1/2 x 3/4	25	
402-211	1-1/2 x 1-1/2 x 1	25	
402-212	1-1/2 x 1-1/2 x 1-1/4	25	
402-238	2 x 1-1/2 x 3/4	10	
402-239	2 x 1-1/2 x 1	10	
402-247	2 x 2 x 1/2	10	
402-248	2 x 2 x 3/4	10	
402-249	2 x 2 x 1	10	
402-250	2 x 2 x 1-1/4	10	
402-251	2 x 2 x 1-1/2	10	
402-287	2-1/2 x 2-1/2 x 1/2	10	
402-288	2-1/2 x 2-1/2 x 3/4	10	
402-289	2-1/2 x 2-1/2 x 1	10	
402-290	2-1/2 x 2-1/2 x 1-1/4	10	
402-291	2-1/2 x 2-1/2 x 1-1/2	10	
402-292	2-1/2 x 2-1/2 x 2	10	
402-333	3 x 3 x 1/2	10	
402-334	3 x 3 x 3/4	10	
402-335	3 x 3 x 1	10	
402-336	3 x 3 x 1-1/4	10	
402-337	3 x 3 x 1-1/2	10	
402-338	3 x 3 x 2	6	
402-417	4 x 4 x 1	6	
402-419	4 x 4 x 1-1/2	10	
402-420	4 x 4 x 2	10	
402-422	4 x 4 x 3	6	
402-490	5 x 5 x 4	3	
402-525	6 x 6 x 1	1	
402-528	6 x 6 x 2	3	
402-530	6 x 6 x 3	5	
402-532	6 x 6 x 4	2	
402-578	8 x 8 x 2	3	
402-580	8 x 8 x 3	4	
402-582	8 x 8 x 4	2	
402-621F	10 x 2	1	
402-622F	10 x 2-1/2	1	
402-623F	10 x 3	1	
402-624F	10 x 4	1	
402-661F	12 x 2	1	
402-663F	12 x 3	1	
402-664F	12 x 4	1	

TEE (soc x soc x mipt)



Part No.	Size-In.	Box	Price
402B-010	1	50	

INTRO 1. ELECTRICAL 2. PUMP Acc. 3. HOSE, PE PIPE & Acc. 4. IPS, PIP Pipe & Acc. 5. SURFACE 6. SPRINKLERS 7. TRAVELER & WHEEL MOVE 8. PIVOT 9. TURF 10. LOW VOLUME 11. FILTERS 12. INJECTION 13. HARDWARE INDEX

SCHEDULE 40 PVC FITTINGS

MANIFOLD TEE (o-ring mipt x fipt x mipt)



Part No.	Size-In.	Box	Price
451A-010	1	50	

TEE (soc x fipt x soc)



Part No.	Size-In.	Box	Price
403-095	3/4 x 1/2 x 3/4	50	

THREADED TEE (fipt x fipt x fipt)



Part No.	Size-In.	Box	Price
405-005	1/2	50	
405-007	3/4	50	
405-010	1	50	
405-012	1-1/4	25	
405-015	1-1/2	25	
405-020	2	10	
405-025	2-1/2"	5	

STREET TEE (spig x soc x soc)



Part No.	Size-In.	Box	Price
444-005	1/2	25	
444-007	3/4	15	
444-010	1	15	
444-012	1-1/4	10	
444-015	1-1/2	10	
444-020	2	10	

MANIFOLD TEE (spig x soc x mipt)



Part No.	Size-In.	Box	Price
476-010	1	20	

MANIFOLD TEE (spig x soc x fipt)



Part No.	Size-In.	Box	Price
477-010	1	25	

90° ELBOW (soc x soc)



Part No.	Size-In.	Box	Price
406-003	3/8	50	
406-005	1/2	50	
406-007	3/4	50	
406-010	1	50	
406-012	1-1/4	25	
406-015	1-1/2	25	
406-020	2	25	
406-025	2-1/2	10	
406-030	3	10	
406-040	4	8	
406-050	5	4	
406-060	6	4	
406-080	8	2	
406-100	10	1	
406-120	12	1	

90° REDUCING ELBOW (soc x soc)



Part No.	Size-In.	Box	Price
406-053	3/8 x 1/2	50	
406-101	3/4 x 1/2	50	
406-130	1 x 1/2	50	
406-131	1 x 3/4	50	
406-166	1-1/4 x 1/2	25	
406-167	1-1/4 x 3/4	25	
406-168	1-1/4 x 1	25	
406-209	1-1/2 x 1/2	25	
406-211	1-1/2 x 1	25	
406-212	1-1/2 x 1-1/4	25	
406-249	2 x 1	10	
406-250	2 x 1-1/4	10	
406-251	2 x 1-1/2	10	
406-292N	2-1/2 x 2	10	

90° SWEEP ELBOW (soc x soc)



Part No.	Size-In.	Box	Price
406-005S	1/2	25	
406-007S	3/4	25	
406-010S	1	25	
406-012S	1-1/4	25	
406-015S	1-1/2	25	
406-020S	2	25	

90° LONG SWEEP ELBOW (soc x soc)



Part No.	Size-In.	Box	Price
406-025LSF	2-1/2	1	
406-030LSF	3	1	
406-040LSF	4	1	
406-060LSF	6	1	
406-080LSF	8	1	

90° ELBOW (soc x fipt)



Part No.	Size-In.	Box	Price
407-005	1/2	50	
407-007	3/4	50	
407-010	1	50	
407-012	1-1/4	25	
407-015	1-1/2	25	
407-020	2	10	
407-025	2-1/2	10	
407-030	3	8	
407-040	4	4	

90° REDUCING ELBOW (soc x fipt)



Part No.	Size-In.	Box	Price
407-053	3/8 x 1/2	50	
407-074	1/2 x 3/4	50	
407-101	3/4 x 1/2	50	
407-130	1 x 1/2	50	
407-131	1 x 3/4	50	
407-168	1-1/4 x 1	25	
407-211	1-1/2 x 1	25	
407-212	1-1/2 x 1-1/4	20	
407-249	2 x 1	10	
407-250	2 x 1-1/4	10	
407-251	2 x 1-1/2	10	

90° THREADED ELBOW (fipt x fipt)



Part No.	Size-In.	Box	Price
408-005	1/2	50	
408-007	3/4	50	
408-010	1	50	
408-012	1-1/4	25	
408-015	1-1/2	25	
408-020	2	10	

90° STREET ELBOW (spig x soc)



Part No.	Size-In.	Box	Price
409-005	1/2	50	
409-007	3/4	50	
409-010	1	50	
409-012	1-1/4	25	
409-015	1-1/2	25	
409-020	2	10	
409-025	2-1/2	10	
409-030	3	5	
409-040	4	6	
409-050	5	2	
409-060	6	2	
409-080	8	2	
409-100	10	1	
409-120	12	1	

90° STREET ELBOW (mipt x soc)



Part No.	Size-In.	Box	Price
410-005	1/2	50	
410-007	3/4	50	
410-010	1	50	
410-012	1-1/4	25	
410-015	1-1/2	25	
410-020	2	10	
410-030	3	10	
410-101	3/4 x 1/2	50	
410-102	3/4 x 1	50	

90° STREET ELBOW (mipt x fipt)



Part No.	Size-In.	Box	Price
412-005	1/2	50	
412-007	3/4	50	
412-010	1	50	
412-012	1-1/4	25	
412-015	1-1/2	25	
412-020	2	10	
412-030	3	8	

90° HDPE STREET ELBOW (mipt x fipt)



Part No.	Size-In.	Box	Price
M412-005	1/2	50	
M412-007	3/4	50	
M412-010	1	50	
M412-012	1-1/4	25	
M412-015	1-1/2	25	

SCHEDULE 40 PVC FITTINGS

SIDE OUTLET ELBOW (soc x soc x soc)



Part No.	Size-In.	Box	Price
413-005	1/2	50	
413-007	3/4	50	
413-010	1	25	
413-015	1-1/2	10	
413-020	2	10	

45° STREET ELBOW (spig x soc)



Part No.	Size-In.	Box	Price
427-005	1/2	50	
427-007	3/4	50	
427-010	1	50	
427-012	1-1/4	25	
427-015	1-1/2	25	
427-020	2	25	
427-025	2-1/2	10	
427-030	3	10	
427-040	4	5	
427-050	5	2	
427-060	6	4	
427-080	8	2	
427-100	10	1	
427-120	12	1	

15° ELBOW (soc x soc)



Part No.	Size-In.	Box	Price
418-005F	1/2	25	
418-007F	3/4	23	
418-010F	1	20	
418-012F	1-1/4	15	
418-015F	1-1/2	25	
418-020F	2	25	
418-025F	2-1/2	18	
418-030F	3	1	
418-040F	4	1	
418-050F	5	1	
418-060F	6	1	
418-080F	8	1	
418-100F	10	1	
418-120F	12	1	

SIDE OUTLET ELBOW (soc x soc x fipt)



Part No.	Size-In.	Box	Price
414-005	1/2	50	
414-007	3/4	50	
414-101	3/4 x 3/4 x 1/2	50	
414-130	1 x 1 x 1/2	50	

30° ELBOW (soc x soc)



Part No.	Size-In.	Box	Price
415-005F	1/2	25	
415-007F	3/4	25	
415-010F	1	25	
415-012F	1-1/4	15	
415-015F	1-1/2	5	
415-020F	2	1	
415-025F	2-1/2	25	
415-030F	3	1	
415-040F	4	1	
415-050F	5	1	
415-060F	6	1	
415-080F	8	1	
415-100F	10	1	
415-120F	12	1	

11-1/4° ELBOW (soc x soc)



Part No.	Size-In.	Box	Price
411-005F	1/2	52	
411-007F	3/4	52	
411-010F	1	52	
411-012F	1-1/4	26	
411-015	1-1/2	25	
411-020	2	10	
411-025F	2-1/2	25	
411-030	3	10	
411-040	4	4	
411-050F	5	1	
411-060F	6	1	
411-080F	8	1	
411-100F	10	1	
411-120F	12	1	

60° ELBOW (soc x soc)



Part No.	Size-In.	Box	Price
424-005F	1/2	7	
424-007F	3/4	6	
424-010F	1	3	
424-012F	1-1/4	16	
424-015F	1-1/2	16	
424-020F	2	1	
424-025F	2-1/2	10	
424-030F	3	8	
424-040F	4	1	
424-050F	5	1	
424-060F	6	1	
424-080F	8	1	
424-100F	10	1	
424-120F	12	1	

22-1/2° ELBOW (soc x soc)



Part No.	Size-In.	Box	Price
416-005	1/2	20	
416-007	3/4	20	
416-010	1	20	
416-012	1-1/4	20	
416-015	1-1/2	20	
416-020	2	20	
416-025F	2-1/2	25	
416-030	3	5	
416-040	4	4	
416-050F	5	1	
416-060	6	4	
416-080	8	4	

CROSS (soc x soc x soc x soc)



Part No.	Size-In.	Box	Price
420-005	1/2	50	
420-007	3/4	50	
420-010	1	50	
420-012	1-1/4	25	
420-015	1-1/2	25	
420-020	2	10	
420-025	2-1/2	10	
420-030	3	5	
420-040	4	4	
420-050F	5	1	
420-060F	6	1	
420-080F	8	1	
420-100F	10	1	
420-120F	12	1	

45° ELBOW (soc x soc)



Part No.	Size-In.	Box	Price
417-005	1/2	50	
417-007	3/4	50	
417-010	1	50	
417-012	1-1/4	25	
417-015	1-1/2	25	
417-020	2	25	
417-025	2-1/2	10	
417-030	3	10	
417-040	4	5	
417-050	5	5	
417-060	6	8	
417-080	8	3	
417-100	10	1	
417-120	12	1	

22-1/2° STREET ELBOW (spigot x soc)



Part No.	Size-In.	Box	Price
442-005	1/2	50	
442-007	3/4	50	
442-010	1	50	
442-012	1-1/4	20	
442-015	1-1/2	25	
442-020	2	20	
442-025F	2-1/2	1	
442-030	3	1	
442-040	4	1	
442-060F	6	1	
442-080F	8	1	
442-100F	10	1	
442-120F	12	1	

CROSS (soc x mipt)



Part No.	Size-In.	Box	Price
421A-010	1	50	

SCHEDULE 40 PVC FITTINGS

COUPLING (soc x soc)



Part No.	Size-In.	Box	Price
429-003	3/8	50	
429-005	1/2	50	
429-007	3/4	50	
429-010	1	50	
429-012	1-1/4	25	
429-015	1-1/2	25	
429-020	2	25	
429-025	2-1/2	12	
429-030	3	10	
429-040	4	6	
429-050	5	5	
429-060	6	5	
429-080	8	8	
429-100F	10	1	
429-120F	12	1	

THREADED COUPLING (fipt x fipt)



Part No.	Size-In.	Box	Price
430-005	1/2	50	
430-007	3/4	50	
430-010	1	50	
430-012	1-1/4	10	
430-101	3/4 x 1/2	50	

REDUCING FEMALE ADAPTER (soc x fipt)



Part No.	Size-In.	Box	Price
435-072	1/2 x 1/4	50	
435-073	1/2 x 3/8	50	
435-074	1/2 x 3/4	50	
435-101	3/4 x 1/2	50	
435-102	3/4 x 1	50	
435-130	1 x 1/2	50	
435-131	1 x 3/4	50	
435-133	1 x 1-1/2	25	
436-168	1-1/4 x 1	25	

IPS TO PIP ADAPTER (spig x soc)



Part No.	Size-In.	Box	Price
431-060	6	5	
431-080	8	10	
431-100F	10	1	
431-120F	12	1	

DEEP SOCKET COUPLING (soc x soc)



Part No.	Size-In.	Box	Price
479-005N	1/2	50	
479-007	3/4	50	
479-015	1-1/2	50	
479-020	2	60	
479-025	2-1/2	25	
479-030	3	15	
479-040	4	8	
479-050F	5	1	

RISER EXTENSION (fipt x mipt)



Part No.	Size-In.	Box	Price
434-005	1/2	50	
434-007	3/4	50	
434-010	1	50	

IP T ADAPTER (mipt x fipt)



Part No.	Size-In.	Box	Price
446-003	3/8	50	
446-012	1-1/4	25	
446-053	3/8 x 1/2	50	
446-074	1/2 x 3/4	50	

REDUCER COUPLING (soc x soc)



Part No.	Size-In.	Box	Price
429-101	3/4 x 1/2	50	
429-130	1 x 1/2	25	
429-131	1 x 3/4	50	
429-166	1-1/4 x 1/2	25	
429-167	1-1/4 x 3/4	8	
429-168	1-1/4 x 1	25	
429-209	1-1/2 x 1/2	8	
429-210	1-1/2 x 3/4	25	
429-211	1-1/2 x 1	25	
429-212	1-1/2 x 1-1/4	25	
429-247	2 x 1/2	10	
429-248	2 x 3/4	10	
429-249	2 x 1	25	
429-250	2 x 1-1/4	10	
429-251	2 x 1-1/2	10	
429-291	2-1/2 x 1-1/2	10	
429-292	2-1/2 x 2	10	
429-335	3 x 1	10	
429-337	3 x 1-1/2	8	
429-338	3 x 2	8	
429-339	3 x 2-1/2	8	
429-416	4 x 3/4	10	
429-417	4 x 1	8	
429-420	4 x 2	4	
429-421	4 x 2-1/2	6	
429-422	4 x 3	4	
429-532	6 x 4	4	
429-582	8 x 4	1	
429-585	8 x 6	2	
429-624	10 x 4	1	
429-626	10 x 6	1	
429-628	10 x 8	1	
429-666	12 x 6	1	
429-668	12 x 8	1	

SPIGOT FEMALE ADAPTER (spig x fipt)



Part No.	Size-In.	Box	Price
478-005	1/2	50	
478-007	3/4	25	
478-010	1	50	
478-012	1-1/4	25	
478-015	1-1/2	20	
478-020	2	20	
478-030	3	10	
478-040	4	5	

FEMALE ADAPTER (soc x fipt)



Part No.	Size-In.	Box	Price
435-003	3/8	50	
435-005	1/2	50	
435-007	3/4	50	
435-010	1	50	
435-012	1-1/4	25	
435-015	1-1/2	25	
435-020	2	10	
435-025	2-1/2	10	
435-030	3	10	
435-040	4	6	
435-050	5	5	
435-060	6	5	
435-080	8	2	
435-100F	10	1	
435-120F	12	1	

MALE ADAPTER (mipt x spig)



Part No.	Size-In.	Box	Price
461-005	1/2	50	
461-007	3/4	50	
461-010	1	50	
461-012	1-1/4	25	
461-015	1-1/2	25	
461-020	2	25	
461-131	1 x 3/4	50	

MALE ADAPTER (mipt x soc)



Part No.	Size-In.	Box	Price
436-003	3/8	50	
436-005	1/2	50	
436-007	3/4	50	
436-010	1	50	
436-012	1-1/4	25	
436-015	1-1/2	25	
436-020	2	25	
436-025	2-1/2	10	
436-030	3	10	
436-040	4	5	
436-050	5	5	
436-060	6	7	
436-080	8	3	
436-100F	10	1	
436-120F	12	1	

REDUCING MALE ADAPTER (mipt x soc)



Part No.	Size-In.	Box	Price
436-053	3/8 x 1/2	50	
436-073	1/2 x 3/8	50	
436-074	1/2 x 3/4	50	
436-075	1/2 x 1	50	
436-101	3/4 x 1/2	50	
436-102	3/4 x 1	50	
436-131	1 x 3/4	50	
436-132	1 x 1-1/4	50	
436-133	1 x 1-1/2	50	
436-168	1-1/4 x 1	25	
436-169	1-1/4 x 1-1/2	25	
436-212	1-1/2 x 1-1/4	25	
436-213	1-1/2 x 2	25	
436-251	2 x 1-1/2	10	
436-252	2 x 2-1/2	10	
436-253	2 x 3	10	
436-294	2-1/2 x 3	10	
436-296	2-1/2 x 4	10	
436-342	3 x 4	10	
436-537F	6 x 10	1	

SCHEDULE 40 PVC FITTINGS

REDUCER BUSHING (spig x soc)



Part No.	Size-In.	Box	Price
437-072	1/2 x 1/4	50	
437-073	1/2 x 3/8	50	
437-101	3/4 x 1/2	50	
437-130	1 x 1/2	50	
437-131	1 x 3/4	50	
437-166	1-1/4 x 1/2	25	
437-167	1-1/4 x 3/4	25	
437-168	1-1/4 x 1	25	
437-209	1-1/2 x 1/2	25	
437-210	1-1/2 x 3/4	25	
437-211	1-1/2 x 1	25	
437-212	1-1/2 x 1-1/4	25	
437-247	2 x 1/2	10	
437-248	2 x 3/4	10	
437-249	2 x 1	10	
437-250	2 x 1-1/4	10	
437-251	2 x 1-1/2	25	
437-287	2-1/2 x 1/2	10	
437-288	2-1/2 x 3/4	10	
437-289	2-1/2 x 1	10	
437-290	2-1/2 x 1-1/4	10	
437-291	2-1/2 x 1-1/2	10	
437-292	2-1/2 x 2	10	
437-333	3 x 1/2	10	
437-334	3 x 3/4	10	
437-335	3 x 1	10	
437-336	3 x 1-1/4	10	
437-337	3 x 1-1/2	10	
437-338	3 x 2	10	
437-339	3 x 2-1/2	10	
437-420	4 x 2	6	
437-421	4 x 2-1/2	6	
437-422	4 x 3	6	
437-486	5 x 2	5	
437-488	5 x 3	5	
437-490	5 x 4	5	
437-528	6 x 2	5	
437-530	6 x 3	5	
437-532	6 x 4	5	
437-534	6 x 5	5	
437-578	8 x 2	4	
437-580	8 x 3	4	
437-582	8 x 4	4	
437-583	8 x 5	4	
437-585	8 x 6	4	
437-623	10 x 3	2	
437-624	10 x 4	2	
437-626	10 x 6	2	
437-628	10 x 8	4	
437-664	12 x 4	2	
437-666	12 x 6	2	
437-668	12 x 8	2	
437-670	12 x 10	2	

REDUCER BUSHING (spig x fipt)



Part No.	Size-In.	Box	Price
438-071	1/2 x 1/8	50	
438-072	1/2 x 1/4	50	
438-073	1/2 x 3/8	50	
438-098	3/4 x 1/4	50	
438-101	3/4 x 1/2	50	
438-127	1 x 1/8	25	
438-128	1 x 1/4	50	
438-129	1 x 3/8	50	
438-130	1 x 1/2	50	
438-131	1 x 3/4	50	

REDUCER BUSHING - Continued (spig x fipt)



Part No.	Size-In.	Box	Price
438-166	1-1/4 x 1/2	25	
438-167	1-1/4 x 3/4	25	
438-168	1 1/4 x 1	25	
438-206	1-1/2 x 1/8	25	
438-207	1-1/2 x 1/4	25	
438-209	1-1/2 x 1/2	25	
438-210	1-1/2 x 3/4	25	
438-211	1-1/2 x 1	25	
438-212	1-1/2 x 1-1/4	25	
438-245	2 x 1/4	10	
438-247	2 x 1/2	10	
438-248	2 x 3/4	10	
438-249	2 x 1	10	
438-250	2 x 1-1/4	10	
438-251	2 x 1-1/2	10	
438-287	2-1/2 x 1/2	10	
438-288	2-1/2 x 3/4	10	
438-289	2-1/2 x 1	10	
438-290	2-1/2 x 1-1/4	10	
438-291	2-1/2 x 1-1/2	10	
438-292	2-1/2 x 2	10	
438-334	3 x 3/4	10	
438-335	3 x 1	10	
438-336	3 x 1-1/4	10	
438-337	3 x 1-1/2	10	
438-338	3 x 2	10	
438-339	3 x 2-1/2	10	
438-420	4 x 2	6	
438-421	4 x 2-1/2	6	
438-422	4 x 3	6	
438-488	5 x 3	5	
438-490	5 x 4	6	
438-528	6 x 2	5	
438-530	6 x 3	5	
438-532	6 x 4	5	
438-534	6 x 5	5	

THREADED BUSHING (mipt x fipt)



Part No.	Size-In.	Box	Price
439-052	3/8 x 1/4	50	
439-071	1/2 x 1/8	50	
439-072	1/2 x 1/4	50	
439-073	1/2 x 3/8	50	
439-098	3/4 x 1/4	50	
439-099	3/4 x 3/8	50	
439-101	3/4 x 1/2	50	
439-128	1 x 1/4	25	
439-130	1 x 1/2	50	
439-131	1 x 3/4	50	
439-166	1-1/4 x 1/2	25	
439-167	1-1/4 x 3/4	25	
439-168	1-1/4 x 1	25	
439-209	1-1/2 x 1/2	25	
439-210	1-1/2 x 3/4	25	
439-211	1-1/2 x 1	25	
439-212	1-1/2 x 1-1/4	25	
439-247	2 x 1/2	10	
439-248	2 x 3/4	10	
439-249	2 x 1	10	
439-250	2 x 1-1/4	10	
439-251	2 x 1-1/2	10	
439-292	2-1/2 x 2	10	
439-338	3 x 2	10	
439-339	3 x 2-1/2	10	
439-420	4 x 2	6	
439-422	4 x 3	6	

CAP (soc)



Part No.	Size-In.	Box	Price
447-003	3/8	50	
447-005	1/2	50	
447-007	3/4	50	
447-010	1	50	
447-012	1-1/4	25	
447-015	1-1/2	25	
447-020	2	10	
447-025	2-1/2	10	
447-030	3	10	
447-040	4	6	
447-050	5	5	
447-060	6	4	
447-080	8	3	
447-100F	10	1	
447-120F	12	1	

THREADED CAP (fipt)



Part No.	Size-In.	Box	Price
448-003	3/8	50	
448-005	1/2	50	
448-007	3/4	50	
448-010	1	50	
448-012	1 1/4	25	
448-015	1 1/2	25	
448-020	2	10	
448-025	2 1/2	10	
448-030	3	10	
448-040	4	6	
448-050	5	5	
448-060	6	8	

PLUG (spig)



Part No.	Size-In.	Box	Price
449-003	3/8	50	
449-005	1/2	50	
449-007	3/4	50	
449-010	1	50	
449-012	1-1/4	25	
449-015	1-1/2	25	
449-020	2	10	
449-025	2-1/2	10	
449-030	3	10	
449-040	4	6	
449-060F	6	1	
449-080F	8	1	
449-100F	10	1	
449-120F	12	1	

THREADED PLUG (mipt)



Part No.	Size-In.	Box	Price
450-003	3/8	50	
450-005	1/2	50	
450-007	3/4	50	
450-010	1	50	
450-012	1-1/4	25	
450-015	1-1/2	25	
450-020	2	10	
450-025	2-1/2	10	
450-030	3	10	
450-040	4	6	
450-060	6	6	
450-080F	8	1	
450-100F	10	1	
450-120F	12	1	

SCHEDULE 40 PVC FITTINGS

UNION (soc x soc)



Part No.	Size-In.	Box	Price
457-005	1/2	10	
457-007	3/4	10	
457-010	1	10	
457-012	1-1/4	5	
457-015	1-1/2	5	
457-020	2	5	
457-025	2-1/2	5	
457-030	3	5	
457-040	4	4	
457-060	6	1	

SNAP ON SADDLE (IPS O.D. x fipt)



Part No.	Size-In.	Box	Price
464-005	1/2	25	
464-007	3/4	25	
464-010	1	50	
464-071	1/2 x 1/8	50	
464-097	3/4 x 1/8	50	
464-101	3/4 x 1/2	25	
464-130	1 x 1/2	50	
464-131	1 x 3/4	50	
464-210	1-1/2 x 3/4	25	

EXPANSION COUPLING (spig x soc)



Part No.	Size-In.	Box	Price
QF-0500	1/2	30	
QF-0750	3/4	24	
QF-1000	1	18	
QF-1250	1-1/4	12	
QF-1500	1-1/2	12	
QF-2000	2	8	
QF-2500	2-1/2	4	
QF-3000	3	3	
QF-4000	4	2	

THREADED UNION (fipt x fipt)



Part No.	Size-In.	Box	Price
458-005	1/2	10	
458-007	3/4	10	
458-010	1	10	
458-012	1-1/4	5	
458-015	1-1/2	5	
458-020	2	5	
458-025	2-1/2	5	
458-030	3	5	
458-040	4	4	
458-060	6	1	

INSERT ADAPTER (insert x soc)



Part No.	Size-In.	Box	Price
474-005	1/2	50	
474-007	3/4	50	
474-010	1	50	
474-012	1-1/4	25	
474-015	1-1/2	25	
474-020	2	25	
474-030	3	15	
474-040	4	15	
474-060F	6	1	
474-080F	8	1	

COMPRESSION COUPLING (c x c)



Part No.	Size-In.	Box	Price
CPC-0500	1/2	30	
CPC-0750	3/4	24	
CPC-1000	1	18	
CPC-1250	1-1/4	12	
CPC-1500	1-1/2	15	
CPC-2000	2	12	
CPC-2500	2-1/2	5	
CPC-3000	3	4	
CPC-4000	4	3	
CPC-6000	6	1	

WYE (soc x soc x soc)



Part No.	Size-In.	Box	Price
475-005	1/2	25	
475-007	3/4	20	
475-010	1	20	
475-012	1-1/4	20	
475-015	1-1/2	20	
475-020	2	10	
475-025	2-1/2	4	
475-030	3	5	
475-040	4	4	
475-050F	5	1	
475-060	6	3	
475-080	8	1	
475-100	10	1	
475-120	12	1	
1/2" - 2" 235 PSI Max. Rating @ 73°F			
2-1/2" - 6" 150 PSI Max. Rating @ 73°F			
8" - 12" 100 PSI Max. Rating @ 73°F			

COMPRESSION TEE (c x c x soc)



Part No.	Size-In.	Box	Price
CPT-0500-S	1/2	24	
CPT-0750-S	3/4	20	
CPT-1000-S	1	12	
CPT-1250-S	1-1/4	8	
CPT-1500-S	1-1/2	6	
CPT-2000-S	2	5	

INSERT ADAPTER (insert x spig)



Part No.	Size-In.	Box	Price
460-005	1/2	50	
460-007	3/4	50	
460-010	1	50	
460-012	1-1/4	20	
460-015	1-1/2	25	
460-020	2	10	
460-030	3	25	
460-040	4	10	
1432-060	6	8	
1432-080	8	4	

COMPRESSION TEE (c x c x fipt)



Part No.	Size-In.	Box	Price
CPT-0500-T	1/2	24	
CPT-0750-T	3/4	20	
CPT-1000-T	1	12	
CPT-1250-T	1-1/4	8	
CPT-1500-T	1-1/2	6	
CPT-2000-T	2	5	

SNAP ON SADDLE (IPS O.D. x soc)



Part No.	Size-In.	Box	Price
463-005	1/2	25	
463-007	3/4	25	
463-010	1	50	
463-012	1-1/4	50	
463-015	1-1/2	25	
463-020	2	20	
463-101	3/4 x 1/2	25	
463-130	1 x 1/2	50	

DOUBLE WYE (soc x soc x soc x soc)



Part No.	Size-In.	Box	Price
476-020F	2	1	
476-030F	3	1	
476-040F	4	1	
476-060F	6	1	
476-080F	8	1	
476-100F	10	1	
476-120F	12	1	
100 PSI Max. Rating @ 73°F			

COMPRESSION MALE ADAPTER (c x mipt)



Part No.	Size-In.	Box	Price
CPA-0500	1/2	12	
CPA-0750	3/4	12	
CPA-1000	1	24	
CPA-1250	1-1/4	18	
CPA-1500	1-1/2	16	
CPA-2000	2	17	

ULTRAVIOLET RESISTANT SCHEDULE 40 PVC FITTINGS

TEE (soc x soc x soc)



Part No.	Size-In.	Box	Price
401-005UV	1/2	50	
401-007UV	3/4	50	
401-010UV	1	50	
401-012UV	1-1/4	25	
401-015UV	1-1/2	25	
401-020UV	2	25	
401-025UV	2-1/2	10	
401-030UV	3	10	
401-040UV	4	6	

TEE (soc x soc x fipt)



Part No.	Size-In.	Box	Price
402-005UV	1/2	50	
402-007UV	3/4	50	

REDUCING TEE (soc x soc x fipt)



Part No.	Size-In.	Box	Price
402-101UV	3/4 x 3/4 x 1/2	50	
402-130UV	1 x 1 x 1/2	50	
402-131UV	1 x 1 x 3/4	50	
402-166UV	1-1/4 x 1-1/4 x 1/2	25	
402-167UV	1-1/4 x 1-1/4 x 3/4	25	
402-209UV	1-1/2 x 1-1/2 x 1/2	25	
402-210UV	1-1/2 x 1-1/2 x 3/4	25	
402-247UV	2 x 2 x 1/2	10	
402-248UV	2 x 2 x 3/4	10	

90° ELBOW (soc x soc)



Part No.	Size-In.	Box	Price
406-005UV	1/2	50	
406-007UV	3/4	50	
406-010UV	1	50	
406-012UV	1-1/4	25	
406-015UV	1-1/2	25	
406-020UV	2	25	
406-025UV	2-1/2	10	
406-030UV	3	10	
406-040UV	4	8	

90° ELBOW (soc x fipt)



Part No.	Size-In.	Box	Price
407-005UV	1/2	50	
407-007UV	3/4	50	
407-101UV	3/4 x 1/2	50	
407-131UV	1 x 3/4	50	

90° STREET ELBOW (mipt x fipt)



Part No.	Size-In.	Box	Price
412-005UV	1/2	50	
412-007UV	3/4	50	

45° ELBOW (soc x soc)



Part No.	Size-In.	Box	Price
417-005UV	1/2	50	
417-007UV	3/4	50	
417-010UV	1	50	
417-012UV	1-1/4	25	
417-015UV	1-1/2	25	
417-020UV	2	25	
417-025UV	2-1/2	10	
417-030UV	3	10	
417-040UV	4	5	

COUPLING (soc x soc)



Part No.	Size-In.	Box	Price
429-005UV	1/2	50	
429-007UV	3/4	50	
429-010UV	1	50	
429-012UV	1-1/4	25	
429-015UV	1-1/2	25	
429-020UV	2	25	
429-025UV	2-1/2	12	
429-030UV	3	10	
429-040UV	4	6	

THREADED COUPLING (fipt x fipt)



Part No.	Size-In.	Box	Price
430-005UV	1/2	50	
430-007UV	3/4	50	

FEMALE ADAPTER (soc x fipt)



Part No.	Size-In.	Box	Price
435-005UV	1/2	50	
435-007UV	3/4	50	

MALE ADAPTER (mipt x soc)



Part No.	Size-In.	Box	Price
436-005UV	1/2	50	
436-007UV	3/4	50	
436-010UV	1	50	
436-012UV	1-1/4	25	
436-015UV	1-1/2	25	
436-020UV	2	25	
436-025UV	2-1/2	10	
436-030UV	3	10	
436-074UV	1/2 x 3/4	50	

REDUCER BUSHING (spig x soc)



Part No.	Size-In.	Box	Price
437-101UV	3/4 x 1/2	50	
437-130UV	1 x 1/2	50	
437-131UV	1 x 3/4	50	
437-167UV	1-1/4 x 3/4	25	
437-168UV	1-1/4 x 1	25	
437-210UV	1-1/2 x 3/4	25	
437-211UV	1-1/2 x 1	25	
437-212UV	1-1/2 x 1-1/4	25	
437-249UV	2 x 1	10	
437-250UV	2 x 1-1/4	10	
437-251UV	2 x 1-1/2	25	
437-288UV	2-1/2 x 3/4	10	
437-289UV	2-1/2 x 1	10	
437-290UV	2-1/2 x 1-1/4	10	
437-292UV	2-1/2 x 2	10	
437-335UV	3 x 1	10	
437-336UV	3 x 1-1/4	10	
437-337UV	3 x 1-1/2	10	
437-338UV	3 x 2	10	
437-339UV	3 x 2-1/2	10	
437-422UV	4 x 3	6	

REDUCER BUSHING (spig x fipt)



Part No.	Size-In.	Box	Price
438-130UV	1 x 1/2	50	
438-131UV	1 x 3/4	50	

SCHEDULE 80 NIPPLE



Part No.	Size-In.	Box	Price
882-060UV	1/2 x 6	25	
882-080UV	1/2 x 8	25	
882-100UV	1/2 x 10	25	
882-120UV	1/2 x 12	25	
883-060UV	3/4 x 6	25	
883-080UV	3/4 x 8	25	
883-100UV	3/4 x 10	25	
883-120UV	3/4 x 12	25	

PVC CLEAR SCHEDULE 40 PIPE & FITTINGS

SCH. 40 PIPE (10 ft. lengths)



Part No.	Size-In.	Box	Price / Ft.
PL-002	1/4	10	
PL-003	3/8	10	
PL-005	1/2	10	
PL-007	3/4	10	
PL-010	1	10	
PL-012	1-1/4	10	
PL-015	1-1/2	10	
PL-020	2	10	
PL-025	2-1/2	10	
PL-030	3	10	
PL-040	4	10	
PL-060	6	10	
PL-080	8	10	

45° ELL (soc x soc)



Part No.	Size-In.	Box	Price
417-002L	1/4	25	
417-003L	3/8	25	
417-005L	1/2	50	
417-007L	3/4	50	
417-010L	1	50	
417-012L	1-1/4	25	
417-015L	1-1/2	25	
417-020L	2	10	
417-025L	2-1/2	10	
417-030L	3	10	
417-040L	4	5	
417-060L	6	8	
417-080L	8	3	

MALE ADAPTER (mipt x soc)



Part No.	Size-In.	Box	Price
436-003L	3/8	50	
436-005L	1/2	50	
436-007L	3/4	50	
436-010L	1	50	
436-012L	1-1/4	25	
436-015L	1-1/2	25	
436-020L	2	25	
436-025L	2-1/2	10	
436-030L	3	10	
436-040L	4	5	

TEE (soc x soc x soc)



Part No.	Size-In.	Box	Price
401-002L	1/4	25	
401-003L	3/8	50	
401-005L	1/2	50	
401-007L	3/4	50	
401-010L	1	50	
401-012L	1-1/4	25	
401-015L	1-1/2	25	
401-020L	2	10	
401-025L	2-1/2	10	
401-030L	3	10	
401-040L	4	6	
401-060L	6	4	
401-080L	8	2	

45° STREET ELL (spig x soc)



Part No.	Size-In.	Box	Price
427-005L	1/2	50	
427-007L	3/4	50	
427-010L	1	50	
427-012L	1-1/4	25	
427-015L	1-1/2	25	
427-020L	2	25	
427-025L	2-1/2	10	
427-030L	3	10	
427-040L	4	5	

REDUCER BUSHING (spig x soc)



Part No.	Size-In.	Box	Price
437-101L	3/4 x 1/2	50	
437-131L	1 x 3/4	50	
437-168L	1-1/4 x 1	25	
437-211L	1-1/2 x 1	25	
437-212L	1-1/2 x 1-1/4	25	
437-251L	2 x 1-1/2	10	
437-292L	2-1/2 x 2	10	
437-338L	3 x 2	10	
437-339L	3 x 2-1/2	10	
437-422L	4 x 3	6	
437-532L	6 x 4	5	
437-585L	8 x 6	4	

90° ELL (soc x soc)



Part No.	Size-In.	Box	Price
406-002L	1/4	25	
406-003L	3/8	50	
406-005L	1/2	50	
406-007L	3/4	50	
406-010L	1	50	
406-012L	1-1/4	25	
406-015L	1-1/2	25	
406-020L	2	25	
406-025L	2-1/2	10	
406-030L	3	10	
406-040L	4	8	
406-060L	6	5	
406-080L	8	2	

COUPLING (soc x soc)



Part No.	Size-In.	Box	Price
429-002L	1/4	25	
429-003L	3/8	50	
429-005L	1/2	50	
429-007L	3/4	50	
429-010L	1	50	
429-012L	1-1/4	25	
429-015L	1-1/2	25	
429-020L	2	10	
429-025L	2-1/2	10	
429-030L	3	10	
429-040L	4	6	
429-060L	6	5	
429-080L	8	6	

CAP (soc)



Part No.	Size-In.	Box	Price
447-002L	1/4	25	
447-003L	3/8	50	
447-005L	1/2	50	
447-007L	3/4	50	
447-010L	1	50	
447-012L	1-1/4	25	
447-015L	1-1/2	25	
447-020L	2	10	
447-025L	2-1/2	10	
447-030L	3	10	
447-040L	4	6	
447-060L	6	4	
447-080L	8	3	

90° STREET ELL (spig x soc)



Part No.	Size-In.	Box	Price
409-005L	1/2	50	
409-007L	3/4	50	
409-010L	1	50	
409-012L	1-1/4	25	
409-015L	1-1/2	25	
409-020L	2	10	
409-025L	2-1/2	10	

FEMALE ADAPTER (soc x sr fipt)



Part No.	Size-In.	Box	Price
435-002SRL	1/4	25	
435-003SRL	3/8	25	
435-005SRL	1/2	25	
435-007SRL	3/4	25	
435-010SRL	1	25	
435-012SRL	1-1/4	10	
435-015SRL	1-1/2	10	
435-020SRL	2	10	
435-025SRL	2-1/2	5	
435-030SRL	3	10	
435-040SRL	4	6	

WYES & REDUCING WYES (soc x soc x soc)



Part No.	Size-In.	Box	Price
475-015L	1-1/2	20	
475-020L	2	10	
475-030L	3	4	
475-040L	4	4	
475-060L	6	3	
475-532L	6 x 4	5	

SCHEDULE 80 PVC FITTINGS

TEE (soc x soc x soc)



Part No.	Size-In.	Box	Price
801-005	1/2	25	
801-007	3/4	15	
801-010	1	15	
801-012	1-1/4	10	
801-015	1-1/2	10	
801-020	2	10	
801-025	2-1/2	10	
801-030	3	5	
801-040	4	5	
801-060	6	4	
801-080	8	2	
801-100	10	1	
801-120	12	1	

REDUCING TEE (soc x soc x soc)



Part No.	Size-In.	Box	Price
801-101	3/4 x 3/4 x 1/2	15	
801-130	1 x 1 x 1/2	15	
801-131	1 x 1 x 3/4	15	
801-157	1-1/4 x 1 x 3/4	15	
801-158	1-1/4 x 1 x 1	15	
801-159	1-1/4 x 1 x 1-1/4	15	
801-166	1-1/4 x 1-1/4 x 1/2	10	
801-167	1-1/4 x 1-1/4 x 3/4	10	
801-168	1-1/4 x 1-1/4 x 1	15	
801-202	1-1/2 x 1-1/4 x 1	10	
801-209	1-1/2 x 1-1/2 x 1/2	10	
801-210	1-1/2 x 1-1/2 x 3/4	15	
801-211	1-1/2 x 1-1/2 x 1	10	
801-212	1-1/2 x 1-1/2 x 1-1/4	10	
801-247	2 x 2 x 1/2	10	
801-248	2 x 2 x 3/4	10	
801-249	2 x 2 x 1	10	
801-250	2 x 2 x 1-1/4	10	
801-251	2 x 2 x 1-1/2	10	
801-287	2-1/2 x 2-1/2 x 1/2	10	
801-288	2-1/2 x 2-1/2 x 3/4	10	
801-289	2-1/2 x 2-1/2 x 1	10	
801-290	2-1/2 x 2-1/2 x 1-1/4	10	
801-291	2-1/2 x 2-1/2 x 1-1/2	10	
801-292	2-1/2 x 2-1/2 x 2	10	
801-333	3 x 3 x 1/2	5	
801-334	3 x 3 x 3/4	5	
801-335	3 x 3 x 1	5	
801-336	3 x 3 x 1-1/4	5	
801-337	3 x 3 x 1-1/2	5	
801-338	3 x 3 x 2	5	
801-339	3 x 3 x 2-1/2	5	
801-416	4 x 4 x 3/4	5	
801-417	4 x 4 x 1	5	
801-418	4 x 4 x 1-1/4	5	
801-419	4 x 4 x 1-1/2	5	
801-420	4 x 4 x 2	5	
801-421	4 x 4 x 2-1/2	5	
801-422	4 x 4 x 3	5	
801-426	4 x 4 x 6	4	
801-525	6 x 6 x 1	4	
801-526	6 x 6 x 1-1/4	4	
801-527	6 x 6 x 1-1/2	4	
801-528	6 x 6 x 2	4	
801-529	6 x 6 x 2-1/2	4	
801-530	6 x 6 x 3	4	
801-532	6 x 6 x 4	5	
801-578	8 x 8 x 2	2	
801-579	8 x 8 x 2-1/2	2	
801-580	8 x 8 x 3	2	
801-582	8 x 8 x 4	2	

REDUCING TEE - Continued (soc x soc x soc)



Part No.	Size-In.	Box	Price
801-585	8 x 8 x 6	2	
801-623	10 x 10 x 3	1	
801-624	10 x 10 x 4	1	
801-626	10 x 10 x 6	1	
801-628	10 x 10 x 8	1	
801-664	12 x 12 x 4	1	
801-666	12 x 12 x 6	1	
801-668	12 x 12 x 8	1	
801-670	12 x 12 x 10	1	

STREET TEE (spig x soc x soc)



Part No.	Size-In.	Box	Price
844-005	1/2	25	
844-007	3/4	15	
844-010	1	15	
844-012	1-1/4	10	
844-015	1-1/2	10	
844-020	2	10	

TEE (soc x soc x fipt)



Part No.	Size-In.	Box	Price
802-005	1/2	20	
802-007	3/4	15	
802-010	1	15	
802-012	1-1/4	15	
802-015	1-1/2	10	
802-020	2	10	
802-030	3	5	

REDUCING TEE (soc x soc x fipt)



Part No.	Size-In.	Box	Price
802-101	3/4 x 3/4 x 1/2	15	
802-130	1 x 1 x 1/2	15	
802-131	1 x 1 x 3/4	15	
802-166	1-1/4 x 1-1/4 x 1/2	10	
802-167	1-1/4 x 1-1/4 x 3/4	15	
802-168	1-1/4 x 1-1/4 x 1	10	
802-209	1-1/2 x 1-1/2 x 1/2	25	
802-210	1-1/2 x 1-1/2 x 3/4	20	
802-211	1-1/2 x 1-1/2 x 1	10	
802-212	1-1/2 x 1-1/2 x 1-1/4	10	
802-247	2 x 2 x 1/2	10	
802-248	2 x 2 x 3/4	10	
802-249	2 x 2 x 1	10	
802-250	2 x 2 x 1-1/4	10	
802-251	2 x 2 x 1-1/2	10	
802-287	2-1/2 x 2-1/2 x 1/2	10	
802-288	2-1/2 x 2-1/2 x 3/4	10	
802-289	2-1/2 x 2-1/2 x 1	10	
802-290	2-1/2 x 2-1/2 x 1-1/4	10	
802-291	2-1/2 x 2-1/2 x 1-1/2	10	
802-292	2-1/2 x 2-1/2 x 2	10	
802-333	3 x 3 x 1/2	5	
802-334	3 x 3 x 3/4	5	
802-335	3 x 3 x 1	5	
802-336	3 x 3 x 1-1/4	5	
802-337	3 x 3 x 1-1/2	5	
802-338	3 x 3 x 2	5	
802-339	3 x 3 x 2-1/2	5	
802-415	4 x 4 x 1/2	5	
802-416	4 x 4 x 3/4	5	
802-417	4 x 4 x 1	5	

REDUCING TEE - Continued (soc x soc x fipt)



Part No.	Size-In.	Box	Price
802-418	4 x 4 x 1-1/4	1	
802-419	4 x 4 x 1-1/2	5	
802-420	4 x 4 x 2	5	
802-421	4 x 4 x 2-1/2	5	
802-422	4 x 4 x 3	5	
802-525	6 x 6 x 1	4	
802-526	6 x 6 x 1-1/4	4	
802-527	6 x 6 x 1-1/2	4	
802-528	6 x 6 x 2	4	
802-529	6 x 6 x 2-1/2	4	
802-530	6 x 6 x 3	4	
802-532	6 x 6 x 4	2	
802-578	8 x 8 x 2	2	
802-580	8 x 8 x 3	1	
802-582	8 x 8 x 4	2	
802-621	10 x 10 x 2	1	
802-623	10 x 10 x 3	1	
802-624	10 x 10 x 4	1	
802-661	12 x 12 x 2	1	
802-663	12 x 12 x 3	1	
802-664	12 x 12 x 4	1	

THREADED TEE (fipt x fipt x fipt)



Part No.	Size-In.	Box	Price
805-005	1/2	20	
805-007	3/4	15	
805-010	1	15	
805-012	1-1/4	10	
805-015	1-1/2	10	
805-020	2	10	
805-025	2-1/2	5	
805-030	3	5	
805-040	4	5	

90° ELBOW (soc x soc)



Part No.	Size-In.	Box	Price
806-005	1/2	20	
806-007	3/4	20	
806-010	1	10	
806-012	1-1/4	10	
806-015	1-1/2	10	
806-020	2	25	
806-025	2-1/2	5	
806-030	3	5	
806-040	4	5	
806-050	5	4	
806-060	6	4	
806-080	8	2	
806-100	10	1	
806-120	12	1	

90° SWEEP ELBOW (soc x soc)



Part No.	Size-In.	Box	Price
806-005S	1/2	25	
806-007S	3/4	25	
806-010S	1	25	
806-012S	1-1/4	25	
806-015S	1-1/2	25	
806-020S	2	25	

INTRO 1. ELECTRICAL 2. PUMP ACC. 3. HOSE, PE PIPE & ACC. 4. IPS, PIP PIPE & ACC. 5. SURFACE 6. SPRINKLERS 7. TRAVELER & WHEEL MOVE 8. PIVOT 9. TURF 10. LOW VOLUME 11. FILTERS 12. INJECTION 13. HARDWARE INDEX

SCHEDULE 80 PVC FITTINGS

90° LONG SWEEP ELBOW (soc x soc)



Part No.	Size-In.	Box	Price
806-005LSF	1/2	25	
806-007LSF	3/4	25	
806-010LSF	1	25	
806-012LSF	1-1/4	25	
806-015LSF	1-1/2	25	
806-020LSF	2	10	
806-025LSF	2-1/2	1	
806-030LSF	3	5	
806-040LSF	4	4	
806-060LSF	6	1	

90° STREET ELBOW (spig x soc)



Part No.	Size-In.	Box	Price
809-005	1/2	50	
809-007	3/4	50	
809-010	1	50	
809-012	1-1/4	25	
809-015	1-1/2	10	
809-020	2	25	
809-030	3	5	
809-040	4	4	
809-060	6	1	
809-080	8	2	
809-100	10	1	
809-120	12	1	

45° ELBOW (fipt x fipt)



Part No.	Size-In.	Box	Price
819-002	1/4	25	
819-005	1/2	20	
819-007	3/4	10	
819-010	1	10	
819-012	1-1/4	10	
819-015	1-1/2	10	
819-020	2	10	
819-025	2-1/2	5	
819-030	3	5	
819-040	4	5	

90° ELBOW (soc x fipt)



Part No.	Size-In.	Box	Price
807-002	1/4	25	
807-005	1/2	20	
807-007	3/4	20	
807-010	1	20	
807-012	1-1/4	10	
807-015	1-1/2	10	
807-020	2	10	
807-030	3	5	
807-040	4	5	
807-060	6	4	

60° ELBOW (soc x soc)



Part No.	Size-In.	Box	Price
824-005F	1/2	1	
824-007F	3/4	1	
824-010F	1	1	
824-012F	1-1/4	1	
824-015F	1-1/2	1	
824-020F	2	1	
824-025F	2-1/2	10	
824-030F	3	1	
824-040F	4	1	
824-060F	6	1	
824-080F	8	1	
824-100F	10	1	
824-120F	12	1	

30° ELBOW (soc x soc)



Part No.	Size-In.	Box	Price
815-005F	1/2	1	
815-007F	3/4	1	
815-010F	1	1	
815-012F	1-1/4	1	
815-015F	1-1/2	25	
815-020F	2	25	
815-025F	2-1/2	18	
815-030F	3	1	
815-040F	4	1	
815-060	6	5	
815-080F	8	1	
815-100F	10	1	
815-120F	12	1	

90° REDUCING ELBOW (soc x fipt)



Part No.	Size-In.	Box	Price
807-101	3/4 x 1/2	10	
807-130	1 x 1/2	10	
807-131	1 x 3/4	10	

45° ELBOW (soc x soc)



Part No.	Size-In.	Box	Price
817-005	1/2	20	
817-007	3/4	20	
817-010	1	15	
817-012	1-1/4	10	
817-015	1-1/2	10	
817-020	2	10	
817-025	2-1/2	5	
817-030	3	5	
817-040	4	5	
817-060	6	4	
817-080	8	2	
817-100	10	1	
817-120	12	1	

22-1/2° ELBOW (soc x soc)



Part No.	Size-In.	Box	Price
816-005	1/2	20	
816-007	3/4	20	
816-010	1	20	
816-012	1-1/4	20	
816-015	1-1/2	20	
816-020	2	20	
816-025	2-1/2	5	
816-030	3	5	
816-040	4	4	
816-060	6	4	
816-080	8	4	
816-100F	10	1	
816-120F	12	1	

90° THREADED ELBOW (fipt x fipt)



Part No.	Size-In.	Box	Price
808-002	1/4	25	
808-005	1/2	20	
808-007	3/4	20	
808-010	1	15	
808-012	1-1/4	10	
808-015	1-1/2	10	
808-020	2	10	
808-025	2-1/2	5	
808-030	3	5	
808-040	4	5	

45° STREET ELBOW (spig x soc)



Part No.	Size-In.	Box	Price
827-005	1/2	50	
827-007	3/4	50	
827-010	1	50	
827-012	1-1/4	25	
827-015	1-1/2	25	
827-020	2	10	
827-025	2-1/2	12	
827-030	3	10	
827-040	4	5	
827-060	6	4	
827-080	8	2	
827-100	10	1	
827-120	12	1	

22-1/2° STREET ELBOW (spig x soc)



Part No.	Size-In.	Box	Price
842-005	1/2	50	
842-007	3/4	50	
842-010	1	50	
842-012	1-1/4	20	
842-015	1-1/2	25	
842-020	2	20	
842-025	2-1/2	1	
842-030	3	5	
842-040	4	4	
842-060	6	6	
842-080	8	1	
842-100F	10	1	

90° STREET ELBOW (mipt x fipt)



Part No.	Size-In.	Box	Price
812-002	1/4	50	

SCHEDULE 80 PVC FITTINGS



15° ELBOW (soc x soc)

Part No.	Size-In.	Box	Price
818-005F	1/2	1	
818-007F	3/4	1	
818-010F	1	1	
818-012F	1-1/4	15	
818-015F	1-1/2	1	
818-020F	2	25	
818-025F	2-1/2	18	
818-030F	3	1	
818-040F	4	1	
818-060F	6	1	
818-080F	8	1	
818-100F	10	1	
818-120F	12	1	



DOUBLE WYE (soc x soc x soc x soc)

Part No.	Size-In.	Box	Price
876-020F	2	1	
876-030F	3	1	
876-040F	4	1	
876-060F	6	1	
876-080F	8	1	
876-100F	10	1	
876-120F	12	1	

100 PSI Max. rating @ 73°F



REDUCER COUPLING - Continued (soc x soc)

Part No.	Size-In.	Box	Price
829-250	2 x 1-1/4	10	
829-251	2 x 1-1/2	10	
829-291	2-1/2 x 1-1/2	10	
829-292	2-1/2 x 2	10	
829-335	3 x 1	8	
829-336	3 x 1-1/4	6	
829-337	3 x 1-1/2	8	
829-338	3 x 2	8	
829-339	3 x 2-1/2	5	
829-416	4 x 3/4	4	
829-417	4 x 1	4	
829-419	4 x 1-1/2	4	
829-420	4 x 2	4	
829-421	4 x 2-1/2	4	
829-422	4 x 3	4	
829-528	6 x 2	6	
829-529	6 x 2-1/2	4	
829-530	6 x 3	12	
829-532	6 x 4	4	
829-579F	8 x 2-1/2	1	
829-580F	8 x 3	1	
829-582F	8 x 4	1	
829-585	8 x 6	2	
829-621F	10 x 2	1	
829-623F	10 x 3	1	
829-624F	10 x 4	1	
829-626F	10 x 6	1	
829-628	10 x 8	1	
829-663F	12 x 3	1	
829-664F	12 x 4	1	
829-666F	12 x 6	1	
829-668F	12 x 8	1	
829-670F	12 x 10	1	



CROSS (soc x soc x soc x soc)

Part No.	Size-In.	Box	Price
820-005	1/2	50	
820-007	3/4	50	
820-010	1	50	
820-012	1-1/4	25	
820-015	1-1/2	25	
820-020	2	10	
820-025	2-1/2	10	
820-030	3	5	
820-040	4	3	
820-060F	6	1	
820-080F	8	1	
820-100F	10	1	
820-120F	12	1	



11-1/4° ELBOW (soc x soc)

Part No.	Size-In.	Box	Price
811-005F	1/2	1	
811-007F	3/4	1	
811-010F	1	50	
811-012F	1-1/4	1	
811-015	1-1/2	1	
811-020	2	10	
811-025F	2-1/2	25	
811-030	3	10	
811-040	4	4	
811-060F	6	1	
811-080F	8	1	
811-100F	10	1	
811-120F	12	1	



COUPLING (soc x soc)

Part No.	Size-In.	Box	Price
829-005	1/2	25	
829-007	3/4	15	
829-010	1	25	
829-012	1-1/4	10	
829-015	1-1/2	10	
829-020	2	20	
829-025	2-1/2	10	
829-030	3	5	
829-040	4	5	
829-060	6	4	
829-080	8	4	
829-100	10	1	
829-120	12	1	



WYE (soc x soc x soc)

Part No.	Size-In.	Box	Price
875-005	1/2	25	
875-007	3/4	25	
875-010	1	20	
875-012	1-1/4	20	
875-015	1-1/2	20	
875-020	2	10	
875-025	2-1/2	4	
875-030	3	5	
875-040	4	4	
875-060	6	3	
875-080	8	1	
875-100F	10	1	
875-120F	12	1	

1/2" - 2" 235 PSI Max. Rating @ 73°F
3" - 6" 150 PSI Max. Rating @ 73°F
8" - 12" 100 PSI Max. Rating @ 73°F



REDUCER COUPLING (soc x soc)

Part No.	Size-In.	Box	Price
829-101	3/4 x 1/2	50	
829-130	1 x 1/2	25	
829-131	1 x 3/4	25	
829-166	1-1/4 x 1/2	25	
829-167	1-1/4 x 3/4	25	
829-168	1-1/4 x 1	25	
829-209	1-1/2 x 1/2	25	
829-210	1-1/2 x 3/4	25	
829-211	1-1/2 x 1	25	
829-212	1-1/2 x 1-1/4	25	
829-247	2 x 1/2	25	
829-248	2 x 3/4	10	
829-249	2 x 1	16	

THREADED COUPLING (fip x fip)

Part No.	Size-In.	Box	Price
830-002	1/4"	25	
830-005	1/2	25	
830-007	3/4	25	
830-010	1	15	
830-012	1-1/4	10	
830-015	1-1/2	10	
830-020	2	10	
830-025	2-1/2	5	
830-030	3	5	
830-040	4	5	
830-060F	6	1	
830-080F	8	1	
830-100F	10	1	
830-101	3/4 x 1/2	50	

GROOVED COUPLING ADAPTER (groove x soc)

Part No.	Size-In.	Box	Price
833-012	1-1/4	10	
833-015	1-1/2	10	
833-020	2	5	
833-025	2-1/2	5	
833-030	3	5	
833-040	4	5	
833-060	6	5	

SCHEDULE 80 PVC FITTINGS

FEMALE ADAPTER (soc x fipt)



Part No.	Size-In.	Box	Price
835-002	1/4	25	
835-005	1/2	25	
835-007	3/4	15	
835-010	1	15	
835-012	1-1/4	10	
835-015	1-1/2	10	
835-020	2	10	
835-025	2-1/2	5	
835-030	3	5	
835-040	4	5	
835-060	6	6	
835-080	8	3	
835-100F	10	1	
835-120F	12	1	

MALE ADAPTER (mipt x soc)



Part No.	Size-In.	Box	Price
836-005	1/2	25	
836-007	3/4	25	
836-010	1	10	
836-012	1-1/4	10	
836-015	1-1/2	10	
836-020	2	10	
836-025	2-1/2	5	
836-030	3	5	
836-040	4	5	
836-060	6	5	
836-080F	8	1	
836-100F	10	1	
836-120F	12	1	

MALE ADAPTER (spig x mipt)



Part No.	Size-In.	Box	Price
861-005	1/2	50	
861-007	3/4	25	
861-010	1	50	
861-012	1-1/4	25	
861-015	1-1/2	25	
861-020	2	25	

REDUCER BUSHING (spig x soc)



Part No.	Size-In.	Box	Price
837-101	3/4 x 1/2	50	
837-130	1 x 1/2	50	
837-131	1 x 3/4	50	
837-166	1-1/4 x 1/2	25	
837-167	1-1/4 x 3/4	25	
837-168	1-1/4 x 1	25	
837-209	1-1/2 x 1/2	25	
837-210	1-1/2 x 3/4	25	
837-211	1-1/2 x 1	25	
837-212	1-1/2 x 1-1/4	25	
837-247	2 x 1/2	10	
837-248	2 x 3/4	10	
837-249	2 x 1	10	
837-250	2 x 1-1/4	10	
837-251	2 x 1-1/2	10	
837-287	2-1/2 x 1/2	5	
837-288	2-1/2 x 3/4	5	
837-289	2-1/2 x 1	5	

REDUCER BUSHING - Continued (spig x soc)



Part No.	Size-In.	Box	Price
837-290	2-1/2 x 1-1/4	10	
837-291	2-1/2 x 1-1/2	10	
837-292	2-1/2 x 2	15	
837-335	3 x 1	10	
837-336	3 x 1-1/4	10	
837-337	3 x 1-1/2	10	
837-338	3 x 2	10	
837-339	3 x 2-1/2	15	
837-417	4 x 1	6	
837-418	4 x 1-1/4	6	
837-419	4 x 1-1/2	6	
837-420	4 x 2	6	
837-421	4 x 2-1/2	6	
837-422	4 x 3	6	
837-524	6 x 3/4	5	
837-525	6 x 1	5	
837-526	6 x 1-1/4	5	
837-527	6 x 1-1/2	5	
837-528	6 x 2	5	
837-529	6 x 2-1/2	5	
837-530	6 x 3	5	
837-532	6 x 4	5	
837-577	8 x 1-1/2	4	
837-578	8 x 2	4	
837-580	8 x 3	6	
837-582	8 x 4	6	
837-585	8 x 6	4	
837-621	10 x 2	2	
837-622	10 x 2-1/2	2	
837-623	10 x 3	2	
837-624	10 x 4	2	
837-626	10 x 6	4	
837-628	10 x 8	4	
837-663	12 x 3	2	
837-664	12 x 4	2	
837-666	12 x 6	2	
837-668	12 x 8	2	
837-670	12 x 10	2	

REDUCER BUSHING (spig x fipt)



Part No.	Size-In.	Box	Price
838-071	1/2 x 1/8	50	
838-072	1/2 x 1/4	50	
838-098	3/4 x 1/4	50	
838-101	3/4 x 1/2	50	
838-127	1 x 1/8	25	
838-130	1 x 1/2	50	
838-131	1 x 3/4	50	
838-166	1-1/4 x 1/2	25	
838-167	1-1/4 x 3/4	25	
838-168	1-1/4 x 1	25	
838-206	1-1/2 x 1/8	25	
838-207	1-1/2 x 1/4	25	
838-209	1-1/2 x 1/2	25	
838-210	1-1/2 x 3/4	25	
838-211	1-1/2 x 1	25	
838-212	1-1/2 x 1-1/4	25	
838-247	2 x 1/2	10	
838-248	2 x 3/4	10	
838-249	2 x 1	10	
838-250	2 x 1-1/4	10	
838-251	2 x 1-1/2	10	
838-287	2-1/2 x 1/2	10	
838-288	2-1/2 x 3/4	10	
838-289	2-1/2 x 1	10	

REDUCER BUSHING - Continued (spig x fipt)



Part No.	Size-In.	Box	Price
838-290	2-1/2 x 1-1/4	10	
838-291	2-1/2 x 1-1/2	10	
838-292	2-1/2 x 2	10	
838-334	3 x 3/4	10	
838-335	3 x 1	10	
838-336	3 x 1-1/4	10	
838-337	3 x 1-1/2	10	
838-338	3 x 2	10	
838-339	3 x 2-1/2	10	
838-419	4 x 1-1/2	6	
838-420	4 x 2	6	
838-421	4 x 2-1/2	6	
838-422	4 x 3	6	
838-528	6 x 2	5	
838-530	6 x 3	5	
838-532	6 x 4	5	

THREADED BUSHING (mipt x fipt)



Part No.	Size-In.	Box	Price
839-072	1/2 x 1/4	50	
839-073	1/2 x 3/8	50	
839-098	3/4 x 1/4	50	
839-099	3/4 x 3/8	50	
839-101	3/4 x 1/2	50	
839-128	1 x 1/4	25	
839-129	1 x 3/8	50	
839-130	1 x 1/2	50	
839-131	1 x 3/4	50	
839-166	1-1/4 x 1/2	25	
839-167	1-1/4 x 3/4	25	
839-168	1-1/4 x 1	25	
839-209	1-1/2 x 1/2	25	
839-210	1-1/2 x 3/4	25	
839-211	1-1/2 x 1	25	
839-212	1-1/2 x 1-1/4	25	
839-247	2 x 1/2	10	
839-248	2 x 3/4	10	
839-249	2 x 1	10	
839-250	2 x 1-1/4	10	
839-251	2 x 1-1/2	10	
839-292	2-1/2 x 2	10	
839-337	3 x 1-1/2	10	
839-338	3 x 2	10	
839-339	3 x 2-1/2	10	
839-420	4 x 2	6	
839-422	4 x 3	6	

CAP (soc)



Part No.	Size-In.	Box	Price
847-005	1/2	25	
847-007	3/4	25	
847-010	1	15	
847-012	1-1/4	10	
847-015	1-1/2	10	
847-020	2	10	
847-025	2-1/2	5	
847-030	3	5	
847-040	4	5	
847-060	6	4	
847-080	8	3	
847-100F	10	1	
847-120F	12	1	

SCHEDULE 80 PVC FITTINGS



THREADED CAP
(fipt)

Part No.	Size-In.	Box	Price
848-002	1/4	25	
848-005	1/2	25	
848-007	3/4	25	
848-010	1	15	
848-012	1-1/4	10	
848-015	1-1/2	10	
848-020	2	10	
848-025	2-1/2	5	
848-030	3	5	
848-040	4	5	
848-060F	6	1	
848-080F	8	1	



VAN STONE FLANGE
(soc)

Part No.	Size-In.	Box	Price
854-005	1/2	25	
854-007	3/4	25	
854-010	1	15	
854-012	1-1/4	15	
854-015	1-1/2	20	
854-020	2	10	
854-025	2-1/2	10	
854-030	3	10	
854-040	4	5	
854-060	6	4	
854-080	8	2	
854-100	10	2	
854-120	12	2	



UNION
(soc x soc)

Part No.	Size-In.	Box	Price
8057-005	1/2	20	
8057-007	3/4	20	
8057-010	1	15	
8057-012	1-1/4	10	
8057-015	1-1/2	10	
8057-020	2	5	
8057-025	2-1/2	5	
8057-030	3	5	
8057-040	4	4	
8057-060	6	1	



PLUG
(spig)

Part No.	Size-In.	Box	Price
849-005	1/2	50	
849-007	3/4	50	
849-010	1	50	
849-012	1-1/4	25	
849-015	1-1/2	10	
849-020	2	10	
849-025F	2-1/2	1	
849-030F	3	1	
849-040F	4	1	
849-060F	6	1	
849-080F	8	1	
849-100F	10	1	
849-120F	12	1	



THREADED VAN STONE FLANGE
(fipt)

Part No.	Size-In.	Box	Price
855-005	1/2	25	
855-007	3/4	25	
855-010	1	15	
855-012	1-1/4	15	
855-015	1-1/2	20	
855-020	2	10	
855-025	2-1/2	10	
855-030	3	10	
855-040	4	5	
855-060	6	1	
855-080	8	1	
855-100F	10	1	



THREADED UNION
(fipt x fipt)

Part No.	Size-In.	Box	Price
8058-005	1/2	20	
8058-007	3/4	20	
8058-010	1	15	
8058-012	1-1/4	10	
8058-015	1-1/2	10	
8058-020	2	5	
8058-025	2-1/2	5	
8058-030	3	5	
8058-040	4	4	
8058-060	6	1	



THREADED PLUG
(mpt)

Part No.	Size-In.	Box	Price
850-002	1/4	50	
850-005	1/2	25	
850-007	3/4	25	
850-010	1	15	
850-012	1-1/4	10	
850-015	1-1/2	10	
850-020	2	10	
850-025	2-1/2	5	
850-030	3	5	
850-040	4	5	
850-060	6	6	



GROOVED COUPLING ADAPTER
(groove x soc)

Part No.	Size-In.	Box	Price
833-012	1-1/4	10	
833-015	1-1/2	10	
833-020	2	10	
833-025	2-1/2	5	
833-030	3	5	
833-040	4	5	
833-060	6	5	
833-080F	8	1	
833-100F	10	1	
833-120F	12	1	



FLANGE ONE PIECE
(soc)

Part No.	Size-In.	Box	Price
851-005	1/2	25	
851-007	3/4	25	
851-010	1	15	
851-012	1-1/4	15	
851-015	1-1/2	20	
851-020	2	10	
851-025	2-1/2	10	
851-030	3	10	
851-040	4	5	
851-060	6	5	
851-080	8	2	
851-100F	10	1	
851-120F	12	1	



BLIND FLANGE

Part No.	Size-In.	Box	Price
853-005	1/2	25	
853-007	3/4	25	
853-010	1	15	
853-012	1-1/4	20	
853-015	1-1/2	15	
853-020	2	10	
853-025	2-1/2	10	
853-030	3	10	
853-040	4	8	
853-060	6	5	
853-080	8	5	
853-100	10	3	
853-120	12	2	



STEEL GROOVED COUPLING

Part No.	Size-In.	Box	Price
65LR3014	1-1/2	36	
65LR3020	2	30	
65LR3030	3	20	
65LR3040	4	18	
65LR3060	6	10	
65LR3080	8	1	
65LR3100	10	1	
65LR3120	12	1	

PVC SCHEDULE 80 NIPPLES

PVC Nipples furnished may be produced from extruded stock or from molded grade PVC compounds. Both processes provide quality products meeting ASTM requirements. Half size nipples not shown are priced the same as the next full size. For example: 7-1/2" is priced the same as 8". Contact us for price & availability of sizes, lengths, and / or configurations not shown.



To order PVC Sch. 80 Threaded Nipples, list the Diameter Code followed by the Length Code. For Example, in ordering 2" x 6" Nipples, the order number will read 887-060

PVC SCHEDULE 80 NIPPLE

Diameter		1/8"	1/4"	3/8"	1/2"	3/4"	1"	1 1/4"	1 1/2"	2"	2 1/2"	3"	4"	6"	8"	10"	12"
Diameter Code		879	880	881	882	883	884	885	886	887	888	889	890	892	893	894	895
Length	Length Code	Price	Price	Price	Price	Price	Price	Price	Price	Price	Price	Price	Price	Price	Price	Price	Price
Close	005																
1-1/2"	015																
2"	020																
2-1/2"	025																
3"	030																
3-1/2"	035																
4"	040																
4-1/2"	045																
5"	050																
5-1/2"	055																
6"	060																
7"	070																
8"	080																
9"	090																
10"	100																
11"	110																
12"	120																
13"	130																
14"	140																
15"	150																
16"	160																
17"	170																
18"	180																
19"	190																
20"	200																
22"	220																
24"	240																
30"	300																
36"	360																
42"	420																
48"	480																

1/8" Thru 2" diameter PVC Schedule 80 Nipples, up to 12" long, are packaged 25 per carton.
 TBE: Use part number shown - TOE: Add a "1" in front of part Number, e.g. 1883-060 - Plain: Add a "P" at the end of part number, e.g. 883-060P

LENGTH OF CLOSE & SHORT NIPPLES

Size	1/8"	1/4"	3/8"	1/2"	3/4"	1"	1 1/4"	1 1/2"	2"	2 1/2"	3"	4"	6"	8"	10"	12"
Close	3/4"	7/8"	1"	1-1/8"	1-3/8"	1-1/2"	1-5/8"	1-3/4"	2"	2-1/2"	2-5/8"	2-7/8"	3-3/4"	3-5/8"	4"	4-3/8"
Short	1-1/2"	1-1/2"	1-1/2"	1-1/2"	1-1/2"	2"	2"	2"	2-1/2"	3"	3"	3-1/2"	4-1/2"	4-1/2"	4-1/2"	5"

PVC SCHEDULE 80 GROOVED NIPPLES

PVC Nipples furnished may be fabricated from extruded stock or injection molded from PVC compounds. Both processes provide quality products meeting ASTM requirements.



GROOVE X PLAIN END

Part No.	Dia. x Length	Price
886-030PG	1-1/2" x 3"	
887-030PG	2" x 3"	
888-040PG	2-1/2" x 4"	
889-040PG	3" x 4"	
890-040PG	4" x 4"	
892-060PG	6" x 6"	
893-080PG	8" x 8"	
894-120PG	10" x 12"	



GROOVE X SOCKET

Part No.	Size-In.	Box	Price
833-012	1-1/4"	10	
833-015	1-1/2"	10	
833-020	2"	10	
833-025	2-1/2"	5	
833-030	3"	5	
833-040	4"	5	
833-060	6"	5	
833-080F	8"	1	
833-100F	10"	1	
833-120F	12"	1	



GROOVE X MIPT

Part No.	Dia. x Length	Price
887-030TG	2" x 3"	
888-040TG	2-1/2" x 4"	
889-040TG	3" x 4"	
890-040TG	4" x 4"	
892-060TG	6" x 6"	
893-080TG	8" x 8"	
894-120TG	10" x 12"	



GROOVE X FIPT

Part No.	Dia. x Length	Price
VG02FPT	2" x 3"	
VG025FPT	2-1/2" x 4"	
VG03FPT	3" x 4"	
VG04FPT	4" x 4"	
VG06FPT	6" x 6"	
VG08FPT	8" x 8"	
VG10FPT	10" x 12"	



GROOVE X INSERT

Part No.	Dia. x Length	Price
VG02IN	2" x 5"	
VG025IN	2-1/2" x 5"	
VG03IN	3" x 6"	
VG04IN	4" x 6"	
VG06IN	6" x 8"	
VG08IN	8" x 10"	
VG10IN	10" x 12"	



GROOVE X GROOVE

Part No.	Dia. x Length	Price
887-030GG	2" x 3"	
888-040GG	2-1/2" x 4"	
889-040GG	3" x 4"	
890-040GG	4" x 4"	
892-060GG	6" x 6"	
893-080GG	8" x 8"	
894-120GG	10" x 12"	

IPS® WELD-ON® LOW VOC PVC SOLVENT CEMENT

Part No.	Model No.	Size	Color	Use	Body	Setting	Price
10082	700™	1/4 Pint	Clear	Thru 4"	Regular	Fast	
10081		1/2 Pint					
10080		Pint					
10079		Quart					
10078		Gallon					
10101	705™	1/4 Pint	Gray	Thru 6"	Medium	Fast	
10098		1/2 Pint					
10094		Pint					
10090		Quart					
10086		Gallon					
10100	705™	1/4 Pint	Clear	Thru 6"	Medium	Fast	
10097		1/2 Pint					
10093		Pint					
10089		Quart					
10085		Gallon					
10123	711™	1/2 Pint	Gray	Thru 12"	Heavy	Medium	
10121		Pint					
10119		Quart					
10117		Gallon					
10150	717™	1/2 Pint	Clear	Thru 12"	Heavy	Medium	
10147		Pint					
10144		Quart					
10141		Gallon					
10151	717™	1/2 Pint	Gray	Thru 12"	Heavy	Medium	
10148		Pint					
10145		Quart					
10142		Gallon					
10159	719™	Pint	White	Thru 30"	Extra Heavy	Slow	
10157		Quart					
10155		Gallon					
10158	719™	Pint	Gray	Thru 30"	Extra Heavy	Slow	
10156		Quart					
13078		Gallon					
10850	725™ WET'R Dry	1/4 Pint	Aqua Blue	Thru 6"	Medium	Extra Fast	
10167		1/2 Pint					
10166		Pint					
10165		Quart					
10164		Gallon					
10990	737™ TURF'N AG	Pint	Blue Fades to Clear in Sunlight	Thru 8"	Medium	Very Fast	
10989		Quart					
10988		Gallon					
10283	795™ FLEX/RIGID FLEX/FLEX	1/4 Pint	Clear	Thru 6"	Medium	Fast	
10282		1/2 Pint					
10281		Pint					
10280		Quart					
10278		Gallon					



IPS® WELD-ON® MULTI-PURPOSE & TRANSITION CEMENT

Part No.	Model No.	Size	Color	Use	Body	Setting	Price
10260	790™	1/4 Pint	Clear	PVC to CPVC, Low Pressure ABS & Styrene Thru 6"	Medium	Fast	
10259		1/2 Pint					
10258		Pint					
10257		Quart					



IPS® WELD-ON® SPECIAL PURPOSE ADHESIVE

Part No.	Model No.	Size	Color	Description	Price
10813	810™ (A&B) Kit	4 Oz.	White	Two-component, high strength, reactive adhesive for joining, fabricating & repairing PVC & CPVC pipe & fittings. Bonds PVC & CPVC to dissimilar materials, such as metal, concrete, clay & others.	
10812		Pint			
10811		Quart			
10810		Gallon			



IPS® WELD-ON® PRIMERS & CLEANERS

Part No.	Model No.	Size	Color	Type	Use	Price
10216	P-68™	1/4 Pint	Purple	Primer	All Sizes PVC & CPVC	
10214		1/2 Pint				
10212		Pint				
10210		Quart				
10208		Gallon				
10215	P-68™	1/4 Pint	Clear	Primer	All Sizes PVC & CPVC	
10213		1/2 Pint				
10211		Pint				
10209		Quart				
10207		Gallon				
10226	P-70™	1/2 Pint	Clear	Primer	All Sizes PVC & CPVC, Cold Weather Applications	
10224		Pint				
10222		Quart				
10220	P-70™	Gallon	Purple	Primer		
10225		Pint				
10223		Quart				
10221	P-75™ WET'R DRY	Gallon	Aqua Blue	Primer	With 725™ Cement when Required Thru 6"	
10250		1/2 Pint				
10249		Pint				
10248		Quart				
10247	C-65™	Gallon	Clear	Cleaner	All Sizes PVC & CPVC ABS & Styrene	
10204		1/4 Pint				
10203		1/2 Pint				
10202		Pint				
10201		Quart				
10200	Gallon					



IPS® WELD-ON® EMPTY METAL CANS

Part No.	Model No.	Can Size	Neck Size / Style	Applicator Options	Price
10015	MT-654	Pint	1-3/4"	DP-75, DP-150	
10014	MT-653	Quart	Triple Tight Paint Lid	3020	
10012	MT-651	Quart	1-3/4"	DQ-75, DQ-150	
10010	MT-648	Gallon	2-7/8"	4020,7020	



IPS® WELD-ON® APPLICATORS

Part No.	Model No.	Type	Size / Pipe Size	Can Options	Price
10004	DP-75	Dauber	3/4"/up to 1-1/2" Dia.	MT-654	
10003	DP-100	Dauber	1"/up to 1-1/2" Dia.	MT-654 Cleaners Only	
10005	DP-150	Dauber	1-1/2"/up to 3" Dia.	MT-654	
12429	DQ-75	Dauber	3/4"/up to 1-1/2" Dia.	MT-651	
10006	DQ-150	Dauber	1-1/2"/up to 3" Dia.	MT-651	
10832	CM-75	Dauber	3/4"/up to 1-1/2" Dia.	MT-654, MT-651	
10833	CM-150	Dauber	1-1/2"/up to 3" Dia.	MT-654, MT-651	
10007	3020	Roller	3" long / 3" - 6" Dia.	MT-653	
10008	7020	Roller	7" long / 6" Dia. & Up	MT-648	
10009	4020	Swab	4" long / 6" Dia. & Up	MT-648	



IPS® WELD-ON® SUPER SWAB

Part No.	Description	Price
14111	Super Swab	
14112	Replacement Swabs	



IPS® WELD-ON® TWO CAN TOTE CARRIER

Part No.	Description	Price
12891	Can Tote Carrier	



1. ELECTRICAL 2. PUMP Acc. 3. HOSE, PE Pipe & Acc. 4. IPS PIP Pipe & Acc. 5. SURFACE 6. SPRINKLERS 7. TRAVELER & WHEEL MOVE 8. PIVOT 9. TURF 10. LOW VOLUME 11. FILTERS 12. INJECTION 13. HARDWARE INDEX

PIPE THREAD SEALANT

WHITE SEAL THREAD SEALANT

Part No.	Size	Description	Price
80200	2 Oz.	A white grit-free, extreme duty pipe joint compound with a special blend of homogenized Teflon® particles & non-toxic oils for sealing and lubricating all metal and plastic threaded piping systems.	
87725	1/4 Pint		
87730	1/2 Pint		
87735	Pint		
87740	Quart		



THREAD SEAL TAPE WITH TEFLON®

Part No.	Size	Description	Price
TF03520	1/2" x 520"	Quality Teflon® Tape - pipe joint compound in tape form for sealing & lubricating all metal and plastic fittings.	
TF04520	3/4" x 520"		
TF05520	1" x 520"		



LUBRICANTS

SEAL LUBE GASKET LUBRICANT: MILKY

Part No.	Size	Description	Price
87705	Pint	Primes & lubricates slip-on or "O" ring type joints with rubber or synthetic rubber gaskets.	
87710	Quart		
87715	Gallon		



EZ FLUSH PIPE LUBRICANT: BLUE

Part No.	Size	Description	Price
87717	Pint	EZ Flush is designed for lubricating slip-on or "O" Ring type joints without harming rubber or plastic gaskets. For joining all metal and plastic gasketed pipe. Will not coagulate and will not promote turbidity. No taste or odor is transferred to fluids in piping system. Non-toxic and non-corrosive. Temperature use range: 0° to 150°F. Flushes completely out.	
87718	Quart		
87719	Gallon		
87721	5 Gallon		



HAND CLEANER

HERCULES FOR HANDS™ BIG PRE-MOISTENED HAND CLEANING TOWELS

Great for working hands: Irrigation, plumbing & heating, auto & truck repair, farms & gardens, factories & machinery, painting & more. It is anti-bacterial & removes the toughest soils, stains, grease, paint, tar, PVC cement, adhesives, ink, sealants, sticky dirt & more. Contains: premium skin-condition aloe, lanolin & vitamin E. No harsh solvents or chemicals.

Part No.	Description	Price
45-333	Dispenser Contains 70 Pre-moistened 12" x 10" Towels	



CUTTING TOOLS AND SAWS

KWIKCUT CUTTER WITH STAINLESS BLADE

Complete Cutter				Stainless Blade Only		
Part No.	Cuts Up To	Handle	Price	Part No.	Description	Price
T100YSS	1-1/4" O.D.	Black		BT100SS	Blade Only	
T135YSS	1-5/8" O.D.	Black		BT135SS	Blade Only	
T135SS	1-5/8" O.D.	Orange		BT135SS	Blade Only	
SS200	1-7/8" O.D.	Black		SSB200	Blade Only	



HAND SAWS & REPLACEMENT BLADES

Part No.	Blade Length	Description	Price
4333	18"	Journeyman Saw with Aluminum Handle	
4333-B	18"	Replacement Blade for Journeyman Saw	
4331	13"	Mighty Mite Saw with Aluminum Handle	
4331-B	13"	Replacement Blade for Mighty Mite Saw	
4012	12-1/2"	Lenox® Hackmaster® Professional Hacksaw	
V224HE	12-1/2"	Lenox® Hacksaw Blade - 24 TPI - 10 Pack	
224HE	12-1/2"	Lenox® Hacksaw Blade - 24 TPI - 100 Piece Dispenser	
HSF120	12"	Lenox® Plastic Pipe Hand Saw	
HSB120	12"	Lenox® 12" Blade only for HSF120	



CABLE SAW

Part No.	Model No.	Description	Price
12739	CST-36	36" Cable Saw for Cutting Pipe Thru 8" Dia.	



DEBURRING TOOL

Part No.	Model No.	Description	Price
12079	DEB-2	Tool For 1/2" Thru 2" PVC, CPVC, ABS, PE, PB	



INTRO
 1. ELECTRICAL
 2. PUMP Acc.
 3. HOSE, PE Pipe & Acc.
 4. IPS, PIP Pipe & Acc.
 5. SURFACE
 6. SPRINKLERS
 7. TRAVELER & WHEEL MOVE
 8. PIVOT
 9. TURN
 10. LOW VOLUME
 11. FILTERS
 12. INJECTION
 13. HARDWARE
 INDEX

IPS EPOXY FITTINGS

PIERCE IPS WELD-ON COUPLER

Size	Part No.	Price
2"	P1001-11	
2-1/2"	P1001-12	
3"	P1001-13	
4"	P1001-14	
5"	P1001-15	
6"	P1001-16	
8"	P1001-17	
10"	P1001-18	
12"	P1001-19	



TRAVIS IPS WELD-ON COUPLER

Size	Part No.	Price
4"	IPS-SC-4	
5"	IPS-SC-5	
6"	IPS-SC-6	
8"	IPS-SC-8	
10"	IPS-SC-10	
12"	IPS-SC-12	

PIERCE IPS FLANGED ADAPTER

Size	Part No.	Price
3"	P1143-03	
4"	P1143-04	
6"	P1143-06	
8"	P1143-07	
10"	P1143-08	
12"	P1143-09	



TRAVIS IPS FLANGED ADAPTER

Size	Part No.	Price
4"	IPS-4004FL	
5"	IPS-5005FL	
6"	IPS-6006FL	
8"	IPS-8008FL	
10"	IPS-1010FL	
12"	IPS-1212FL	

PIERCE IPS REPAIR COUPLER

Size	Part No.	Price
2"	P1576-01	
2-1/2"	P1576-02	
3"	P1576-03	
4"	P1578-01	
6"	P1578-02	
8"	P1578-03	
10"	P1578-04	
12"	P1579-01	



TRAVIS IPS REPAIR COUPLER

Size	Part No.	Price
4"	IPS-RC4	
5"	IPS-RC5	
6"	IPS-RC6	
8"	IPS-RC8	
10"	IPS-RC10	
12"	IPS-RC12	

PIERCE IPS CROSS

Size	Part No.	Price
2-1/2"	P1494-01	
3"	P1494-04	
4"	P1495-01	
6"	P1497-09	
8"	P1497-12	
10"	P1501-01	
12"	P1496-10	



TRAVIS IPS CROSS

Size	Part No.	Price
4"	IPSX4	
5"	IPSX5	
6"	IPSX6	
8"	IPSX8	
10"	IPSX10	
12"	IPSX12	

PIERCE IPS 90° ELBOW

Size	Part No.	Price
2"	P1552-01	
2-1/2"	P1552-02	
3"	P1552-03	
4"	P1552-04	
6"	P1554-01	
8"	P1554-02	
10"	P1554-03	
12"	P1554-04	



TRAVIS IPS 90° ELBOW

Size	Part No.	Price
4"	IPS-FE-4	
5"	IPS-FE-5	
6"	IPS-FE-6	
8"	IPS-FE-8	
10"	IPS-FE-10	
12"	IPS-FE-12	

Add G after part number for galvanized (same price) example - IPS-FE-4-G

PIERCE IPS 45° ELBOW

Size	Part No.	Price
2"	P1553-01	
2-1/2"	P1553-02	
3"	P1553-03	
4"	P1553-04	
6"	P1555-01	
8"	P1555-02	
10"	P1555-03	
12"	P1555-04	

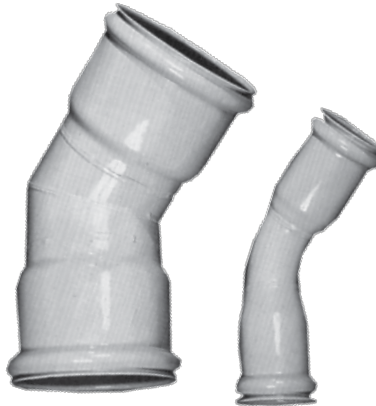

TRAVIS IPS 45° ELBOW

Size	Part No.	Price
4"	IPS-FE-4-45	
5"	IPS-FE-5-45	
6"	IPS-FE-6-45	
8"	IPS-FE-8-45	
10"	IPS-FE-10-45	
12"	IPS-FE-12-45	

Add G after part number for galvanized (same price) example - IPS-FE-4-45-G

PIERCE IPS 22 1/2° ELBOW

Size	Part No.	Price
2"	P1564-01	
2-1/2"	P1564-02	
3"	P1564-03	
4"	P1564-04	
6"	P1564-05	
8"	P1564-06	
10"	P1564-07	
12"	P1564-08	



TRAVIS IPS 22 1/2° ELBOW

Size	Part No.	Price
4"	IPS-FE-4-22	
5"	IPS-FE-5-22	
6"	IPS-FE-6-22	
8"	IPS-FE-8-22	
10"	IPS-FE-10-22	
12"	IPS-FE-12-22	

Add G after part number for galvanized (same price) example - IPS-FE-4-22-G

INTRO
1. ELECTRICAL
2. PUMP ACC.
3. HOSE, PE PIPE & ACC.
4. IPS PIP PIPE & ACC.
5. SURFACE
6. SPRINKLERS
7. TRAVELER & WHEEL MOVE
8. PIVOT
9. TURN
10. LOW VOLUME
11. FILTERS
12. INJECTION
13. HARDWARE
INDEX

IPS EPOXY FITTINGS

PIERCE IPS STRAIGHT TEE

Size	Part No.	Price
2"	P1459-01	
2-1/2"	P1457-03	
3"	P1457-06	
4"	P1457-09	
6"	P1459-07	
8"	P1459-13	
10"	P1455-02	
12"	P1460-10	



TRAVIS IPS STRAIGHT TEE

Size	Part No.	Price
4"	IPS-FT-444	
5"	IPS-FT-555	
6"	IPS-FT-666	
8"	IPS-FT-888	
10"	IPS-FT-101010	
12"	IPS-FT-121212	

Add G after part number for galvanized (same price) example - IPS-FT-444-G

PIERCE IPS REDUCING TEE

Size	Part No.	Price
2" x 2" x 3"	P1462-02	
3" x 2" x 2"	P1480-03	
3" x 2" x 3"	P1480-05	
3" x 3" x 2"	P1457-04	
3" x 3" x 4"	P1462-10	
4" x 2" x 2"	P1477-01	
4" x 2" x 4"	P1480-11	
4" x 3" x 3"	P1480-15	
4" x 3" x 4"	P1480-16	
4" x 4" x 2"	P1456-01	
4" x 4" x 3"	P1457-08	
4" x 4" x 6"	P1462-15	
6" x 3" x 3"	P1485-12	
6" x 3" x 6"	P1485-15	
6" x 4" x 4"	P1480-19	
6" x 6" x 2"	P1456-02	
6" x 6" x 3"	P1459-04	
6" x 6" x 4"	P1459-05	
6" x 6" x 8"	P1462-18	
8" x 4" x 4"	P1485-18	
8" x 4" x 8"	P1485-21	
8" x 6" x 6"	P1481-05	
8" x 8" x 3"	P1459-09	
8" x 8" x 4"	P1459-10	
8" x 8" x 6"	P1459-12	
8" x 8" x 10"	P1462-19	
10" x 6" x 6"	P1485-30	
10" x 6" x 10"	P1486-05	
10" x 8" x 8"	P1482-02	
10" x 8" x 10"	P1482-03	
10" x 10" x 2"	P1458-02	
10" x 10" x 3"	P1459-15	
10" x 10" x 4"	P1459-16	
10" x 10" x 6"	P1459-18	
10" x 10" x 8"	P1455-01	
10" x 10" x 12"	P1462-20	
12" x 12" x 4"	P1460-05	
12" x 12" x 6"	P1460-07	
12" x 12" x 8"	P1460-08	
12" x 12" x 10"	P1460-09	

Note: 2-1/2" Reducing Tees are also available & will be quoted upon request.



TRAVIS IPS REDUCING TEE

Size	Part No.	Price
2" x 2" x 3"	IPS-RT-223	
3" x 2" x 2"	IPS-RT-322	
3" x 2" x 3"	IPS-RT-323	
3" x 3" x 2"	IPS-RT-332	
3" x 3" x 4"	IPS-RT-334	
4" x 2" x 2"	IPS-RT-422	
4" x 2" x 4"	IPS-RT-424	
4" x 3" x 3"	IPS-RT-433	
4" x 3" x 4"	IPS-RT-434	
4" x 4" x 2"	IPS-RT-442	
4" x 4" x 3"	IPS-RT-443	
4" x 4" x 6"	IPS-RT-446	
6" x 3" x 3"	IPS-RT-633	
6" x 3" x 6"	IPS-RT-636	
6" x 4" x 4"	IPS-RT-644	
6" x 6" x 2"	IPS-RT-662	
6" x 6" x 3"	IPS-RT-663	
6" x 6" x 4"	IPS-RT-664	
6" x 6" x 8"	IPS-RT-668	
8" x 4" x 4"	IPS-RT-844	
8" x 4" x 8"	IPS-RT-848	
8" x 6" x 6"	IPS-RT-866	
8" x 8" x 3"	IPS-RT-883	
8" x 8" x 4"	IPS-RT-884	
8" x 8" x 6"	IPS-RT-886	
8" x 8" x 10"	IPS-RT-8810	
10" x 6" x 6"	IPS-RT-1066	
10" x 6" x 10"	IPS-RT-10610	
10" x 8" x 8"	IPS-RT-1088	
10" x 8" x 10"	IPS-RT-10810	
10" x 10" x 2"	IPS-RT-10102	
10" x 10" x 3"	IPS-RT-10103	
10" x 10" x 4"	IPS-RT-10104	
10" x 10" x 6"	IPS-RT-10106	
10" x 10" x 8"	IPS-RT-10108	
10" x 10" x 12"	IPS-RT-101012	
12" x 12" x 4"	IPS-RT-12124	
12" x 12" x 6"	IPS-RT-12126	
12" x 12" x 8"	IPS-RT-12128	
12" x 12" x 10"	IPS-RT-121210	

Add G after part number for galvanized (same price) example - IPS-RT-G-443



**PIERCE
IPS SERVICE TEE WITH FIPT OUTLET**

Size	Part No.	Price
2" x 1"	P1354-01	
2" x 1-1/4"	P1354-02	
2" x 1-1/2"	P1355-01	
2" x 2"	P1355-02	
2-1/2" x 1"	P1356-01	
2-1/2" x 1-1/4"	P1356-02	
2-1/2" x 1-1/2"	P1356-03	
2-1/2" x 2"	P1357-01	
2-1/2" x 2-1/2"	P1357-02	
3" x 1"	P1358-01	
3" x 1-1/4"	P1358-02	
3" x 1-1/2"	P1358-03	
3" x 2"	P1359-01	
3" x 2-1/2"	P1359-02	
3" x 3"	P1359-03	
4" x 1"	P1360-01	
4" x 1-1/4"	P1360-02	
4" x 1-1/2"	P1360-03	
4" x 2"	P1360-04	
4" x 2-1/2"	P1361-01	
4" x 3"	P1361-02	
4" x 4"	P1361-03	
6" x 1"	P1364-01	
6" x 1-1/4"	P1364-02	
6" x 1-1/2"	P1364-03	
6" x 2"	P1364-04	
6" x 2-1/2"	P1365-01	
6" x 3"	P1365-02	
6" x 4"	P1365-03	
6" x 6"	P1365-05	
8" x 1-1/2"	P1367-02	
8" x 2"	P1367-03	
8" x 3"	P1368-02	
8" x 4"	P1368-03	
10" x 1-1/2"	P1370-02	
10" x 2"	P1370-03	
10" x 2-1/2"	P1371-01	
10" x 3"	P1372-01	
10" x 4"	P1372-02	
12" x 1-1/2"	P1374-02	
12" x 2"	P1374-03	
12" x 2-1/2"	P1375-01	
12" x 3"	P1375-02	
12" x 4"	P1376-01	



**TRAVIS
IPS SERVICE TEE WITH FIPT OUTLET**

Size	Part No.	Price
4" x 3"	IPS-43FT-FF	
5" x 3"	IPS-53FT-FF	
6" x 3"	IPS-63FT-FF	
8" x 3"	IPS-83FT-FF	
10" x 3"	IPS-103FT-FF	
12" x 3"	IPS-123FT-FF	
4" x 4"	IPS-44FT-FF	
5" x 4"	IPS-54FT-FF	
6" x 4"	IPS-64FT-FF	
8" x 4"	IPS-84FT-FF	
10" x 4"	IPS-104FT-FF	
12" x 4"	IPS-124FT-FF	

Note: 6" and above available with 6" thread. Add price to the list price of appropriate 4" FIPT outlet.

**TRAVIS
IPS SERVICE TEE WITH MIPT OUTLET**

Size	Part No.	Price
4" x 3"	IPS-43MT-FF	
5" x 3"	IPS-53MT-FF	
6" x 3"	IPS-63MT-FF	
8" x 3"	IPS-83MT-FF	
10" x 3"	IPS-103MT-FF	
12" x 3"	IPS-123MT-FF	
4" x 4"	IPS-44MT-FF	
5" x 4"	IPS-54MT-FF	
6" x 4"	IPS-64MT-FF	
8" x 4"	IPS-84MT-FF	
10" x 4"	IPS-104MT-FF	
12" x 4"	IPS-124MT-FF	

Note: 6" and above available with 6" thread. Add price to the list price of appropriate 4" MIPT outlet.

INTRO
1. ELECTRICAL
2. PUMP ACC.
3. HOSE, PE PIPE & ACC.
4. IPS PIP PIPE & ACC.
5. SURFACE
6. SPRINKLERS
7. TRAVELER & WHEEL MOVE
8. PIVOT
9. TURN
10. LOW VOLUME
11. FILTERS
12. INJECTION
13. HARDWARE
INDEX



**PIERCE
IPS TEE RISER (FEMALE X FEMALE)**

Size	Part No.	Price
4" x 4" x 4" x 30"	P1220-04	
4" x 4" x 4" x 36"	P1220-05	
4" x 4" x 4" x 42"	P1220-06	
6" x 6" x 4" x 30"	P1223-04	
6" x 6" x 4" x 36"	P1223-05	
6" x 6" x 4" x 42"	P1223-06	
8" x 8" x 4" x 30"	P1226-04	
8" x 8" x 4" x 36"	P1226-05	
8" x 8" x 4" x 42"	P1226-06	
10" x 10" x 4" x 30"	P1229-04	
10" x 10" x 4" x 36"	P1229-05	
10" x 10" x 4" x 42"	P1229-06	
12" x 12" x 4" x 30"	P1232-04	
12" x 12" x 4" x 36"	P1232-05	
12" x 12" x 4" x 42"	P1232-06	
6" x 6" x 6" x 30"	P1224-04	
6" x 6" x 6" x 36"	P1224-05	
6" x 6" x 6" x 42"	P1224-06	
8" x 8" x 6" x 30"	P1227-04	
8" x 8" x 6" x 36"	P1227-05	
8" x 8" x 6" x 42"	P1227-06	
10" x 10" x 6" x 30"	P1230-04	
10" x 10" x 6" x 36"	P1230-05	
10" x 10" x 6" x 42"	P1230-06	
12" x 12" x 6" x 30"	P1233-04	
12" x 12" x 6" x 36"	P1233-05	
12" x 12" x 6" x 42"	P1233-06	
10" x 10" x 8" x 30"	P1231-04	
10" x 10" x 8" x 36"	P1231-05	
10" x 10" x 8" x 42"	P1231-06	
12" x 12" x 8" x 42"	P1234-06	

**TRAVIS
IPS TEE RISER (FEMALE X FEMALE)**

Size	Part No.	Price
4" x 4" x 4" x 30"	IPS-4430-FF	
4" x 4" x 4" x 36"	IPS-4436-FF	
4" x 4" x 4" x 42"	IPS-4442-FF	
6" x 6" x 4" x 30"	IPS-6430-FF	
6" x 6" x 4" x 36"	IPS-6436-FF	
6" x 6" x 4" x 42"	IPS-6442-FF	
8" x 8" x 4" x 30"	IPS-8430-FF	
8" x 8" x 4" x 36"	IPS-8436-FF	
8" x 8" x 4" x 42"	IPS-8442-FF	
10" x 10" x 4" x 30"	IPS-10430-FF	
10" x 10" x 4" x 36"	IPS-10436-FF	
10" x 10" x 4" x 42"	IPS-10442-FF	
12" x 12" x 4" x 30"	IPS-12430-FF	
12" x 12" x 4" x 36"	IPS-12436-FF	
12" x 12" x 4" x 42"	IPS-12442-FF	
6" x 6" x 6" x 30"	IPS-6630-FF	
6" x 6" x 6" x 36"	IPS-6636-FF	
6" x 6" x 6" x 42"	IPS-6642-FF	
8" x 8" x 6" x 30"	IPS-8630-FF	
8" x 8" x 6" x 36"	IPS-8636-FF	
8" x 8" x 6" x 42"	IPS-8642-FF	
10" x 10" x 6" x 30"	IPS-10630-FF	
10" x 10" x 6" x 36"	IPS-10636-FF	
10" x 10" x 6" x 42"	IPS-10642-FF	
12" x 12" x 6" x 30"	IPS-12630-FF	
12" x 12" x 6" x 36"	IPS-12636-FF	
12" x 12" x 6" x 42"	IPS-12642-FF	
10" x 10" x 8" x 30"	IPS-10830-FF	
10" x 10" x 8" x 36"	IPS-10836-FF	
10" x 10" x 8" x 42"	IPS-10842-FF	
12" x 12" x 8" x 42"	IPS-12842-FF	



**PIERCE
IPS TEE RISER (MALE X FEMALE)**

Size	Part No.	Price
4" x 4" x 4" x 30"	P1236-04	
4" x 4" x 4" x 36"	P1236-05	
4" x 4" x 4" x 42"	P1236-06	
6" x 6" x 4" x 30"	P1238-04	
6" x 6" x 4" x 36"	P1238-05	
6" x 6" x 4" x 42"	P1238-06	
8" x 8" x 4" x 30"	P1240-04	
8" x 8" x 4" x 36"	P1240-05	
8" x 8" x 4" x 42"	P1240-06	
10" x 10" x 4" x 30"	P1243-04	
10" x 10" x 4" x 36"	P1243-05	
10" x 10" x 4" x 42"	P1243-06	
12" x 12" x 4" x 30"	P1246-04	
12" x 12" x 4" x 36"	P1246-05	
12" x 12" x 4" x 42"	P1246-06	
6" x 6" x 6" x 30"	P1239-04	
6" x 6" x 6" x 36"	P1239-05	
6" x 6" x 6" x 42"	P1239-06	
8" x 8" x 6" x 30"	P1241-04	
8" x 8" x 6" x 36"	P1241-05	
8" x 8" x 6" x 42"	P1241-06	
10" x 10" x 6" x 30"	P1244-04	
10" x 10" x 6" x 36"	P1244-05	
10" x 10" x 6" x 42"	P1244-06	
12" x 12" x 6" x 30"	P1247-04	
12" x 12" x 6" x 36"	P1247-05	
12" x 12" x 6" x 42"	P1247-06	
10" x 10" x 8" x 30"	P1245-04	
10" x 10" x 8" x 36"	P1245-05	
10" x 10" x 8" x 42"	P1245-06	
12" x 12" x 8" x 42"	P1248-06	

**TRAVIS
IPS TEE RISER (MALE X FEMALE)**

Size	Part No.	Price
4" x 4" x 4" x 30"	IPS-4430-MF	
4" x 4" x 4" x 36"	IPS-4436-MF	
4" x 4" x 4" x 42"	IPS-4442-MF	
6" x 6" x 4" x 30"	IPS-6430-MF	
6" x 6" x 4" x 36"	IPS-6436-MF	
6" x 6" x 4" x 42"	IPS-6442-MF	
8" x 8" x 4" x 30"	IPS-8430-MF	
8" x 8" x 4" x 36"	IPS-8436-MF	
8" x 8" x 4" x 42"	IPS-8442-MF	
10" x 10" x 4" x 30"	IPS-10430-MF	
10" x 10" x 4" x 36"	IPS-10436-MF	
10" x 10" x 4" x 42"	IPS-10442-MF	
12" x 12" x 4" x 30"	IPS-12430-MF	
12" x 12" x 4" x 36"	IPS-12436-MF	
12" x 12" x 4" x 42"	IPS-12442-MF	
6" x 6" x 6" x 30"	IPS-6630-MF	
6" x 6" x 6" x 36"	IPS-6636-MF	
6" x 6" x 6" x 42"	IPS-6642-MF	
8" x 8" x 6" x 30"	IPS-8630-MF	
8" x 8" x 6" x 36"	IPS-8636-MF	
8" x 8" x 6" x 42"	IPS-8642-MF	
10" x 10" x 6" x 30"	IPS-10630-MF	
10" x 10" x 6" x 36"	IPS-10636-MF	
10" x 10" x 6" x 42"	IPS-10642-MF	
12" x 12" x 6" x 30"	IPS-12630-MF	
12" x 12" x 6" x 36"	IPS-12636-MF	
12" x 12" x 6" x 42"	IPS-12642-MF	
10" x 10" x 8" x 30"	IPS-10830-MF	
10" x 10" x 8" x 36"	IPS-10836-MF	
10" x 10" x 8" x 42"	IPS-10842-MF	
12" x 12" x 8" x 42"	IPS-12842-MF	

INTRO
 1. ELECTRICAL
 2. PUMP ACC.
 3. HOSE, PE PIPE & ACC.
 4. IPS PIP PIPE & ACC.
 5. SURFACE
 6. SPRINKLERS
 7. TRAVELER & WHEEL MOVE
 8. PIVOT
 9. TURF
 10. LOW VOLUME
 11. FILTERS
 12. INJECTION
 13. HARDWARE
 INDEX



PIERCE IPS CAP RISERS

Size	Part No.	Price
4" x 4" x 30"	P1252-04	
4" x 4" x 36"	P1252-05	
4" x 4" x 42"	P1252-06	
6" x 4" x 30"	P1254-04	
6" x 4" x 36"	P1254-05	
6" x 4" x 42"	P1254-06	
8" x 4" x 30"	P1256-04	
8" x 4" x 36"	P1256-05	
8" x 4" x 42"	P1256-06	
10" x 4" x 30"	P1259-04	
10" x 4" x 36"	P1259-05	
10" x 4" x 42"	P1259-06	
12" x 4" x 30"	P1262-04	
12" x 4" x 36"	P1262-05	
12" x 4" x 42"	P1262-06	
6" x 6" x 30"	P1255-04	
6" x 6" x 36"	P1255-05	
6" x 6" x 42"	P1255-06	
8" x 6" x 30"	P1257-04	
8" x 6" x 36"	P1257-05	
8" x 6" x 42"	P1257-06	
10" x 6" x 30"	P1260-04	
10" x 6" x 36"	P1260-05	
10" x 6" x 42"	P1260-06	
12" x 6" x 30"	P1263-04	
12" x 6" x 36"	P1263-05	
12" x 6" x 42"	P1263-06	
10" x 8" x 30"	P1261-04	
10" x 8" x 36"	P1261-05	
10" x 8" x 42"	P1261-06	
12" x 8" x 42"	P1264-06	

TRAVIS IPS CAP RISERS

Size	Part No.	Price
4" x 4" x 30"	IPS-4430-FC	
4" x 4" x 36"	IPS-4436-FC	
4" x 4" x 42"	IPS-4442-FC	
6" x 4" x 30"	IPS-6430-FC	
6" x 4" x 36"	IPS-6436-FC	
6" x 4" x 42"	IPS-6442-FC	
8" x 4" x 30"	IPS-8430-FC	
8" x 4" x 36"	IPS-8436-FC	
8" x 4" x 42"	IPS-8442-FC	
10" x 4" x 30"	IPS-10430-FC	
10" x 4" x 36"	IPS-10436-FC	
10" x 4" x 42"	IPS-10442-FC	
12" x 4" x 30"	IPS-12430-FC	
12" x 4" x 36"	IPS-12436-FC	
12" x 4" x 42"	IPS-12442-FC	
6" x 6" x 30"	IPS-6630-FC	
6" x 6" x 36"	IPS-6636-FC	
6" x 6" x 42"	IPS-6642-FC	
8" x 6" x 30"	IPS-8630-FC	
8" x 6" x 36"	IPS-8636-FC	
8" x 6" x 42"	IPS-8642-FC	
10" x 6" x 30"	IPS-10630-FC	
10" x 6" x 36"	IPS-10636-FC	
10" x 6" x 42"	IPS-10642-FC	
12" x 6" x 30"	IPS-12630-FC	
12" x 6" x 36"	IPS-12636-FC	
12" x 6" x 42"	IPS-12642-FC	
10" x 8" x 30"	IPS-10830-FC	
10" x 8" x 36"	IPS-10836-FC	
10" x 8" x 42"	IPS-10842-FC	
12" x 8" x 42"	IPS-12842-FC	

IPS EPOXY FITTINGS

PIERCE ELBOW OPTION FOR TEE & CAP RISER

Size	Part No.	Price
2" MIPT SWEEP	P2MIPT-SE	
3" MIPT SWEEP	P3MIPT-SE	
4" MIPT SWEEP	P4MIPT-SE	
2" FIPT SWEEP	P2FIPT-SE	
3" FIPT SWEEP	P3FIPT-SE	
4" FIPT SWEEP	P4FIPT-SE	



TRAVIS ELBOW OPTION FOR TEE & CAP RISER

Size	Part No.	Price
2" MIPT SWEEP	IPS-200MIPT-SE	
3" MIPT SWEEP	IPS-300MIPT-SE	
4" MIPT SWEEP	IPS-400MIPT-SE	
2" FIPT SWEEP	IPS-200FIPT-SE	
3" FIPT SWEEP	IPS-300FIPT-SE	
4" FIPT SWEEP	IPS-400FIPT-SE	

PIERCE IPS REDUCER (FEMALE X FEMALE)

IPS Bell	IPS Bell	Part No.	Price
2-1/2"	2"	P1527-01	
3"	2"	P1527-02	
3"	2-1/2"	P1527-03	
4"	2"	P1527-04	
4"	2-1/2"	P1527-05	
4"	3"	P1527-06	
6"	2"	P1528-04	
6"	2-1/2"	P1528-05	
6"	3"	P1528-06	
6"	4"	P1527-08	
8"	4"	P1528-07	
8"	6"	P1527-10	
10"	4"	P1529-04	
10"	6"	P1528-09	
10"	8"	P1527-11	
12"	6"	P1529-06	
12"	8"	P1528-10	
12"	10"	P1527-12	



TRAVIS IPS REDUCER (FEMALE X FEMALE)

Size	Part No.	Price
5" x 4"	IPS-R54	
6" x 3"	IPS-R63	
6" x 4"	IPS-R64	
6" x 5"	IPS-R65	
8" x 6"	IPS-R86	
10" x 6"	IPS-R106	
10" x 8"	IPS-R108	
12" x 8"	IPS-R128	
12" x 10"	IPS-R1210	

PIERCE IPS REDUCER (MALE X FEMALE)

IPS Male	IPS Bell	Part No.	Price
2-1/2"	2"	P1532-01	
3"	2-1/2"	P1532-02	
3"	2"	P1532-03	
4"	2"	P1532-04	
4"	2-1/2"	P1532-05	
4"	3"	P1532-06	
6"	2"	P1533-04	
6"	2-1/2"	P1533-05	
6"	3"	P1533-06	
6"	4"	P1532-08	
8"	3"	P1534-03	
8"	4"	P1533-07	
8"	6"	P1532-10	
10"	4"	P1534-04	
10"	6"	P1533-09	
10"	8"	P1532-11	
12"	6"	P1534-06	
12"	8"	P1533-10	
12"	10"	P1532-12	



TRAVIS IPS REDUCER (MALE X FEMALE)

Size	Part No.	Price
5" x 4"	IPS-R54MXF	
6" x 3"	IPS-R63MXF	
6" x 4"	IPS-R64MXF	
6" x 5"	IPS-R65MXF	
8" x 6"	IPS-R86MXF	
10" x 6"	IPS-R106MXF	
10" x 8"	IPS-R108MXF	
12" x 8"	IPS-R128MXF	
12" x 10"	IPS-R1210MXF	

IPS EPOXY FITTINGS

PIERCE IPS END CAP

Size	Part No.	Price
2"	P1588-01	
2-1/2"	P1588-02	
3"	P1588-03	
4"	P1588-04	
6"	P1588-06	
8"	P1588-07	
10"	P1588-08	
12"	P1588-09	



TRAVIS IPS END CAP

Size	Part No.	Price
4"	IPS-FEP-4	
5"	IPS-FEP-5	
6"	IPS-FEP-6	
8"	IPS-FEP-8	
10"	IPS-FEP-10	
12"	IPS-FEP-12	

PIERCE IPS END CAP WITH FIPT OUTLET

Size	Part No.	Price
2" x 1-1/2"	P1424-01	
2"-1/2" x 1-1/2"	P1425-03	
3" x 1-1/2"	P1427-03	
4" x 1-1/2"	P1429-03	
4" x 2"	P1429-04	



TRAVIS IPS END CAP WITH FIPT OUTLET

Size	Part No.	Price
4" x 1-1/2"	IPS-FEP-4-150	
4" x 2"	IPS-FEP-4-200	
6" x 1-1/2"	IPS-FEP-6-150	
6" x 2"	IPS-FEP-6-200	
8" x 2"	IPS-FEP-8-200	

PIERCE IPS END PLUG

Size	Part No.	Price
2-1/2"	P1584-02	
3"	P1584-03	
4"	P1584-04	
6"	P1584-06	
8"	P1584-07	
10"	P1584-08	
12"	P1584-09	

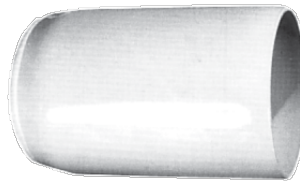

TRAVIS IPS END PLUG

Size	Part No.	Price
4"	IPS-EP-4	
5"	IPS-EP-5	
6"	IPS-EP-6	
8"	IPS-EP-8	
10"	IPS-EP-10	
12"	IPS-EP-12	

PIERCE IPS COMPRESSION GASKET

Size	Part No.	Price
2"	P1600-01	
2-1/2"	P1601-01	
3"	P1602-01	
4"	P1603-01	
5"	P1604-01	
6"	P1605-01	
8"	P1606-01	
10"	P1607-01	
12"	P1608-01	



TRAVIS IPS COMPRESSION GASKET

Size	Part No.	Price
4"	IPS-CG-4	
5"	IPS-CG-5	
6"	IPS-CG-6	
8"	IPS-CG-8	
10"	IPS-CG-10	
12"	IPS-CG-12	

Travis Old Style with Plastic Snap Ring is Still Available. Call for Pricing.

PIP EPOXY FITTINGS

PIERCE PIP WELD-ON COUPLER

Size	Part No.	Price
4"	P1003-11	
6"	P1003-12	
8"	P1003-13	
10"	P1003-14	
12"	P1003-15	
15"	P1133-01	
18"	P1006-03	



TRAVIS PIP WELD-ON COUPLER

Size	Part No.	Price
6"	PIP-SC-6	
8"	PIP-SC-8	
10"	PIP-SC-10	
12"	PIP-SC-12	
15"	PIP-SC-15	

PIERCE PIP FLANGED ADAPTER

Size	Part No.	Price
4"	P1144-01	
6"	P1144-02	
8"	P1144-03	
10"	P1144-04	
12"	P1144-05	
15"	P1145-01	
18"	P1146-01	



TRAVIS PIP FLANGED ADAPTER

Size	Part No.	Price
6"	PIP-6006FL	
8"	PIP-8008FL	
10"	PIP-1010FL	
12"	PIP-1212FL	
15"	PIP-1515FL	

PIERCE PIP REPAIR COUPLER

Size	Part No.	Price
6"	P1581-02	
8"	P1581-03	
10"	P1581-04	
12"	P1581-05	
15"	P1582-01	



TRAVIS PIP REPAIR COUPLER

Size	Part No.	Price
6"	PIP-RC6	
8"	PIP-RC8	
10"	PIP-RC10	
12"	PIP-RC12	
15"	PIP-RC15	

PIERCE PIP CROSS

Size	Part No.	Price
4"	P1521-01	
6"	P1521-02	
8"	P1521-04	
10"	P1523-01	
12"	P1524-01	
15"	P1525-01	
18"	P1526-01	



TRAVIS PIP CROSS

Size	Part No.	Price
6"	PIPX6	
8"	PIPX8	
10"	PIPX10	
12"	PIPX12	
15"	PIPX15	

PIERCE PIP 90° ELBOW

Size	Part No.	Price
4"	P1556-01	
6"	P1558-01	
8"	P1558-02	
10"	P1558-03	
12"	P1558-04	
15"	P1560-01	



TRAVIS PIP 90° ELBOW

Size	Part No.	Price
6"	PIP-FE-6	
8"	PIP-FE-8	
10"	PIP-FE-10	
12"	PIP-FE-12	
15"	PIP-FE-15	
Add G after part number for galvanized (same price) example - PIP-FE-6-G		

PIERCE PIP 45° ELBOW

Size	Part No.	Price
4"	P1557-01	
6"	P1559-01	
8"	P1559-02	
10"	P1559-03	
12"	P1559-04	
15"	P1561-01	

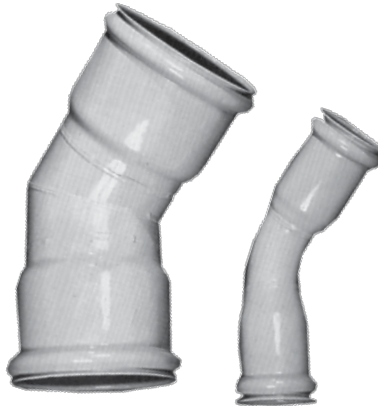

TRAVIS PIP 45° ELBOW

Size	Part No.	Price
6"	PIP-FE-6-45	
8"	PIP-FE-8-45	
10"	PIP-FE-10-45	
12"	PIP-FE-12-45	
15"	PIP-FE-15-45	
Add G after part number for galvanized (same price) example - PIP-FE-6-45-G		



TRAVIS PIP 22 1/2° ELBOW

Size	Part No.	Price
6"	PIP-FE-6-22	
8"	PIP-FE-8-22	
10"	PIP-FE-10-22	
12"	PIP-FE-12-22	
15"	PIP-FE-15-22	
Add G after part number for galvanized (same price) example - PIP-FE-6-22-G		

PIERCE PIP STRAIGHT TEE

Size	Part No.	Price
4"	P1510-01	
6"	P1510-02	
8"	P1510-04	
10"	P1511-02	
12"	P1512-05	
15"	P1516-04	
18"	P1517-07	



TRAVIS PIP STRAIGHT TEE

Size	Part No.	Price
6"	PIP-FT-666	
8"	PIP-FT-888	
10"	PIP-FT-101010	
12"	PIP-FT-121212	
15"	PIP-FT-151515	



TRAVIS PIP REDUCING TEE

Size	Part No.	Price
8" x 8" x 6"	PIP-RT-886	
10" x 10" x 6"	PIP-RT-10106	
10" x 10" x 8"	PIP-RT-10108	
12" x 12" x 8"	PIP-RT-12128	
12" x 12" x 10"	PIP-RT-121210	
15" x 15" x 10"	PIP-RT-151510	
15" x 15" x 12"	PIP-RT-151512	

PIERCE PIP SERVICE TEE WITH FIPT OUTLET

Size	Part No.	Price
4" x 3"	P1378-05	
6" x 3"	P1380-03	
6" x 4"	P1380-04	
8" x 3"	P1382-03	
8" x 4"	P1382-04	
10" x 2"	P1384-01	
10" x 3"	P1384-03	
10" x 4"	P1384-04	
12" x 2"	P1386-04	
12" x 3"	P1386-06	
12" x 4"	P1387-01	
15" x 2"	P1388-04	
15" x 3"	P1388-06	
15" x 4"	P1390-01	
18" x 2"	P1389-04	
18" x 4"	P1389-07	



TRAVIS PIP SERVICE TEE WITH FIPT OUTLET

Size	Part No.	Price
6" x 3"	PIP-63FT-FF	
6" x 4"	PIP-64FT-FF	
8" x 3"	PIP-83FT-FF	
8" x 4"	PIP-84FT-FF	
10" x 3"	PIP-103FT-FF	
10" x 4"	PIP-104FT-FF	
12" x 3"	PIP-123FT-FF	
12" x 4"	PIP-124FT-FF	
15" x 4"	PIP-154FT-FF	

TRAVIS PIP SERVICE TEE WITH MIPT OUTLET

Size	Part No.	Price
6" x 3"	PIP-63MT-FF	
6" x 4"	PIP-64MT-FF	
8" x 3"	PIP-83MT-FF	
8" x 4"	PIP-84MT-FF	
10" x 3"	PIP-103MT-FF	
10" x 4"	PIP-104MT-FF	
12" x 3"	PIP-123MT-FF	
12" x 4"	PIP-124MT-FF	
15" x 4"	PIP-154MT-FF	



**PIERCE
PIP TEE RISER (FEMALE X FEMALE)**

Size	Part No.	Price
4" x 4" x 4" x 30"	P1265-04	
4" x 4" x 4" x 36"	P1265-05	
4" x 4" x 4" x 42"	P1265-06	
6" x 6" x 4" x 30"	P1266-04	
6" x 6" x 4" x 36"	P1266-05	
6" x 6" x 4" x 42"	P1266-06	
8" x 8" x 4" x 30"	P1268-04	
8" x 8" x 4" x 36"	P1268-05	
8" x 8" x 4" x 42"	P1268-06	
10" x 10" x 4" x 30"	P1271-04	
10" x 10" x 4" x 36"	P1271-05	
10" x 10" x 4" x 42"	P1271-06	
12" x 12" x 4" x 30"	P1274-04	
12" x 12" x 4" x 36"	P1274-05	
12" x 12" x 4" x 42"	P1274-06	
6" x 6" x 6" x 30"	P1267-04	
6" x 6" x 6" x 36"	P1267-05	
6" x 6" x 6" x 42"	P1267-06	
8" x 8" x 6" x 30"	P1269-04	
8" x 8" x 6" x 36"	P1269-05	
8" x 8" x 6" x 42"	P1269-06	
10" x 10" x 6" x 30"	P1272-04	
10" x 10" x 6" x 36"	P1272-05	
10" x 10" x 6" x 42"	P1272-06	
12" x 12" x 6" x 30"	P1275-04	
12" x 12" x 6" x 36"	P1275-05	
12" x 12" x 6" x 42"	P1275-06	
10" x 10" x 8" x 30"	P1273-04	
10" x 10" x 8" x 36"	P1273-05	
10" x 10" x 8" x 42"	P1273-06	
12" x 12" x 8" x 42"	P1276-06	
15" x 15" x 8" x 36"	P3307-05	
15" x 15" x 8" x 42"	P3307-06	

**TRAVIS
PIP TEE RISER (FEMALE X FEMALE)**

Size	Part No.	Price
4" x 4" x 4" x 30"	PIP-4430-FF	
4" x 4" x 4" x 36"	PIP-4436-FF	
4" x 4" x 4" x 42"	PIP-4442-FF	
6" x 6" x 4" x 30"	PIP-6430-FF	
6" x 6" x 4" x 36"	PIP-6436-FF	
6" x 6" x 4" x 42"	PIP-6442-FF	
8" x 8" x 4" x 30"	PIP-8430-FF	
8" x 8" x 4" x 36"	PIP-8436-FF	
8" x 8" x 4" x 42"	PIP-8442-FF	
10" x 10" x 4" x 30"	PIP-10430-FF	
10" x 10" x 4" x 36"	PIP-10436-FF	
10" x 10" x 4" x 42"	PIP-10442-FF	
12" x 12" x 4" x 30"	PIP-12430-FF	
12" x 12" x 4" x 36"	PIP-12436-FF	
12" x 12" x 4" x 42"	PIP-12442-FF	
6" x 6" x 6" x 30"	PIP-6630-FF	
6" x 6" x 6" x 36"	PIP-6636-FF	
6" x 6" x 6" x 42"	PIP-6642-FF	
8" x 8" x 6" x 30"	PIP-8630-FF	
8" x 8" x 6" x 36"	PIP-8636-FF	
8" x 8" x 6" x 42"	PIP-8642-FF	
10" x 10" x 6" x 30"	PIP-10630-FF	
10" x 10" x 6" x 36"	PIP-10636-FF	
10" x 10" x 6" x 42"	PIP-10642-FF	
12" x 12" x 6" x 30"	PIP-12630-FF	
12" x 12" x 6" x 36"	PIP-12636-FF	
12" x 12" x 6" x 42"	PIPI-12642-FF	
10" x 10" x 8" x 30"	PIP-10830-FF	
10" x 10" x 8" x 36"	PIP-10836-FF	
10" x 10" x 8" x 42"	PIP-10842-FF	
12" x 12" x 8" x 42"	PIP-12842-FF	
15" x 15" x 8" x 36"	PIP-15836-FF	
15" x 15" x 8" x 42"	PIP-15842-FF	



**PIERCE
PIP TEE RISER (MALE X FEMALE)**

Size	Part No.	Price
4" x 4" x 4" x 30"	P1283-04	
4" x 4" x 4" x 36"	P1283-05	
4" x 4" x 4" x 42"	P1283-06	
6" x 6" x 4" x 30"	P1284-04	
6" x 6" x 4" x 36"	P1284-05	
6" x 6" x 4" x 42"	P1284-06	
8" x 8" x 4" x 30"	P1286-04	
8" x 8" x 4" x 36"	P1286-05	
8" x 8" x 4" x 42"	P1286-06	
10" x 10" x 4" x 30"	P1289-04	
10" x 10" x 4" x 36"	P1289-05	
10" x 10" x 4" x 42"	P1289-06	
12" x 12" x 4" x 30"	P1292-04	
12" x 12" x 4" x 36"	P1292-05	
12" x 12" x 4" x 42"	P1292-06	
6" x 6" x 6" x 30"	P1285-04	
6" x 6" x 6" x 36"	P1285-05	
6" x 6" x 6" x 42"	P1285-06	
8" x 8" x 6" x 30"	P1287-04	
8" x 8" x 6" x 36"	P1287-05	
8" x 8" x 6" x 42"	P1287-06	
10" x 10" x 6" x 30"	P1290-04	
10" x 10" x 6" x 36"	P1290-05	
10" x 10" x 6" x 42"	P1290-06	
12" x 12" x 6" x 30"	P1293-04	
12" x 12" x 6" x 36"	P1293-05	
12" x 12" x 6" x 42"	P1293-06	
10" x 10" x 8" x 30"	P1291-04	
10" x 10" x 8" x 36"	P1291-05	
10" x 10" x 8" x 42"	P1291-06	
12" x 12" x 8" x 42"	P1294-06	
15" x 15" x 8" x 36"	P3308-05	
15" x 15" x 8" x 42"	P3308-06	

**TRAVIS
PIP TEE RISER (MALE X FEMALE)**

Size	Part No.	Price
4" x 4" x 4" x 30"	PIP-4430-MF	
4" x 4" x 4" x 36"	PIP-4436-MF	
4" x 4" x 4" x 42"	PIP-4442-MF	
6" x 6" x 4" x 30"	PIP-6430-MF	
6" x 6" x 4" x 36"	PIP-6436-MF	
6" x 6" x 4" x 42"	PIP-6442-MF	
8" x 8" x 4" x 30"	PIP-8430-MF	
8" x 8" x 4" x 36"	PIP-8436-MF	
8" x 8" x 4" x 42"	PIP-8442-MF	
10" x 10" x 4" x 30"	PIP-10430-MF	
10" x 10" x 4" x 36"	PIP-10436-MF	
10" x 10" x 4" x 42"	PIP-10442-MF	
12" x 12" x 4" x 30"	PIP-12430-MF	
12" x 12" x 4" x 36"	PIP-12436-MF	
12" x 12" x 4" x 42"	PIP-12442-MF	
6" x 6" x 6" x 30"	PIP-6630-MF	
6" x 6" x 6" x 36"	PIP-6636-MF	
6" x 6" x 6" x 42"	PIP-6642-MF	
8" x 8" x 6" x 30"	PIP-8630-MF	
8" x 8" x 6" x 36"	PIP-8636-MF	
8" x 8" x 6" x 42"	PIP-8642-MF	
10" x 10" x 6" x 30"	PIP-10630-MF	
10" x 10" x 6" x 36"	PIP-10636-MF	
10" x 10" x 6" x 42"	PIP-10642-MF	
12" x 12" x 6" x 30"	PIP-12630-MF	
12" x 12" x 6" x 36"	PIP-12636-MF	
12" x 12" x 6" x 42"	PIPI-12642-MF	
10" x 10" x 8" x 30"	PIP-10830-MF	
10" x 10" x 8" x 36"	PIP-10836-MF	
10" x 10" x 8" x 42"	PIP-10842-MF	
12" x 12" x 8" x 42"	PIP-12842-MF	
15" x 15" x 8" x 36"	PIP-15836-MF	
15" x 15" x 8" x 42"	PIP-15842-MF	

INTRO
1. ELECTRICAL
2. PUMP ACC.
3. HOSE, PE PIPE & ACC.
4. IPS, PIP PIPE & ACC.
5. SURFACE
6. SPRINKLERS
7. TRAVELER & WHEEL MOVE
8. PIVOT
9. TURF
10. LOW VOLUME
11. FILTERS
12. INJECTION
13. HARDWARE
INDEX



PIERCE PIP CAP RISERS

Size	Part No.	Price
4" x 4" x 30"	P1295-04	
4" x 4" x 36"	P1295-05	
4" x 4" x 42"	P1295-06	
6" x 4" x 30"	P1296-04	
6" x 4" x 36"	P1296-05	
6" x 4" x 42"	P1296-06	
8" x 4" x 30"	P1298-04	
8" x 4" x 36"	P1298-05	
8" x 4" x 42"	P1298-06	
10" x 4" x 30"	P1301-04	
10" x 4" x 36"	P3868-05	
10" x 4" x 42"	P1301-06	
12" x 4" x 30"	P1304-04	
12" x 4" x 36"	P1304-05	
12" x 4" x 42"	P1304-06	
6" x 6" x 30"	P1297-04	
6" x 6" x 36"	P1297-05	
6" x 6" x 42"	P1297-06	
8" x 6" x 30"	P1299-04	
8" x 6" x 36"	P1299-05	
8" x 6" x 42"	P1299-06	
10" x 6" x 30"	P1302-04	
10" x 6" x 36"	P1302-05	
10" x 6" x 42"	P1302-06	
12" x 6" x 30"	P1305-04	
12" x 6" x 36"	P1305-05	
12" x 6" x 42"	P1305-06	
10" x 8" x 30"	P1303-04	
10" x 8" x 36"	P1303-05	
10" x 8" x 42"	P1303-06	
12" x 8" x 42"	P0058-17	
15" x 8" x 36"	P3309-05	
15" x 8" x 42"	P3309-06	

TRAVIS PIP CAP RISERS

Size	Part No.	Price
4" x 4" x 30"	PIP-4430-FC	
4" x 4" x 36"	PIP-4436-FC	
4" x 4" x 42"	PIP-4442-FC	
6" x 4" x 30"	PIP-6430-FC	
6" x 4" x 36"	PIP-6436-FC	
6" x 4" x 42"	PIP-6442-FC	
8" x 4" x 30"	PIP-8430-FC	
8" x 4" x 36"	PIP-8436-FC	
8" x 4" x 42"	PIP-8442-FC	
10" x 4" x 30"	PIP-10430-FC	
10" x 4" x 36"	PIP-10436-FC	
10" x 4" x 42"	PIP-10442-FC	
12" x 4" x 30"	PIP-12430-FC	
12" x 4" x 36"	PIP-12436-FC	
12" x 4" x 42"	PIP-12442-FC	
6" x 6" x 30"	PIP-6630-FC	
6" x 6" x 36"	PIP-6636-FC	
6" x 6" x 42"	PIP-6642-FC	
8" x 6" x 30"	PIP-8630-FC	
8" x 6" x 36"	PIP-8636-FC	
8" x 6" x 42"	PIP-8642-FC	
10" x 6" x 30"	PIP-10630-FC	
10" x 6" x 36"	PIP-10636-FC	
10" x 6" x 42"	PIP-10642-FC	
12" x 6" x 30"	PIP-12630-FC	
12" x 6" x 36"	PIP-12636-FC	
12" x 6" x 42"	PIP-12642-FC	
10" x 8" x 30"	PIP-10830-FC	
10" x 8" x 36"	PIP-10836-FC	
10" x 8" x 42"	PIP-10842-FC	
12" x 8" x 42"	PIP-12842-FC	
15" x 8" x 36"	PIP-15836-FC	
15" x 8" x 42"	PIP-15842-FC	

**PIERCE
ELBOW OPTION FOR TEE & CAP RISER**

Size	Part No.	Price
2" MIPT SWEEP	P2MIPT-SE	
3" MIPT SWEEP	P3MIPT-SE	
4" MIPT SWEEP	P4MIPT-SE	
2" FIPT SWEEP	P2FIPT-SE	
3" FIPT SWEEP	P3FIPT-SE	
4" FIPT SWEEP	P4FIPT-SE	



**TRAVIS
ELBOW OPTION FOR TEE & CAP RISER**

Size	Part No.	Price
2" MIPT SWEEP	IPS-200MIPT-SE	
3" MIPT SWEEP	IPS-300MIPT-SE	
4" MIPT SWEEP	IPS-400MIPT-SE	
2" FIPT SWEEP	IPS-200FIPT-SE	
3" FIPT SWEEP	IPS-300FIPT-SE	
4" FIPT SWEEP	IPS-400FIPT-SE	

**PIERCE
PIP REDUCER (FEMALE X FEMALE)**

Size	Part No.	Price
8" x 6"	P1537-02	
10" x 8"	P1537-03	
12" x 10"	P1537-04	

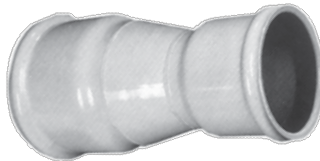

**TRAVIS
PIP REDUCER (FEMALE X FEMALE)**

Size	Part No.	Price
8" x 6"	PIP-R86	
10" x 6"	PIP-R106	
10" x 8"	PIP-R108	
12" x 8"	PIP-R128	
12" x 10"	PIP-R1210	
15" x 12"	PIP-R1512	

PIERCE PIP END CAP

Size	Part No.	Price
6"	P1589-02	
8"	P1589-03	
10"	P1589-04	



TRAVIS PIP END CAP

Size	Part No.	Price
6"	PIP-FEP-6	
8"	PIP-FEP-8	
10"	PIP-FEP-10	
12"	PIP-FEP-12	

TRAVIS PIP END PLUG

Size	Part No.	Price
6"	PIP-EP-6	
8"	PIP-EP-8	
10"	PIP-EP-10	
12"	PIP-EP-12	
15"	PIP-EP-15	

PIERCE PIP COMPRESSION GASKET

Size	Part No.	Price
4"	P1609-01	
6"	P1610-01	
8"	P1611-01	
10"	P1612-01	
12"	P1613-01	
15"	P1614-01	
18"	P1615-01	



Travis Old Style with Plastic Snap Ring is Still Available. Call for Pricing.

TRAVIS PIP COMPRESSION GASKET

Size	Part No.	Price
6"	PIP-CG-6	
8"	PIP-CG-8	
10"	PIP-CG-10	
12"	PIP-CG-12	
15"	PIP-CG-15	

STEEL SADDLE WITH STUB

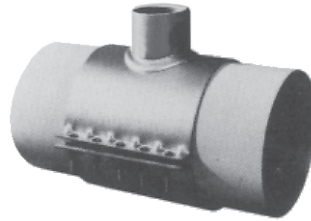

TRAVIS GALVANIZED WITH 4" PLAIN END STUB

Size	Part No.	Price
5"	SSG-45	
6"	SSG-46	
8"	SSG-48	
10"	SSG-410	
12"	SSG-412	
15"	SSG-415	

TRAVIS EPOXY WITH 4" PLAIN END STUB

Size	Part No.	Price
5"	SSE-45	
6"	SSE-46	
8"	SSE-48	
10"	SSE-410	
12"	SSE-412	
15"	SSE-415	

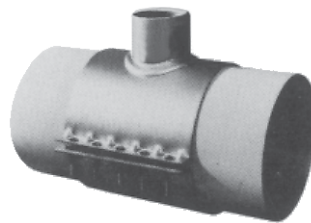

TRAVIS GALVANIZED WITH 6" PLAIN END STUB

Size	Part No.	Price
8"	SSG-68	
10"	SSG-610	
12"	SSG-612	
15"	SSG-615	

TRAVIS EPOXY WITH 6" PLAIN END STUB

Size	Part No.	Price
8"	SSE-68	
10"	SSE-610	
12"	SSE-612	
15"	SSE-615	

STEEL SADDLE WITH 3" FIPT OUTLET

PIERCE GALVANIZED W/ 3" FIPT OUTLET

Size	Part No.	Price
6"	P1311-92	
8"	P1312-92	
10"	P1313-92	
12"	P1314-92	

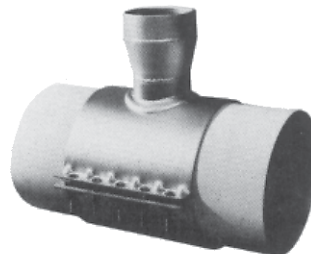

TRAVIS GALVANIZED W/ 3" FIPT OUTLET

Size	Part No.	Price
5"	SSG-TF-35	
6"	SSG-TF-36	
8"	SSG-TF-38	
10"	SSG-TF-310	
12"	SSG-TF-312	
15"	SSG-TF-315	

PIERCE EPOXY WITH 3" FIPT OUTLET

Size	Part No.	Price
6"	P1311-82	
8"	P1312-82	
10"	P1313-82	
12"	P1314-82	

TRAVIS EPOXY WITH 3" FIPT OUTLET

Size	Part No.	Price
5"	SSE-TF-35	
6"	SSE-TF-36	
8"	SSE-TF-38	
10"	SSE-TF-310	
12"	SSE-TF-312	
15"	SSE-TF-315	

STEEL SADDLE WITH 4" FIPT OUTLET

PIERCE GALVANIZED W/ 4" FIPT OUTLET

Size	Part No.	Price
6"	P1311-93	
8"	P1312-93	
10"	P1313-93	
12"	P1314-93	

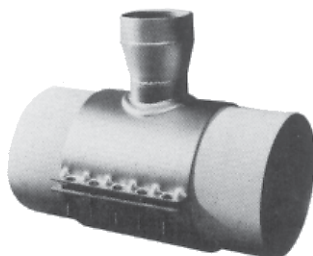

PIERCE EPOXY WITH 4" FIPT OUTLET

Size	Part No.	Price
6"	P1311-83	
8"	P1312-83	
10"	P1313-83	
12"	P1314-83	

TRAVIS GALVANIZED W/ 4" FIPT OUTLET

Size	Part No.	Price
5"	SSG-TF-45	
6"	SSG-TF-46	
8"	SSG-TF-48	
10"	SSG-TF-410	
12"	SSG-TF-412	
15"	SSG-TF-415	

TRAVIS EPOXY WITH 4" FIPT OUTLET

Size	Part No.	Price
5"	SSE-TF-45	
6"	SSE-TF-46	
8"	SSE-TF-48	
10"	SSE-TF-410	
12"	SSE-TF-412	
15"	SSE-TF-415	

STEEL SADDLE WITH 6" FIPT OUTLET

TRAVIS GALVANIZED W/ 6" FIPT OUTLET

Size	Part No.	Price
8"	SSG-TF-68	
10"	SSG-TF-610	
12"	SSG-TF-612	
15"	SSG-TF-615	

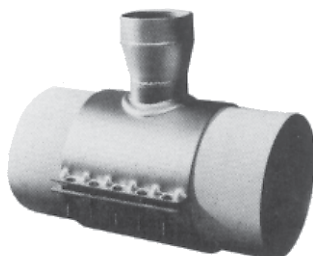

TRAVIS EPOXY WITH 6" FIPT OUTLET

Size	Part No.	Price
8"	SSE-TF-68	
10"	SSE-TF-610	
12"	SSE-TF-612	
15"	SSE-TF-615	

STEEL SADDLE WITH 3" MIPT OUTLET

TRAVIS GALVANIZED W/ 3" MIPT OUTLET

Size	Part No.	Price
5"	SSG-TM-35	
6"	SSG-TM-36	
8"	SSG-TM-38	
10"	SSG-TM-310	
12"	SSG-TM-312	
15"	SSG-TM-315	



TRAVIS EPOXY WITH 3" MIPT OUTLET

Size	Part No.	Price
5"	SSE-TM-35	
6"	SSE-TM-36	
8"	SSE-TM-38	
10"	SSE-TM-310	
12"	SSE-TM-312	
15"	SSE-TM-315	

INTRO
 1. ELECTRICAL
 2. PUMP Acc.
 3. HOSE, PE PIPE & Acc.
 4. IPS, PIP PIPE & Acc.
 5. SURFACE
 6. SPRINKLERS
 7. TRAVELER & WHEEL MOVE
 8. PIVOT
 9. TURN
 10. LOW VOLUME
 11. FILTERS
 12. INJECTION
 13. HARDWARE
 INDEX

STEEL SADDLE WITH 4" MIPT OUTLET



TRAVIS GALVANIZED WITH 4" MIPT OUTLET

Size	Part No.	Price
5"	SSG-TM-45	
6"	SSG-TM-46	
8"	SSG-TM-48	
10"	SSG-TM-410	
12"	SSG-TM-412	
15"	SSG-TM-415	

TRAVIS EPOXY WITH 4" MIPT OUTLET

Size	Part No.	Price
5"	SSE-TM-45	
6"	SSE-TM-46	
8"	SSE-TM-48	
10"	SSE-TM-410	
12"	SSE-TM-412	
15"	SSE-TM-415	

STEEL SADDLE WITH 36" RISER AND 4" VALVE

PIERCE GALVANIZED WITH 36" RISER & 4" VALVE

Size	Part No.	Price
6"	P3586-85	
8"	P3672-85	
10"	P3670-85	
12"	P3671-85	



TRAVIS GALVANIZED WITH 36" RISER & 4" VALVE

Size	Part No.	Price
5"	SSG-436-5	
6"	SSG-436-6	
8"	SSG-436-8	
10"	SSG-436-10	
12"	SSG-436-12	
15"	SSG-436-15	

PIERCE EPOXY WITH 36" RISER & 4" VALVE

Size	Part No.	Price
6"	P1320-85	
8"	P1323-85	
10"	P1326-85	
12"	P1329-85	

TRAVIS EPOXY WITH 36" RISER & 4" VALVE

Size	Part No.	Price
5"	SSE-436-5	
6"	SSE-436-6	
8"	SSE-436-8	
10"	SSE-436-10	
12"	SSE-436-12	
15"	SSE-436-15	

STEEL SADDLE WITH 36" RISER AND 6" VALVE



TRAVIS GALVANIZED WITH 36" RISER & 6" VALVE

Size	Part No.	Price
8"	SSG-636-8	
10"	SSG-636-10	
12"	SSG-636-12	
15"	SSG-636-15	

TRAVIS EPOXY WITH 36" RISER & 6" VALVE

Size	Part No.	Price
8"	SSE-636-8	
10"	SSE-636-10	
12"	SSE-636-12	
15"	SSE-636-15	



BOLT TITE DISCHARGE ADAPTER

IPS

Coupler Size	Flange Size	Part No.	Price
4"	2"	IPSBTDA204	
4"	3"	IPSBTDA304	
4"	4"	IPSBTDA404	
5"	3"	IPSBTDA305	
5"	4"	IPSBTDA405	
5"	5"	IPSBTDA505	
6"	3"	IPSBTDA306	
6"	4"	IPSBTDA406	
6"	5"	IPSBTDA506	
6"	6"	IPSBTDA606	
8"	4"	IPSBTDA408	
8"	5"	IPSBTDA508	
8"	6"	IPSBTDA608	
8"	8"	IPSBTDA808	
10"	4"	IPSBTDA410	
10"	5"	IPSBTDA510	
10"	6"	IPSBTDA610	
10"	8"	IPSBTDA810	
10"	10"	IPSBTDA1010	
12"	8"	IPSBTDA812	
12"	10"	IPSBTDA1012	
12"	12"	IPSBTDA1212	

PIP

Coupler Size	Flange Size	Part No.	Price
6"	6"	PIPBTD606	
8"	6"	PIPBTD608	
8"	8"	PIPBTD808	
10"	6"	PIPBTD610	
10"	8"	PIPBTD810	
10"	10"	PIPBTD1010	
12"	8"	PIPBTD812	
12"	10"	PIPBTD1012	
12"	12"	PIPBTD1212	
15"	12"	PIPBTD1215	
15"	14"	PIPBTD1415	
15"	16"	PIPBTD1615	
18.7"	18"	PIPBTD1818	
20.4"	16"	PIPBTD1620	
20.4"	18"	PIPBTD1820	
20.4"	20"	PIPBTD2020	



BOLT TITE 90° ELBOW

IPS

Size	Part No.	Price
4"	IPSBTFE4	
5"	IPSBTFE5	
6"	IPSBTFE6	
8"	IPSBTFE8	
10"	IPSBTFE10	
12"	IPSBTFE12	

PIP

Size	Part No.	Price
6"	PIPBTFE6	
8"	PIPBTFE8	
10"	PIPBTFE10	
12"	PIPBTFE12	
15"	PIPBTFE15	
18.7"	PIPBTFE18.7	
20.4"	PIPBTFE20.4	



BOLT TITE 45° ELBOW

IPS

Size	Part No.	Price
4"	IPSBTFE4-45	
5"	IPSBTFE5-45	
6"	IPSBTFE6-45	
8"	IPSBTFE8-45	
10"	IPSBTFE10-45	
12"	IPSBTFE12-45	

PIP

Size	Part No.	Price
6"	PIPBTFE6-45	
8"	PIPBTFE8-45	
10"	PIPBTFE10-45	
12"	PIPBTFE12-45	
15"	PIPBTFE15-45	
18.7"	PIPBTFE18.7-45	
20.4"	PIPBTFE20.4-45	

**BOLT TITE MALE
THREADED RISER COUPLER 10"**

IPS

Coupler Size	Thread Size	Part No.	Price
4" x 10"	3"	IPS10BT43MT	
5" x 10"	3"	IPS10BT53MT	
6" x 10"	3"	IPS10BT63MT	
8" x 10"	3"	IPS10BT83MT	
10" x 10"	3"	IPS10BT103MT	
12" x 10"	3"	IPS10BT123MT	
4" x 10"	4"	IPS10BT44MT	
5" x 10"	4"	IPS10BT54MT	
6" x 10"	4"	IPS10BT64MT	
8" x 10"	4"	IPS10BT84MT	
10" x 10"	4"	IPS10BT104MT	
12" x 10"	4"	IPS10BT124MT	

PIP / OD

Coupler Size	Thread Size	Part No.	Price
6" x 10"	3"	PIP10BT63MT	
8" x 10"	3"	PIP10BT83MT	
10" x 10"	3"	PIP10BT103MT	
12" x 10"	3"	PIP10BT123MT	
6" x 10"	4"	PIP10BT64MT	
8" x 10"	4"	PIP10BT84MT	
10" x 10"	4"	PIP10BT104MT	
12" x 10"	4"	PIP10BT124MT	



**BOLT TITE MALE
THREADED RISER COUPLER 18"**

IPS

Coupler Size	Thread Size	Part No.	Price
4" x 18"	3"	IPS18BT43MT	
5" x 18"	3"	IPS18BT53MT	
6" x 18"	3"	IPS18BT63MT	
8" x 18"	3"	IPS18BT83MT	
10" x 18"	3"	IPS18BT103MT	
12" x 18"	3"	IPS18BT123MT	
4" x 18"	4"	IPS18BT44MT	
5" x 18"	4"	IPS18BT54MT	
6" x 18"	4"	IPS18BT64MT	
8" x 18"	4"	IPS18BT84MT	
10" x 18"	4"	IPS18BT104MT	
12" x 18"	4"	IPS18BT124MT	

PIP

Coupler Size	Thread Size	Part No.	Price
6" x 18"	3"	PIP18BT63MT	
8" x 18"	3"	PIP18BT83MT	
10" x 18"	3"	PIP18BT103MT	
12" x 18"	3"	PIP18BT123MT	
6" x 18"	4"	PIP18BT64MT	
8" x 18"	4"	PIP18BT84MT	
10" x 18"	4"	PIP18BT104MT	
12" x 18"	4"	PIP18BT124MT	

**BOLT TITE FEMALE
THREADED RISER COUPLER 10"**

IPS

Coupler Size	Thread Size	Part No.	Price
4" x 10"	3"	IPS10BT43FT	
5" x 10"	3"	IPS10BT53FT	
6" x 10"	3"	IPS10BT63FT	
8" x 10"	3"	IPS10BT83FT	
10" x 10"	3"	IPS10BT103FT	
12" x 10"	3"	IPS10BT123FT	
4" x 10"	4"	IPS10BT44FT	
5" x 10"	4"	IPS10BT54FT	
6" x 10"	4"	IPS10BT64FT	
8" x 10"	4"	IPS10BT84FT	
10" x 10"	4"	IPS10BT104FT	
12" x 10"	4"	IPS10BT124FT	

PIP / OD

Coupler Size	Thread Size	Part No.	Price
6" x 10"	3"	PIP10BT63FT	
8" x 10"	3"	PIP10BT83FT	
10" x 10"	3"	PIP10BT103FT	
12" x 10"	3"	PIP10BT123FT	
6" x 10"	4"	PIP10BT64FT	
8" x 10"	4"	PIP10BT84FT	
10" x 10"	4"	PIP10BT104FT	
12" x 10"	4"	PIP10BT124FT	



**BOLT TITE FEMALE
THREADED RISER COUPLER 18"**

IPS

Coupler Size	Thread Size	Part No.	Price
4" x 18"	3"	IPS18BT43FT	
5" x 18"	3"	IPS18BT53FT	
6" x 18"	3"	IPS18BT63FT	
8" x 18"	3"	IPS18BT83FT	
10" x 18"	3"	IPS18BT103FT	
12" x 18"	3"	IPS18BT123FT	
4" x 18"	4"	IPS18BT44FT	
5" x 18"	4"	IPS18BT54FT	
6" x 18"	4"	IPS18BT64FT	
8" x 18"	4"	IPS18BT84FT	
10" x 18"	4"	IPS18BT104FT	
12" x 18"	4"	IPS18BT124FT	

PIP

Coupler Size	Thread Size	Part No.	Price
6" x 18"	3"	PIP18BT63FT	
8" x 18"	3"	PIP18BT83FT	
10" x 18"	3"	PIP18BT103FT	
12" x 18"	3"	PIP18BT123FT	
6" x 18"	4"	PIP18BT64FT	
8" x 18"	4"	PIP18BT84FT	
10" x 18"	4"	PIP18BT104FT	
12" x 18"	4"	PIP18BT124FT	



TRAVIS BOLT TITE TEE

IPS

Size	Part No.	Price
4"	IPSBTFT4	
5"	IPSBTFT5	
6"	IPSBTFT6	
8"	IPSBTFT8	
10"	IPSBTFT10	
12"	IPSBTFT12	

PIP

Size	Part No.	Price
6"	PIPBTF6	
8"	PIPBTF8	
10"	PIPBTF10	
12"	PIPBTF12	
15"	PIPBTF15	
18.7"	PIPBTF18.7	
20.4"	PIPBTF20.4	



TRAVIS BOLT TITE CROSS

IPS

Size	Part No.	Price
4"	IPSBTX4	
5"	IPSBTX5	
6"	IPSBTX6	
8"	IPSBTX8	
10"	IPSBTX10	
12"	IPSBTX12	

PIP

Size	Part No.	Price
6"	PIPBTX6	
8"	PIPBTX8	
10"	PIPBTX10	
12"	PIPBTX12	
15"	PIPBTX15	
18.7"	PIPBTX18.7	
20.4"	PIPBTX20.4	

BOLT TITE & WEDGE-TITE® GASKET

PIERCE IPS WEDGE-TITE® GASKETS

Size	Part No.	Price
4"	P1640-02	
5"	P1640-03	
6"	P1640-04	
8"	P1640-05	
10"	P1640-06	
12"	P1640-07	



TRAVIS IPS BOLT TITE GASKETS

Size	Part No.	Price
4"	IPSBTG4	
5"	IPSBTG5	
6"	IPSBTG6	
8"	IPSBTG8	
10"	IPSBTG10	
12"	IPSBTG12	

PIERCE PIP / OD WEDGE-TITE® GASKETS

Size	Part No.	Price
4"	P1638-02	
6"	P1638-04	
8"	P1638-05	
10"	P1638-06	
12"	P1638-07	
15"	F088-3152	



TRAVIS PIP / OD BOLT TITE GASKETS

Size	Part No.	Price
6"	PIPB6G6	
8"	PIPB6G8	
10"	PIPB6G10	
12"	PIPB6G12	
15"	PIPB6G15	
18.7"	PIPB6G18.7	
20.4"	PIPB6G20.4	



**PIERCE
WEDGE-TITE® WELD-ON COUPLER SET**

Size	IPS Part No.	PIP Part No.	Nominal Part No.	Price
4"	P9017-01	P9017-03	P9017-05	
5"	P9018-01	-	P9018-03	
6"	P9019-01	P9019-03	P9019-05	
8"	P9020-01	P9020-03	P9020-05	
10"	P9021-01	P9021-03	P9021-05	
12"	P9022-01	P9022-03	P9022-05	
15"	-	P9023-01	-	
18"	-	P2294-26	-	



**TRAVIS
BOLT TITE WELD-ON COUPLER SET**

Size	IPS Part No.	Price	PIP Part No.	Price
4"	IPS-BTSC-4		-	
5"	IPS-BTSC-5		-	
6"	IPS-BTSC-6		PIP-BTSC-6	
8"	IPS-BTSC-8		PIP-BTSC-8	
10"	IPS-BTSC-10		PIP-BTSC-10	
12"	IPS-BTSC-12		PIP-BTSC-12	
15"	-	-	PIP-BTSC-15	
18.7"	-	-	PIP-BTSC-18.7	
20.4"	-	-	PIP-BTSC-20.4	

PIERCE WEDGE-TITE® WELD-ON COUPLER

Size	Part No.	Price
4"	P1591-12	
5"	P1591-13	
6"	P1591-14	
8"	P1591-15	
10"	P1591-16	
12"	P1591-17	
15"	P2294-25	
18"	P2294-29	



TRAVIS BOLT TITE WELD-ON COUPLER

Size	Part No.	Price
4"	BTBS-4	
5"	BTBS-5	
6"	BTBS-6	
8"	BTBS-8	
10"	BTBS-10	
12"	BTBS-12	
15"	BTBS-15	
18.7"	BTBS-18.7	
20.4"	BTBS-20.4	

PIERCE WEDGE-TITE® FLANGE PACK OPTIONS

Size	IPS Part No.	PIP Part No.	Nominal Part No.	Price
4"	P1641-02	P1642-01	P1643-02	
5"	P1641-03	-	P1643-03	
6"	P1641-04	P1642-02	P1643-04	
8"	P1641-05	P1642-03	P1643-05	
10"	P1641-06	P1642-04	P1643-06	
12"	P1641-07	P1642-05	P1643-07	
15"	-	P1642-06	-	
18"	-	P1642-07	-	



TRAVIS BOLT TITE FLANGE PACK OPTIONS

Size	IPS Part No.	Price	PIP Part No.	Price
4"	IPS-SFP-4		-	
5"	IPS-SFP-5		-	
6"	IPS-SFP-6		PIP-SFP-6	
8"	IPS-SFP-8		PIP-SFP-8	
10"	IPS-SFP-10		PIP-SFP-10	
12"	IPS-SFP-12		PIP-SFP-12	
15"	-	-	PIP-SFP-15	
18.7"	-	-	PIP-SFP-18.7	
20.4"	-	-	PIP-SFP-20.4	

BOLTED REPAIR COUPLINGS



**PIERCE
WEDGE-TITE® REPAIR COUPLER SET 10" BODY**

Size	IPS Part No.	PIP Part No.	Nominal Part No.	Price
4"	P9075-01	P9075-03	P9075-05	
5"	P9076-01	-	P9076-04	
6"	P9077-01	P9077-03	P9077-05	
8"	P9078-01	P9078-03	P9078-05	
10"	P9079-01	P9079-03	P9079-05	
12"	P9080-01	P9080-03	P9080-05	
15"	-	P9081-01	-	



**TRAVIS
BOLT TITE COUPLER SET 10" BODY**

Size	IPS Part No.	Price	PIP Part No.	Price
4"	IPS-BT-4-10		-	
5"	IPS-BT-5-10		-	
6"	IPS-BT-6-10		PIP-BT-6-10	
8"	IPS-BT-8-10		PIP-BT-8-10	
10"	IPS-BT-10-10		PIP-BT-10-10	
12"	IPS-BT-12-10		PIP-BT-12-10	
15"	-	-	PIP-BT-15-10	

PIERCE WEDGE-TITE® 10" COUPLER BODY ONLY

Size	Part No.	Price
4"	P1594-12	
5"	P1594-13	
6"	P1594-14	
8"	P1594-15	
10"	P1594-16	
12"	P1594-17	
15"	P1594-18	



TRAVIS BOLT TITE 10" COUPLER BODY ONLY

Size	Part No.	Price
4"	BTB-4-10	
5"	BTB-5-10	
6"	BTB-6-10	
8"	BTB-8-10	
10"	BTB-10-10	
12"	BTB-12-10	
15"	BTB-15-10	

PIERCE WEDGE-TITE® 10" BODY FLANGE PACKS

Size	IPS Part No.	PIP Part No.	Nominal Part No.	Price
4"	P1647-02	P1648-01	P1649-02	
5"	P1647-03	-	P1649-03	
6"	P1647-04	P1648-02	P1649-04	
8"	P1647-05	P1648-03	P1649-05	
10"	P1647-06	P1648-04	P1649-06	
12"	P1647-07	P1648-05	P1649-07	
15"	-	P1648-06	-	



TRAVIS BOLT TITE 10" BODY FLANGE PACKS

Size	IPS Part No.	Price	PIP Part No.	Price
4"	IPS-LFP-4		-	
5"	IPS-LFP-5		-	
6"	IPS-LFP-6		PIP-LFP-6	
8"	IPS-LFP-8		PIP-LFP-8	
10"	IPS-LFP-10		PIP-LFP-10	
12"	IPS-LFP-12		PIP-LFP-12	
15"	-	-	PIP-LFP-15	

For more Bolted Couplers See Section 2

BOLTED REPAIR COUPLINGS



**PIERCE
WEDGE-TITE® REPAIR COUPLER SET 16" BODY**

Size	IPS Part No.	PIP Part No.	Nominal Part No.	Price
4"	P9083-01	P9083-03	P9083-05	
5"	P9084-01	-	P9084-03	
6"	P9085-01	P9085-03	P9085-05	
8"	P9086-01	P9086-03	P9086-05	
10"	P9087-01	P9087-03	P9087-05	
12"	P9088-01	P9088-03	P9088-05	
15"	-	P9089-01	-	
18"	-	P2293-56	-	



**TRAVIS
BOLT TITE REPAIR COUPLER SET 18" BODY**

Size	IPS Part No.	Price	PIP Part No.	Price
4"	IPS-BT-4-18		-	
5"	IPS-BT-5-18		-	
6"	IPS-BT-6-18		PIP-BT-6-18	
8"	IPS-BT-8-18		PIP-BT-8-18	
10"	IPS-BT-10-18		PIP-BT-10-18	
12"	IPS-BT-12-18		PIP-BT-12-18	
15"	-	-	PIP-BT-15-18	
18.7"	-	-	PIP-BT-18.7-18	
20.4"	-	-	PIP-BT-20.4-18	

PIERCE WEDGE-TITE® 16" COUPLER BODY ONLY

Size	Part No.	Price
4"	P1595-12	
5"	P1595-13	
6"	P1595-14	
8"	P1595-15	
10"	P1595-16	
12"	P1595-17	
15"	P2293-25	
18"	P2293-26	



TRAVIS BOLT TITE 18" COUPLER BODY ONLY

Size	Part No.	Price
4"	BTB-4-18	
5"	BTB-5-18	
6"	BTB-6-18	
8"	BTB-8-18	
10"	BTB-10-18	
12"	BTB-12-18	
15"	BTB-15-18	
18.7"	BTB-18.7-18	
20.4"	BTB-20.4-18	

PIERCE WEDGE-TITE® 16" BODY FLANGE PACKS

Size	IPS Part No.	PIP Part No.	Nominal Part No.	Price
4"	P1641-02	P1642-01	P1643-02	
5"	P1641-03	-	P1643-03	
6"	P1641-04	P1642-02	P1643-04	
8"	P1641-05	P1642-03	P1643-05	
10"	P1641-06	P1642-04	P1643-06	
12"	P1641-07	P1642-05	P1643-07	
15"	-	P1642-06	-	
18"	-	P1642-07	-	



TRAVIS BOLT TITE 18" BODY FLANGE PACKS

Size	IPS Part No.	Price	PIP Part No.	Price
4"	IPS-FP-4		-	
5"	IPS-FP-5		-	
6"	IPS-FP-6		PIP-FP-6	
8"	IPS-FP-8		PIP-FP-8	
10"	IPS-FP-10		PIP-FP-10	
12"	IPS-FP-12		PIP-FP-12	
15"	-	-	PIP-FP-15	
18.7"	-	-	PIP-FP-18.7	
20.4"	-	-	PIP-FP-20.4	

For more Bolted Couplers See Section 2

BARTOS IPS RED BOLTED STEEL COUPLER

Size	Body Length	Part No.	Price
3"	10"	BCPP3L	
4"	10"	BCPP4L	
6"	10"	BCPP6L	
8"	12"	BCPP8L	
10"	12"	BCPP10L	
12"	12"	BCPP12L	



BARTOS PIP BLACK BOLTED STEEL COUPLER

Size	Body Length	Part No.	Price
4"	10"	BC410	
6"	10"	BC610	
8"	10"	BC810	
10"	12"	BC1012	
12"	12"	BC1212	
14"	12"	BC1412	
15"	12"	BC1512	
16"	12"	BC1612	
18"	18"	BC1812	
21"	18"	BC2012	



PVC FITTINGS IPS BOLTED COUPLER - 125 PSI PVC BODY & STEEL FLANGES

Size	Body Length	Part No.	Price
6"	12"	IPSGBC002	
8"	12"	IPSGBC052	
10"	12"	IPSGBC102	
12"	12"	IPSGBC152	



PVC FITTINGS PIP BOLTED COUPLER - 100 PSI PVC BODY & STEEL FLANGES

Size	Body Length	Part No.	Price
6"	12"	PIPGBC001	
8"	12"	PIPGBC051	
10"	12"	PIPGBC101	
12"	12"	PIPGBC151	
15"	12"	PIPGBC252	



NACO PVC PIP BOLTED COUPLER - 100 PSI

Size	Body Length	Part No.	Price
6"	12"	2928-060	
8"	12"	2928-080	
10"	12"	2928-100	
12"	12"	2928-120	
14"	12"	2928-140	
15"	12"	2928-150	



For more Bolted Couplers See Section 2

**LITTLE GIANT PVC IPS BOLTED COUPLER - 125 PSI
PVC BODY & FIBERGLASS FLANGES**

Size	Body Length	Part No.	Price
4"	12"	LG-IRCIPS-12-4	
4"	18"	LG-IRCIPS-18-4	
6"	12"	LG-IRCIPS-12-6	
6"	18"	LG-IRCIPS-18-6	
8"	12"	LG-IRCIPS-12-8	
8"	18"	LG-IRCIPS-18-8	
10"	12"	LG-IRCIPS-12-10	
10"	18"	LG-IRCIPS-18-10	



**LITTLE GIANT
PVC PIP BOLTED COUPLER - 100 PSI
PVC BODY & FIBERGLASS FLANGES**

Size	Body Length	Part No.	Price
6"	12"	LG-IRCPIP-12-6	
6"	18"	LG-IRCPIP-18-6	
8"	12"	LG-IRCPIP-12-8	
8"	18"	LG-IRCPIP-18-8	
10"	12"	LG-IRCPIP-12-10	
10"	18"	LG-IRCPIP-18-10	
12"	12"	LG-IRCPIP-12-12	
12"	18"	LG-IRCPIP-18-12	



**LITTLE GIANT
FIBERGLASS IPS BOLTED COUPLER - 300 PSI
FIBERGLASS BODY & FLANGES**

Size	Body Length	Part No.	Price
4"	12"	LG-CRCIPS-12-4	
4"	18"	LG-CRCIPS-18-4	
5"	12"	LG-CRCIPS-12-5	
5"	18"	LG-CRCIPS-18-5	
6"	12"	LG-CRCIPS-12-6	
6"	18"	LG-CRCIPS-18-6	
8"	12"	LG-CRCIPS-12-8	
8"	18"	LG-CRCIPS-18-8	
10"	12"	LG-CRCIPS-12-10	
10"	18"	LG-CRCIPS-18-10	
12"	12"	LG-CRCIPS-12-12	
12"	18"	LG-CRCIPS-18-12	
14"	12"	LG-CRCIPS-12-14	
14"	18"	LG-CRCIPS-18-14	
16"	12"	LG-CRCIPS-12-16	
16"	18"	LG-CRCIPS-18-16	

**LITTLE GIANT
FIBERGLASS PIP BOLTED COUPLER - 300 PSI
FIBERGLASS BODY & FLANGES**

Size	Body Length	Part No.	Price
4"	12"	LG-CRCPIP-12-4	
4"	18"	LG-CRCPIP-18-4	
6"	12"	LG-CRCPIP-12-6	
6"	18"	LG-CRCPIP-18-6	
8"	12"	LG-CRCPIP-12-8	
8"	18"	LG-CRCPIP-18-8	
10"	12"	LG-CRCPIP-12-10	
10"	18"	LG-CRCPIP-18-10	
12"	12"	LG-CRCPIP-12-12	
12"	18"	LG-CRCPIP-18-12	
14"	12"	LG-CRCPIP-12-14	
14"	18"	LG-CRCPIP-18-14	
15"	12"	LG-CRCPIP-12-15	
15"	18"	LG-CRCPIP-18-15	
16"	12"	LG-CRCPIP-12-16	
16"	18"	LG-CRCPIP-18-16	

For more Bolted Couplers See Section 2

POWER SEAL HEAVY-DUTY CAST IRON BOLTED TRANSITION COUPLING

This high quality coupler is designed & manufactured for irrigation, municipal & industrial applications. Additional coupler sizes are available upon request. To order, any combination of pipe O.D. ranges can be paired within a nominal pipe size to make a transition connection. Example: to connect 4" IPS steel or PVC (4.50" O.D.) to 4" asbestos cement (5.33" O.D.) order the 3501-4AC coupling.

MODEL 3501 SHORT TRANSITION COUPLING - 6" LENGTH

Part No.	Size	Pipe OD Range	Letter Code	Flanged Color	Bolt Qty	Price
3501-4XX	4"	4.00 - 4.13	OD	White	4	
3501-4XX		4.20 - 4.50	AA	Green		
3501-4XX		4.50 - 4.85	A	Blue		
3501-4XX		4.80 - 5.10	B	Black		
3501-4XX		5.05 - 5.40	C	Grey		
3501-6XX	6"	6.00 - 6.14	OD	White	5	
3501-6XX		6.27 - 6.72	AA	Green		
3501-6XX		6.62 - 6.95	A	Blue		
3501-6XX		6.90 - 7.22	B	Black		
3501-6XX		7.19 - 7.45	C	Grey		
3501-8XX	8"	8.00 - 8.16	OD	White	6	
3501-8XX		8.40 - 8.82	AA	Green		
3501-8XX		8.62 - 9.05	A	Blue		
3501-8XX		9.05 - 9.45	B	Black		
3501-8XX		9.10 - 9.79	C	Grey		
3501-10XX	10"	10.70 - 11.10	A	Blue	7	
3501-10XX		11.10 - 11.50	B	Black		
3501-10XX		11.60 - 12.12	C	Grey		



MODEL 3501 LONG TRANSITION COUPLING - 12" LENGTH

Part No.	Size	Pipe OD Range	Letter Code	Flanged Color	Bolt Qty	Price
3501LB-4XX	4"	4.00 - 4.13	OD	White	4	
3501LB-4XX		4.20 - 4.50	AA	Green		
3501LB-4XX		4.50 - 4.85	A	Blue		
3501LB-4XX		4.80 - 5.10	B	Black		
3501LB-4XX		5.05 - 5.40	C	Grey		
3501LB-6XX	6"	6.00 - 6.14	OD	White	5	
3501LB-6XX		6.27 - 6.72	AA	Green		
3501LB-6XX		6.62 - 6.95	A	Blue		
3501LB-6XX		6.90 - 7.22	B	Black		
3501LB-6XX		7.19 - 7.45	C	Grey		
3501LB-8XX	8"	8.00 - 8.16	OD	White	6	
3501LB-8XX		8.40 - 8.82	AA	Green		
3501LB-8XX		8.62 - 9.05	A	Blue		
3501LB-8XX		9.05 - 9.45	B	Black		
3501LB-8XX		9.10 - 9.79	C	Grey		
3501LB-10XX	10"	10.70 - 11.10	A	Blue	7	
3501LB-10XX		11.10 - 11.50	B	Black		
3501LB-10XX		11.60 - 12.12	C	Grey		



PVC FITTINGS IPS X PIP BOLTED TRANSITION COUPLER 125 PSI PVC BODY & STEEL FLANGES

Part No.	Size	Body Length	Price
PIPGBT002	6"	12"	
PIPGBT052	8"	12"	
PIPGBT102	10"	12"	
PIPGBT152	12"	12"	



PIPE REPAIR CLAMPS

Save time, labor & money by using these high quality repair clamps for repairing above & below ground leaks & broken pipelines. They are NSF approved & manufactured with type 304 stainless steel armor plate & panel, 1/4" thick nitrile (Buna-N NBR) Chek-O-Seal rubber gasket, ductile iron lugs & low alloy steel nuts & bolts. When ordering, specify model number, pipe size with letter code, & width. Example: 6" cast iron O.D. 6.90" with 12" clamp width. Order 3121-6CX12.

POWER SEAL MODEL 3121 IRON LUG SINGLE PANEL PIPE REPAIR CLAMP

Part No.	Pipe Size	Range In.	Letter Code	W = Width				
				8"	12"	16"	20"	24"
3121-1-1/4XW	1-1/4"	1.66	A					
3121-1-1/2XW	1-1/2"	1.88-1.92	B					
3121-2XW	2"	2.35-2.63	A					
3121-2-1/2XW	2-1/2"	2.70-3.00	B					
3121-3AXW	3"	2.97-3.25	A					
3121-3BXW		3.46-3.70	B					
3121-3CXW		3.73-4.00	C					
3121-3DXW		3.96-4.25	D					
3121-4AXW	4"	4.45-4.73	A					
3121-4BXW		4.74-5.14	B					
3121-4CXW		4.95-5.35	C					
3121-4DXW		5.22-5.62	D					
3121-6AXW	6"	5.95-6.35	A					
3121-6BXW		6.56-6.96	B					
3121-6CXW		6.84-7.24	C					
3121-6DXW		7.05-7.45	D					
3121-6EXW		7.45-7.85	E					
3121-8AXW	8"	7.95-8.35	A					
3121-8BXW		8.54-8.94	B					
3121-8CXW		8.99-9.39	C					
3121-8DXW		9.27-9.67	D					
3121-10AXW	10"	9.70-10.10	A					
3121-10BXW		10.64-11.04	B					
3121-10CXW		11.04-11.44	C					
3121-10DXW		11.34-11.74	D					
3121-10EXW		11.75-12.15	E					
3121-12AXW	12"	12.00-12.40	A					
3121-12BXW		12.62-13.02	B					
3121-12CXW		13.10-13.50	C					
3121-12DXW		13.40-13.80	D					
3121-12EXW		13.70-14.10	E					
3121-12FXW		14.00-14.40	F					



NOTE: Stocked widths shown above. 10" & 30" Widths available by special order.

POWER SEAL PIPE REPAIR CLAMP WITH TAPPED OUTLET

To add-on a female iron thread tapped outlet to a repair clamp add the outlet size to the end of the part number. Combine the pipe repair clamp price listed above with the outlet list price add-on listed below for a total list price.

Outlet Size	Min. Pipe OD	Add-On Price
3/4"	2.38	
1"	2.38	
1-1/4"	2.38	

Outlet Size	Min. Pipe OD	Add-On Price
1-1/2"	3.50	
2"	3.50	
3"	6.63	



POWER SEAL MODEL 3141 IRON LUG COLLAR LEAK

Similar to model 3121 pipe repair clamps, but used to provide a simple & permanent repair for leaking solvent weld PVC bells & collars as well as threaded steel pipe collars. These are not recommended for leaking push-on-joint gasketed bells. When ordering, please fill in the blank provided in the part number with the O.D. decimal size of the collar leak that you wish to order.

Part No.	Pipe Size	Pipe O.D. Range Options & Collar Type	8" Width
3141-4. _X8	4"	4.13" PIP 80# Bell or 4.50" Sch. 40 Collar, SDR 26 Bell	
3141-6. _X8	6"	6.14" PIP 80# Bell or 6.63" Sch. 40 Collar, SDR 26 Bell	
3141-8. _X8	8"	8.14" PIP 80# Bell or 8.63" Sch. 40 Collar, SDR 26 Bell	
3141-10. _X8	10"	10.20" PIP 80# Bell or 10.75" Sch. 40 Collar, SDR 26 Bell	
3141-12. _X8	12"	12.24" PIP 80# Bell or 12.75" Sch. 40 Collar, SDR 26 Bell	
3141-15.30X8	15"	15.30" PIP 80# Bell	

NOTE: Specify decimal size in blanks provided to denote required size.

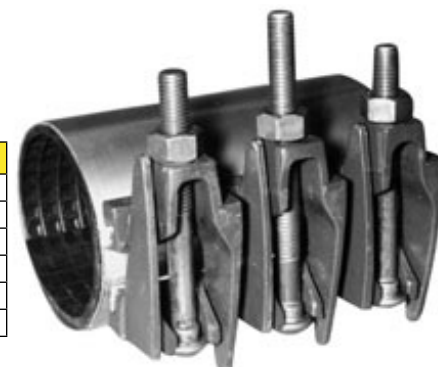

6" WIDE - 2 BOLT FOR IPS PIPE

Part No.	Pipe Size	Box Qty.	Price
330-026	3/8"	3	
330-036	1/2"	3	
330-046	3/4"	3	
330-056	1"	3	
330-066	1-1/4"	3	
330-076	1-1/2"	3	
330-086	2"	2	
330-096	2-1/2"	2	
330-106	3"	2	
330-1056	3-1/2"	1	
330-116	4"	1	
330-126	5"	1	
330-136	6"	1	
330-1356	7"	1	
330-146	8"	1	
330-156	10"	1	
330-166	12"	1	
330-176	14"	1	
330-186	16"	1	
330-196	18"	1	



9" WIDE - 3 BOLT FOR IPS PIPE

Part No.	Pipe Size	Box Qty.	Price
330-029	3/8"	4	
330-039	1/2"	4	
330-049	3/4"	4	
330-059	1"	4	
330-069	1-1/4"	4	
330-079	1-1/2"	3	
330-089	2"	3	
330-099	2-1/2"	1	
330-109	3"	1	
330-1059	3-1/2"	1	
330-119	4"	1	
330-129	5"	1	
330-139	6"	1	
330-1359	7"	1	
330-149	8"	1	
330-159	10"	1	
330-169	12"	1	
330-179	14"	1	
330-189	16"	1	
330-199	18"	1	



12" WIDE - 4 BOLT FOR IPS PIPE

Part No.	Pipe Size	Box Qty.	Price
330-0212	3/8"	4	
330-0312	1/2"	4	
330-0412	3/4"	4	
330-0512	1"	4	
330-0612	1-1/4"	4	
330-0712	1-1/2"	3	
330-0812	2"	3	
330-0912	2-1/2"	2	
330-1012	3"	2	
330-10512	3-1/2"	1	
330-1112	4"	1	
330-1212	5"	1	
330-1312	6"	1	
330-13512	7"	1	
330-1412	8"	1	
330-1512	10"	1	
330-1612	12"	1	
330-1712	14"	1	
330-1812	16"	1	
330-1912	18"	1	



6" WIDE - 2 BOLT FOR O.D. & PIP PIPE

Part No.	Pipe Size	Box Qty.	Price
330-086-OD	2"	2	
330-096-OD	2-1/2"	2	
330-106-OD	3"	2	
330-1056-OD	3-1/2"	1	
330-116-OD	4"	1	
330-126-OD	5"	1	
330-136-OD	6"	1	
330-1356-OD	7"	1	
330-146-OD	8"	1	
330-156-OD	10"	1	
330-166-OD	12"	1	



9" WIDE - 3 BOLT FOR O.D. & PIP PIPE

Part No.	Pipe Size	Box Qty.	Price
330-089-OD	2"	3	
330-099-OD	2-1/2"	1	
330-109-OD	3"	1	
330-1059-OD	3-1/2"	1	
330-119-OD	4"	1	
330-129-OD	5"	1	
330-139-OD	6"	1	
330-1359-OD	7"	1	
330-149-OD	8"	1	
330-159-OD	10"	1	
330-169-OD	12"	1	



12" WIDE - 4 BOLT FOR O.D. & PIP PIPE

Part No.	Pipe Size	Box Qty.	Price
330-0812-OD	2"	3	
330-0912-OD	2-1/2"	2	
330-1012-OD	3"	2	
330-10512-OD	3-1/2"	1	
330-1112-OD	4"	1	
330-1212-OD	5"	1	
330-1312-OD	6"	1	
330-13512-OD	7"	1	
330-1412-OD	8"	1	
330-1512-OD	10"	1	
330-1612-OD	12"	1	



JIFFY CLAMPS HOLE COVER SADDLES

Part No.	Size (OD)	Price
JC280183	4"	
JC280189	4.5"	
JC280341	6"	
JC280347	6.63"	
JC280356	8"	
JC280365	8.63"	
JC280540	10"	
JC280533	10.75"	



FLEXIBLE RUBBER PIPE COUPLING WITH STAINLESS STEEL BANDS

Use with irrigation applications, sub-soil repairs, storm water systems, new installations & residential drainage systems - anywhere pipes connect to pipes!

- FLEXIBLE
- STRONG
- SECURE
- LEAKPROOF



FLEXIBLE RUBBER COUPLINGS

IPS x IPS

Part No.	Size	Price
4560606	1-1/4"	
4560706	1-1/2" x 1-1/4"	
4560707	1-1/2"	
4560807	2" x 1-1/2"	
4560808	2"	
4561007	3" x 1-1/2"	
4561008	3" x 2"	
4561010	3"	
4561107	4" x 1-1/2"	
4561108	4" x 2"	
4561110	4" x 3"	
4561111	4"	
4561212	5"	
4561311	6" x 4"	
4561313	6"	

Note: These couplings are non-pressure rated.

INTRO
 1. ELECTRICAL
 2. PUMP ACC.
 3. HOSE, PE PIPE & ACC.
 4. IPS, PIP PIPE & ACC.
 5. SURFACE
 6. SPRINKLERS
 7. TRAVELER & WHEEL MOVE
 8. PIVOT
 9. TURN
 10. LOW VOLUME
 11. FILTERS
 12. INJECTION
 13. HARDWARE
 INDEX

SECTION 5

Surface Irrigation

CONTENTS

- 5:3 SURFACE IRRIGATION NOTES
- 5:4 POLY PIPE LAYFLAT TUBING
- 5:5 PVC SURFACE PIPE & FITTINGS
- 5:6 PVC SURFACE FITTINGS
- 5:7 IRRIGATION GATES
- 5:8 ALUMINUM ROD SOCK CLIPS & IRRIGATION SOCKS
- 5:9 ALUMINUM PIPE
- 5:10-11 SURGE VALVES
- 5:10 P&R SURGE SYSTEMS
- 5:11 P&R SURGE COMPONENTS
- 5:11 HOLD BANDS & REPAIR SLEEVES
- 5:12 ALUMINUM TWIST LOCK FITTINGS
- 5:13-16 BALL AND SOCKET FITTINGS
- 5:17-21 ALUMINUM RING LOCK FITTINGS
- 5:21 STEEL RING LOCK FITTINGS
- 5:22 BLACK STEEL RING LOCK FITTINGS
- 5:22-25 GALVANIZED STEEL RING LOCK FITTINGS
- 5:26-27 ALUMINUM BAND & LATCH MAINLINE FITTINGS
- 5:27 ALUMINUM BAND & LATCH GATED PIPE COUPLERS
- 5:28-31 ALUMINUM BAND & LATCH LATERAL LINE FITTINGS
- 5:32-33 ALUMINUM BAND & LATCH SOLID SET FITTINGS
- 5:34 BAND & LATCH ASSEMBLY, PARTS & ACCESSORIES
- 5:35-40 GALVANIZED STEEL BAND & LATCH FITTINGS
- 5:41-42 GALVANIZED VALVE OPENERS
- 5:43 GALVANIZED, EPOXY AND ALUMINUM VALVE OPENERS
- 5:44 ALUMINUM VALVE OPENERS
- 5:45-46 VALVE OPENER REPAIR PARTS
- 5:47-48 GALVANIZED STEEL VALVE STUBS
- 5:49 GALVANIZED, EPOXY AND ALUMINUM VALVE STUBS
- 5:49 ALUMINUM VALVE STUBS
- 5:50-51 VALVE STUB REPAIR PARTS
- 5:52-53 ALFALFA VALVES & HYDRANTS
- 5:52 INFURSA ALUMINUM ALFALFA VALVES & HYDRANTS
- 5:52 FRESNO IRON ALFALFA VALVES & ALUMINUM HYDRANTS
- 5:53 WATERMAN IRON ALFALFA VALVES & ALUMINUM HYDRANTS
- 5:54 CONTROL GATES - SLIDE & TOGGLE
- 5:55 CONTROL GATES - DISTRIBUTING
- 5:56 CONTROL GATES
- 5:57-65 GASKETS
- 5:66 GASKETS, O-RINGS & QUAD RINGS
- 5:67 GASKET CROSS REFERENCE



Delta Plastics Poly Pipe

In the tradition of bringing you products of the highest quality and name brand recognition in the industry, we are pleased to offer Delta Plastics Poly Pipe layflat tubing, the original and best thin-wall polyethylene layflat tubing product in the industry. Delta Plastics Poly Pipe is a seamless plastic tube that can be easily attached to any water source, pump or gravity flow, requiring a very low head of water to flow. Maximum pressure in Poly Pipe should not exceed 4 ft. head pressure. Delta Plastics use only the highest grade virgin polyethylene resins and ultraviolet concentrates to produce a superior product that will withstand the sun's harsh ultraviolet rays and perform to levels which meet or exceed industry standards. Poly Pipe is available in a wide selection of sizes and mil thickness. It is primarily used for transporting water from one point to another and as gated pipe for irrigating row crops. A selection of gates, plugs and tools are offered below if your plan is to use Poly Pipe as gated pipe. Whether your use is for transporting water or furrow irrigating, Delta Plastics Poly Pipe offers the lowest initial cost gravity flow water distribution system developed for leveled-to-grade farm land. It is economical and has been proven to save the end user money due to some of the following considerations:

1. Lower material cost in comparison to other piping products
2. Reduces labor cost during set up
3. Eliminates the need for costly main ditch construction
4. Eliminates high siphon tube costs
5. Conserves water which is often lost to deep percolation in unlined main ditch
6. Eliminates open ditch maintenance
7. Allows instant irrigation when needed after installation

The following charts have been constructed to assist you in your selection of Poly Pipe. Please keep in mind, maximum pressure in Poly Pipe should not exceed 4 ft. head pressure, including pressure loss or gain due to field elevation. Contact our office for additional information, including assistance in selecting the right Poly Pipe for your application.

HYDRAULICS INFORMATION

Size	Flow Rate	Loss/100 Ft. in Ft. of Head
5"	135 GPM	0.35
7"	200 GPM	0.15
7"	300 GPM	0.28
9"	400 GPM	0.15
9"	500 GPM	0.23
9"	600 GPM	0.33
10"	700 GPM	0.24
10"	800 GPM	0.32
12"	750 GPM	0.14
12"	1000 GPM	0.20
12"	1200 GPM	0.27
15"	1200 GPM	0.09
15"	1500 GPM	0.15
15"	2000 GPM	0.22
18"	2500 GPM	0.15
18"	3000 GPM	0.20

DISCHARGE RATE

Hole Size	Gallons Per Minute
1/2"	2
3/4"	5
1"	9
1-1/2"	21
2"	37

RATE OF OUTLET FLOW DISCHARGE BASED ON 15" PIPE AT 6 IN. OF HEAD

POLY PIPE PRICES

Size & Mil Thickness	Ft. Per Roll	Price Per Roll
5" 6 MIL	500'	
7" 7 MIL	1320'	
7" 10 MIL	1320'	
9" 7 MIL	1320'	
9" 10 MIL	1320'	
10" 7 MIL	1320'	
10" 10 MIL	1320'	
12" 7 MIL	1320'	
12" 10 MIL	1320'	
15" 7 MIL	1320'	
15" 10 MIL	1320'	
18" 10 MIL	1320'	
22" 10 MIL	1320'	



NOTE: 12", 15" & 18" POLY PIPE TUBING IS AVAILABLE IN 670FT. ROLL LENGTHS BY SPECIAL ORDER DURING PRESEASON.

PRICE NOTE: DUE TO UNSTABLE POLYETHELENE RESIN PRICES, WE ASK THAT YOU PLEASE CALL US PRIOR TO QUOTING TO VERIFY CURRENT PRICES.



SINGLE LIP HOLE PLUGS

Part No.	Description	Case Qty.	Price
P1	3/4" to 1" Hole	2500	
P125	1-1/4" Hole	1000	
P150	1-1/2" Hole	1000	
P175	1-3/4" Hole	1000	
P200	2" Hole	600	



DOUBLE LIP HOLE PLUGS

Part No.	Description	Case Qty.	Price
PDD	1/2" - 5/8" Hole	1000	
PDC	3/4" - 1" Hole	1000	
PDB	1-1/4" Hole	1000	
PDA	1-1/2" Hole	1000	



GATES AND TOOLS

Part No.	Description	Case Qty.	Price
PSG2.5	Poly Slide Gate 2-1/2"	100	
PSGT	Poly Slide Gate Tool	-	
TOOLHBLUE	Double Hole Cutter, Punches 1-1/16" Hole & 1-3/8" Hole	-	
TOOLHRED	Double Hole Cutter, Punches 5/8" Hole & 7/8" Hole	-	

PVC PLAIN & GATED SURFACE PIPE - GASKET END

22 PSI - WHITE - GASKET END - 30 FT. LENGTH

Part No.	Size	Nominal O.D.	Nominal I.D.	Lbs. / 100'	Ft. / Joint	Pieces / Lift	Feet / Lift
L06000030G	6"	6.00"	5.82"	118	30'	28 / 32	840' / 960'
L08000030G	8"	8.00"	7.80"	175	30'	18	540'
L10000030G	10"	10.00"	9.78"	237	30'	12 / 15	360' / 450'



**Please Call
for Pricing**

Gate spacing options: 20", 24", 30", 36", 40"

PVC SURFACE FITTINGS

FEMALE REPAIR END - G X SOC

Part No.	Size	Price
SURGFE001	6"	
SURGFE051	8"	
SURGFE101	10"	
SURGFE151	12"	



MALE REPAIR END - SOC X SPIG

Part No.	Size	Price
SURSMA001	6"	
SURSMA051	8"	
SURSMA101	10"	
SURSMA151	12"	



11° ELBOW - G X SPIG

Part No.	Size	Price
SURGEL005	6"	
SURGEL065	8"	
SURGEL115	10"	
SURGEL165	12"	



22° ELBOW - G X SPIG

Part No.	Size	Price
SURGEL009	6"	
SURGEL066	8"	
SURGEL116	10"	
SURGEL166	12"	



45° ELBOW - G X SPIG

Part No.	Size	Price
SURGEL017	6"	
SURGEL067	8"	
SURGEL117	10"	
SURGEL167	12"	



90° ELBOW - G X SPIG

Part No.	Size	Price
SURGEL025	6"	
SURGEL075	8"	
SURGEL125	10"	
SURGEL175	12"	



LINE TEE - G X SPIG X G

Part No.	Size	Price
SURGTE001	6"	
SURGTE052	8"	
SURGTE102	10"	
SURGTE152	12"	



FIELD TEE - G X G X SPIG

Part No.	Size	Price
SURGTE002	6"	
SURGTE053	8"	
SURGTE103	10"	
SURGTE153	12"	



INTRO
 1. ELECTRICAL
 2. PUMP ACC.
 3. HOSE, PE PIPE & ACC.
 4. IPS, PIP PIPE & ACC.
 5. SURFACE
 6. SPRINKLERS
 7. TRAVELER & WHEEL MOVE
 8. PIVOT
 9. TURN
 10. LOW VOLUME
 11. FILTERS
 12. INJECTION
 13. HARDWARE
 INDEX

PVC SURFACE FITTINGS

INCREASER - SPIG X G

Part No.	Size	Price
SURGIN001	6" x 8"	
SURGIN051	8" x 10"	
SURGIN101	10" x 12"	



REDUCER - SPIG X G

Part No.	Size	Price
SURGRE052	8" x 6"	
SURGRE102	10" x 8"	
SURGRE152	12" x 10"	



PLUG WITH HOLDER - SPIG

Part No.	Size	Price
SURSPL002	6"	
SURSPL052	8"	
SURSPL102	10"	
SURSPL152	12"	



PLUG - SPIG

Part No.	Size	Price
SURSPL001	6"	
SURSPL051	8"	
SURSPL101	10"	
SURSPL151	12"	



SURFACE CAP - SOC

Part No.	Size	Price
SURSCA001	6"	
SURSCA051	8"	
SURSCA101	10"	
SURSCA151	12"	



SURFACE GASKET

Part No.	Size	Price
SURGAS001	6"	
SURGAS051	8"	
SURGAS101	10"	
SURGAS151	12"	



COUPLER - SOC X SOC

Part No.	Size	Price
SURSCO001	6"	
SURSCO051	8"	
SURSCO101	10"	
SURSCO151	12"	



BUTTERFLY LINE VALVE - G X SPIG

Part No.	Size	Price
SURGBF001	6"	
SURGBF051	8"	
SURGBF101	10"	
SURGBF151	12"	



PIPE EXTENSION - G X SPIG

Part No.	Size	Price
SURGPI002	6" x 3"	
SURGPI003	6" x 5"	
SURGPI052	8" x 3"	
SURGPI053	8" x 5"	
SURGPI102	10" x 3"	
SURGPI103	10" x 5"	
SURGPI152	12" x 3"	
SURGPI153	12" x 5"	



GATES FOR PVC SURFACE PIPE

DAM GATE™

Part No.	Size	Case Qty.	Price
T11080	6"	200	
T11081	8" - 10"	200	



DAM GATE™ PARTS & INSTALLATION TOOL

Part No.	Size	Description	Price
T11082	ANY	Plastic Top	
T11086	6"	Bottom Gasket	
T11083	8" - 10"	Bottom Gasket	
T11084	ANY	Plastic Clip	
T11061	ANY	Installation Tool	



ROUGHNECK GATE™ RECTANGULAR STYLE

Part No.	Size	Case Qty.	Price
RH200	6"	200	
RH100	8" - 10"	200	



GATES FOR ALUMINUM SURFACE PIPE

BARTOS CONTROL GATES & REPAIR PARTS

Complete Gate Fully Assembled		Size	Repair Kit Center, Handle & Screw	
Part No.	Price		Part No.	Price
ACG200		2"	RK200	
ACG250		2-1/2"	RK250	
ACG300		3"	RK300	

Repair Center		Size	Repair Handle	
Part No.	Price		Part No.	Price
RKC200		2"	RKH200	
RKC250		2-1/2"	RKH250	
RKC300		3"	RKH300	
		Screw	RKS000	

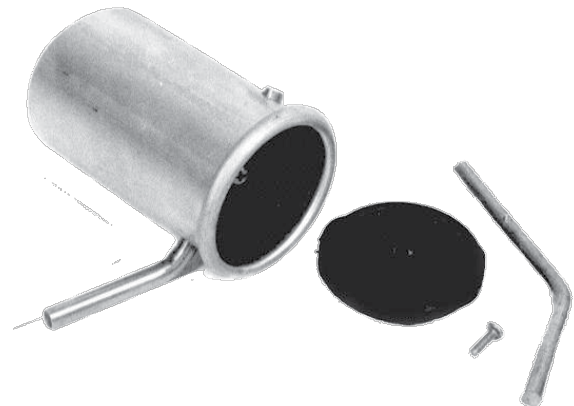

INTRO | 1. ELECTRICAL | 2. PUMP ACC. | 3. HOSE, PE PIPE & ACC. | 4. IPS, PIP PIPE & ACC. | 5. SURFACE | 6. SPRINKLERS | 7. TRAVELER & WHEEL MOVE | 8. PIVOT | 9. TURN | 10. LOW VOLUME | 11. FILTERS | 12. INJECTION | 13. HARDWARE | INDEX

ALUMINUM ROD SOCK CLIPS & IRRIGATION SOCKS

ALUMINUM ROD SOCK CLIPS

ALUMINUM ROD SOCK CLIPS FOR GATED PIPE

PLEASE SPECIFY TYPE OF CLIP AT END OF PART NUMBER: HC OR HO

Part No.	Type of Clip	Size	Package Quantities	Price
SXC6__	HC = Handle Close HO = Handle Offset	6"	10 Clips Per Bundle 100 Clips Per Case	
SXC8__		8"		
SXC10__		10"		
SXC12__		12"		

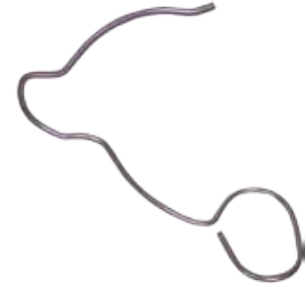

SOCK MATERIAL AND SOCKS

Irrigation socks are used to control soil erosion by dispersing the stream of water over a wider area through the sock. Socks are sized diameter x length & all lengths are "cut length" prior to sewing the cuff or splicing. All 4" socks have a rod cuff sewn in the sock so that they can be used with the aluminum rod clip for gated pipe. Other diameter or length socks are available by special order. Please allow a few days for production.

SOCK MATERIAL - ROLL LENGTH

Part No.	Size	Length	Description	Price
SX2550MR	2-1/2"	50'	Vinyl Mesh, Roll	
SX25100MR	2-1/2"	100'	Vinyl Mesh, Roll	
SX2550BR	2-1/2"	50'	Brown/Black	
SX25100BR	2-1/2"	100'	Brown/Black	



ONE PIECE SOCKS

Part No.	Size	Length	Description	Price
SX212MC	2"	12"	Vinyl Mesh, Closed End	
SX2518MO	2-1/2"	18"	Vinyl Mesh, Open End	
SX2518MC	2-1/2"	18"	Vinyl Mesh, Closed End	
SX2518BO	2-1/2"	18"	Brown/Black Mesh, Open End	
SX2518BC	2-1/2"	18"	Brown/Black Mesh, Closed End	
SX420MO	4"	20"	Vinyl Mesh, Open End	
SX420MC	4"	20"	Vinyl Mesh, Closed End	
SX436N	4"	36"	Neoprene Sleeve, Open End	
SX436V	4"	36"	Vinyl Sleeve, Open End	



TWO PIECE SOCKS

Part No.	Size	Length	Description	Price
SX440NO	4"	40"	Neoprene x Vinyl Mesh, Open End	
SX440NC	4"	40"	Neoprene x Vinyl Mesh, Closed End	
SX440VO	4"	40"	Vinyl x Vinyl Mesh, Open End	
SX440VC	4"	40"	Vinyl x Vinyl Mesh, Closed End	
SX440NCB	4"	40"	Neoprene x Brown Mesh, Closed End	
SX440VCB	4"	40"	Vinyl x Brown Mesh, Closed End	



LARGE DITCH SOCKS

Part No.	Size	Length	Description	Price
SX610D	6"	10'	Vinyl Mesh w / Cuff	
SX810D	8"	10'	Vinyl Mesh w / Cuff	
SX1010D	10"	10'	Vinyl Mesh w / Cuff	
SX1210D	12"	10'	Vinyl Mesh w / Cuff	

ALUMINUM TUBING PRODUCTS



CIRCLE LOCK MAINLINE WITH ALUMINUM WELDED COUPLERS

4 & 6" MAINLINE CIRCLE LOCK

Part No.	Description	Price
045030CLCM	4" x 30' Plain .050 Circle Lock	 Please Call for Pricing
045040CLCM	4" x 40' Plain .050 Circle Lock	
065030CLCM	6" x 30' Plain .050 Circle Lock	
065040CLCM	6" x 40' Plain .050 Circle Lock	
065050CLCM	6" x 50' Plain .050 Circle Lock	
065830CLCM	6" x 30' Plain .058 Circle Lock	
065840CLCM	6" x 40' Plain .058 Circle Lock	
065850CLCM	6" x 50' Plain .058 Circle Lock	
TRAVIS HEAT TREATED		
065830CLTR	6" x 30' Plain .058 Circle Lock	
065840CLTR	6" x 40' Plain .058 Circle Lock	

8" MAINLINE CIRCLE LOCK

Part No.	Description	Price
085030CLCM	8" x 30' Plain .050 Circle Lock	 Please Call for Pricing
085040CLCM	8" x 40' Plain .050 Circle Lock	
085050CLCM	8" x 50' Plain .050 Circle Lock	
086430CLCM	8" x 30' Plain .064 Circle Lock	
086440CLCM	8" x 40' Plain .064 Circle Lock	
086450CLCM	8" x 50' Plain .064 Circle Lock	
TRAVIS HEAT TREATED		
086430CLTR	8" x 30' Plain .064 Circle Lock	
086440CLTR	8" x 40' Plain .064 Circle Lock	

10" MAINLINE CIRCLE LOCK

Part No.	Description	Price
105030CLCM	10" x 30' Plain .050 Circle Lock	 Please Call for Pricing
105040CLCM	10" x 40' Plain .050 Circle Lock	
105050CLCM	10" x 50' Plain .050 Circle Lock	
106430CLCM	10" x 30' Plain .064 Circle Lock	
106440CLCM	10" x 40' Plain .064 Circle Lock	
106450CLCM	10" x 50' Plain .064 Circle Lock	
TRAVIS HEAT TREATED		
106430CLTR	10" x 30' Plain .064 Circle Lock	
106440CLTR	10" x 40' Plain .064 Circle Lock	

12" MAINLINE CIRCLE LOCK

Part No.	Description	Price
126430CLCM	12" x 30' Plain .064 Circle Lock	 Please Call for Pricing
126440CLCM	12" x 40' Plain .064 Circle Lock	
126450CLCM	12" x 50' Plain .064 Circle Lock	
TRAVIS HEAT TREATED		
126430CLTR	12" x 30' Plain .064 Circle Lock	Please Call for Pricing
126440CLTR	12" x 40' Plain .064 Circle Lock	

Available with steel press on couplers.

PLAIN TUBING ONLY (NO COUPLERS)

Size	Thickness	Weight / Ft.	Bundle Qty	Price
2"	0.050	0.36	105	 Please Call for Pricing
3"	0.050	.545	135	
3"	0.065	.071	135	
4"	0.050	.073	81	
4"	0.072	1.05	81	
5"	0.050	0.95	43	
5"	0.078	1.42	43	
6"	0.050	1.12	38/33	
6"	0.058	1.27	38/33	
6"	0.083	1.84	38/33	
7"	0.060	1.55	28	
8"	0.050	1.50	28/23	
8"	0.064	1.88	28/23	
8"	0.072	2.11	28/23	
8"	0.090	2.78	28/23	
9"	0.050	1.75	28	
9"	0.064	2.24	28	
10"	0.050	1.91	14/11	
10"	0.064	2.38	14/11	
10"	0.094	3.44	14/11	
12"	0.064	2.83	11/9	
12"	0.090	3.96	11/9	

BAND & LATCH MAINLINE WITH ALUMINUM WELD-ON HASTINGS COUPLERS

MAINLINE BAND & LATCH

Part No.	Description	Price
06503000BL	6" x 30' Plain .050 Band & Latch	 Please Call for Pricing
06504000BL	6" x 40' Plain .050 Band & Latch	
06583000BL	6" x 30' Plain .058 Band & Latch	
06584000BL	6" x 40' Plain .058 Band & Latch	
08503000BL	8" x 30' Plain .050 Band & Latch	
08504000BL	8" x 40' Plain .050 Band & Latch	
08643000BL	8" x 30' Plain .064 Band & Latch	
08644000BL	8" x 40' Plain .064 Band & Latch	
10503000BL	10" x 30' Plain .050 Band & Latch	
10504000BL	10" x 40' Plain .050 Band & Latch	
10643000BL	10" x 30' Plain .064 Band & Latch	
10644000BL	10" x 40' Plain .064 Band & Latch	

Available with steel press-on couplers.

BAND & LATCH HAND MOVE WITH STEEL PRESS-ON PIERCE TYPE COUPLERS

HANDMOVE BAND & LATCH PIERCE TYPE COUPLER

Part No.	Description	Price
02502000HM	2" x 20' .050 Handmove	 Please Call for Pricing
02503000HM	2" x 30' .050 Handmove	
02504000HM	2" x 40' .050 Handmove	
03502000HM	3" x 20' .050 Handmove	
03503000HM	3" x 30' .050 Handmove	
03504000HM	3" x 40' .050 Handmove	
04502000HM	4" x 20' .050 Handmove	
04503000HM	4" x 30' .050 Handmove	
04504000HM	4" x 40' .050 Handmove	
Mainline band & latch pierce press-on type		
TU0450	4" x 20' .050 Mainline w/ Hold Band	Please Call for Pricing
TU0450	4" x 30' .050 Mainline w/ Hold Band	
TU0450	4" x 40' .050 Mainline w/ Hold Band	

Available with aluminum weld-on couplers.

INTRO 1. ELECTRICAL 2. PUMP Acc. 3. HOSE, PE PIPE & Acc. 4. FPS, PIP Pipe & Acc. 5. SURFACE 6. SPRINKLERS 7. TRAVELER & WHEEL MOVE 8. PIVOT 9. TURF 10. LOW VOLUME 11. FILTERS 12. INJECTION 13. HARDWARE INDEX

P&R SURGE SYSTEMS

Surge transforms flood irrigation into a precision water and fertilizer management system. It delivers water and chemicals to your crop uniformly with up to 85% efficiency. Surge will minimize or eliminate runoff. It will reduce your water, labor and fertilizer costs 25% or more while helping to maximize yields across the entire field, including the corners.

Timing your surge cycles is the key to maximizing your water use. With surge you can water twice the acres in the same time with the same amount of water simply by cycling your water left and right automatically. P&R surge controllers cycle the water in 2 phases: Advance & Soak. Advance is the time needed to cycle water left and right until it reaches the end of the field on both sides. The water recedes into

the furrow between each cycle, partially sealing the furrow to speed up advance. During this phase, the cycle time speeds up automatically to push the water out uniformly. The total advance time can be changed anytime during the irrigation.

Soak cycles begin automatically when the advance phase is complete. The soak cycles are shortened to let the water reach the end of the furrows and control runoff. Soaking adds inches to the already uniform wetted profile. The soak cycle can be fine tuned anytime.

Fertigation with surge is inexpensive, convenient and very efficient for applying nitrogen in surface irrigation. Surging can cut the cost of fertilizing by 40%, deliver a 12% or more increase in yield and keep the plant nutrients in the root zone.

CONTINUOUS FLOOD

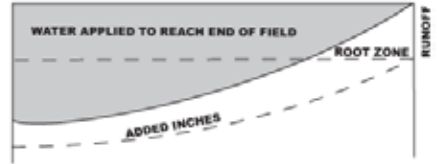

Water is lost below the roots and as runoff.

SURGE IRRIGATION

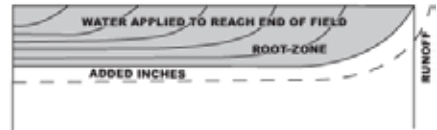

Uniform cycles use less water and control runoff.



STAR CONTROLLER WITH VALVE

Part No.	Valve Size	Maximum Flow	Price
CSTV6	6"	700 GPM	
CSTV8	8"	1200 GPM	
CSTV10	10"	2000 GPM	
CSTV12	12"	2600 GPM	

Star Controller Features:

- Simple, single function keys for setting
- Easy to read constant read out display
- English or Spanish key for read display
- Manual "change side" key for directing water
- Setting for different % of water left & right
- Constant display of total running time and time until next change
- Display of all cycle times in program on demand
- Timer for startup or mid-watering pause
- Solar powered, battery voltage readout
- Adjustable setting for side change speed
- Allows for automatic fertigation

PRO JR. III CONTROLLER WITH VALVE

Part No.	Valve Size	Maximum Flow	Price
PJIIIV6	6"	700 GPM	
PJIIIV8	8"	1200 GPM	
PJIIIV10	10"	2000 GPM	
PJIIIV12	12"	2600 GPM	

PRO JR. III Controller Features:

- Rotary switches to select automatic advance, manual settings and to adjust automatic soak cycles to avoid runoff
- Red flashing LED to indicate program is running
- Manual "change side" toggle switch for directing water

SURGE FERTIGATION PUMP

Part No.	Price
128	
Chemigation Program Add-on for old Star Controller	

Surge Fertigation Pump Features:

- Use with Star Controller
- Simply enter the total number of gallons of fertilizer to apply and the Star Controller will figure the dosing rate and the minimum time needed for application, and will dose fertilizer in a series of soak cycles plus 2 flush cycles.

SURGE VALVES

P&R SURGE COMPONENTS

P&R VALVES

P&R has four valve sizes including a 6", 8", 10" and 12". The valves are T shaped, cast aluminum bodied which acts as a flow diverter by taking water into the inlet port and diverting it to either the left or right outlet ports by means of a motorized butterfly valve. The butterfly valve is activated by a motor contained inside the controller. All valves have a male inlet port and female ports at the two discharge ends. All valves are designed to be used at low pressures, not to exceed 15PSI. All valves perform well with aluminum pipe, PVC pipe or poly pipe.



VALVES ONLY

Part No.	Valve Size	Maximum Flow	Price
V6	6"	700 GPM	
V8	8"	1200 GPM	
V10	10"	2000 GPM	
V12	12"	2600 GPM	

P&R CONTROLLERS

Both Star & Pro Jr. III controllers can be used on any size valve. All controllers have a cast aluminum housing. The housing contains a microprocessor, motor, rechargeable battery and a solar panel. The 12 volt motor delivers 90 in. lbs. torque to drive the gear on each valve. The 12 volt battery has approximately a 3 year life, and when fully charged can keep the unit operating for 14 days with no input from the solar panel. The custom designed solar panel is one watt and with four hours of peak sunlight it provides twenty-four hours of operation. These controllers are energy self sufficient.

Both models feature one number easy set programming:

- Enter one number to automatically set a program that figures how many cycles and how long each will run to get water across the field most efficiently and uniformly.
- The program automatically shortens cycle times for soaking without runoff once the water has advanced across the field.
- The number set can be changed mid-watering and will automatically correct all cycles to fine tune the program.
- Simple off-on restarts the program held in memory.

CONTROLLERS ONLY

Part No.	Description	Price
CST	STAR	
PJIII	ProJr.III	



HOLD BANDS & REPAIR SLEEVES



STEEL HOLD BANDS

Part No.	Size	Price
SHB-4	4"	
SHB-5	5"	
SHB-10	10"	
SHB-12	12"	

ALUMINUM HOLD BANDS

Part No.	Size	Price
HB-300	3"	
HB-400	4"	
HB-500	5"	
HB-600	6"	
HB-800	8"	
HB-1000	10"	
HB-1200	12"	

STEEL REPAIR SLEEVE

Part No.	Size	Price
SRS300L	3"	
SRS400L	4"	
SRS500L	5"	
SRS600	6"	
SRS700	7"	
SRS800	8"	
SRS1000	10"	

Approx. 10" Length

INTRO
 1. ELECTRICAL
 2. PUMP Acc.
 3. HOSE, PE PIPE & Acc.
 4. IPS, PIP PIPE & Acc.
 5. SURFACE
 6. SPRINKLERS
 7. TRAVELER & WHEEL MOVE
 8. PIVOT
 9. TURF
 10. LOW VOLUME
 11. FILTERS
 12. INJECTION
 13. HARDWARE
 INDEX

HIGH PRESSURE ALUMINUM TWIST LOCK FITTINGS

WELD-ON TWIST LOCK COUPLER

Part No.	Size	Price
*TL600	6" Coupler Set	
TLF600	6" Female Only	
TLM600	6" Male End Ring	
TLMF600	6" Male End Full	
TLG	6" Gasket	

* Includes Female & Ring Type Male.



DISCHARGE ADAPTER (GALVANIZED, STEEL)

Part No.	Size	Price
TLSDA-404	4" Mipt x 4" Fem.	
TLSDA-406	4" Mipt x 6" Fem.	
TLSDA-506	5" Mipt x 6" Fem.	
TLSDA-606	6" Mipt x 6" Fem.	



LINE TEE

Part No.	Size	Price
IK212106	6"	



END TEE

Part No.	Size	Price
IK213106	6"	



90° ELBOW

Part No.	Size	Price
IK214106	6"	



45° ELBOW

Part No.	Size	Price
IK215106	6"	



END PLUG

Part No.	Size	Price
IK217106	6"	



BAUER STYLE FITTINGS

S1 GALVANIZED WELD ON STEEL BALL (MALE)

Part No.	Description	Price
1010132	2" Ball	
1090132	3" Ball	
1050132	4" Ball	
1100132	5" Ball	
1070132	6" Ball	
1080132	8" Ball	



S2 GALVANIZED STEEL LEVER (CLOSURE RING)

Part No.	Description	Price
1010134	2" Closure Lever	
1030134	3" Closure Lever	
1050134	4" Closure Lever	
1060134	6" Closure Lever	
1080134	8" Closure Lever	
1310134	10" Closure Lever	
1320134	12" Closure Lever	



S3 GALVANIZED STEEL SOCKET WELD ON FEMALE END

Part No.	Description	Price
1010133	2" Socket	
1090133	3" Socket	
1050133	4" Socket	
1100133	5" Socket	
1070133	6" Socket	
1080133	8" Socket	
1310134	10" Socket	



S4 SEALING RING

Part No.	Description	Price
1010140	2" Sealing Ring	
1030140	3" Sealing Ring	
1050140	4" Sealing Ring	
1100140	5" Sealing Ring	
1070140	6" Sealing Ring	
1080140	8" Sealing Ring	
1310140	10" Sealing Ring	
1320140	12" Sealing Ring	



INTRO
1. ELECTRICAL
2. PUMP ACC.
3. HOSE, PE PIPE & ACC.
4. IPS, PIP PIPE & ACC.
5. SURFACE
6. SPRINKLERS
7. TRAVELER & WHEEL MOVE
8. PIVOT
9. TURN
10. LOW VOLUME
11. FILTERS
12. INJECTION
13. HARDWARE
INDEX

BAUER STYLE FITTINGS

S1 BLACK STEEL BALL (WELD ON MALE END)

Part No.	Description	Price
1010182	2" Ball	
1090182	3" Ball	
1050182	4" Ball	
1100182	5" Ball	
1070182	6" Ball	
1080182	8" Ball	
1310182	10" Ball	
1320182	12" Ball	



S2 BLACK STEEL LEVER

Part No.	Description	Price
1010184	2" Lever	
1030184	3" Lever	
1050184	4" Lever	
1100184	5" Lever	
1060184	6" Lever	
1080184	8" Lever	
1310184	10" Steel Ring	
1320184	12" Steel Ring	



S3 BLACK STEEL SOCKET WELD ON FEMALE END

Part No.	Description	Price
1010183	2" Socket	
1090183	3" Socket	
1050183	4" Socket	
1100183	5" Socket	
107083	6" Socket	
1080183	8" Socket	
1310183	10" Socket	
1320183	12" Socket	



S11 GALVANIZED 90° ELBOW MALE X FEMALE

Part No.	Description	Price
1011101	2" 90° Elbow	
1091101	3" 90° Elbow	
1051101	4" 90° Elbow	
1071101	6" 90° Elbow	
1081101	8" 90° Elbow	
1101-10	10" 90° Elbow	
1321101	12" 90° Elbow	



S13 GALVANIZED 45° ELBOW MALE X FEMALE

Part No.	Description	Price
1011301	2" 45° Elbow	
1091301	3" 45° Elbow	
1051301	4" 45° Elbow	
1071301	6" 45° Elbow	
1081301	8" 45° Elbow	
1301-10	10" 45° Elbow	
1321301	12" 45° Elbow	



BAUER STYLE FITTINGS

S21 GALVANIZED SIDE TEE

Part No.	Description	Price
1011701	2" Tee	
1091701	3" Tee	
1051701	4" Tee	
1071701	6" Tee	
1081701	8" Tee	
1701-10	10" Tee	
1701-12	12" Tee	



S27 GALVANIZED END TEE

Part No.	Description	Price
1011901	2" Tee	
1031901	3" Tee	
1051901	4" Tee	
1071901	6" Tee	
1081901	8" Tee	
1901-10	10" Tee	
1901-12	12" Tee	



S70 GALVANIZED FLANGED BALL (FLANGE X MALE)

Part No.	Description	Price
1006970	3" Flange x Ball	
1006987	4" Flange x Ball	
1007005	6" Flange x Ball	
1007003	8" Flange x Ball	
1007010	10" Flange x Ball	
1007012	12" Flange x Ball	



S71 GALVANIZED BALL X FIPT (MALE X FIPT)

Part No.	Description	Price
1010211	2" Ball x FIPT	
1090211	3" Ball x FIPT	
1050211	4" Ball x FIPT	
1070211	6" Ball x FIPT	
1080211	8" Ball x FIPT	



S72 GALVANIZED SOCKET X FIPT

Part No.	Description	Price
1010311	2" Socket x FIPT	
1090311	3" Socket x FIPT	
1050311	4" Socket x FIPT	
1070311	6" Socket x FIPT	
1080311	8" Socket x FIPT	



INTRO
1. ELECTRICAL
2. PUMP ACC.
3. HOSE, PE PIPE & ACC.
4. IPS, PIP PIPE & ACC.
5. SURFACE
6. SPRINKLERS
7. TRAVELER & WHEEL MOVE
8. PIVOT
9. TURN
10. LOW VOLUME
11. FILTERS
12. INJECTION
13. HARDWARE
INDEX

BAUER STYLE FITTINGS

S73 GALVANIZED FLANGED X SOCKET (FEMALE X FEMALE)

Part No.	Description	Price
1006968	3" Flanged x Socket	
1006986	4" Flanged x Socket	
1007004	6" Flanged x Socket	
1007002	8" Flanged x Socket	
1007310	10" Flanged x Socket	
1007312	12" Flanged x Socket	



S74 GALVANIZED BALL X MIPT (MALE X MIPT)

Part No.	Description	Price
1010811	2" Ball x MIPT	
1090820	3" Ball x MIPT	
1050811	4" Ball x MIPT	
1070811	6" Ball x MIPT	
1080810	8" Ball x MIPT	

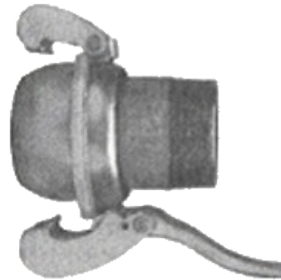

S75 GALVANIZED SOCKET X MIPT (FEMALE X MIPT)

Part No.	Description	Price
1010511	2" Socket x MIPT	
1090521	3" Socket x MIPT	
1050511	4" Socket x MIPT	
1070511	6" Socket x MIPT	
1080511	8" Socket x MIPT	



S77 GALVANIZED HOSE BALL (MALE)

Part No.	Description	Price
1011011	2" Ball x Hose Barb	
1091011	3" Ball x Hose Barb	
1051011	4" Ball x Hose Barb	
1071011	6" Ball x Hose Barb	
1081011	8" Ball x Hose Barb	
1011-10	10" Ball x Hose Barb	
1011-12	12" Ball x Hose Barb	



S78 GALVANIZED HOSE SOCKET (FEMALE)

Part No.	Description	Price
1010711	2" Ball x Hose Barb	
1090711	3" Ball x Hose Barb	
1050711	4" Ball x Hose Barb	
1070711	6" Ball x Hose Barb	
1080711	8" Ball x Hose Barb	
1310711	10" Ball x Hose Barb	
1320711	12" Ball x Hose Barb	



LOW PRESSURE ALUMINUM RING LOCK FITTINGS

50 PSI Maximum

MALE PRESS-ON COUPLER

Part No.	Size	Price
IH101006	6"	
IH101008	8"	
IH101010	10"	
IH101012	12"	



FEMALE PRESS-ON COUPLER

Part No.	Size	Price
IH102006	6"	
IH102008	8"	
IH102010	10"	
IH102012	12"	



MALE WELD-ON COUPLER

Part No.	Size	Price
IH105006	6"	
IH105008	8"	
IH105010	10"	
IH105012	12"	



FEMALE WELD-ON COUPLER

Part No.	Size	Price
IH106006	6"	
IH106008	8"	
IH106010	10"	
IH106012	12"	



WELD-ON SLIP-OVER COUPLER

Part No.	Size	Price
IH106106	6"	
IH106108	8"	
IH106110	10"	



CROSS

Part No.	Size	Price
IH125006	6"	
IH125008	8"	
IH125010	10"	
IH125012	12"	



END TEE

Part No.	Size	Price
IH113006	6"	
IH113008	8"	
IH113010	10"	
IH113012	12"	



LINE / FIELD TEE

Part No.	Size	Price
IH112006	6"	
IH112008	8"	
IH112010	10"	
IH112012	12"	



LEFT LINE / FIELD TEE WITH 2" NIPPLE

Part No.	Size	Price
IH112306L	6"	
IH112308L	8"	
IH112310L	10"	
IH112312L	12"	



RIGHT LINE / FIELD TEE WITH 2" NIPPLE

Part No.	Size	Price
IH112306R	6"	
IH112308R	8"	
IH112310R	10"	
IH112312R	12"	



INTRO | 1. ELECTRICAL | 2. PUMP ACC. | 3. HOSE, PE PIPE & ACC. | 4. IPS, PIP PIPE & ACC. | 5. SURFACE | 6. SPRINKLERS | 7. TRAVELER & WHEEL MOVE | 8. PIVOT | 9. TURF | 10. LOW VOLUME | 11. FILTERS | 12. INJECTION | 13. HARDWARE | INDEX

LOW PRESSURE ALUMINUM RING LOCK FITTINGS

GRADUATED WYE TEE

Part No.	Size	Price
IH119006	6"	
IH119008	8"	
IH119010	10"	
IH119012	12"	



22-1/2° ELBOW

Part No.	Size	Price
IH115306	6"	
IH115308	8"	
IH115310	10"	
IH115312	12"	



45° ELBOW

Part No.	Size	Price
IH115006	6"	
IH115008	8"	
IH115010	10"	
IH115012	12"	



90° ELBOW

Part No.	Size	Price
IH114006	6"	
IH114008	8"	
IH114010	10"	
IH114012	12"	



REDUCER

Part No.	Size	Price
IH11600604	6" x 4"	
IH11600806	8" x 6"	
IH11601008	10" x 8"	
IH11601210	12" x 10"	



INCREASER

Part No.	Size	Price
IH11630406	4" x 6"	
IH11630608	6" x 8"	
IH11630810	8" x 10"	
IH11631012	10" x 12"	



END PLUG

Part No.	Size	Price
IH117006	6"	
IH117008	8"	
IH117010	10"	
IH117012	12"	



END CAP

Part No.	Size	Price
IH117106	6"	
IH117108	8"	
IH117110	10"	
IH117112	12"	



LINE VALVE W/ 1/4" COUPLING

Part No.	Size	Price
IH118006C	6"	
IH118008C	8"	
IH118010C	10"	
IH118012C	12"	



END TEE WITH VALVES

Part No.	Size	Price
IH113306	6"	
IH113308	8"	
IH113310	10"	
IH113312	12"	



HIGH PRESSURE ALUMINUM RING LOCK FITTINGS



WELD-ON COUPLER SET

Part No.	Size	Price
HPRL400	4"	
HPRL500	5"	
HPRL600	6"	
HPRL700	7"	
HPRL800	8"	
HPRL1000	10"	
HPRL1200	12"	



PRESS-ON MAINLINE COUPLER SET

Part No.	Size	Price
RLPSEC500	5"	
RLPSEC600	6"	



WELD-ON FEMALE END

Part No.	Size	Price
HP-F400	4"	
HP-F500	5"	
HP-F600	6"	
HP-F700	7"	
HP-F800	8"	
HP-F1000	10"	
HP-F1200	12"	



PRESS-ON MAINLINE FEMALE END

Part No.	Size	Price
PSEC400	4"	
PSEC500	5"	
PSEC600	6"	



WELD-ON MALE END

Part No.	Size	Price
HP-M400	4"	
HP-M500	5"	
HP-M600	6"	
HP-M700	7"	
HP-M800	8"	
HP-M1000	10"	
HP-M1200	12"	

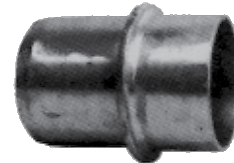

PRESS-ON MAINLINE MALE END

Part No.	Size	Price
PR500	5"	
*PR600	6"	

* Steel Only

INTRO
 1. ELECTRICAL
 2. PUMP ACC.
 3. HOSE, PE PIPE & ACC.
 4. IPS, PIP PIPE & ACC.
 5. SURFACE
 6. SPRINKLERS
 7. TRAVELER & WHEEL MOVE
 8. PIVOT
 9. TURN
 10. LOW VOLUME
 11. FILTERS
 12. INJECTION
 13. HARDWARE
 INDEX

HIGH PRESSURE ALUMINUM RING LOCK FITTINGS



WELD-ON MALE END RING

Part No.	Size	Price
R600	6"	
R800	8"	
R1000	10"	

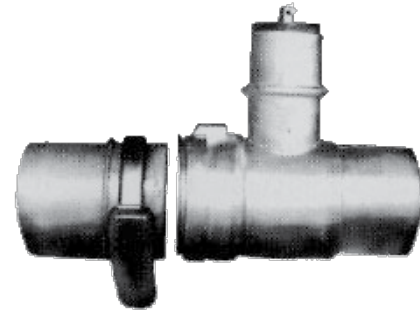

PRESS-ON UNIVERSAL VALVE TEE

Part No.	Size	Price
RLUVT-P554	5" x 5" x 4"	
RLUVT-P664	6" x 6" x 4"	



WELD-ON UNIVERSAL VALVE TEE

Part No.	Size	Price
RLUVT-W554	5" x 5" x 4"	
RLUVT-W664	6" x 6" x 4"	

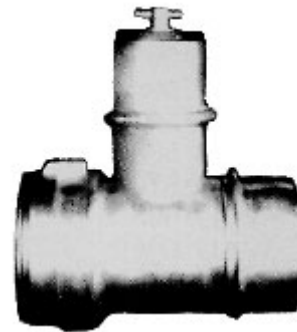

IN-LINE UNIVERSAL VALVE TEE

Part No.	Size	Price
RLUVT-L554	5" x 5" x 4"	
RLUVT-L664	6" x 6" x 4"	

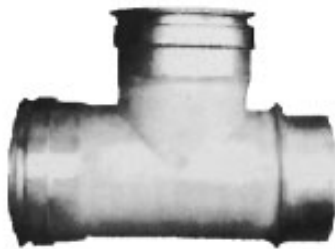

MAINLINE FIELD TEE

Part No.	Size	Price
HPFT400	4"	
HPFT500	5"	
HPFT600	6"	
HPFT700	7"	
HPFT800	8"	
HPFT1000	10"	



MAINLINE END TEE

Part No.	Size	Price
HPET400	4"	
HPET500	5"	
HPET600	6"	
HPET700	7"	
HPET800	8"	
HPET1000	10"	

ALUMINUM RING LOCK FITTINGS

HIGH PRESSURE ALUMINUM RING LOCK FITTINGS

MAINLINE 90° ELBOW

Part No.	Size	Price
HPFE400	4"	
HPFE500	5"	
HPFE600	6"	
HPFE700	7"	
HPFE800	8"	
HPFE1000	10"	



MAINLINE REDUCER

Part No.	Size	Price
HPR405	4" x 5"	
HPR406	4" x 6"	
HPR506	5" x 6"	
HPR607	6" x 7"	
HPR608	6" x 8"	
HPR708	7" x 8"	
HPR8010	8" x 10"	
HPR1012	10" x 12"	



END PLUG

Part No.	Size	Price
HPEP600	6"	
HPEP700	7"	
HPEP800	8"	
HPEP1000	10"	



STEEL RING LOCK FITTINGS

HIGH PRESSURE RING LOCK CLAMPS

PIERCE

Part No.	Size	Price
P2123-08	4"	
P2123-01	5"	
P2123-02	6"	
P2123-03	8"	
P2123-04	10"	
P2123-05	12"	



TRAVIS

Part No.	Size	Price
HPRLC300	3"	
HPRLC400	4"	
HPRLC500	5"	
HPRLC600	6"	
*HPRLC600TL	6"	
HPRLC700	7"	
HPRLC800	8"	
*HPRLC800TL	8"	
HPRLC1000	10"	
HPRLC1200	12"	



* Oversized to fit gated pipe bell couplers.

TRAVIS GALVANIZED SURGE PLUG

Part No.	Size	Price
SRL-SP400	4"	
SRL-SP500	5"	
SRL-SP600	6"	
SRL-SP700	7"	
SRL-SP800	8"	
SRL-SP1000	10"	



BLACK STEEL RING LOCK FITTINGS

WELD-ON MALE STARTER COUPLER

PIERCE

Part No.	Size	Price
P1678-02	4"	
P1676-01	5"	
P1676-02	6"	
P1676-04	8"	
P1676-05	10"	
P1676-06	12"	



TRAVIS

Part No.	Size	Price
SCBM300	3"	
SCBM400	4"	
SCBM500	5"	
SCBM600	6"	
SCBM800	8"	
SCBM1000	10"	
SCBM1200	12"	



WELD-ON FEMALE STARTER COUPLER - STANDARD PUNCH

PIERCE

Part No.	Size	Price
P1669-42	4"	
P1669-44	6"	
P1669-46	8"	
P1669-47	10"	
P1669-48	12"	



TRAVIS

Part No.	Size	Price
SCB200	2"	
SCB300	3"	
SCB400	4"	
SCB500	5"	
SCB600	6"	
SCB800	8"	
SCB1000	10"	
SCB1200	12"	



WELD-ON FEMALE STARTER COUPLER - DEEP PUNCH

PIERCE

Part No.	Size	Price
P1007-41	2"	
P1007-42	3"	
P1007-43	4"	
P1007-44	5"	
P1007-45	6"	
P1007-47	8"	
P1007-48	10"	
P1007-49	12"	



TRAVIS

Part No.	Size	Price
SCB400D	4"	
SCB500D	5"	
SCB600D	6"	
SCB800D	8"	
SCB1000D	10"	
SCB1200D	12"	



GALVANIZED STEEL RING LOCK FITTINGS

WELD-ON MALE STARTER COUPLER

PIERCE

Part No.	Size	Price
P1678-12	4"	
P1676-11	5"	
P1676-12	6"	
P1676-14	8"	
P1676-15	10"	



TRAVIS

Part No.	Size	Price
SCGM300	3"	
SCGM400	4"	
SCGM500	5"	
SCGM600	6"	
SCGM800	8"	
SCGM1000	10"	
SCGM1200	12"	



GALVANIZED STEEL RING LOCK FITTINGS

WELD-ON FEMALE STARTER COUPLER - STANDARD PUNCH

PIERCE

Part No.	Size	Price
P1669-12	4"	
P1669-14	6"	
P1669-16	8"	
P1669-17	10"	
P1669-18	12"	



TRAVIS

Part No.	Size	Price
SCG200	2"	
SCG300	3"	
SCG400	4"	
SCG500	5"	
SCG600	6"	
SCG800	8"	
SCG1000	10"	
SCG1200	12"	



WELD-ON FEMALE STARTER COUPLER - DEEP PUNCH

PIERCE

Part No.	Size	Price
P1007-53	4"	
P1007-54	5"	
P1007-55	6"	
P1007-57	8"	
P1007-58	10"	
P1007-59	12"	



TRAVIS

Part No.	Size	Price
SCG400D	4"	
SCG500D	5"	
SCG600D	6"	
SCG800D	8"	
SCG1000D	10"	
SCG1200D	12"	



PRESS-ON MAINLINE COUPLER SET

PIERCE

Part No.	Size	Price
P1671-92	4"	
P1671-93	5"	
P1671-94	6"	
P1671-96	8"	
P1671-97	10"	
P1671-98	12"	



TRAVIS

Part No.	Size	Price
SRL300	3"	
SRL400	4"	
SRL500	5"	
SRL600	6"	
SRL700	7"	
SRL800	8"	
SRL1000	10"	
SRL1200	12"	



PRESS-ON FEMALE MAINLINE COUPLER

PIERCE

Part No.	Size	Price
P1671-72	4"	
P1671-73	5"	
P1671-74	6"	
P1671-76	8"	
P1671-77	10"	
P1671-78	12"	



TRAVIS

Part No.	Size	Price
SRL-F300	3"	
SRL-F400	4"	
SRL-F500	5"	
SRL-F600	6"	
SRL-F700	7"	
SRL-F800	8"	
SRL-F1000	10"	
SRL-F1200	12"	

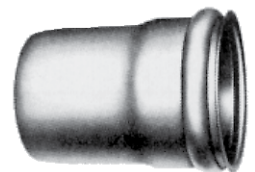

PRESS-ON MALE COUPLER

PIERCE

Part No.	Size	Price
P1677-12	4"	
P1675-12	6"	
P1675-14	8"	
P1675-15	10"	
P1675-16	12"	



TRAVIS

Part No.	Size	Price
SRL-M300	3"	
SRL-M400	4"	
SRL-M500	5"	
SRL-M600	6"	
SRL-M700	7"	
SRL-M800	8"	
SRL-M1000	10"	
SRL-M1200	12"	

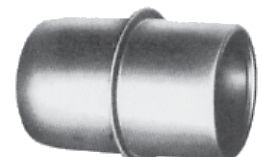

INTRO
 1. ELECTRICAL
 2. PUMP Acc.
 3. HOSE, PE PIPE & Acc.
 4. IPS, PIP Pipe & Acc.
 5. SURFACE
 6. SPRINKLERS
 7. TRAVELER & WHEEL MOVE
 8. PIVOT
 9. TURF
 10. LOW VOLUME
 11. FILTERS
 12. INJECTION
 13. HARDWARE
 INDEX

GALVANIZED STEEL RING LOCK FITTINGS

MALE END RINGS

STEEL WELD RING

Part No.	Size	Price
SWR-4	4"	
SWR-6	6"	
SWR-8	8"	
SWR-10	10"	



TRAVIS - BOLT ON ADJUSTABLE MALE END

Part No.	Size	Price
SRLMBO600	6"	
SRLMBO800	8"	
SRLMBO1000	10"	



45° ELBOW

PIERCE

Part No.	Size	Price
P1799-62	4"	
P1798-61	6"	
P1798-63	8"	
P1798-64	10"	
P1798-65	12"	



TRAVIS

Part No.	Size	Price
SRLFE300-45	3"	
SRLFE400-45	4"	
SRLFE500-45	5"	
SRLFE600-45	6"	
SRLFE800-45	8"	
SRLFE1000-45	10"	
SRLFE1200-45	12"	



90° ELBOW

PIERCE

Part No.	Size	Price
P1796-62	4"	
P1797-61	6"	
P1797-63	8"	
P1797-64	10"	
P1797-65	12"	



TRAVIS

Part No.	Size	Price
SRLFE300	3"	
SRLFE400	4"	
SRLFE500	5"	
SRLFE600	6"	
SRLFE800	8"	
SRLFE1000	10"	
SRLFE1200	12"	



UNIVERSAL MAINLINE TEE TO LATERAL VALVE SET



PIERCE

Part No.	Size	Price
P1761-81	4" x 4" x 4"	
P1761-82	5" x 5" x 4"	
P1761-83	6" x 6" x 4"	
P1761-84	8" x 8" x 4"	
P1761-85	10" x 10" x 4"	
P1761-86	12" x 12" x 4"	



TRAVIS

Part No.	Size	Price
SRLUVT333	3" x 3" x 3"	
SRLUVT444	4" x 4" x 4"	
SRLUVT554	5" x 5" x 4"	
SRLUVT664	6" x 6" x 4"	
SRLUVT884	8" x 8" x 4"	
SRLUVT10104	10" x 10" x 4"	
SRLUVT12124	12" x 12" x 4"	

GALVANIZED STEEL RING LOCK FITTINGS

UNIVERSAL IN-LINE MAINLINE TEE TO LATERAL VALVE

PIERCE

Part No.	Size	Price
P1761-61	4" x 4" x 4"	
P1761-63	6" x 6" x 4"	
P1761-64	8" x 8" x 4"	
P1761-65	10" x 10" x 4"	
P1761-66	12" x 12" x 4"	



TRAVIS

Part No.	Size	Price
SRLUVT-L444	4" x 4" x 4"	
SRLUVT-L554	5" x 5" x 4"	
SRLUVT-L664	6" x 6" x 4"	
SRLUVT-L884	8" x 8" x 4"	
SRLUVT-L10104	10" x 10" x 4"	
SRLUVT-L12124	12" x 12" x 4"	



END TEE

PIERCE

Part No.	Size	Price
P1181-61	4"	
P1181-63	6"	
P1181-65	8"	
P1181-66	10"	
P1181-67	12"	



TRAVIS

Part No.	Size	Price
SRLET300	3"	
SRLET400	4"	
SRLET500	5"	
SRLET600	6"	
SRLET800	8"	
SRLET1000	10"	
SRLET1200	12"	



LINE / FIELD TEE

PIERCE

Part No.	Size	Price
P1504-62	4"	
P1506-64	6"	
P1507-65	8"	
P1509-61	10"	
P1680-67	12"	



TRAVIS

Part No.	Size	Price
SRLFT300	3"	
SRLFT400	4"	
SRLFT500	5"	
SRLFT600	6"	
SRLFT800	8"	
SRLFT1000	10"	
SRLFT1200	12"	



REDUCER - M X F

PIERCE

Part No.	Size	Price
P1838-62	6" x 4"	
P1838-65	8" x 6"	
P1838-66	10" x 8"	
P1838-67	12" x 10"	



TRAVIS

Part No.	Size	Price
SRLR304	4" x 3"	
SRLR405	5" x 4"	
SRLR406	6" x 4"	
SRLR506	6" x 5"	
SRLR608	8" x 6"	
SRLR610	10" x 6"	
SRLR810	10" x 8"	
SRLR1012	12" x 10"	



END PLUG

PIERCE

Part No.	Size	Price
P3206-01	4"	
P3206-03	6"	
P3206-05	8"	
P3206-06	10"	
P3206-07	12"	



TRAVIS

Part No.	Size	Price
SRLEP300	3"	
SRLEP400	4"	
SRLEP500	5"	
SRLEP600	6"	
SRLEP800	8"	
SRLEP1000	10"	
SRLEP1200	12"	



Hose Barbed x Ring Lock Connectors (See Section 3 Page 30)

INTRO 1. ELECTRICAL 2. PUMP Acc. 3. HOSE, PE PIPE & Acc. 4. FPS, PIP Pipe & Acc. 5. SURFACE 6. SPRINKLERS 7. TRAVELER & WHEEL MOVE 8. PIVOT 9. TURF 10. LOW VOLUME 11. FILTERS 12. INJECTION 13. HARDWARE INDEX

TRAVIS A&M MAINLINE FITTINGS

PRESS-IN COUPLER WITH BAND & LATCH ASSEMBLY

Part No.	Size	Price
CX4436	4"	
CX5536	5"	
CX6636	6"	

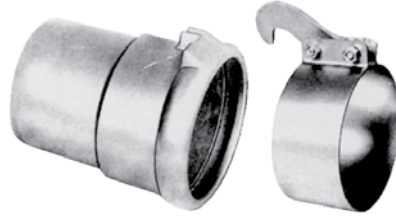

WELD-ON COUPLER WITH BAND & LATCH ASSEMBLY

Part No.	Size	Price
CX3335A	3"	
CX4435A	4"	
CX5535A	5"	
CX6635A	6"	
CX7735A	7"	
CX8835A	8"	
CX1035A	10"	



DETACHABLE COUPLER WITH 2 BAND & LATCH ASSEMBLIES

Part No.	Size	Price
CX3335	3"	
CX4435	4"	
CX5535	5"	
CX6635	6"	
CX7735	7"	
CX8835	8"	
CX1035	10"	

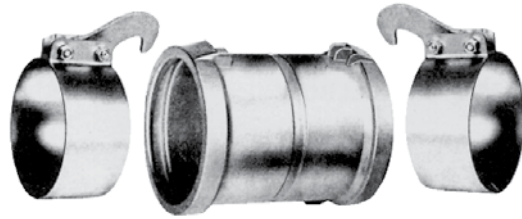

IN-LINE TEE VALVE

Part No.	Size	Price
VT4433M4	4"	
VT5533M4	5"	
VT6633M4	6"	

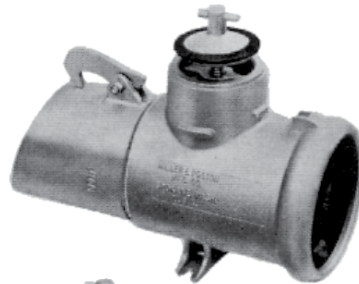

WELD-ON TEE VALVE

Part No.	Size	Price
VTX4433W	4"	
VTX5533W	5"	
VTX6633W	6"	

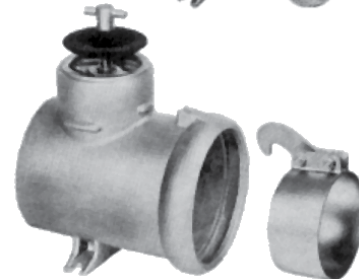

DETACHABLE TEE VALVE

Part No.	Size	Price
VTX4433	4"	
VTX5533	5"	
VTX6633	6"	

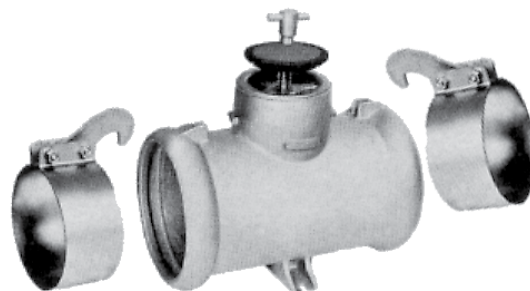

ALUMINUM BAND & LATCH MAINLINE FITTINGS

TRAVIS RAINWAY MAINLINE FITTINGS

PRESS-ON COUPLER WITH BAND & LATCH ASSEMBLY

Part No.	Size	Price
PSECL400	4"	
PSECL500	5"	
PSECL600	6"	



PRESS-ON UNIVERSAL VALVE TEE WITH BAND & LATCH ASSEMBLY

Part No.	Size	Price
UVTL-P333	3" x 3" x 3"	
UVTL-P444	4" x 4" x 4"	
UVTL-P554	5" x 5" x 4"	
UVTL-P664	6" x 6" x 4"	

PRESS-ON COUPLER ONLY

Part No.	Size	Price
PSEC400	4"	
PSEC500	5"	
PSEC600	6"	

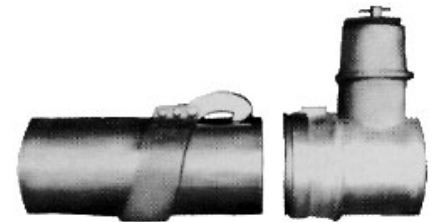

WELD-ON UNIVERSAL VALVE TEE WITH BAND & LATCH ASSEMBLY

Part No.	Size	Price
UVTL-W444	4" x 4" x 4"	
UVTL-W554	5" x 5" x 4"	
UVTL-W664	6" x 6" x 4"	

WELD-ON QUICK LATCH COUPLER WITH BAND & LATCH ASSEMBLY

Part No.	Size	Price
SECL300	3"	
SECL400	4"	
SECL500	5"	
SECL600	6"	
SECL700	7"	
SECL800	8"	
SECL1000	10"	

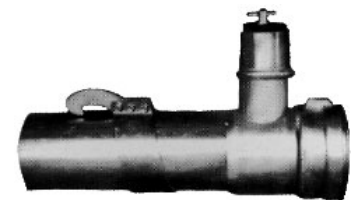

IN-LINE UNIVERSAL VALVE TEE WITH BAND & LATCH ASSEMBLY

Part No.	Size	Price
UVTL-L333	3" x 3" x 3"	
UVTL-L444	4" x 4" x 4"	
UVTL-L554	5" x 5" x 4"	
UVTL-L664	6" x 6" x 4"	

WELD-ON QUICK LATCH COUPLER ONLY

Part No.	Size	Price
SEC300	3"	
SEC400	4"	
SEC500	5"	
SEC600	6"	
SEC700	7"	
SEC800	8"	
SEC1000	10"	



ALUMINUM BAND & LATCH GATED PIPE COUPLERS

WELD-ON RING TYPE COUPLER WITH ROUND BACK GASKET

Part No.	Size	Price
RBC600	6"	
RBC700	7"	
RBC800	8"	
RBC1000	10"	
RBC1200	12"	



WELD-ON RING TYPE COUPLER WITH SQUARE BACK GASKET

Part No.	Size	Price
RC600	6"	
RC800	8"	
RC1000	10"	



TRAVIS A&M LATERAL LINE FITTINGS

PRESS-IN LATERAL COUPLER WITH BAND & LATCH ASSEMBLY

Part No.	Size	Price
CX2234	2"	
CX3334	3"	
CX4434	4"	
CX5534	5"	
CX6634	6"	

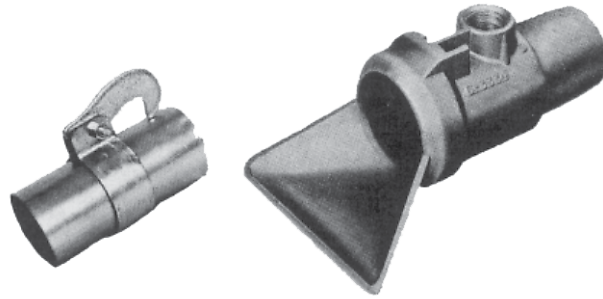

WELD-ON LATERAL COUPLER WITH BAND & LATCH ASSEMBLY

Part No.	Size	Price
CX3334W	3"	
CX4434W	4"	

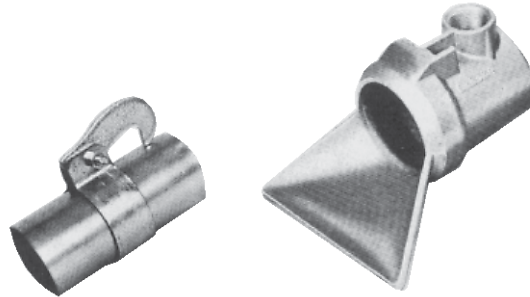

DETACHABLE LATERAL COUPLER WITH 2 BAND & LATCH ASSEMBLIES

Part No.	Size	Price
CX2230	2"	
CX3330	3"	
CX4430	4"	
CX5530	5"	
CX6630	6"	

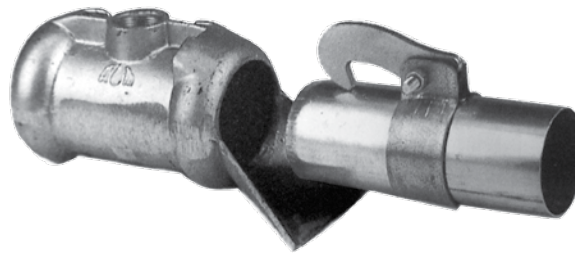

DROP-LOCK LATERAL COUPLER WITH MALE END DROP-LOCK

Part No.	Size	Price
PLCR300	3"	



DISCHARGE ADAPTER

Part No.	Size	Price
D3011/2X2	1-1/2" x 2"	
D3011/2X3	1-1/2" x 3"	
D302X2	2" x 2"	
D302X3	2" x 3"	
D302X4	2" x 4"	
D303X3	3" x 3"	
D303X4	3" x 4"	
D303X5	3" x 5"	
D303X6	3" x 6"	
D304X4	4" x 4"	
D304X5	4" x 5"	
D304X6	4" x 6"	
D305X5	5" x 5"	
D305X6	5" x 6"	
D306X6	6" x 6"	
D306X7	6" x 7"	
D306X8	6" x 8"	

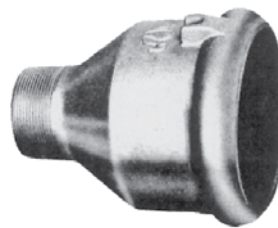

Note: Additional Aluminum Band & Latch Discharge Adapters can be located on page 5:32.

TRAVIS A&M LATERAL LINE FITTINGS

REVERSIBLE 45° MALE-FEMALE ELBOW

Part No.	Size	Price
E2232	2"	
E3332	3"	
E4432	4"	
E5532	5"	
E6632	6"	

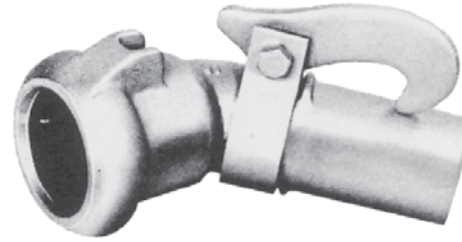

REVERSIBLE 90° MALE-FEMALE ELBOW

Part No.	Size	Price
E2231	2"	
E3331	3"	
E4431	4"	
E5531	5"	
E6631	6"	

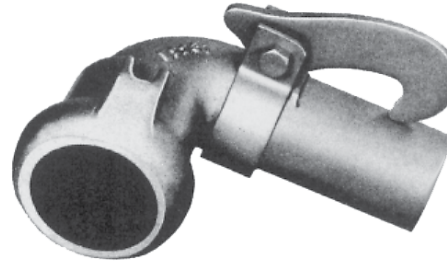

END TEE

Part No.	Size	Price
*FTO200A	2"	
*FTO300A	3"	
*FTO400A	4"	
T55531	5"	
T66631	6"	

*RAINWAY Fitting with A&M Latch.



REVERSIBLE IN-LINE TEE

Part No.	Size	Price
*RFLT200A	2"	
*RFLT300A	3"	
*RFLT400A	4"	
T55532	5"	
T66632	6"	

*RAINWAY Fitting with A&M Latch.

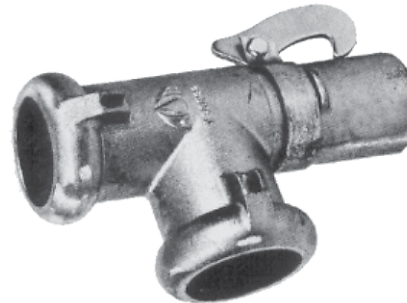

DETACHABLE REDUCER

Part No.	Size	Price
*CR302A	3" x 2"	
*CR403A	4" x 3"	
R5430	5" x 4"	
R6430	6" x 4"	
R6530	6" x 5"	

*RAINWAY Fitting with A&M Latch.

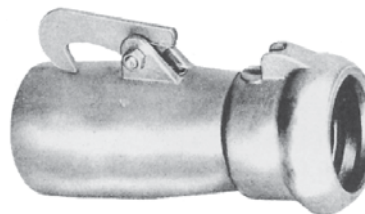

DETACHABLE END PLUG

Part No.	Size	Price
EP20	2"	
EP30	3"	
EP40	4"	

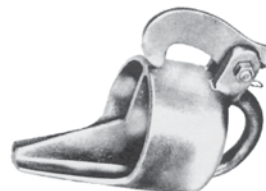

INTRO
1. ELECTRICAL
2. PUMP Acc.
3. HOSE, PE Pipe & Acc.
4. IPS, PIP Pipe & Acc.
5. SURFACE
6. SPRINKLERS
7. TRAVELER & WHEEL MOVE
8. PIVOT
9. TURF
10. LOW VOLUME
11. FILTERS
12. INJECTION
13. HARDWARE
INDEX

TRAVIS RAINWAY LATERAL LINE FITTINGS

PRESS-ON QUICK LATCH COUPLER

Part No.	Size	Price
PSECR200	2"	
PSECR300	3"	
PSECR400	4"	

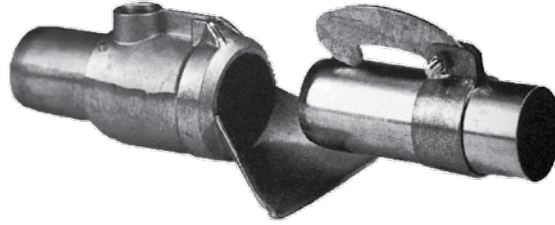

WELD-ON QUICK LATCH COUPLER

Part No.	Size	Price
SECR300	3"	
SECR400	4"	
SECR500	5"	
SECR600	6"	



CLAMP-ON QUICK LATCH COUPLER

Part No.	Size	Price
CLO200	2"	
CLO300	3"	
CLO400	4"	
CLO500	5"	
CLO600	6"	

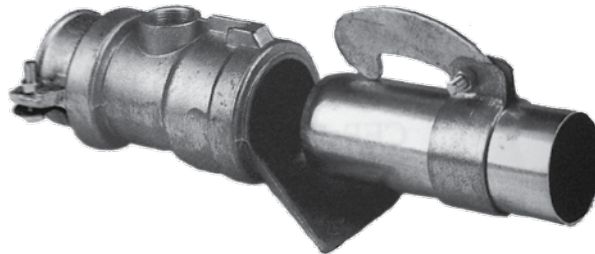

45° REVERSIBLE FIELD ELBOW

Part No.	Size	Price
RFE0200-45	2"	
RFE0300-45	3"	
RFE0400-45	4"	
RFE0500-45	5"	
RFE0600-45	6"	



90° REVERSIBLE FIELD ELBOW

Part No.	Size	Price
RFE0200	2"	
RFE0300	3"	
RFE0400	4"	
RFE0500	5"	
RFE0600	6"	



TRAVIS RAINWAY LATERAL LINE FITTINGS

REVERSIBLE LINE TEE

Part No.	Size	Price
RFLT200	2"	
RFLT300	3"	
RFLT400	4"	
RFLT500	5"	
RFLT600	6"	



FIELD TEE - END TYPE

Part No.	Size	Price
FTO200	2"	
FTO300	3"	
FTO400	4"	
FTO500	5"	
FTO600	6"	



REDUCER

Part No.	Size	Price
CR302	3" x 2"	
CR403	4" x 3"	
CR504	5" x 4"	
CR604	6" x 4"	
CR605	6" x 5"	



RISER GROMMET ASSEMBLY

Part No.	Size	Price
RG300	3"	
RG400	4"	
RG500	5"	
RG600	6"	



END PLUG

Part No.	Size	Price
CEP200	2"	
CEP300	3"	
CEP400	4"	
CEP500	5"	
CEP600	6"	



INTRO
1. ELECTRICAL
2. PUMP ACC.
3. HOSE, PE PIPE & ACC.
4. IPS, PIP PIPE & ACC.
5. SURFACE
6. SPRINKLERS
7. TRAVELER & WHEEL MOVE
8. PIVOT
9. TURN
10. LOW VOLUME
11. FILTERS
12. INJECTION
13. HARDWARE
INDEX

TRAVIS A&M SOLID SET FITTINGS

DROP-LOCK / DRAGLINE TOWABLE COUPLER

Part No.	Size	Price
WDLC300	3"	
WML300	3"	

Weld-On coupler w/ 3/4" outlet, half band & gasket



DROP-LOCK / DRAGLINE TOWABLE COUPLER WITH MALE END

Part No.	Size	Price
WDL-ME-300	3"	
ME-300	3"	

Weld-On coupler w/ 3/4" outlet, gasket & male end



DROP-LOCK / DRAGLINE END PLUG

Part No.	Size	Price
PLC300	3"	

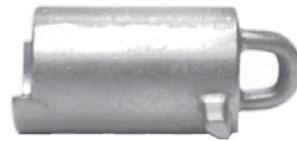

DROP-LOCK / DRAGLINE LATCH ADAPTER

Part No.	Size	Price
LA367	3"	

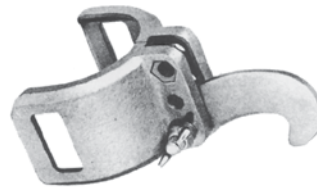

STEEL BOLT-ON CENTER LINE RISER

Part No.	Size	Price
SCR300	3"	
SCR400	4"	



STEEL FOOT FOR BOLT-ON CENTER LINE RISER

Part No.	Size	Price
F30	3"	
F40	4"	



TRAVIS RAINWAY SOLID SET FITTINGS

RAINWAY SOLID SET COUPLER

Part No.	Coupler Size	Outlet Size	Price
PSCS300-100	3"	1"	
PSCS300-075	3"	3/4"	

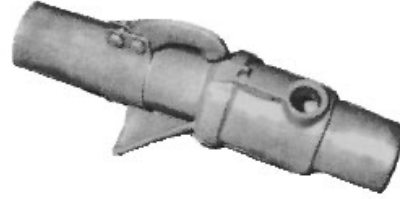

PRESS-ON POSITIVE LOCK COUPLER

Part No.	Size	Price
PLCR200	2"	
PLCR300	3"	
PLCR400	4"	
*PLML200	2"	
*PLML300	3"	
*PLML400	4"	

* Male latch only.



POSITIVE LOCK END PLUG

Part No.	Size	Price
PLC200	2"	
PLC300	3"	
PLC400	4"	



RAIN FOR RENT TYPE WELD-ON COUPLER

Part No.	Size	Price
RFR300W	3"	



PRESS-IN CENTER OUTLET

Part No.	Size	Price
PCR300	3"	
PCR400	4"	

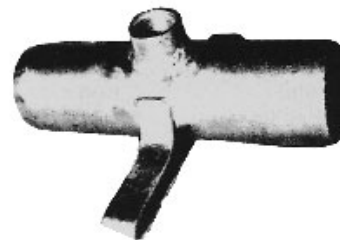

INTRO
1. ELECTRICAL
2. PUMP ACC.
3. HOSE, PE PIPE & ACC.
4. IPS, PIP PIPE & ACC.
5. SURFACE
6. SPRINKLERS
7. TRAVELER & WHEEL MOVE
8. PIVOT
9. TURF
10. LOW VOLUME
11. FILTERS
12. INJECTION
13. HARDWARE
INDEX

BAND & LATCH ASSEMBLY

PIERCE

Part No.	Size	Price
P1034-01	2"	
P1035-01	3"	
P1036-81	4"	
P1036-82	5"	
P1036-83	6"	
P1037-82	8"	



TRAVIS - PIERCE TYPE

Part No.	Size	Price
PBL200	2"	
PBL300	3"	
PBL400	4"	
PBL500	5"	
PBL600	6"	
PBL700	7"	
PBL800	8"	
PBL1000	10"	



TRAVIS RAINWAY

Part No.	Size	Price
RWBL200	2"	
RWBL300	3"	
RWBL400	4"	
RWBL500	5"	
RWBL600	6"	
RWBL700	7"	
RWBL800	8"	



TRAVIS A&M

Part No.	Size	Price
BL200	2"	
BL300	3"	
BL400	4"	
BL500	5"	
BL600	6"	
BL700	7"	
BL800	8"	
BL1000	10"	



PARTS & ACCESSORIES

PIERCE FULL BAND ONLY

Part No.	Size	Price
P1021-01	2"	
P1022-01	3"	
P1023-01	4"	
P1023-02	5"	
P1024-01	6"	
P1026-02	8"	



TRAVIS FULL BAND ONLY

Part No.	Size	Price
B200	2"	
B300	3"	
B400	4"	
B500	5"	
B600	6"	
B700	7"	
B800	8"	
B1000	10"	



PIERCE MISCELLANEOUS PARTS

Part No.	Description	Price
P1012-01	Catch 2" - 4"	
P1012-02	Catch 5" - 8"	
P1027-01	"U" Clevis 1"	
P1028-01	"U" Clevis 2"	
P2028-01	Ferrule	
P2020-05	Bolt 3/8" x 1-1/2"	
P2034-07	Nut 3/8"	
P2042-08	Washer 3/8"	
P2042-11	Washer 9/16"	
P1030-01	Universal Hook	



TRAVIS MISCELLANEOUS PARTS

Part No.	Description	Price
HOOKBOSS-SM	Hookboss-SM	
HOOKBOSS-LG	Hookboss-LG	
HOOKBRKT-SM	"U" Clevis 1"	
HOOKBRKT-LG	"U" Clevis 2"	
FERRULE A	Ferrule 5/16"	
FERRULE B	Ferrule 1/2"	
9401010480	Bolt 3/8" x 1-1/4"	
N1	Nut 3/8"	
PIERCE HOOK	Pierce Type Hook	
201154	Latch Spring	



Contact us for other band & latch fitting brands including:

- Western
- Moore Rane
- Wade Rain
- Felco
- Sure Rane
- Redi Rain

PRESS-ON LATERAL COUPLER SET



PIERCE

Part No.	Size	Outlet	Price
P1016-81	2"	3/4"	
P1898-81	3"	3/4"	
P1016-83	4"	3/4"	
P1016-86	2"	1"	
P1898-82	3"	1"	
P1016-88	4"	1"	
P3280-92	3"	-	



TRAVIS

Part No.	Size	Outlet	Price
BLCR200-075	2"	3/4"	
BLCR300-075	3"	3/4"	
BLCR400-075	4"	3/4"	
BLCR200	2"	1"	
BLCR300	3"	1"	
BLCR400	4"	1"	

PRESS-ON LATERAL FEMALE COUPLER



PIERCE

Part No.	Size	Outlet	Price
P1016-61	2"	3/4"	
P1898-61	3"	3/4"	
P1016-63	4"	3/4"	
P1016-66	2"	1"	
P1898-62	3"	1"	
P1016-68	4"	1"	
P3280-72	3"	-	



TRAVIS

Part No.	Size	Outlet	Price
BLCR200K-075	2"	3/4"	
BLCR300K-075	3"	3/4"	
BLCR400K-075	4"	3/4"	
BLCR200K	2"	1"	
BLCR300K	3"	1"	
BLCR400K	4"	1"	

PRESS-ON MAINLINE COUPLER SET



PIERCE

Part No.	Size	Price
P1014-92	3"	
P1014-93	4"	
P1014-95	6"	



TRAVIS

Part No.	Size	Price
BLS200	2"	
BLS300	3"	
BLS400	4"	
BLS500	5"	
BLS600	6"	
BLS700	7"	
BLS800	8"	

PRESS-ON FEMALE MAINLINE COUPLER



PIERCE

Part No.	Size	Price
P1014-72	3"	
P1014-73	4"	
P1014-75	6"	

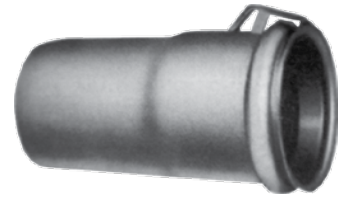

TRAVIS

Part No.	Size	Price
S200	2"	
S300	3"	
S400	4"	
S500	5"	
S600	6"	
S700	7"	
S800	8"	

PRESS-ON MALE MAINLINE COUPLER



PIERCE

Part No.	Size	Price
P1042-01	3"	
P1042-02	4"	
P1042-03	5"	
P1042-04	6"	



TRAVIS

Part No.	Size	Price
PO-ME300	3"	
PO-ME400	4"	
PO-ME500	5"	
PO-ME600	6"	

UNIVERSAL PRESS-ON MAINLINE TEE TO LATERAL VALVE SET



PIERCE

Part No.	Size	Valve	Price
P1055-82	4"	3"	
P1056-81	4"	4"	
P1056-83	6"	4"	



TRAVIS

Part No.	Size	Valve	Price
BLSUVT333	3"	3"	
BLSUVT444	4"	4"	
BLSUVT554	5"	4"	
BLSUVT664	6"	4"	
BLSUVT774	7"	4"	
BLSUVT884	8"	4"	

UNIVERSAL PRESS-ON MAINLINE TEE TO LATERAL VALVE



PIERCE

Part No.	Size	Valve	Price
P1055-62	4"	3"	
P1056-61	4"	4"	
P1056-63	6"	4"	



TRAVIS

Part No.	Size	Valve	Price
BLSUVT443-LBL	4"	3"	
BLSUVT444-LBL	4"	4"	
BLSUVT664-LBL	6"	4"	

UNIVERSAL IN-LINE MAINLINE TEE TO LATERAL VALVE



PIERCE

Part No.	Size	Valve	Price
P1072-62	4"	3"	
P1073-61	4"	4"	
P1073-63	6"	4"	

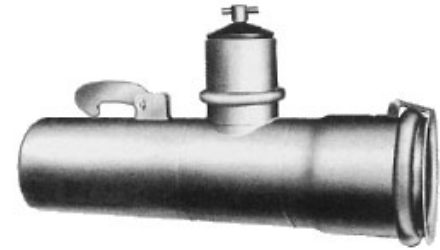

TRAVIS

Part No.	Size	Valve	Price
BLSUVT-L333	3"	3"	
BLSUVT-L444	4"	4"	
BLSUVT-L554	5"	4"	
BLSUVT-L664	6"	4"	
BLSUVT-L774	7"	4"	
BLSUVT-L884	8"	4"	

END TEE



PIERCE

Part No.	Size	Price
P1079-61	2"	
P1077-61	3"	
P1077-62	4"	
P1078-62	6"	

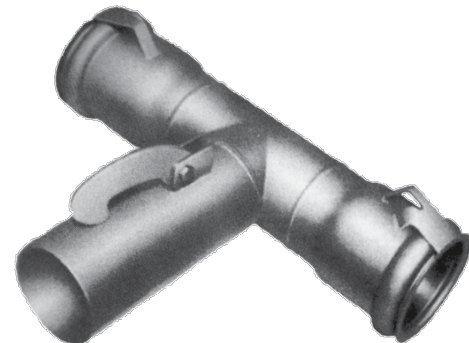

TRAVIS

Part No.	Size	Price
BLSET200	2"	
BLSET300	3"	
BLSET400	4"	
BLSET500	5"	
BLSET600	6"	
BLSET700	7"	
BLSET800	8"	

INTRO
 1. ELECTRICAL
 2. PUMP ACC.
 3. HOSE, PE PIPE & ACC.
 4. IPS, PIP PIPE & ACC.
 5. SURFACE
 6. SPRINKLERS
 7. TRAVELER & WHEEL MOVE
 8. PIVOT
 9. TURN
 10. LOW VOLUME
 11. FILTERS
 12. INJECTION
 13. HARDWARE
 INDEX

FIELD / LINE TEE



PIERCE

Part No.	Size	Price
P1092-61	2"	
P1091-61	3" x 3" x 2"	
P1091-62	3"	
P1090-62	4" x 4" x 3"	
P1090-63	4"	
P1089-64	6"	



TRAVIS

Part No.	Size	Price
BLSFT200	2"	
BLSFT300	3"	
BLSFT400	4"	
BLSFT500	5"	
BLSFT600	6"	
BLSFT700	7"	
BLSFT800	8"	

45° ELBOW



PIERCE

Part No.	Size	Price
P1121-61	2"	
P1122-61	3"	
P1123-61	4"	
P1125-61	6"	



TRAVIS

Part No.	Size	Price
BLSFE-200-45	2"	
BLSFE-300-45	3"	
BLSFE-400-45	4"	
BLSFE-500-45	5"	
BLSFE-600-45	6"	
BLSFE-700-45	7"	
BLSFE-800-45	8"	

90° ELBOW



PIERCE

Part No.	Size	Price
P1103-61	2"	
P1104-61	3"	
P1105-61	4"	
P1107-61	6"	



TRAVIS

Part No.	Size	Price
BLSFE200	2"	
BLSFE300	3"	
BLSFE400	4"	
BLSFE500	5"	
BLSFE600	6"	
BLSFE700	7"	
BLSFE800	8"	

REDUCER



PIERCE

Part No.	Size	Price
P1085-61	3" x 2"	
P1085-63	4" x 3"	
P1085-68	6" x 4"	



TRAVIS

Part No.	Size	Price
BLSR203	3" x 2"	
BLSR304	4" x 3"	
BLSR405	5" x 4"	
BLSR406	6" x 4"	
BLSR506	6" x 5"	
BLSR607	7" x 6"	
BLSR608	8" x 6"	
BLSR708	8" x 7"	

WELD-ON STARTER COUPLER



PIERCE

Part No.	Size	Price
P1048-62	3"	
P1048-63	4"	
P1048-64	5"	
P1048-65	6"	
P1048-67	8"	



TRAVIS

Part No.	Size	Price
SCGHB200	2"	
SCGHB300	3"	
SCGHB400	4"	
SCGHB500	5"	
SCGHB600	6"	
SCGHB700	7"	
SCGHB800	8"	
SCGHB1000	10"	
SCGHB1200	12"	

END PLUG



PIERCE

Part No.	Size	Price
P1087-01	2"	
P1087-02	3"	
P1087-03	4"	
P1087-04	5"	
P1087-05	6"	



TRAVIS

Part No.	Size	Price
BLSEP200	2"	
BLSEP300	3"	
BLSEP400	4"	
BLSEP500	5"	
BLSEP600	6"	
BLSEP700	7"	
BLSEP800	8"	

DISCHARGE ADAPTER



PIERCE

Part No.	Size	Price
P1739-63	2" x 2"	
P1740-63	2" x 3"	
P1739-65	3" x 3"	
P1740-67	3" x 4"	
P1739-66	4" x 4"	



TRAVIS

Part No.	Size	Price
BLSDA202	2" x 2"	
BLSDA203	2" x 3"	
BLSDA303	3" x 3"	
BLSDA304	3" x 4"	
BLSDA404	4" x 4"	
BLSDA405	4" x 5"	
BLSDA406	4" x 6"	
BLSDA407	4" x 7"	
BLSDA505	5" x 5"	
BLSDA506	5" x 6"	
BLSDA507	5" x 7"	
BLSDA508	5" x 8"	
BLSDA606	6" x 6"	
BLSDA607	6" x 7"	
BLSDA608	6" x 8"	

FEMALE COUPLER X HOSE BARB



PIERCE

Part No.	Size	Price
P1788-61	2"	
P1788-62	3"	
P1788-63	4"	
P1788-64	5"	
P1788-65	6"	



TRAVIS

Part No.	Size	Price
BLSHF200	2"	
BLSHF300	3"	
BLSHF400	4"	
BLSHF500	5"	
BLSHF600	6"	
BLSHF800	8"	

MALE END X HOSE BARB



PIERCE

Part No.	Size	Price
P1791-01	2"	
P1791-02	3"	
P1791-04	4"	
P3150-04	4" with floating band	
P1791-06	5"	
P1791-07	6"	



TRAVIS

Part No.	Size	Price
BLSHM200	2"	
BLSHM300	3"	
BLSHM400	4"	
BLSHM500	5"	
BLSHM600	6"	
BLSHM800	8"	

PIERCE GALVANIZED STEEL VALVE OPENING ELBOWS & TEES

RING LOCK VALVE OPENING ELBOW

Part No.	Ring Lock Inlet	Ring Lock Universal Bell Outlet	Price
P1716-62	3"	3"	
P1716-65	4"	4"	
P1716-72	6"	4"	
P1716-74	6"	6"	
P1715-63	8"	6"	
P1715-65	8"	8"	
P3619-61	10"	10"	



BAND & LATCH VALVE OPENING ELBOW

Part No.	Ring Lock Inlet	Band & Latch Universal Bell Outlet	Side Outlet	Price
P1694-61	3"	2"	-	
P1694-62	3"	3"	-	
P1694-64	4"	3"	-	
P1694-65	4"	4"	-	
P1694-68	5"	4"	-	
P1694-69	5"	5"	-	
P1694-72	6"	4"	-	
P1694-73	6"	5"	-	
P1694-74	6"	6"	-	
P1699-63	8"	6"	-	
P1699-65	8"	8"	-	
P0037-47	10"	8"	-	
P0052-57	10"	10"	-	
P1698-64	4"	3"	3/4"	
P1698-65	4"	4"	3/4"	



BAND & LATCH VALVE OPENING TEE

Part No.	Ring Lock Inlet	Band & Latch Universal Bell Outlet	Band & Latch Universal Bell Outlet	Side Outlet	Price
P1711-64	4"	3"	3"	-	
P1711-65	4"	4"	4"	-	
P1711-72	6"	4"	4"	-	
P1711-74	6"	6"	6"	-	
P1713-63	8"	6"	6"	-	
P1712-76	8"	8"	8"	-	
P3113-64	4"	3"	3"	3/4"	
P3113-65	4"	4"	4"	3/4"	



TRAVIS GALVANIZED STEEL VALVE OPENING ELBOWS & TEES

COMBINATION RING LOCK & BAND & LATCH VALVE OPENING ELBOW

Part No.	Ring Lock Inlet	RL / B&L Univ. Bell Outlet	Price
SUVEO302	3"	2"	
SUVEO303	3"	3"	
SUVEO402	4"	2"	
SUVEO403	4"	3"	
SUVEO404	4"	4"	
SUVEO504	5"	4"	
SUVEO505	5"	5"	
SUVEO604	6"	4"	
SUVEO605	6"	5"	
SUVEO606	6"	6"	
SUVEO806	8"	6"	
SUVEO808	8"	8"	



COMBINATION RING LOCK & BAND & LATCH VALVE OPENING TEE

Part No.	Ring Lock Inlet	RL / B&L Univ. Bell Outlet	Price
SUVEO-T322	3"	2" x 2"	
SUVEO-T333	3"	3" x 3"	
SUVEO-T433	4"	3" x 3"	
SUVEO-T444	4"	4" x 4"	
SUVEO-T544	5"	4" x 4"	
SUVEO-T555	5"	5" x 5"	
SUVEO-T644	6"	4" x 4"	
SUVEO-T655	6"	5" x 5"	
SUVEO-T666	6"	6" x 6"	
SUVEO-T866	8"	6" x 6"	
SUVEO-T888	8"	8" x 8"	



GUN STAND OPENER

Part No.	Ring Lock Inlet	FIPT Outlet	Price
SUVEO-GS303	3"	3"	
SUVEO-GS403	4"	3"	



BARTOS GALVANIZED OR EPOXY STEEL VALVE OPENING ELBOWS & TEES

COMBINATION RING LOCK AND BAND & LATCH VALVE OPENING ELBOW AND TEE

Size	VALVE OPENING ELBOW			VALVE OPENING TEE		
	Galvanized Part No.	Epoxy Part No.	Price	Galvanized Part No.	Epoxy Part No.	Price
4" x 3"	EVOS43G	EVOS43		EVOD43G	EVOD43	
4" x 4"	EVOS4G	EVOS4		EVOD4G	EVOD4	
5" x 5"	EVOS5G	EVOS5		EVOD5G	EVOD5	
6" x 3"	EVOS63G	EVOS63		EVOD63G	EVOD63	
6" x 4"	EVOS64G	EVOS64		EVOD64G	EVOD64	
6" x 5"	EVOS65G	EVOS65		EVOD65G	EVOD65	
6" x 6"	EVOS6G	EVOS6		EVOD6G	EVOD6	
8" x 3"	EVOS83G	EVOS83		EVOD83G	EVOD83	
8" x 4"	EVOS84G	EVOS84		EVOD84G	EVOD84	
8" x 5"	EVOS85G	EVOS85		EVOD85G	EVOD85	
8" x 6"	EVOS86G	EVOS86		EVOD86G	EVOD86	
8" x 7"	EVOS87G	EVOS87		EVOD87G	EVOD87	
8" x 8"	EVOS8G	EVOS8		EVOD8G	EVOD8	
10" x 3"	EVOS103G	EVOS103		EVOD103G	EVOD103	
10" x 4"	EVOS104G	EVOS104		EVOD104G	EVOD104	
10" x 5"	EVOS105G	EVOS105		EVOD105G	EVOD105	
10" x 6"	EVOS106G	EVOS106		EVOD106G	EVOD106	
10" x 7"	EVOS107G	EVOS107		EVOD107G	EVOD107	
10" x 8"	EVOS108G	EVOS108		EVOD108G	EVOD108	
10" x 10"	EVOS10G	EVOS10		EVOD10G	EVOD10	



TRAVIS - RAINWAY ALUMINUM VALVE OPENING ELBOWS & TEES

RAINWAY UNIVERSAL VALVE ELBOW OPENER

Part No.	Ring Lock Inlet	Band & Latch Outlet	Price
UVEO302	3"	2"	
UVEO303	3"	3"	
UVEO403	4"	3"	
UVEO404	4"	4"	

RAINWAY UNIVERSAL VALVE TEE OPENER

Part No.	Ring Lock Inlet	Band & Latch Outlet	Price
UVEO-T433	4"	3" x 3"	
UVEO-T444	4"	4" x 4"	



RAINWAY SPECIALTY VALVE OPENERS

Part No.	Hook Type Inlet	Band & Latch Outlet	Price
RVEO302	3"	2"	
RVEO303	3"	3"	
RVEO403	4"	3"	
RVEO404	4"	4"	
RVEO505	5"	5"	
RVEO606	6"	6"	



To be used with V, RVTC, SRVML, RVML.

INTRO
 1. ELECTRICAL
 2. PUMP ACC.
 3. HOSE, PE PIPE & ACC.
 4. IPS, PIP PIPE & ACC.
 5. SURFACE
 6. SPRINKLERS
 7. TRAVELER & WHEEL MOVE
 8. PIVOT
 9. TURF
 10. LOW VOLUME
 11. FILTERS
 12. INJECTION
 13. HARDWARE
 INDEX

TRAVIS - RAINWAY ALUMINUM GUN STAND VALVE OPENER

RAINWAY UNIVERSAL GUN STAND VALVE OPENER

Part No.	Ring Lock Inlet	FIPT Outlet	Price
UVEO-GS303	3"	3"	
UVEO-GS403	4"	3"	



TRAVIS - A&M ALUMINUM VALVE OPENING ELBOWS & TEES

A&M VALVE OPENING ELBOW FOR 4" UNIVERSAL RISER VALVE

Part No.	Ring Lock Inlet	Band & Latch Outlet	Price
*V04333	4"	3"	
V04433	4"	4"	

* Come standard with 3/4" FIPT side outlet.

A&M VALVE OPENING TEE FOR 4" UNIVERSAL RISER VALVE

Part No.	Ring Lock Inlet	Band & Latch Outlet	Price
*V034333	4"	3" x 3"	
V044433	4"	4" x 4"	

* Come standard with 3/4" FIPT side outlet.

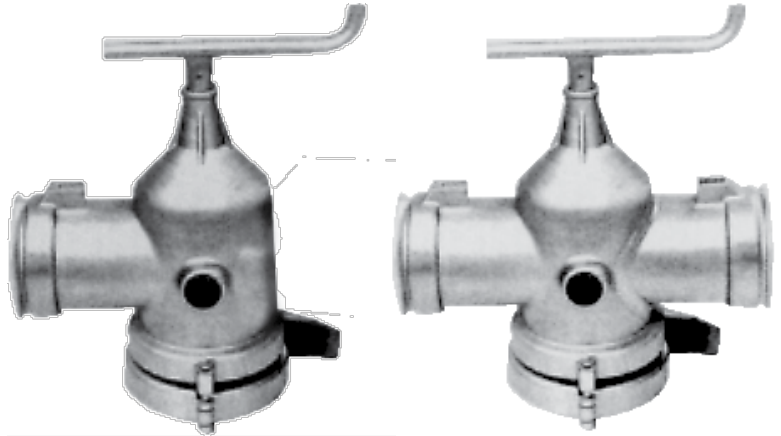

XCAD ALUMINUM VALVE OPENING ELBOWS

XCAD VALVE OPENING ELBOW

Part No.	Ring Lock Inlet	Band & Latch Outlet	Price
VOE4X3	4"	3"	
VOE4X4	4"	4"	

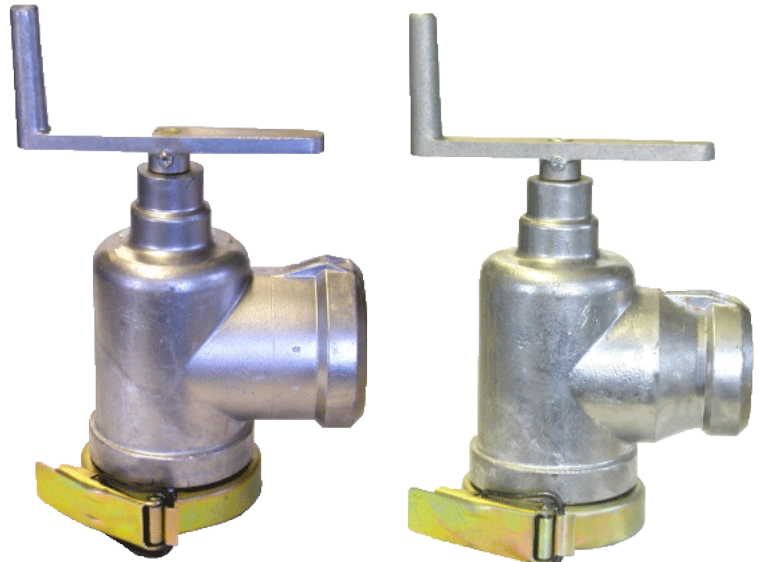

PIERCE GALVANIZED VALVE OPENER PARTS

GALVANIZED VALVE OPENER REPAIR PARTS

#	Part No.	Description	Price
1	P1681-01	Handle with Collar, 3" to 6"	
1	P1174-01	Handle with Collar, 8"	
2	P2107-06	Pin, Roll (Handle) 3" to 6"	
2	P2107-11	Pin, Roll (Handle) 8"	
3*	P1191-01	Stem with Solid Yoke, 3/4" 3" & 4"	
3*	P1191-02	Stem with Solid Yoke, 3/4" 5" & 6"	
3*	P1683-01	Stem with Solid Yoke, 1" for 8"	
4	P2100-01	Gasket, Chevron, Rubber 3" to 6"	
4	P2101-01	Gasket, Chevron, Rubber 8"	
6	P2031-02	1/4" Lock Nut	
7	P1679-01	Clamp Lock Ring 3"	
7	P1679-02	Clamp Lock Ring 4"	
7	P1679-03	Clamp Lock Ring 5"	
7	P1679-04	Clamp Lock Ring 6"	
7	P1679-05	Clamp Lock Ring 8"	
8	P2018-10	Clamp Lock Bolt 1/4" x 3-1/2"	
9	P2308-01	Clamp Lock Ring Bail 3" to 8"	
10	YFV090-02503C	3" - 6" VOE Stem Yoke (Clutch)	
8-10	F090-02508C	VOE Stem Yoke (Clutch)	
**	P3040-03	Stem 3/4" x 7-1/4"	
**	P3040-04	Stem 3/4" x 9-1/4"	
**	P1683-01	Stem 1" x 16" VOE 8" & 10"	

* New Style

** Old Style with holes.

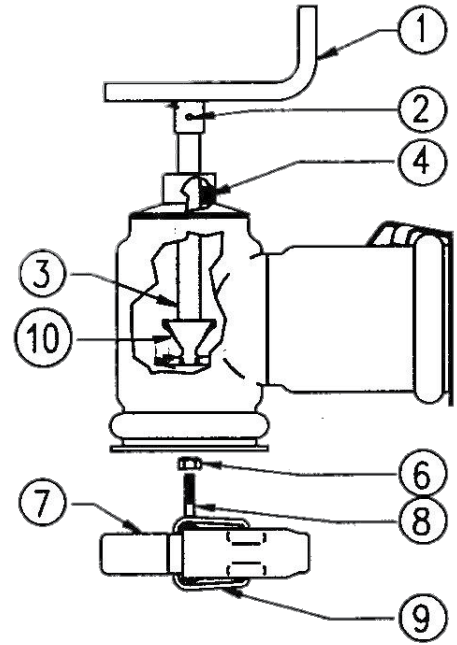

TRAVIS GALVANIZED VALVE OPENER PARTS

GALVANIZED VALVE OPENER REPAIR PARTS

Part No.	Description	Price
SUVEO-STEM-9.25	3/4" x 9-1/4" VOE Stem for 3" & 4" VOE	
SUVEO-STEM-12	3/4" x 12" VOE Stem for 5" & 6" VOE	
SUVEO-SSA-9	1 Pc. 3/4" Shaft 9" Long Socket Assy. for 3" & 4" VOE	
SUVEO-SSA-15	1 Pc. 3/4" Shaft 15" Long Socket Assy. for 8" VOE	
SUVEO-T-CRANK	3/4" Steel Crank Handle for 3" Thru 8" VOE	
SUVEO-YOKE	Stem Shank Yoke, Only for 3" Thru 6" VOE (Fits 3/4" & 5/8" Stems)	
SUVEO-CLAMP-3	3" Clamp Lock Ring for 3" VOE	
SUVEO-CLAMP-4	4" Clamp Lock Ring for 4" VOE	
SUVEO-CLAMP-5	5" Clamp Lock Ring for 5" VOE	
SUVEO-CLAMP-6	6" Clamp Lock Ring for 6" VOE	
SUVEO-CLAMP-8	8" Clamp Lock Ring for 8" VOE	
SUVEO-HANDLEPIN	Handle Roll Pin 1"	
SUVEO-SOCKETPIN	Socket (Yoke) Roll Pin 1-1/4"	
CHEVRON-3/4	3/4" Chevron Gasket for VOE	



RAINWAY - ALUMINUM VALVE OPENER REPAIR PARTS

Part No.	Description	Price
UVEO-STEM-9-1/4	5/8" x 9-1/4" VOE Stem for 3" & 4" VOE	
UVEO-T-CRANK-A	5/8" Aluminum Crank Handle for 3" & 4" VOE	
UVEO-T-CRANK	5/8" Steel Crank Handle for 3" & 4" VOE	
UVEO-YOKE	VOE Stem Shank Yoke (Yoke only)	
UVEO-GLANDNUT	Gland Nut for VOE	
UVEO-PACKING	Packing for VOE	
UVEO-CLAMP-3	3" Clamp Lock Ring VOE	
UVEO-CLAMP-4	4" Clamp Lock Ring VOE	
UVEO-ROLLPIN	Handle Roll Pin	
UVEO-SOCKETPIN	Socket (Yoke) Roll Pin 1-1/4"	



XCAD ALUMINUM VALVE OPENER PARTS

ALUMINUM VALVE OPENER REPAIR PARTS

Part No.	Description	Price
VOEHDL34	3/4" Aluminum Handle	
4RLVOE	4" VOE Clamp	
VOESHFT34	3/4" x 10" Zinc-Plated Shaft	
VOECLT34	3/4" Brass Clutch	
VOESEAL34	Chevron Seal 3/4"	
VOESEAL58	Chevron Seal 5/8"	
VOEHDL58	5/8" Aluminum Handle	
VOESHFT58	5/8" x 10" Zinc-Plated Shaft	
VOECLT58	5/8" Brass Clutch	
VOECLTGR34	3/4" Brass Gheen-style Receiver	
VOECLTGR58	5/8" Brass Gheen-style Receiver	
VOECLTGS34	3/4" Brass Gheen-style Stem	
VOECLTGS58	5/8" Brass Gheen-style Stem	



BARTOS GALVANIZED OR EPOXY VALVE OPENER PARTS

CLAMP LOCK RINGS

Part No.	Valve Size	Price
EVOLR4	4"	
EVOLR6	6"	
EVOLR8	8"	
EVOLR10	10"	



STAINLESS STEEL STEMS

Part No.	Valve Size	Price
EVOST4	4"	
EVOST6	6"	
EVOST8	8"	
EVOST1	10"	



MISCELLANEOUS PARTS

Part No.	Description	Price
EVOH	HANDLE	
EVOPN	PACKING NUT	
EVOTP	TEFLON PACKING	
EVOC	CLUTCH	



RISER ACCESSORIES

POLY RISERS

Model	Description	Price
WPLIR-324	Poly Riser 3 x 24	
WPLIR-330	Poly Riser 3 x 30	
WPLIR-336	Poly Riser 3 x 36	
WPLIR-342	Poly Riser 3 x 42	
WPLIR-348	Poly Riser 3 x 48	
WPLIR-424	Poly Riser 4 x 24	
WPLIR-430	Poly Riser 4 x 30	
WPLIR-436	Poly Riser 4 x 36	
WPLIR-442	Poly Riser 4 x 42	
WPLIR-448	Poly Riser 4 x 48	



RISERENCH

Part No.	Description	Price
3STD PVC	3" PVC	
3STD POLY	3" Poly	
4STD PVC	4" PVC	
4STD POLY	4" Poly	

The Riserench™ is a tool used to repair or replace broken riser pipes and fittings. With this tool most broken risers are able to be replaced within minutes, instead of hours or days.



GALVANIZED STEEL VALVE STUBS

PIERCE GALVANIZED VALVE STUBS

UNIVERSAL VALVE STUB - WELD-ON PLATED STEEL STEM

Part No.	Size	Length	Price
P1724-01	3"	4"	
P1724-02	4"	6"	
P1724-03	5"	6"	
P1724-04	6"	6"	
P1724-05	8"	9"	
P1724-17	10"	10"	



TRAVIS GALVANIZED VALVE STUBS

UNIVERSAL VALVE STUB - WELD-ON PLATED STEEL STEM

Part No.	Size	Length	Price
UVS-S300	3"	4"	
UVS-S400	4"	6"	
UVS-S500	5"	6"	
UVS-S600	6"	6"	
UVS-S800	8"	9"	



UNIVERSAL VALVE STUB - WELD-ON STAINLESS STEEL STEM

Part No.	Size	Length	Price
P1724-01-SS	3"	4"	
P1724-02-SS	4"	6"	
P1724-03-SS	5"	6"	
P1724-04-SS	6"	6"	
P1724-05-SS	8"	9"	
P1724-17-SS	10"	10"	



UNIVERSAL VALVE STUB - WELD-ON STAINLESS STEEL STEM

Part No.	Size	Length	Price
UVS-S300-SS	3"	4"	
UVS-S400-SS	4"	6"	
UVS-S500-SS	5"	6"	
UVS-S600-SS	6"	6"	
UVS-S800-SS	8"	9"	



UNIVERSAL VALVE STUB - LONG BODY PLATED STEEL STEM

Part No.	Size	Length	Price
P1724-16	4"	9"	
P1724-08	4"	12"	
P1724-14	6"	9"	
P1724-12	6"	12"	
P1724-05	8"	9"	
P0013-65	8"	12"	
P1724-17	10"	10"	



UNIVERSAL VALVE STUB - LONG BODY PLATED STEEL STEM

Part No.	Size	Length	Price
UVS-S400-09	4"	9"	
UVS-S400-12	4"	12"	
UVS-S500-09	5"	9"	
UVS-S500-12	5"	12"	
UVS-S600-09	6"	9"	
UVS-S600-12	6"	12"	
UVS-S800	8"	9"	
UVS-S800-12	8"	12"	



UNIVERSAL VALVE STUB - LONG BODY STAINLESS STEEL STEM

Part No.	Size	Length	Price
P1724-16-SS	4"	9"	
P1724-08-SS	4"	12"	
P1724-14-SS	6"	9"	
P1724-12-SS	6"	12"	
P1724-05-SS	8"	9"	
P0013-65-SS	8"	12"	
P1724-17-SS	10"	10"	



UNIVERSAL VALVE STUB - LONG BODY STAINLESS STEEL STEM

Part No.	Size	Length	Price
UVS-S400-09-SS	4"	9"	
UVS-S400-12-SS	4"	12"	
UVS-S500-09-SS	5"	9"	
UVS-S500-12-SS	5"	12"	
UVS-S600-09-SS	6"	9"	
UVS-S600-12-SS	6"	12"	
UVS-S800-SS	8"	9"	
UVS-S800-12-SS	8"	12"	



UNIVERSAL VALVE STUB - 12" BODY W/ AIR VENT ARM PLATED STEEL STEM

Part No.	Size	Arm	Price
P0057-88	4"	2" MIPT	
P0052-46	6"	2" MIPT	
P0057-87	8"	2" MIPT	



UNIVERSAL VALVE STUB - 12" BODY W/ AIR VENT ARM PLATED STEEL STEM

Part No.	Size	Arm	Price
UVS-S412-AVA2	4"	2" MIPT	
UVS-S612-AVA2	6"	2" MIPT	
UVS-S812-AVA2	8"	2" MIPT	
UVS-S812-AVA3	8"	3" MIPT	



INTRO
 1. ELECTRICAL
 2. PUMP ACC.
 3. HOSE, PE PIPE & ACC.
 4. IPS, PIP PIPE & ACC.
 5. SURFACE
 6. SPRINKLERS
 7. TRAVELER & WHEEL MOVE
 8. PIVOT
 9. TURF
 10. LOW VOLUME
 11. FILTERS
 12. INJECTION
 13. HARDWARE
 INDEX

GALVANIZED STEEL VALVE STUBS

PIERCE GALVANIZED VALVE STUBS

UNIVERSAL VALVE STUB - FIPT INLET PLATED STEEL STEM

Part No.	Size	Price
P1726-01	3" x 3"	
P1725-03	3" x 4"	
P1726-02	4" x 4"	
P1726-04	6" x 6"	
P1726-05	8" x 8"	
P0056-48	10" x 10"	

Note: First number indicates thread size.



TRAVIS GALVANIZED VALVE STUBS

UNIVERSAL VALVE STUB - FIPT INLET PLATED STEEL STEM

Part No.	Size	Price
UVS-STF3002	3" x 2"	
UVS-STF3003	3" x 3"	
UVS-STF3004	3" x 4"	
UVS-STF4003	4" x 3"	
UVS-STF4004	4" x 4"	
UVS-STF5005	5" x 5"	
UVS-STF6006	6" x 6"	
UVS-STF8008	8" x 8"	

Note: Second number indicates thread size.



UNIVERSAL VALVE STUB - FIPT INLET STAINLESS STEEL STEM

Part No.	Size	Price
P1726-01-SS	3" x 3"	
P1725-03-SS	3" x 4"	
P1726-02-SS	4" x 4"	
P1726-04-SS	6" x 6"	
P1726-05-SS	8" x 8"	
P0056-48-SS	10" x 10"	

Note: First number indicates thread size.



UNIVERSAL VALVE STUB - FIPT INLET STAINLESS STEEL STEM

Part No.	Size	Price
UVS-STF3002-SS	3" x 2"	
UVS-STF3003-SS	3" x 3"	
UVS-STF4003-SS	4" x 3"	
UVS-STF4004-SS	4" x 4"	
UVS-STF5005-SS	5" x 5"	
UVS-STF6006-SS	6" x 6"	
UVS-STF8008-SS	8" x 8"	

Note: Second number indicates thread size.



UNIVERSAL VALVE STUB - MIPT INLET PLATED STEEL STEM

Part No.	Size	Price
P1729-01	3" x 3"	
P1729-02	4" x 4"	
P1729-04	6" x 6"	
P1729-05	8" x 8"	

UNIVERSAL VALVE STUB - MIPT INLET STAINLESS STEEL STEM

Part No.	Size	Price
P1729-01-SS	3" x 3"	
P1729-02-SS	4" x 4"	
P1729-04-SS	6" x 6"	
P1729-05-SS	8" x 8"	

TRAVIS - RAINWAY GALVANIZED VALVE STUBS

LUG TYPE VALVE STUB - WELD-ON

Part No.	Size	Length	Price
UVS-SL300	3"	6"	
UVS-SL400	4"	6"	
UVS-SL500	5"	6"	
UVS-SL600	6"	6"	



WELD-ON VALVE STUB WITH 3/4" RVTC BRASS STEM

Part No.	Size	Length	Price
SRVML406	4"	6"	
SRVML412	4"	12"	
SRVML506	5"	6"	
SRVML512	5"	12"	
SRVML606	6"	6"	
SRVML612	6"	12"	



GALVANIZED, EPOXY AND ALUMINUM VALVE STUBS

BARTOS GALVANIZED OR EPOXY VALVE STUBS

Size	BEADED STYLE			MIPT STYLE			FIPT STYLE		
	Galvanized Part No.	Epoxy Part No.	Price	Galvanized Part No.	Epoxy Part No.	Price	Galvanized Part No.	Epoxy Part No.	Price
4"	-	-		HPV4MG	HPV4M		HPV4FG	HPV4F	
6"	HPV6G	HPV6		HPV6MG	HPV6M		HPV6FG	HPV6F	
8"	HPV8G	HPV8		HPV8MG	HPV8M		HPV8FG	HPV8F	
10"	HPV10G	HPV10		HPV10MG	HPV10M		HPV10FG	HPV10F	
Air Vent Arms:			2" Add	3" Add			4" Add		



ALUMINUM VALVE STUBS

TRAVIS - RAINWAY ALUMINUM VALVE STUBS

PLAIN UNIVERSAL VALVE STUB WELD-ON

Part No.	Size	Price
UVS300	3"	
UVS400	4"	
UVS500	5"	
UVS600	6"	



SPECIALTY WELD-ON VALVE STUB

Part No.	Size	Price
V300	3"	
V400	4"	
V500	5"	

Use with RVEO Specialty Valve Opener - Page 37



UNIVERSAL VALVE STUB WITH WELD-ON SADDLE

Part No.	Size	Price
UVS404	4" x 4"	
UVS405	4" x 5"	
*UVS406	4" x 6"	
UVS407	4" x 7"	
*UVS408	4" x 8"	
*UVS410	4" x 10"	
*UVS412	4" x 12"	



THREADED UNIVERSAL VALVE STUB

Part No.	Size	Price
UVS-TM3003	3" x 3"	
UVS-TM4004	4" x 4"	
UVS-TF3002	3" x 2"	
UVS-TF3025	3" x 2-1/2"	
UVS-TF3003	3" x 3"	
UVS-TF4003	4" x 3"	
UVS-TF4004	4" x 4"	
UVS-TF5005	5" x 5"	
UVS-TF6006	6" x 6"	

TM = Threaded Male
 TF = Threaded Female
 First digit indicates valve size.
 Second digit indicates thread size.



* Cast with square weld-on apron.
 First digit indicates valve size.
 Second digit indicates saddle size.

XCAD ALUMINUM VALVE STUBS

THREADED ALUMINUM RISER VALVE STUBS

Part No.	Size	Stem	Price
ALVSC43	4" x 3"	Plated	
ALVSC44	4" x 4"	Plated	
ALVSBRS*	Brass Spider		

Available with either plated or brass stems.
 * Wade style with replaceable brass spider.



INTRO
 1. ELECTRICAL
 2. PUMP Acc.
 3. HOSE, PE Pipe & Acc.
 4. IPS, PIP Pipe & Acc.
 5. SURFACE
 6. SPRINKLERS
 7. TRAVELER & WHEEL MOVE
 8. PIVOT
 9. TURN
 10. LOW VOLUME
 11. FILTERS
 12. INJECTION
 13. HARDWARE
 INDEX

TRAVIS VALVE STUB REPAIR PARTS

REPAIR PARTS - UNIVERSAL VALVE STUB STEMS

Part No.	Size	Length	Material	Valve	Price
STEM-6-3/4	5/8"	6-3/4"	Plated	3" or 4"	
STEM-6-3/4-BRS	5/8"	6-3/4"	Brass	3" or 4"	
STEM-6-3/4-SS	5/8"	6-3/4"	Stainless	3" or 4"	
STEM-9	5/8"	9"	Plated	5" or 6"	
STEM-9-BRS	5/8"	9"	Brass	5" or 6"	
STEM-9-SS	5/8"	9"	Stainless	5" or 6"	
STEM-11	1"	11"	Plated	8"	
*RVTC	3/4"	6-5/8"	Brass	4" - 6"	

* For Rainway Valve Stubs.



DOMED DISC FOR UNIVERSAL VALVE STUBS

Part No.	Valve	Hole	Price
DOMED DISC 3	3"	5/8"	
DOMED DISC 4	4"	5/8"	
DOMED DISC 5	5"	5/8"	
DOMED DISC 6	6"	5/8"	
DOMED DISC 8	8"	1"	



FLAT DISC FOR UNIVERSAL VALVE STUBS

Part No.	Valve	Hole	Price
FLAT DISC-3-1/2	3"	1/2"	
FLAT DISC-3-5/8	3"	5/8"	
FLAT DISC-3-3/4	3"	3/4"	
FLAT DISC-4-1/2	4"	1/2"	
FLAT DISC-4-5/8	4"	5/8"	
FLAT DISC-4-3/4	4"	3/4"	
*FLAT DISC-4-SR	4"	5/8"	
FLAT DISC-5-5/8	5"	5/8"	
FLAT DISC-5-3/4	5"	3/4"	
FLAT DISC-6-5/8	6"	5/8"	
FLAT DISC-6-3/4	6"	3/4"	



* For Sure Rane Valve Stub.

WELD IN STEEL SPIDER FOR UNIVERSAL VALVE STUB

PERMANENT		
Part No.	Valve Size	Price
WSS-3	3"	
WSS-4	4"	
WSS-5	5"	

PERMANENT HEAVY DUTY		
Part No.	Valve Size	Price
WSS3HD	3"	
WSS4HD	4"	
WSS5HD	5"	
WSS6HD	6"	
WSS8HD	8"	

REPLACEABLE		
Part No.	Valve Size	Price
WSS4RP	4"	



VALVE STUB REPAIR PARTS

PIERCE VALVE STUB REPAIR PARTS

VALVE STUB STEM - PLATED STEEL

Part No.	Size	Length	Valve	Price
P2086-01	5/8"	6-34"	3" or 4"	
P2086-02	5/8"	9"	5" or 6"	
P2114-01	1"	11-1/4"	8"	
P2114-02	1"	14"	10"	

VALVE STUB STEM - STAINLESS STEEL

Part No.	Size	Length	Valve	Price
P2086-03	5/8"	6-34"	3" or 4"	
P2086-04	5/8"	9"	5" or 6"	
P2114-21	1"	12"	8" or 10"	

VALVE STUB DISC

Part No.	Valve	Hole	Price
P1059-01	3"	5/8"	
P1060-01	4"	5/8"	
P1061-01	5"	5/8"	
P1062-01	6"	5/8"	
P1063-01	8"	1"	
P1063-02	10"	1"	



XCAD VALVE STUB REPAIR PARTS

VALVE STUB STEMS

Part No.	Size	Length	Material	Valve	Price
UNVSPS	5/8"	6-3/4"	Plated Steel	3" or 4"	
UNVSBS	5/8"	6-3/4"	Brass	3" or 4"	
UNVRRBS	5/8"	5"	Brass	Redi-Rain	



VALVE STUB DISC

Part No.	Description	Valve Size	Price
UNVSR	Universal Cap	4"	
UNVSFC	Universal Flat Cap	4"	
UNVSWRC	Wade-Style Cap	4"	

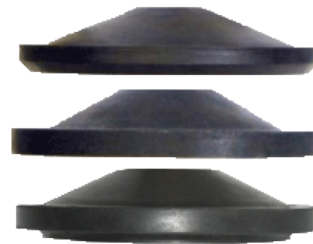

BARTOS VALVE STUB REPAIR PARTS

VALVE STUB DISC

Part No.	Valve	Hole	Price
HPVR4L	4"	3/4"	
HPVR6L	6"	3/4"	
HPVR8L	8"	3/4"	
HPVR1L	10"	3/4"	



STAINLESS SCREW

Part No.	Size	Length	Valve	Price
HPVR4S	3/4"	8"	4"	
HPVR6S	3/4"	10"	6"	
HPVR8S	3/4"	11"	8"	
HPVR1S	7/8"	14"	10"	



INFURSA ALUMINUM ALFALFA VALVES & HYDRANTS



**ALUMINUM ALFALFA VALVE
SPIGOT FOR PVC PIPE**

Part No.	Size	Price
VAIN0006	6"	
VAIN0008	8"	
VAIN0010	10"	
VAIN0012	12"	



**ALUMINUM UNIVERSAL
PORTABLE HYDRANT**

Part No.	Size	Price
COAR0606	6" x 6"	
COAR0808	8" x 8"	
COAR1008	10" x 8"	
COAR1010	10" x 10"	
COAR1208	12" x 8"	
COAR1210	12" x 10"	
COAR1212	12" x 12"	

FRESNO IRON ALFALFA VALVES & ALUMINUM HYDRANTS



**IRON ALFALFA VALVE
SERIES 2800 TYPE RB 28B
REMOVABLE ARCH
SPIGOT FOR PVC PIPE**

Part No.	Size	Price
F028-80003	8"	
F028-10003	10"	
F028-12005	12"	
F028-14005	14" x 15"	
F028-18005	18"	



**ALUMINUM UNIVERSAL
PORTABLE HYDRANT
SERIES 3200 SIDE CLAMP**

Part No.	Size	Price
F032-06014	6" x 6"	
F032-08014	8" x 6"	
F032-08016	8" x 8"	
F032-10016	10" x 8"	
F032-10018	10" x 10"	
F032-10019	10" x 12"	
F032-12014	12" x 6"	
F032-12016	12" x 8"	
F032-12018	12" x 10"	
F032-12019	12" x 12"	
F032-14014	14" x 8"	
F032-14015	14" x 10"	
F032-14016	14" x 12"	
F032-18014	18" x 10"	
F032-18016	18" x 12"	



**IRON ALFALFA VALVE
SERIES 2800 TYPE SA 28C
SOLID ARCH
SPIGOT FOR PVC PIPE**

Part No.	Size	Price
F028-60007	6"	
F028-80007	8"	
F028-10007	10"	
F028-10008	10" x 8"	
F028-12007	12"	
F028-12009	12" x 8"	
F028-12008	12" x 10"	

WATERMAN IRON ALFALFA VALVES & ALUMINUM HYDRANTS



**IRON ALFALFA VALVE
SUNSHINE TYPE 4
REMOVABLE ARCH
SPIGOT FOR PVC PIPE**

Part No.	Size	Price
026-08-040	8"	
026-10-040	10"	
026-12-040	12"	
026-15-154	15" x 14"	
026-18-040	18"	



**ALUMINUM UNIVERSAL
PORTABLE HYDRANT
SINGLE OUTLET - HOOK TYPE**

Part No.	Size	Price
032-10-604	6" x 4"	
032-10-605	6" x 5"	
032-10-606	6" x 6"	
032-10-805	8" x 5"	
032-10-806	8" x 6"	
032-10-808	8" x 8"	
032-11-005	10" x 5"	
032-11-006	10" x 6"	
032-11-008	10" x 8"	
032-11-010	10" x 10"	
032-11-205	12" x 5"	
032-11-206	12" x 6"	
032-11-208	12" x 8"	
032-11-210	12" x 10"	
032-11-212	12" x 12"	
032-11-808	18" x 8"	
032-11-810	18" x 10"	
032-11-812	18" x 12"	



**IRON ALFALFA VALVE
SUNSHINE TYPE 4
SOLID ARCH
SPIGOT FOR PVC PIPE**

Part No.	Size	Price
024-06-014	6"	
024-08-014	8"	
024-10-014	10"	
024-12-014	12"	

INTRO
1. ELECTRICAL
2. PUMP ACC.
3. HOSE, PE PIPE & ACC.
4. IPS, PIP PIPE & ACC.
5. SURFACE
6. SPRINKLERS
7. TRAVELER & WHEEL MOVE
8. PIVOT
9. TURN
10. LOW VOLUME
11. FILTERS
12. INJECTION
13. HARDWARE
INDEX

FRESNO SLIDE GATE

FRESNO SLIDE GATE SERIES 6600 MODEL 101C COMPLETE GATES, 6" - 60"

Flat Back Part No.	Price	Spigot Back Part No.	Price	Gate Size	Weight Lbs.	Minimum Frame Ht.	Add Per Foot
F066-06G024		F066-06H024		6"	56	24"	
F066-08G024		F066-08H024		8"	65	24"	
F066-10G024		F066-10H024		10"	70	24"	
F066-12G024		F066-12H024		12"	79	24"	
F066-14G036		F066-14H036		14"	89	36"	
F066-15G036		F066-15H036		15"	104	36"	
F066-16G036		F066-16H036		16"	113	36"	
F066-18G036		F066-18H036		18"	152	36"	
F066-20G048		F066-20H048		20"	171	48"	
F066-21G048		F066-21H048		21"	179	48"	
F066-24G048		F066-24H048		24"	199	48"	
F066-30G060		F066-30H060		30"	366	60"	
F066-36G072		F066-36H072		36"	576	72"	
F066-42G072		F066-42H072		42"	680	72"	
F066-48G084		F066-48H084		48"	738	84"	
F066-54G096		F066-54H096		54"	1,230	96"	
F066-60G108		F066-60H108		60"	1,805	108"	



Note: Series 6600 slide gates are used where pressure is in seating direction only. Flat back models for headwall or flange mounting. Spigot back models for mounting to corrugated pipe. Applications include canals and ditches, flood control systems, oil refineries, fish hatcheries and various low head industrial water control systems.

FRESNO TOGGLE GATE

FRESNO TOGGLE GATE - GALVANIZED - SERIES 5500

Standard Size Part No.	Price	Gate Diameter Size	Full Size Part No.	Price
F055-0612		6"	F055-0610	
F055-0812		8"	F055-0810	
F055-1012		10"	F055-1010	
F055-1212		12"	F055-1210	
F055-1412		14"	F055-1410	
F055-1512		15"	F055-1510	
F055-1612		16"	F055-1610	
F055-1812		18"	F055-1810	
F055-2012		20"	F055-2010	
F055-2112		21"	F055-2110	
F055-2412		24"	F055-2410	
F055-3012		30"	F055-3010	

Note: Standard size gates have undersized tubes to fit concrete pipe & allow room for mortared installation. Generally 1/2" undersized.

Full size gates have tubes slightly under the nominal size for use where less clearance between the pipe and the gate is desired.

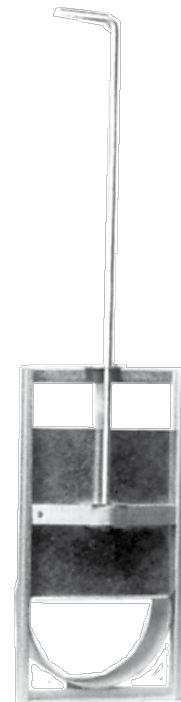

FRESNO DISTRIBUTING GATE

Series 5300 Galvanized Distributing Gates provide cost effective flow control in very low pressure situations.



FRESNO DISTRIBUTING GATE

Tube Length	Gate Diameter							
	2"	Price	2-1/2"	Price	3"	Price	4"	Price
1-5/8"	F053-02015		-		-		-	
1-3/4"	F053-02016		F053-02416		-		-	
2"	F053-02020		F053-02420		F053-03020		F053-04020	
2-1/2"	F053-02024		F053-02424		F053-03024		F053-04024	
3"	F053-02030		F053-02430		F053-03030		F053-04030	
4"	F053-02040		F053-02440		F053-03040		F053-04040	
Slide Only	F053-02000		F053-02400		F053-03000		F053-04000	

Note: Part numbers listed are for standard size gates for mortared installation in concrete pipe.

Gate Diameter	Standard Size Part No.	Price	Full Size Part No.	Price	PIP Size Part No.	Price	Slide Only Part No.	Price
5"	F053-0512		F053-0510		-		F053-0500	
6"	F053-0612		F053-0610		F053-0620		F053-0600	
8"	F053-0812		F053-0810		F053-0820		F053-0800	
10"	F053-1012		F053-1010		F053-1020		F053-1000	
12"	F053-1212		F053-1210		F053-1220		F053-1200	
14"	F053-1412		F053-1410		-		F053-1400	
15"	F053-1512		F053-1510		F053-1520		F053-1500	
16"	F053-1612		F053-1610		-		F053-1600	
18"	F053-1812		F053-1810		-		F053-1800	
20"	F053-2012		F053-2010		-		F053-2000	
21"	F053-2112		F053-2110		-		F053-2100	
24"	F053-2412		F053-2410		-		F053-2400	
30"	F053-3012		F053-3010		-		F053-3000	
36"	F053-3612		F053-3610		-		F053-3600	

Note: Standard size gates have undersized tubes to fit concrete pipe & allow room for mortared installation. Generally 1/2" undersized. Full size gates have tubes slightly under the nominal size for use where less clearance between the pipe & gate is desired. PIP size gates have tubes which fit over the outside diameter of PIP pipe sizes. I.D. 1/4" larger than pipe size.

EXTENSION HANDLE WITH GG HOOK

Part No.	Valve Size	Price
F051-0003	3" - 5"	
F051-0004	6" - 14"	

INTRO
 1. ELECTRICAL
 2. PUMP ACC.
 3. HOSE, PE PIPE & ACC.
 4. PIP, PIP PIPE & ACC.
 5. SURFACE
 6. SPRINKLERS
 7. TRAVELER & WHEEL MOVE
 8. PIVOT
 9. TURF
 10. LOW VOLUME
 11. FILTERS
 12. INJECTION
 13. HARDWARE
 INDEX

THE NAVIGATOR

NAVIGATOR FOR GATED PIPE

Size	Galv #	S.S #	Price
6"	1604G	1604S	
8"	1804G	1804S	
10"	1104G	1104S	
12"	1124G	1124S	

NAVIGATOR W/ OD PIPE BOTH SIDES

Size	Galv #	S.S #	Price
6"	1600G	1600S	
8"	1800G	1800S	
10"	1100G	1100S	
12"	1120G	1120S	
16"	1150G	1150S	
18"	1180G	1180S	



PIP STARTER ON BOTH SIDES

Size	Galv #	S.S #	Price
6"	1603G	1603S	
8"	1803G	1803S	
10"	1103G	1103S	
12"	1123G	1123S	
15"	1153G	1153S	
18"	1183G	1183S	

IPS OR FLANGE STARTER ON BOTH SIDES

Size	Galv #	S.S #	Price
6"	1602G	1602S	
8"	1802G	1802S	
10"	1102G	1102S	
12"	1122G	1122S	
16"	116FG	116FS	
18"	118FG	118FS	

REDUCER VALVE FOR GATED PIPE MXF

Size	Galv #	S.S #	Price
8" TO 6"	0806RG	0806RS	
10" TO 8"	1008RG	1008RS	
10" TO 6"	1006RG	1006RS	
12" TO 10"	1210RG	1210RS	
12" TO 8"	1208RG	1208RS	

REDUCER VALVE PIP STARTER BOTH SIDES

Size	Galv #	S.S #	Price
8" TO 6"	0806PRG	0806PRS	
10" TO 6"	1008PRG	1008PRS	
12" TO 10"	1210PRG	1210PRS	
15" TP 12"	1512PRG	1512PRS	

PLEASE CALL FOR ADDITIONAL SIZES AND ADAPTER OPTIONS
 UP TO 52" EXTENTION AVAILABLE
 ALL VALVES HOLD UP TO 25PSI
 AVAILABLE:
 HOLD STAKES 5/8 x 20
 REPLACEMENT HANDLES
 REPLACEMENT GATES



A&M

DRAIN		
Part No.	Size	Price
G22	2"	
G32	3"	
G42	4"	
G52	5"	
G62	6"	
G82	8"	



NON-DRAIN		
Part No.	Size	Price
G23	2"	
G33	3"	
G43	4"	
G452	4-1/2"	
G53	5"	
G63	6"	
G73	7"	
G83	8"	
G103	10"	



HIGH PRESSURE OR SOLID SET		
Part No.	Size	Price
3G5	3"	
4G5	4"	
5G5	5"	
6G5	6"	
8G5	8"	
10G5	10"	



AKRON TYPE

Part No.	Size	Price
485-20	2"	
485-30	3"	
485-40	4"	
485-50	5"	
485-60	6"	

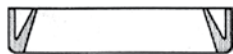

AMES ABC-Q TYPE

Part No.	Size	Price
480-20	2"	
480-30	3"	
480-40	4"	
480-50	5"	
480-60	6"	
480-70	7"	

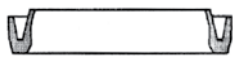

AMES TYPE SPRINGS

STANDARD		
Part No.	Size	Price
580-20	2"	
580-30	3"	
580-40	4"	
580-50	5"	
580-60	6"	



AMES LO-HI TYPE

Part No.	Size	Price
481-60	6"	
481-70	7"	
481-80	8"	
481-100	10"	
481-120	12"	

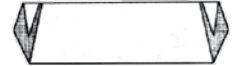

BARTOS FOR IPS BOLTED COUPLERS

Part No.	Size	Price
BCI2	2"	
BCI25	2-1/2"	
BCI3	3"	
BCI4	4"	
BCI5	5"	
BCI6	6"	
BCI8	8"	
BCI10	10"	
BCI12	12"	

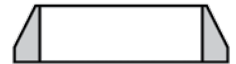

BARTOS FOR OD/PIP BOLTED COUPLERS

Part No.	Size	Price
BCD3	3"	
BCD4	4"	
BCD5	5"	
BCD6	6"	
BCD8	8"	
BCD10	10"	
BCD12	12"	
BCD14	14"	
BCD16	16"	
BCD18	18"	

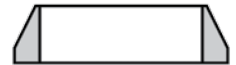

BAUER TYPE METRIC O-RING

Part No.	Size	Price
436-65	65 x 9	
436-82	82 x 13	
436-108	108 x 14	
436-125	125 x 14	
436-133	133 x 14	
436-153	153 x 18	
436-159	159 x 14	
436-174	174 x 18	
436-224	224 x 18	
436-255	255 x 18	

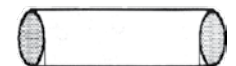

GASKETS

BEN GAR TYPE

Part No.	Size	Price
433-60	6"	
433-70	7"	
433-80	8"	
433-100	10"	

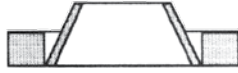

CLOUDBURST TYPE

Part No.	Size	Price
458-40	4"	
458-50	5"	
458-60	6"	



CAM-LOCK TYPE FLAT WASHERS SEALS

Part No.	Size	Price
600-05	1/2"	
600-07	3/4"	
600-10	1"	
600-12	1-1/4"	
600-15	1-1/2"	
600-20	2"	
600-25	2-1/2"	
600-30	3"	
600-40	4"	
600-60	6"	
600-80	8"	

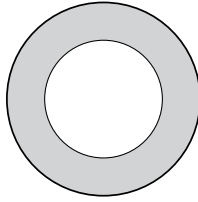

DECOTO TYPE SEAL RING

Part No.	Size	Price
426-40	4"	
426-50	5"	
426-50DL	5"	



* Double Lip Wheel Line Gasket

DIAMOND WATERGATE TYPE

Part No.	Size	Price
AE-6	6"	
AE-7	8"	
AE-10B	10"	
AE-11A	12"	



DRAGON TYPE

Part No.	Size	Price
425-30	3"	
425-40	4"	
425-50	5"	
425-60	6"	

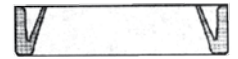

CHAMPION TYPE

Part No.	Size	Price
486-20	2"	
*486-21	2"	
486-30	3"	
486-40	4"	
486-50	5"	
486-60	6"	
486-80	8"	



* For Aluminum Coupler 3/8" Outer Lip

DRESSER TYPE

Part No.	Size	Price
102407 (1)	2" IPS	
102408 (1)	2-1/2" IPS	
102409 (1)	3" IPS	
102410 (1)	4" IPS	
102412 (1&2)	5" IPS	
102414 (1)	6" IPS	
102416 (2)	6" IPS	
102418 (1)	8" IPS	
102420 (2)	8" IPS	
102422	10" IPS	
102424 (2)	12" IPS	
103650 (2)	6" PIP	
103651 (3)	6" PIP	
103652 (2)	8" PIP	
103653 (3)	8" PIP	
103654 (3)	10" PIP	
103656 (2&3)	12" PIP	
103658	15.3" PIP	
103660	18.36" PIP	
103662	20.4" PIP	



CLEARVIEW D&K TYPE

Part No.	Size	Price
102407	2"	
102408	2-1/2"	
102409	3"	
102410	4"	
102412	5"	
102414	6"	
102418	8"	



- 1) D&K CLEARVIEW
- 2) BARTOS
- 3) PVC FITTINGS

FARMLAND SBS-Q TYPE VERY SLOW DRAIN

Part No.	Size	Price
470-20	2"	
470-30	3"	
470-40	4"	
470-50	5"	
470-60	6"	

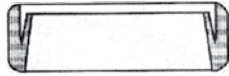

FRESNO FOR BOLTED COUPLINGS

Part No.	Size	Price
F088-3023	2" IPS	
F088-3142	14" OD	
F088-3152	15" OD/PIP	
F088-3162	16" OD/PIP	
F088-3182	18" OD/PIP	
F088-3212	21" PIP	
F088-3242	24" PIP	

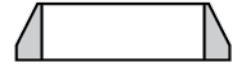

FARMLAND SBS-QRD TYPE "GREEN-DOT" NON-DRAIN

Part No.	Size	Price
472-30	3"	
472-40	4"	
472-50	5"	
472-60	6"	
472-80	8"	

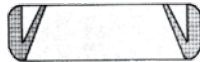

AC TYPE		
Part No.	Size	Price
F090-120-073	6.57"-6.70"	
F090-120-063	6.84"-7.28"	
F090-120-072	8.56"-8.75"	
F090-120-062	8.99"-9.43"	

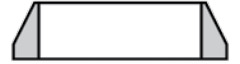

FELCO (FELTON)

DRAIN TYPE		
Part No.	Size	Price
1706-1	2"	
1586-1	3"	
1588-1	4"	

NON-DRAIN TYPE		
Part No.	Size	Price
1587-1	3"	
1589-1	4"	
1232-4	5"	
1232-5	6"	
1574-1	7"	
1860-2	8"	
*1832-1	8"	
1232-9	10"	
417-120	12"	

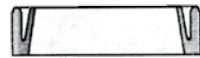

GHEEN TYPE

Part No.	Size	Price
490-20	2"	
490-30	3"	
490-40	4"	
490-50	5"	
490-60	6"	
490-80	8"	
490-100	10"	
490-120	12"	

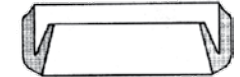

HASTINGS TYPE

Part No.	Size	Price
424-60	6"	
424-80	8"	
424-100	10"	
424-120	12"	

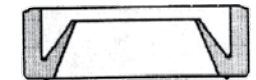

FLANGE GASKET 1/16" FULL FACED RED RUBBER

Part No.	Size	Price
FG1/16-02	2"	
FG1/16-025	2-1/2"	
FG1/16-03	3"	
FG1/16-04	4"	
FG1/16-05	5"	
FG1/16-06	6"	
FG1/16-08	8"	
FG1/16-10	10"	
FG1/16-12	12"	
FG1/16-14	14"	
FG1/16-16	16"	



IRECO - STEELUME

Part No.	Size	Price
*442-15	1-1/2"	
442-20	2"	
442-30	3"	
442-40	4"	
442-50	5"	
442-52	5-1/4"	
442-60	6"	
442-80	8"	
442-100	10"	

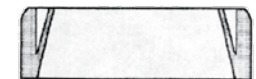

Note: 1/8" Flange Gaskets also available see section 2.
Also see Ring Type Drop in Flange Gasket

* For Trail Line

INTRO | 1. ELECTRICAL | 2. PUMP Acc. | 3. HOSE, PE Pipe & Acc. | 4. IPS, PIP Pipe & Acc. | 5. SURFACE | 6. SPRINKLERS | 7. TRAVELER & WHEEL MOVE | 8. PIVOT | 9. TURF | 10. LOW VOLUME | 11. FILTERS | 12. INJECTION | 13. HARDWARE | INDEX

GASKETS

KROY TYPE NON-DRAIN

Part No.	Size	Price
468-60	6"	
468-80	8"	
468-100	10"	
468-120	12"	

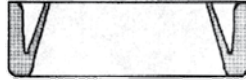

MOORE-RANE TYPE

NON-DRAIN		
Part No.	Size	Price
488-20	2"	
488-30	3"	
488-40	4"	
488-50	5"	
488-60	6"	
488-70	7"	
488-80	8"	
488-100	10"	
488-120	12"	

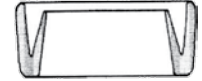

LAKE TYPE - SEE RAIN FOR RENT

LITTLE GIANT PIP

Part No.	Size	Price
205	4"	
166	6"	
167	8"	
168	10"	
170	12"	
373	14"	
335	15"	
345	16"	

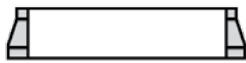

MOULTON TYPE

Part No.	Size	Price
452-20	2"	
452-30	3"	
452-40	4"	
452-50	5"	
452-60	6"	
452-70	7"	
452-80	8"	
452-100	10"	



LITTLE GIANT IPS

Part No.	Size	Price
46	4"	
206	5"	
57	6"	
165	8"	
169	10"	
164	12"	
373	14"	
345	16"	

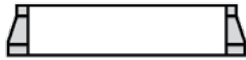

OAKS TYPE

Part No.	Size	Price
450-40	4"	
450-50	5"	
450-60	6"	

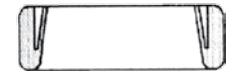

MC DOWELL "SAG" TYPE

Part No.	Size	Price
446-20	2"	
446-30	3"	
446-40	4"	
446-50	5"	
446-60	6"	
446-70	7"	
446-80	8"	
446-100	10"	

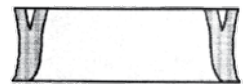

OLIVER TYPE

Part No.	Size	Price
461-20	2"	
461-30	3"	
461-40	4"	
461-50	5"	
461-60	6"	
461-70	7"	

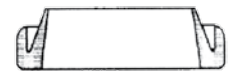

For 1" use Rainmaker 409-15

MC DOWELL SPRINGS

Part No.	Size	Price
546-10	1"	
546-20	2"	
546-30	3"	
546-40	4"	
546-50	5"	
546-60	6"	
546-70	7"	
546-80	8"	



PACIFIC SPEEDLOCK TYPE

NEW STYLE		
Part No.	Size	Price
464-20	2"	
464-30	3"	
464-40	4"	

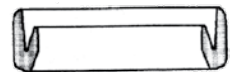

OLD STYLE		
Part No.	Size	Price
462-20	2"	
462-30	3"	
462-40	4"	
462-50	5"	
462-60	6"	
462-80	8"	

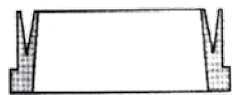

PIERCE IPS COMPRESSION

Part No.	Size	Price
P1600-01	2"	
P1601-01	2-1/2"	
P1602-01	3"	
P1603-01	4"	
P1604-01	5"	
P1605-01	6"	
P1606-01	8"	
P1607-01	10"	
P1608-01	12"	

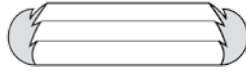

PIERCE IPS WEDGE-TITE®

Part No.	Size	Price
P1640-01	3"	
P1640-02	4"	
P1640-03	5"	
P1640-04	6"	
P1640-05	8"	
P1640-06	10"	
P1640-07	12"	

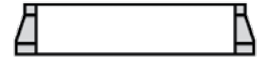

PIERCE PIP COMPRESSION

Part No.	Size	Price
P1609-01	4"	
P1610-01	6"	
P1611-01	8"	
P1612-01	10"	
P1613-01	12"	
P1614-01	15"	
P1615-01	18"	

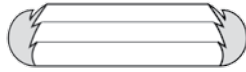

PIERCE OD WEDGE-TITE®

Part No.	Size	Price
P1638-02	4"	
P1638-03	5"	
P1638-04	6"	
P1638-05	8"	
P1638-06	10"	
P1638-07	12"	

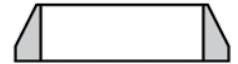

PIERCE PIP WEDGE-TITE®

Part No.	Size	Price
P1639-01	4"	
P1639-02	6"	
P1639-03	8"	
P1639-04	10"	
P1639-05	12"	
P1639-06	15"	



PIERCE FLATBACK

Part No.	Size	Price
P1630-01	2"	
P1631-01	3"	
P1632-01	4"	
P1633-01	5"	
P1634-01	6"	
P1635-01	8"	
P1636-01	10"	



PORT-ALUM TYPE

Part No.	Size	Price
465-20	2"	
465-30	3"	
465-40	4"	
465-50	5"	
465-60	6"	

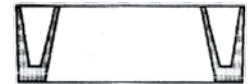

PIERCE ROUND BACK

Part No.	Size	Price
P1616-01	2"	
P1617-01	3"	
P1618-01	4"	
P1619-01	5"	
P1620-01	6"	
P3111-01	6-5/8"	
P1622-01	8"	
P2365-01	8-5/8"	
P1624-01	10"	
P1625-01	12"	

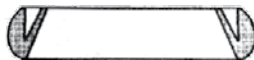

POWER SEAL 3501 TRANSITION TYPE

Part No.	Size	Price
V3504OD2	4" OD	
V3504AA2	4" AA	
V35004A2	4" A	
V35004B2	4" B	
V35004C2	4" C	
V3506OD2	6" OD	
V3506AA2	6" AA	
V35006A2	6" A	
V35006B2	6" B	
V35006C2	6" C	
V3508OD2	8" OD	
V3508AA2	8" AA	
V35008A2	8" A	
V35008B2	8" B	
V35008C2	8" C	
V35010A2	10" A	
V35010B2	10" B	
V35010C2	10" C	



PIERCE TRIPLE LIP

Part No.	Size	Price
P3219-02	8"	
P3219-04	10"	

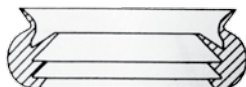

INTRO | 1. ELECTRICAL | 2. PUMP Acc. | 3. HOSE, PE PIPE & Acc. | 4. IPS, PIP Pipe & Acc. | 5. SURFACE | 6. SPRINKLERS | 7. TRAVELER & WHEEL MOVE | 8. PIVOT | 9. TURF | 10. LOW VOLUME | 11. FILTERS | 12. INJECTION | 13. HARDWARE | INDEX

PVC FITTINGS TYPE FOR BOLTED COUPLINGS

FOR PIP		
Part No.	Size	Price
PIPGBC007	6"	
PIPGBC057	8"	
PIPGBC107	10"	
PIPGBC157	12"	
PIPGBC257	15"	

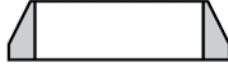

FOR IPS		
Part No.	Size	Price
IPSGBC007	6"	
IPSGBC057	8"	
IPSGBC107	10"	
IPSGBC157	12"	

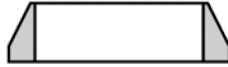

PVC FITTINGS TYPE FOR GASKETED REPAIR COUPLINGS

FOR PIP		
Part No.	Size	Price
PIPGRC003	6"	
PIPGRC053	8"	
PIPGRC103	10"	
PIPGRC153	12"	
PIPGRC253	15"	



FOR IPS		
Part No.	Size	Price
IPSGRC003	6"	
IPSGRC053	8"	
IPSGRC103	10"	
IPSGRC153	12"	

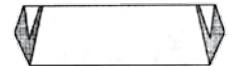

PVC FITTINGS TYPE FOR SURFACE FITTINGS

Part No.	Size	Price
SURGAS001	6"	
SURGAS051	8"	
SURGAS101	10"	
SURGAS151	12"	

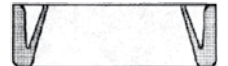

RACE & RACE "DEMOUNTABLE" TYPE 1/2" OUTER LIP

Part No.	Size	Price
414-20	2"	
414-30	3"	
414-40	4"	
414-50	5"	
414-60	6"	
414-80	8"	

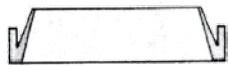

RACE & RACE "LINKLOK" TYPE 1" OUTER LIP

Part No.	Size	Price
415-20	2"	
415-30	3"	
415-40	4"	
415-50	5"	
415-60	6"	
415-70	7"	
415-80	8"	

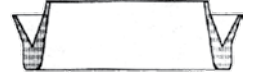

RAIN CONTROL TYPE

Part No.	Size	Price
440-20	2"	
440-30	3"	
440-40	4"	
440-50	5"	
440-60	6"	
440-80	8"	

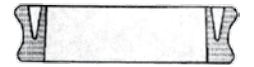

RAIN FOR RENT TYPE

Part No.	Size	Price
457-20	2"	
457-30	3"	
457-40	4"	
457-50	5"	
457-60	6"	
457-70	7"	
457-80	8"	
457-100	10"	
457-120	12"	

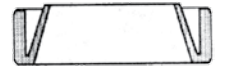

RAINBOW TYPE

Part No.	Size	Price
418-40	4"	
418-50	5"	
418-60	6"	
418-80	8"	

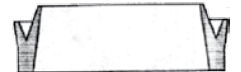

RAINMAKER TYPE

NON-DRAIN		
Part No.	Size	Price
409-15	1-1/2"	
409-20	2"	
409-30	3"	
409-40	4"	
409-50	5"	
409-60	6"	
409-80	8"	

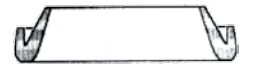

RAINWAY SQUARE BACK

DRAIN		
Part No.	Size	Price
E-22	2"	
E-23	3"	
E-24	4"	

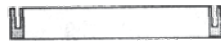

NON-DRAIN		
Part No.	Size	Price
412-20	2"	
E-13	3"	
E-14	4"	
E-15	5"	
E-16	6"	
E-17	7"	
E-18	8"	
E-110	10"	
E-112	12"	



ROUND BACK 3 LIP NON-DRAIN

Part No.	Size	Price
407-30	3"	
407-40	4"	
407-60	6"	
407-80	8"	
407-100	10"	
407-120	12"	



SURE-FLO TYPE SUCTION FILTER SEAL RING

Part No.	Size	Price
473-30	3"	
473-40	4"	
473-50	5"	
473-60	6"	

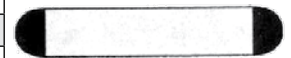

RAVIT TYPE

Part No.	Size	Price
419-20	2"	
419-30	3"	
419-40	4"	
419-50	5"	
419-60	6"	

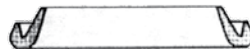

SHUR-RANE TYPE

NEW STYLE - VERY SLOW DRAIN		
Part No.	Size	Price
460-20	2"	
460-30	3"	
460-40	4"	
460-50	5"	
460-60	6"	
460-80	8"	
460-100	10"	
460-120	12"	

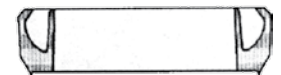

REDI-RAIN TYPE NON-DRAIN

Part No.	Size	Price
*423-12	1-1/4"	
423-20	2"	
423-30	3"	
423-40	4"	
423-50	5"	
423-60	6"	
423-80	8"	
423-100	10"	

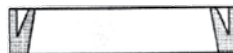

NON-DRAIN - FMC TYPE		
Part No.	Size	Price
454-30	3"	
454-40	4"	
454-50	5"	
454-60	6"	
454-80	8"	

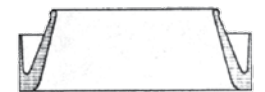

OLD STYLE		
Part No.	Size	Price
455-20	2"	
455-30	3"	
455-40	4"	
455-50	5"	
455-60	6"	
455-70	7"	

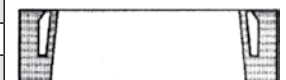

* For Trail Line

RING TYPE DROP IN FLANGE GASKET

Part No.	Size	Price
CPF-3-GR	3"	
CPF-4-GR	4"	
CPF-5-GR	5"	
CPF-6-GR	6"	
CPF-8-GR	8"	
CPF-10-GR	10"	
CPF-12-GR	12"	



STEELUME TYPE - OLD STYLE REFER TO IRECO FOR NEW STYLE

Part No.	Size	Price
441-30	3"	
441-40	4"	
441-50	5"	
441-60	6"	



INTRO 1. ELECTRICAL 2. PUMP Acc. 3. HOSE, PE PIPE & Acc. 4. IPS, PIP PIPE & Acc. 5. SURFACE 6. SPRINKLERS 7. TRAVELER & WHEEL MOVE 8. PIVOT 9. TURF 10. LOW VOLUME 11. FILTERS 12. INJECTION 13. HARDWARE INDEX

GASKETS

STOUT TYPE MOST COMMON STYLE

Part No.	Size	Price
444-20	2"	
444-30	3"	
444-40	4"	
444-50	5"	
444-60	6"	



TRAVIS BOLT TITE

IPS		
Part No.	Size	Price
IPSBTG4	4"	
IPSBTG5	5"	
IPSBTG6	6"	
IPSBTG8	8"	
IPSBTG10	10"	
IPSBTG12	12"	



STOUT TYPE VERY OLD STYLE

Part No.	Size	Price
447-20	2"	
447-30	3"	
447-40	4"	
447-50	5"	
447-60	6"	

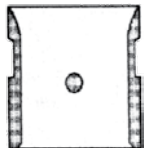

PIP / OD		
Part No.	Size	Price
PIPBTG6	6"	
PIPBTG8	8"	
PIPBTG10	10"	
PIPBTG12	12"	
PIPBTG15	15"	
PIPBTG18.7	18.7"	
PIPBTG20.4	20.4"	

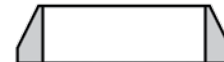

STOUT TYPE SEAL RING

Part No.	Size	Price
445-20	2"	
445-30	3"	
445-40	4"	
445-50	5"	
445-60	6"	

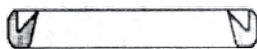

TRAVIS ROUND BACK

Part No.	Size	Price
E-32	2"	
E-33	3"	
E-34	4"	
E-35	5"	
E-36	6"	
E-37	7"	
E-38	8"	
E-310	10"	
E-312	12"	

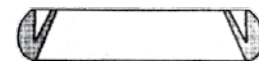

STOUT TOWLINE SEAL RING

Part No.	Size	Price
478-40	3.5"	
478-50	4.5"	



TRAVIS SQUARE BACK TYPE

DRAIN		
Part No.	Size	Price
G39	3"	
G49	4"	

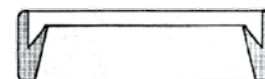

NON-DRAIN		
Part No.	Size	Price
G28	2"	
G38	3"	
G48	4"	
G58	5"	
G68	6"	
G78	7"	
G88	8"	
G108	10"	
G128	12"	



STROLYTE TYPE

Part No.	Size	Price
435-20	2"	
435-30	3"	
435-40	4"	
435-50	5"	
435-60	6"	



THUNDERBIRD TYPE WHEEL LINE

Part No.	Size	Price
426-40TB	4"	



TRI-MATIC TYPE

Part No.	Size	Price
405-15	1.5"	
405-70	7"	



VICTAULIC / GROOVED TYPE

Part No.	Size	Price
105925	2"	
105928	2-1/2"	
106000	3"	
106025	4"	
106026	5"	
106050	6"	
106075	8"	
106077	10"	
106079	12"	

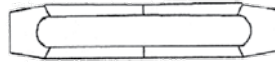

WEBSTER TRIGGER LOCK TYPE

Part No.	Size	Price
453-30	3"	
453-40	4"	
453-50	5"	
453-60	6"	
453-70	7"	
453-80	8"	

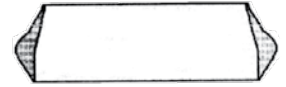

WADE TYPE NORMAL SLOW DRAIN

Part No.	Size	Price
428-20	2"	
428-30	3"	
428-40	4"	
428-50	5"	
428-60	6"	
428-70	7"	
428-80	8"	
428-100	10"	

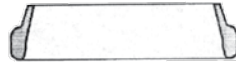

WESTERN SQUARE BACK TYPE

DRAIN		
Part No.	Size	Price
G39	3"	
G49	4"	

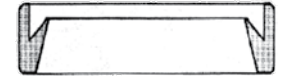

NON-DRAIN		
Part No.	Size	Price
G28	2"	
G38	3"	
G48	4"	
G58	5"	
G68	6"	
G78	7"	
G88	8"	
G108	10"	
G128	12"	



WADE POWERROLL TYPE FAST DRAIN

Part No.	Size	Price
430-40	4"	
430-45	4.5"	
430-50	5"	

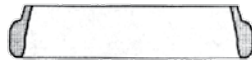

WYSS TYPE

Part No.	Size	Price
475-20	2"	
475-30	3"	
475-40	4"	
475-50	5"	
475-60	6"	



WEBSTER ECONOMIZER TYPE

Part No.	Size	Price
416-20	2"	
416-30	3"	
416-40	4"	
416-50	5"	
416-60	6"	
416-70	7"	
416-80	8"	

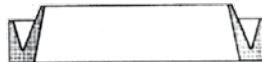

WYSS SEAL RING

Part No.	Size	Price
476-20	2"	
476-30	3"	
476-40	4"	
476-50	5"	
476-60	6"	

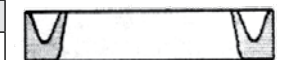

O-RINGS & QUAD RINGS

Part No.	Type	Size ID x WT	Recommended for use with these brands	Price
400-20	"O" Ring	2" x 3/8"	Felton, Port-Alum, Rain Control & Shur-Rane	
400-21	"O" Ring	2" x 1/4"	2" Port-Alum	
400-30	"O" Ring	3" x 3/8"	Felton, Port-Alum, Rain Control & Shur-Rane	
400-31	"O" Ring	3" x 3/8"	Rainmaker L-4	
400-37A	"O" Ring	3-7/8" x 3/16"	Moore-Rane Torque Coupler	
400-40	"O" Ring	4" x 3/8"	Felton, Port-Alum, Rain Control & Shur-Rane	
400-41	"O" Ring	4" x 7/16"	Rainmaker A-4	
200463	"O" Ring	4-3/8" x 5/16"	A&M Round	
400-43	"O" Ring	4-1/2" x 3/16"	Travis-Western & Pierce	
ORG	"O" Ring	4-1/2" x 3/16"	Travis-Western & Pierce	
400-44	"O" Ring	4-1/2" x 1/4"	Lake	
200470	Square Ring	4-1/2" x 1/4"	A&M Square Type	
400-50	"O" Ring	5" x 3/8"	Felton, Port-Alum, Rain Control & Shur-Rane	
400-51	"O" Ring	5" x 3/8"	Rainmaker	
400-54A	"O" Ring	5-3/8" x 1/4"	Shur-Roll	
400-60	"O" Ring	6" x 3/8"	Felton, Port-Alum, Rain Control & Shur-Rane	
404-45	Quad Ring	4-1/2" x 1/4"	Lake	
200426	Quad Ring	4-1/2" x 1/4"	Trunnell	

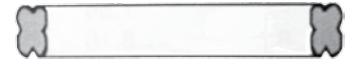
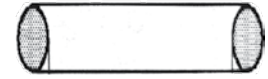

GASKET CROSS REFERENCE

A & M OLD STYLE ROUND BACK	=	PIERCE TYPE
ALUMAX TYPE	=	A & M TYPE
ALUME TYPE	=	STOUT TYPE
AMES QCL TYPE	=	PIERCE TYPE
ATLAS TYPE	=	PIERCE TYPE
AULT TYPE	=	RAINMAKER TYPE (EXCEPT 3")
BEN GAR FULL TYPE	=	A & M TYPE
BOSS TYPE	=	A & M TYPE
BROWN TYPE	=	A & M TYPE
CHAMPION TYPE 3"	=	MOORE RANE/GHEEN TYPE
CROWN AM TYPE	=	RAIN FOR RENT TYPE
DAZOC TYPE	=	MOORE-RANE TYPE, COZAD TYPE, GHEEN TYPE
DECOTO TYPE	=	PIERCE TYPE
DUAL-LOCK TYPE	=	RAINWAY TYPE
FELCO TYPE	=	FELTON TYPE, KROY TYPE
FLEX-O-SEAL TYPE	=	CHICAGO TYPE
FREMONT GATE	=	NUSLIDE GATE
GHEEN TYPE	=	LINDSAY TYPE, COZAD TYPE, MIDWEST BAND & HOOK TYPE
HINESMAN TYPE	=	A & M TYPE
HOMARK TYPE	=	PIERCE TYPE
IRECO ALLUME TYPE	=	STOUT TYPE
KROY TYPE	=	FELTON TYPE
LAKE TYPE	=	WOSCO TYPE, IRECO TYPE, RAIN FOR RENT TYPE
LAKE TORQUE TYPE	=	QUAD RING TYPE
MATTHESON TYPE	=	CHAMPION TYPE
MILLER POSTON TYPE	=	A & M TYPE
MIDWEST TYPE	=	WOSCO TYPE , RAIN FOR RENT TYPE
MOORE RAIN TYPE	=	GHEEN TYPE
PIERCE ROUND BACK TYPE	=	TRAVIS ROUND BACK TYPE
PIERCE FLAT BACK TYPE	=	WESTERN SQUARE BACK TYPE
PORT-ALUME TYPE	=	SHUR RANE TYPE, CHAMPION TYPE
RAIN FOR RENT TYPE	=	IRECO TYPE, WOSCO TYPE, LAKE TYPE, CROWN AM TYPE
RAIN CONTROL TYPE	=	HARDIE TYPE
RAINWAY ROUND TYPE	=	PIERCE TYPE
RAINWAY SQUARE TYPE	=	A & M TYPE
READY RAINE RAIN	=	RAINWAY TYPE
REDI-RAIN TYPE	=	A & M TYPE
ROUND BACK TYPE	=	PIERCE TYPE, TRAVIS TYPE
ROLL-RAIN TYPE	=	SHUR-RANE OLD STYLE TYPE
SHUR-RANE (OLD STYLE) TYPE	=	ROLL-RANE, VERMEER
STOUT TYPE	=	ALLUME TYPE, T-L & IRECO SPEED ROLL TYPE
TELEDYNE TYPE	=	A & M TYPE
TEX FLO-ROUND BACK TYPE	=	PIERCE TYPE (EXCEPT 2 & 3)
TEX FLO-SQUARE BACK	=	HASTINGS
TRAVIS ROUND BACK TYPE	=	PIERCE ROUND BACK TYPE
TRAVIS SQUARE BACK TYPE	=	PIERCE FLAT BACK TYPE, WESTERN SQUARE BACK TYPE
VERMEER TYPE	=	SHUR RANE OLD STYLE TYPE
WOSCO TYPE	=	RAIN FOR RENT TYPE, MIDWEST TYPE, LAKE TYPE
WYSS TYPE	=	CROWN TYPE, MONTGOMERY WARD TYPE, STOUTBILT ALUM. TYPE
WYSS SEAL RING TYPE	=	OLD STYLE STOUT TYPE

INTRO
1. ELECTRICAL
2. PUMP ACC.
3. HOSE, PE PIPE & ACC.
4. IPS, PIP PIPE & ACC.
5. SURFACE
6. SPRINKLERS
7. TRAVELER & WHEEL MOVE
8. PIVOT
9. TURF
10. LOW VOLUME
11. FILTERS
12. INJECTION
13. HARDWARE
INDEX

SECTION 6

Sprinkler Irrigation

CONTENTS

6:3	PIVOT IRRIGATION NOTES
6:4-5	PRESSURE REGULATORS & DRAIN CHECKS
6:4	NELSON MINI PRESSURE REGULATORS & DRAIN CHECKS
6:5	SENNINGER® PRESSURE REGULATORS & DRAIN CHECKS
6:5	NETAFIG PRESSURE REGULATORS
6:6-8	NURSERY SPRINKLERS
6:7	SENNINGER WOBBLERS
6:8	NELSON D10 SPRAY, S10 SPINNER & R10TG ROTATORS®
6:9-13	AG SPRINKLERS
6:9	NELSON R10 & R10T ROTATORS®
6:10	NELSON R2000 ROTATOR®
6:11	NELSON R2000WF WINDFIGHTER & R2000LP ROTATOR®
6:12	NELSON R2000CW COW WASH ROTATOR®
6:12	NELSON R33 / R33LP ROTATOR®
6:13	NELSON ROTATOR® ACCESSORIES
6:14	AG - NELSON FEEDTUBE ASSEMBLIES
6:15-17	AG SPRINKLERS
6:15	RAIN BIRD® FULL CIRCLE SPRINKLERS
6:16	FULL CIRCLE IMPACT SPRINKLERS
6:17	PART OR FULL CIRCLE IMPACT SPRINKLERS
6:18-19	AG - NOZZLES & ACCESSORIES
6:18	NELSON NOZZLES, VANES & ACCESSORIES
6:18	RAIN BIRD® NOZZLES & ACCESSORIES
6:19	JAIN NOZZLES
6:19	XCAD AQUA BURST® NOZZLES & ACCESSORIES
6:20	AG - NOZZLES, RISERS & ACCESSORIES
6:20	SPRINKLER RISERS
6:20	ACCESSORIES
6:21-22	AG SPRINKLERS
6:21	SENNINGER® FULL CIRCLE PLASTIC IMPACT SPRINKLERS
6:22	SENNINGER® PART CIRCLE PLASTIC IMPACT SPRINKLERS
6:22	SENNINGER® 23° F-LUENT® IMPACTS
6:23	NELSON BIG GUN® SPRINKLERS
6:24-25	NELSON BIG GUN® NOZZLES & ACCESSORIES
6:26-32	SIME SPRINKLER GUNS
6:26	TURBINE DRIVE SPRINKLER GUNS
6:27	TURBINE DRIVE SPRINKLER GUNS
6:28	TURBINE DRIVE SPRINKLER GUNS
6:28	IMPACT SPRINKLER GUNS
6:29	IMPACT SPRINKLER GUNS
6:30	IMPACT SPRINKLER GUNS
6:31	IMPACT SPRINKLER GUNS
6:32	IMPACT SPRINKLER GUNS
6:33	GUN ADAPTERS
6:34	GUN STANDS & CARTS
6:34-37	GUN CARTS



NELSON PRESSURE REGULATORS & DRAIN CHECKS



Mini Regulator Drain Check (MRDC)

Ensure high uniformity and even flow throughout your system and eliminate the effects of pressure gains and losses due to uneven topography or high friction loss. The drain check feature eliminates sprinkler drizzle during shut down and start up. Choose from 20, 30, 35, 40, 45, 50 or 60 PSI (1.4, 2.1, 2.4, 2.8, 3.1, 3.4 or 4.1 BAR) nominal pressures.



Mini Regulator (MR)

For systems in which pressure ranges are excessive, the Nelson Mini Regulator provides uniform flow and distribution at each sprinkler through pressure regulation. Ensure high uniformity and even flow throughout your system and eliminate the effects of pressure gains and losses due to uneven topography or high friction loss. Choose from 20, 30, 35, 40, 45, 50 or 60 PSI (1.4, 2.1, 2.4, 2.8, 3.1, 3.4 or 4.1 BAR) nominal pressures.



Mini Drain Check (MDC)

The MDC is a check valve only that opens 2-5 PSI (.14-.35 BAR) below the nominal pressure rating. Available in 20 and 35 PSI (1.4-2.4 BAR) options. Ideal when a check feature only is needed or when it is necessary to operate sprinklers at different pressures that best suit environmental conditions. Perfect for overhead cooling of apples and other crops. The MDC prevents draining of the system between frequent on / off cooling cycles.

NELSON MINI REGULATOR DRAIN CHECK

Part No.	Price
Mini Regulator Drain Check Brown	
Mini Regulator Gray	
Mini Drain Check Green	

Eliminate sprinkler drainage during shut down and start up with the Nelson Mini Regulator Drain Check. It is available in the same pressure options as the Mini Regulator.

For Mini Regulator Drain Check (MRDC) and Mini Regulator (MR) specify pressure: 20, 30, 35, 40, 45, 50 or 60 PSI nominal pressures and specify connection. The MDC is a check valve that only opens 2-5PSI below the nominal pressure rating. Available 20 and 35 PSI.

1/2" FNPT INLET X 1/2" MNPT OUTLET

Model	Part No.
MRDC	11150-0XX
MR	11146-0XX
MDC	11154-020 or 035



1/2" MNPT INLET X 1/2" MNPT OUTLET

Model	Part No.
MRDC	11152-0XX
MR	11148-0XX
MDC	11156-020 or 035



ACME INLET X ACME OUTLET

Model	Part No.
MRDC	10407-0XX
MR	10099-0XX
MDC	11139-020 or 035



1/2" FNPT INLET X ACME OUTLET

Model	Part No.
MRDC	10406-0XX
MR	10020-0XX
MDC	11140-020 or 035



1/2" MNPT INLET X ACME OUTLET

Model	Part No.
MRDC	11153-0XX
MR	11149-0XX
MDC	11157-020 or 035



NELSON PRESSURE REGULATORS

Part No.	Description	Flow Range (GPM)	Price
9491-XXX	Blue Top/Gray Lo-Flo 3/4" FIPT	.5 - 10	
9561-XXX	Blue Top/Gray Lo-Flo FHT x MHT	.5 - 10	
9071-XXX	Blue Top/Black Hi-Flo 3/4" FIPT	2 - 16/20	

XXX = 010 (10 PSI), 015 (15 PSI), 020 (20 PSI), 025 (25 PSI), 030 (30 PSI), 040 (40 PSI), 050 (50 PSI)



SENNINGER® PRESSURE REGULATORS & DRAIN CHECKS



SENNINGER® PRESSURE REGULATORS

Part No.	Description	Flow Range (GPM)	Price
PRL-##	3/4" FIPT Low Flow	1/2 - 5 & 1/10 - 8	
PMR-##MF	3/4" FIPT Medium Flow	4 - 16 & 2 - 20	
PR-##HF	1-1/4" FIPT x 1" FIPT High Flow	10 - 32	
PRXF-##	3" Socket x Socket	20 - 80/85/90/95/100	

- 6, 10, 12, 15, 20, 25, 30, 35, 40, 50, 60 PSI

SENNINGER® DRAIN-STOP PLUS™

Part No.	Description	Price
DSP2M2F	Drain Stop Plus 1/2" MNPT x 1/2" FNPT Outlet	
DSP3B2F	Drain Stop Plus 3/4" Barb x 1/2" FNPT Outlet	



NETAFIM™ PRESSURE REGULATORS



NETAFIM™ PRESSURE REGULATORS

Part No.	Description	Flow Range (GPM)	Price
32PRV.75-LF##V2	3/4" FIPT x 3/4" FIPT	0.25 - 4.4	
32PRV.75-##V2K	3/4" FIPT x 3/4" MIPT	5.50 - 17.6	
32PRV1.5-##V2K	1-1/2" MIPT x 1-1/2" MIPT	11.00 - 35.0	
32PRV2-4##V2K	2" FIPT x 2" FIPT	22.00 - 70.0	
32PRV2-6##V2K	2" FIPT x 2" FIPT	33.00 - 105.6	
32PRV3-10##V2K	3" FIPT x 3" FIPT	55.00 - 175.0	

- 9, 12, 15, 20, 25, 30, 35, 42, 43, 50, 57, 65 PSI

INTRO
1. ELECTRICAL
2. PUMP ACC.
3. HOSE, PE PIPE & ACC.
4. IPS, PIP PIPE & ACC.
5. SURFACE
6. SPRINKLERS
7. TRAVELER & WHEEL MOVE
8. PIVOT
9. TURF
10. LOW VOLUME
11. FILTERS
12. INJECTION
13. HARDWARE
INDEX

NURSERY SPRINKLERS

TBS TWO ARM SPINNERS

Part No.	Description	Price
K8-05F	1/2" Brass Spinners 2 GPM 2/Acorn Tips	
KPL-05F	1/2" Plastic Spinners 1 GPM (Side/Throw)	



ROBERTS SPRINKLER 2 ARM SPINNER

Part No.	Description	Bag Qty	Price
SPK-435F2-50	Sprinkler, 435, 1/2 FPT W/ #2.055 Orifice	50	
SPK-435F3-50	Sprinkler, 435, 1/2 FPT W/ #3.059 Orifice	50	
SPK-435F5-50	Sprinkler, 435, 1/2 FPT W/ #5.078 Orifice	50	
SPK-435F7-50	Sprinkler, 435, 1/2 FPT W/ #7.093 Orifice	50	
SPK-436M2-50	Sprinkler, 436, 1/2 MPT W/ #2.055 Orifice	50	
SPK-436M3-50	Sprinkler, 436, 1/2 MPT W/ #3.059 Orifice	50	
SPK-436M5-50	Sprinkler, 436, 1/2 MPT W/ #5.078 Orifice	50	
SPK-436M7-50	Sprinkler, 436, 1/2 MPT W/ #7.093 Orifice	50	



TBS ADAPTER CAPS FOR BRASS FOGGERS

Part No.	Tap Size	Inlet	Price
PA2010-01	10-32 NPT	1/2" FIPT	
PA2010-02	1/8" FIPT	1/2" FIPT	
PA2010-03	5/16-24 NPT	1/2" FIPT	



SIGNATURE WHIZ HEAD®

Part No.	Description	Price
1973	1/2" FIPT Full Circle Rotary Sprinkler	



SENNINGER® TRIAD

Part No.	Description	Price
TRIAD (US) COMPLETE	3/4" Slip	
TRIAD (MM) COMPLETE	25mm Slip	



SENNINGER® T-SPRAY™

Part No.	Description	Price
T-SPRAY SA	Standard Angle 1/2" MIPT Base, Nozzle Size #6 - 8	
T-SPRAY HA	High Angle 1/2" MIPT Base, Nozzle Size #8	

SENNINGER® SMOOTH DRIVE™

Part No.	Description	Price
SD2214M-2M	1/2" MIPT, Complete with Nozzle Size #6 - 8	



SENNINGER SUPER SPRAY®

Part No.	Description	Price
SUPERSPRAY	Complete Assembly with Nozzle & Plate	

SENNINGER WOBBLERS

SENNINGER XCEL-WOBBLER® FOR UPRIGHT INSTALLATION

Part No.	Description	Price
XCEL HA-3/4" M	Xcel-Wobbler 3/4" MIPT, High Angle, Black Deflector	
XCEL HA-1/2" M	Xcel-Wobbler 1/2" MIPT, High Angle, Black Deflector	
XCEL MA-3/4" M	Xcel-Wobbler 3/4" MIPT, Mid-Angle, White Deflector	
XCEL MA-1/2" M	Xcel-Wobbler 1/2" MIPT, Mid-Angle, White Deflector	

• Mid Angle Apx 18° • High Angle Apx 24° • Nozzle Sizes Available # 6-14



SENNINGER WOBBLER® STANDARD ANGLE

Part No.	Description	Price
WOB-B06B2	Wobbler 1/2" MIPT #6 Nozzle Gold 3/32"	
WOB-B07B2	Wobbler 1/2" MIPT #7 Nozzle Lime 7/64"	
WOB-B08B2	Wobbler 1/2" MIPT #8 Nozzle Lavender 1/8"	
WOB-B09B2	Wobbler 1/2" MIPT #9 Nozzle Gray 9/64"	
WOB-B10B2	Wobbler 1/2" MIPT #10 Nozzle Turquoise 5/32"	
WOB-B11B2	Wobbler 1/2" MIPT #11 Nozzle Yellow 11/64"	
WOB-B12B2	Wobbler 1/2" MIPT #12 Nozzle Red 3/16"	
WOB-B13B2	Wobbler 1/2" MIPT #13 Nozzle White 13/64"	
WOB-B14B2	Wobbler 1/2" MIPT #14 Nozzle Blue 7/32"	



Note: 3/4" Connection available upon request at same price as 1/2" models.

SENNINGER WOBBLER® LOW ANGLE

Part No.	Description	Price
WOB-B06B2LA	Wobbler 1/2" MIPT #6 Nozzle Gold 3/32"	
WOB-B07B2LA	Wobbler 1/2" MIPT #7 Nozzle Lime 7/64"	
WOB-B08B2LA	Wobbler 1/2" MIPT #8 Nozzle Lavender 1/8"	
WOB-B09B2LA	Wobbler 1/2" MIPT #9 Nozzle Gray 9/64"	
WOB-B10B2LA	Wobbler 1/2" MIPT #10 Nozzle Turquoise 5/32"	
WOB-B11B2LA	Wobbler 1/2" MIPT #11 Nozzle Yellow 11/64"	
WOB-B12B2LA	Wobbler 1/2" MIPT #12 Nozzle Red 3/16"	
WOB-B13B2LA	Wobbler 1/2" MIPT #13 Nozzle White 13/64"	
WOB-B14B2LA	Wobbler 1/2" MIPT #14 Nozzle Blue 7/32"	



Note: 3/4" Connection available upon request at same price as 1/2" models.

SENNINGER I-MINI-WOBBLER® (BLUE DEFLECTOR) FOR INVERTED INSTALLATION

Part No.	Description	Price
WOB05M2-INV	1/2" MIPT, Inverted-Mini-Wobbler #5 Beige 5/64"	
WOB06M2-INV	1/2" MIPT, Inverted-Mini-Wobbler #6 Gold 3/32"	
WOB07M2-INV	1/2" MIPT, Inverted-Mini-Wobbler #7 Lime 7/64"	
WOB08M2-INV	1/2" MIPT, Inverted-Mini-Wobbler #8 Lavender 1/8"	



SENNINGER MINI-WOBBLER® (WHITE DEFLECTOR) FOR UPRIGHT INSTALLATION

Part No.	Description	Price
WOB04M2	1/2" MIPT, Mini-Wobbler #4 Light Blue 1/16"	
WOB05M2	1/2" MIPT, Mini-Wobbler #5 Beige 5/64"	
WOB06M2	1/2" MIPT, Mini-Wobbler #6 Gold 3/32"	
WOB07M2	1/2" MIPT, Mini-Wobbler #7 Lime 7/64"	
WOB08M2	1/2" MIPT, Mini-Wobbler #8 Lavender 1/8"	



1. ELECTRICAL
2. PUMP, ACC.
3. HOSE, PE PIPE & ACC.
4. IPS, PIP PIPE & ACC.
5. SURFACE
6. SPRINKLERS
7. TRAVELER & WHEEL MOVE
8. PIVOT
9. TURF
10. LOW VOLUME
11. FILTERS
12. INJECTION
13. HARDWARE
INDEX

NELSON D10 SPRAY, S10 SPINNER & R10TG ROTATORS®

NELSON D10 SPRAYS, S10 SPINNERS & R10TG ROTATORS® (ADD NOZZLES OR ADAPTER TO COMPLETE PRICE)

Part No.	Description	Price
10135-001*	D10 Spray (Acme) w/Flat Spray Plate	
10135-002	D10 Spray 1/2" w/Flat Spray Plate	
10078-1000*	S10 Spinner (Acme) w/Green (Low) Plate	
10078-1001	S10 Spinner 1/2" w/Green (Low) Plate	
10078-2000*	S10 Spinner (Acme) w/Black (High) Plate	
10078-2001	S10 Spinner 1/2" w/Black (High) Plate	
10078-3000*	S10 Spinner (Acme) w/Gray (Flat) Plate	
10078-3001	S10 Spinner 1/2" w/Gray (Flat) Plate	
9914-8004*	R10TG Rotator (Acme) w/Green (Low) Plate	
9914-8001	R10TG Rotator 1/2" w/Green (Low) Plate	
9914-8005*	R10TG Rotator (Acme) w/Black (High) Plate	
9914-8002	R10TG Rotator 1/2" w/Black (High) Plate	
9914-8003*	R10TG Rotator (Acme) w/Gray (Flat) Plate	
9914-8000	R10TG Rotator 1/2" w/Gray (Flat) Plate	



* Acme bases require adapter or feedtube assembly.

NELSON INLET ADAPTERS FOR ACME BODIED SPRINKLERS

Part No.	Size	Description	Price
9465	3/8"	Male Acme x 3/8" MIPT	
9316-002	1/2"	Male Acme x 1/2" MIPT	
9466	3/4"	Male Acme x 3/4" MIPT	
10060-001	1/2"	Male Acme x PVC	
10060-002	3/4"	Male Acme x PVC	



NELSON 2TN NOZZLES FOR SPINNERS, ROTATORS® & SPRAYS

Part No.	Size	Description	Price
9306-078	5/64"	#10 Dark Blue	
9306-086	11/128"	#11 Orange	
9306-094	3/32"	#12 Purple	
9306-102	13/128"	#13 Yellow	
9306-109	7/64"	#14 Green	
9306-117	15/128"	#15 Tan	
9306-125	1/8"	#16 Dark Red	
9306-133	17/128"	#17 Turquoise	
9306-141	9/64"	#18 Gold	
9306-156	5/32"	#20 Brown	



NELSON SPRINKLER ASSEMBLY

Part No.	Description	Price
NCSA	Complete Sprinkler Assembly - D10, S10, R10TG	

Note: Sprinkler is supplied unassembled unless assembly is ordered.

NELSON R10 & R10T ROTATORS®

9913-XXXX

	Thread	Plate	Nozzle
9913-	X	X	XX
	3/8" = 0	Red = 1	
	1/2" = 1	White = 2	
	Acme = 2	Orange = 7	



9914-XXXX

	Thread	Plate	Nozzle
9914-	X	X	XX
	3/8" = 0	Blue = 3	
	1/2" = 1	Purple = 4	
	Acme = 2	Brown = 5	
		Gold = 6	

R10 BODY, PLATE & NOZZLE - COMPLETE

Plate Option	2TN Nozzle Option	Noz. Size	Price
P2 9° Red	9306-040 - #40 Lt. Blue	.040"	
	9306-045 - #45 Lt. Purple	.045"	
	9306-050 - #50 Dk. Green	.050"	
P4 9° White	9306-050 - #50 Dk. Green	.050"	
	9306-055 - #55 Lt. Yellow	7/128"	
	9306-060 - #60 Lt. Red	.060"	
P4 15° Orange	9306-050 - #50 Dk. Green	.050"	
	9306-055 - #55 Lt. Yellow	7/128"	
	9306-060 - #60 Lt. Red	.060"	

R10T BODY, PLATE & NOZZLE - COMPLETE

Plate Option	2TN Nozzle Option	Noz. Size	Price
P6 9° Blue P6 15° Purple	9306-065 - #65 Gray	.065"	
	9306-070 - #70 White	9/128"	
	9306-078 - #78 Dk. Blue	5/64"	
P8 15° Gold P8 24° Brown	9306-086 - #86 Orange	11/128"	
	9306-094 - #94 Purple	3/32"	
	9306-102 - #102 Yellow	13/128"	

R10 & R10T BODY

Part No.	Size	Description	Price
9205-000	3/8"	R10 Body Less Noz. & Plate	
9722-000	3/8"	R10T Body Less Noz. & Plate	
9205-001	1/2"	R10 Body Less Noz. & Plate	
9722-001	1/2"	R10T Body Less Noz. & Plate	
9205-002	Acme	R10 Body Less Noz. & Plate	
9722-002	Acme	R10T Body Less Noz. & Plate	

ROTOR PLATES

Part No.	Description	Price
9460	P2 9° Red (R10)	
9208	P4 9° White (R10)	
9350	P6 9° Blue (R10, R10T)	
9723	P6 15° Purple (R10T)	
10601	P8 24° Brown (R10T)	
10684	P8 15° Gold (R10T)	

2TN NOZZLES FOR R10 & R10T

Part No.	Noz. Size	Color	Price
9306-040	.040"	#5.1 Light Blue	
9306-045	.045"	#5.8 Light Purple	
9306-050	.050"	#6.4 Dark Green	
9306-055	7/128"	#7 Light Yellow	
9306-060	.060"	#7.7 Light Red	
9306-065	.065"	#8.3 Gray	
9306-070	9/128"	#9 White	
9306-078	5/64"	#10 Dark Blue	

R10 & R10T INLET ADAPTERS

Part No.	Size	Description	Price
9465	3/8"	Male Acme x 3/8" MNPT	
9316	1/2"	Male Acme x 1/2" MNPT	
9466	3/4"	Male Acme x 3/4" MNPT	
10060-001	1/2"	Male Acme x 1/2" PVC Slip	
10060-002	3/4"	Male Acme x 3/4" PVC Slip	
10060-003	25mm	Male Acme x 25mm PVC Slip	

Note: Add Inlet Adapters to Body, Nozzle & Plate for Total Unit List Price

FEED TUBE ACCESSORIES

Part No.	Description	Price
9195	Connector (CPSB)	
9284	*5mm Feedtube 1,000' (305 M) Coil	
9099	*10mm Feedtube 500' (152.4 M) Coil	
9813	Coupler 10mm	
9349	Punch Tool, 5mm Red (FT1 & FT2)	
9810	Punch Tool, 7mm Blue (FT4)	
9776	Punch Tool, 10mm White (FT5)	
9835-003	Drill Punch Tool, 5mm (FT1 & FT2)	
9835-002	Drill Punch Tool, 7mm (FT4)	
9835-001	Drill Punch Tool, 10mm (FT5)	
9845	Drill Installation Tool, (Installs #9739 Of FT5)	
9986	Dual Goof Plug for FT1 & FT2 (Must Order in 20's)	
9826	Plug, Rubber (Fits Inside of #9739 QC Barb)	
9831	Plug, Goof (Fits in Place of #9739 QC Barb)	
10287	Stake Installation Tool for the 6.3mm Stake	
10288	Stake Installation Tool for the 8mm Stake	
10301	Goof Plug for FT4	

*NOTE: Tube Assembly Lengths Other Than 30" (for FT1, FT2), 36" (for FT4) & 48" (for FT5) are Available for Orders Totaling 50,000 Feet or More



NELSON R2000 ROTATOR®

COMPLETE R2000 ASSEMBLY SPECIFY PLATE, NOZZLE & ADAPTER SIZE

Part No.	Description	Price
R2000-2TN-TA	Complete R2000 w/ 2TN Nozzle & Threaded Adapter	
R2000-2TN-PA	Complete R2000 w/ 2TN Nozzle & PVC Adapter	
R2000-2FCN-TA	Complete R2000 w/ 2000FC Nozzle & Threaded Adapter	
R2000-2FCN-PA	Complete R2000 w/ 2000FC Nozzle & PVC Adapter	

R2000



R2000 CAP ASSEMBLY & ROTOR PLATE ONLY

Part No.	Description	Price
10519-1209	Cap Assembly w/ K2 9° Green Plate	
10519-1215	Cap Assembly w/ K2 15° Yellow Plate	
10519-1309	Cap Assembly w/ K3 9° Brown Plate	
10519-1315	Cap Assembly w/ K3 15° Red Plate	
10519-1324	Cap Assembly w/ K3 24° Gray Plate	
10519-1406	Cap Assembly w/ K4 6° Turquoise Plate	
10519-1409	Cap Assembly w/ K4 9° Purple Plate	
10519-1412	Cap Assembly w/ K4 12° Wine Plate	
10519-1415	Cap Assembly w/ K4 15° Gold Plate	
10519-1424	Cap Assembly w/ K4 24° Black Plate	
10519-1509	Cap Assembly w/ K5 9° Orange Plate	
10519-1515	Cap Assembly w/ K5 15° Tan Plate	
10519-1524	Cap Assembly w/ K5 24° Blue Plate	



R2000 CAP ASSEMBLY ONLY (LESS PLATE)

Part No.	Description	Price
9422	Cap Assembly w/ Black Diffuser (for K3 & K4)	
9422-002	Cap Assembly w/ White Diffuser (for K2)	
9422-006	Cap Assembly w/ Diffuser (for K5)	



R2000 2T BODY OR 2000FC NOZZLE BODY

Part No.	FCN Flow	Description	Price
9155		2T Body Only	
9223-085	0.85 GPM	R2000 FCN Body (for K2 Plate)	
9223-100	1.00 GPM	R2000 FCN Body (for K2 Plate)	
9223-125	1.25 GPM	R2000 FCN Body (for K3 Plate)	
9223-150	1.50 GPM	R2000 FCN Body (for K3 & K4 Plate)	
9223-200	2.00 GPM	R2000 FCN Body (for K4 Plate)	
9223-250	2.50 GPM	R2000 FCN Body (for K5 Plate)	



R2000 2TN NOZZLES ONLY

Part No.	Size	Description	Price
9306-065	1/16"	#8.3 Gray Noz. (for K2 Plate)	
9306-070	9/128"	#9 White Noz. (for K2 Plate)	
9306-078	5/64"	#10 Dark Blue Noz. (for K2 Plate)	
9306-086	11/128"	#11 Orange Noz. (for K3 Plate)	
9306-094	3/32"	#12 Purple Noz. (for K3 Plate)	
9306-102	13/128"	#13 Yellow Noz. (for K4 Plate)	
9306-109	7/64"	#14 Green Noz. (for K4 Plate)	
9306-117	15/128"	#15 Tan Noz. (for K5 Plate)	
9306-125	1/8"	#16 Dark Red Noz. (for K5 Plate)	



R2000 INLET ADAPTERS ONLY

Part No.	Size	Description	Price
9465	3/8"	Male Acme x 3/8" MNPT	
9316	1/2"	Male Acme x 1/2" MNPT	
9466	3/4"	Male Acme x 3/4" MNPT	
10060-001	1/2"	Male Acme x 1/2" PVC Slip	
10060-002	3/4"	Male Acme x 3/4" PVC Slip	
10060-003	25mm	Male Acme x 25mm PVC Slip	



NELSON R2000WF WINDFIGHTER & R2000LP ROTATOR®

COMPLETE R2000WF ASSEMBLY SPECIFY PLATE, NOZZLE & ADAPTER SIZE

Part No.	Description	Price
R2000WF-TA	Complete with Cap, Plate, Body, Nozzle & Threaded Adapter	
R2000WF-PA	Complete with Cap, Plate, Body, Nozzle & PVC Adapter	



R2000WF

R2000LP

COMPLETE R2000LP ASSEMBLY SPECIFY PLATE, NOZZLE & ADAPTER SIZE

Part No.	Description	Price
R2000LP-TA	Complete with Cap, Plate, Body, Nozzle & Threaded Adapter	
R2000LP-PA	Complete with Cap, Plate, Body, Nozzle & PVC Adapter	

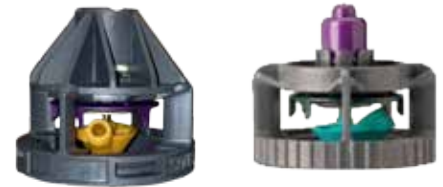

R2000WF CAP ASSEMBLY WITH PLATE ONLY

Part No.	R2000WF Plate	Price
10299-110	10 Purple Plate	
10299-112	12 Purple Plate	
10299-114	14 Green Plate	
10299-116	16 Red Plate	
10299-118	18 Gold Plate	
10299-120	20 Brown Plate	

FULLY ASSEMBLED R2000WF OR R2000 LP- NO ADAPTER

Plate/Nozzle	Model	Assembly #	Price
WF12 Purple	R2000WF	9928-1210	
#10 DK Blue	R2000LP	9929-1210	
WF12 Purple	R2000WF	9928-1211	
#11 Orange	R2000LP	9929-1211	
WF12 Purple	R2000WF	9928-1212	
#12 Purple	R2000LP	9929-1212	
WF14 Green	R2000WF	9928-1413	
#13 Yellow	R2000LP	9929-1413	
WF14 Green	R2000WF	9928-1414	
#14 Green	R2000LP	9929-1414	
WF16 Red	R2000WF	9928-1615	
#15 Tan	R2000LP	9929-1615	
WF16 Red	R2000WF	9928-1616	
#16 Red	R2000LP	9929-1616	
WF18 Gold	R2000WF	9928-1818	
#18 Gold	R2000LP	9929-1818	
WF20 Brown	R2000WF	9928-2020	
#20 Brown	R2000LP	9929-2020	



R2000LP CAP ASSEMBLY WITH PLATE ONLY

Part No.	Model & Plate Part #	Price
10299-210	10 Purple Plate	
10299-212	WF12 Purple - 10452	
10299-214	WF14 Green - 9877	
10299-216	WF16 Red - 9931	
10299-218	WF18 Gold 9870	
10299-220	WF20 Brown - 9878	

R2000WF BODY ONLY

Part No.	Description	Price
9920	WF Body (Female Acme Thread)	



R2000WF NOZZLES ONLY

Part No.	Size	Description	Price
9306-078	5/64"	#10 Dark Blue (use with Purple Plate)	
9306-086	11/128"	#11 Orange (use with Purple Plate)	
9306-094	3/32"	#12 Purple (use with Purple Plate)	
9306-102	13/128"	#13 Yellow (use with Green Plate)	
9306-109	7/64"	#14 Green (use with Green Plate)	
9306-117	15/128"	#15 Tan (use with Red Plate)	
9306-125	1/8"	#16 Red (use with Red Plate)	
9306-141	9/64"	#18 Gold (use with Gold Plate)	
9306-156	5/32"	#20 Brown (use with Brown Plate)	

R2000WF INLET ADAPTERS ONLY

Part No.	Size	Description	Price
9465	3/8"	Male Acme x 3/8" MNPT	
9316	1/2"	Male Acme x 1/2" MNPT	
9466	3/4"	Male Acme x 3/4" MNPT	
10060-001	1/2"	Male Acme x 1/2" PVC Slip	
10060-002	3/4"	Male Acme x 3/4" PVC Slip	
10060-003	25mm	Male Acme x 25mm PVC Slip	



NELSON R2000CW COW WASH ROTATOR®

COMPLETE R2000CW ASSEMBLY

Part No.	Description	Price
R2000CW-TA	Complete with Cap, Plate, Body, Nozzle & 1/2" MIPT Adapter	
NCSA	Complete Sprinkler Assembly - R2000CW	

Note: Sprinkler is supplied unassembled unless assembly is ordered.

R2000CW COW WASH COMPONENTS

Part No.	Description	Price
9422-005	Cap Assembly	
9516-412	K4 12" Plate	
9155	2T Body	
9306-109	7/64" #14 Green 2TN Nozzle	
9306-125	1/8" #16 Red 2TN Nozzle	
9306-141	9/64" #18 Gold 2TN Nozzle	
9316	1/2" MNPT x Male Acme Adapter	
9466	3/4" MNPT x Male Acme Adapter	



NELSON R33 / R33LP ROTATOR®

COMPLETE R33 / R33LP ASSEMBLY

Part No.	Description	Price
11466-10XX	R33 COMPLETE CAP/BODY/NOZ/ADAP	
11466-11XX	R33LP COMPLETE CAP/BODY/NOZ/ADAP	

Note: Sprinkler is supplied unassembled unless assembly is ordered.

R33 / R33LP COMPONENTS

Part No.	Description	Price
11344	R33 ADAPTER	
11161-001	R33/R33LP FLUSH TOOL - SHORT	
11161-002	R33/R33LP FLUSH TOOL - LONG	
11363	R33-R33LP ROAD GUARD	
11473	33TN NOZZLE REMOVAL TOOL	
11478	DIFFUSER/MOTOR INSTALL/REMOVE TOOL	
11417	R33/R33LP KEEPER	
11344-001	R33 ADAPTER WITH KEEPER INSTALLER	



R33 / R33LP Performance (U.S Units)			R33LP Performance Range 25-50 PSI									
			R33 Performance Range 40-65 PSI									
Plate	Part Number		Pressure in PSI									
			25	30	35	40	45	50	55	60	65	
Gold 18 9/64"	R33: 11466-1018	GPM	2.88	3.15	3.40	3.64	3.86	4.07	4.27	4.46	4.65	
	R33LP: 11466-1118	RAD (ft.)	37	38	40	42 43	42 44	42 44	44	44	44	
Brown 20 5/32"	R33: 114466-1020	GPM	3.52	3.85	4.16	4.45	4.72	5.00	5.22	5.45	5.68	
	R33LP: 114466-1120	RAD (ft.)	38	40	42	43 45	43 45	44 45	46	47	46	
Gray 22 11/64"	R33: 11466-1022	GPM	4.24	4.64	5.02	5.37	5.70	6.01	6.30	6.57	6.83	
	R33LP: 11466-1122	RAD (ft.)	39	41	44	44 46	44 47	44 47	47	48	48	
Green 24 3/16"	R33: 11466-1024	GPM	5.00	5.50	5.96	6.38	6.78	7.16	7.52	7.85	8.18	
	R33LP: 11466-1124	RAD (ft.)	41	43	45	46 49	46 49	46 50	50	50	50	
Maroon 26 13/64"	R33: 11466-1026	GPM	5.90	6.50	7.05	7.55	8.00	8.45				
	R33LP: 11466-1126	RAD (ft.)	43	45	46	47	-	47	-	47	-	

Radius in feet. Measured indoors in no wind with plates mounted 18 inches above collection cups. The absence of data for a particular model/plate/nozzle combination indicates the pressure is outside the recommended range.

NELSON ROTATOR® ACCESSORIES

STREAM SPLITTERS

Part No.	Description	Price
11275	R10 (Blue) Two Sided Stream Splitter	
11285	R10 (Red) One Sided Stream Splitter	
9397	R2000 Stream Splitter	



ROAD GUARDS

Part No.	Description	Price
9590-030	R10, R2000(WF) Low Angle Road Guard (Red)	
9879	R10, R2000(WF) High Angle Road Guard (Orange)	
11363	R33 / R33LP Road Guard (Orange)	



TOOLS

Part No.	Description	Price
10634	R10, R2000(WF) 2TN Nozzle Removal Tool	
9620	R2000(WF) Plate Removal Tool	
9210	R2000(WF) Flush Tool	
10689	R2000(WF) Cap Removal Tool	
11473	33TN Nozzle Removal Tool	
11161	R33 Rotator Flush Tool	
11478	R33 Diffuser/ Motor/ Installation/ Removal Tool	
11417	R33 Lock Washer keeps the body secure on the Acme thread.	



INLET ADAPTERS ONLY

Part No.	Description	Price
9465	Male Acme x 3/8" MNPT	
9316	Male Acme x 1/2" MNPT	
9466	Male Acme x 3/4" MNPT	
10060-001	Male Acme x 1/2" PVC Slip	
10060-002	Male Acme x 3/4" PVC Slip	
10060-003	Male Acme x 25mm PVC Slip	
11344	R33/R33LP Male Acme x 3/4" MNPT	



MISCELLANEOUS

Part No.	Description	Price
9347	Security Screw Removal Tool	
9329	Security Screw	
10045	Internal Locking Device	
10649	R2000 Deflector Cap	
10398	R2000 Protector (Metal "Coyote Guard")	
9895-001	R2000 Web Guard	
10615	Thread Cap Shut-off for Acme Adapters	
10352	Female Acme x 1/2" PVC Spigot	
10367	Pressure Gauge Tap Assembly - Gauge Not Included	
11403	Keeper for MRDC / R2000 Acme Adapter	
9316-001	Keeper Assy. for MRDC / R2000 Acme Adapter	
11417	R33 Lock Washer keeps the body secure on the Acme thread.	



MISC. TOOLS & PARTS FOR 5MM AND 10MM ASSEMBLIES

Part No.	Description	Price
9195	Connector (CPSB) Converts FT2, FT4 & FT5 to 3/4" PVC Stake	
9284	*5mm Feedtube 1,000' (305 M) Coil	
9099	*10mm Feedtube 500' (152.4 M) Coil	
9813	Coupler 10mm - 3/4" PVC-10, FT4 & FT5	
9349	Punch Tool, 5mm Red (FT1 & FT2)	
9810	Punch Tool, 7mm Blue (FT4)	
9776	Punch Tool, 10mm White (FT5)	
9835-003	Drill Punch Tool, 5mm (FT1 & FT2)	
9835-002	Drill Punch Tool, 7mm (FT4)	
9835-001	Drill Punch Tool, 10mm (FT5)	
9845	Drill Installation Tool, (Installs #9739 Of FT5)	
9986	Dual Goof Plug for FT1 & FT2 (Must Order in 20's)	
9826	Plug, Rubber (Fits Inside of #9739 QC Barb)	
9831	Plug, Goof (Fits in Place of #9739 QC Barb)	
10287	Stake Installation Tool for the 6.3mm Stake	
10288	Stake Installation Tool for the 8mm Stake	
10301	Goof Plug for FT4	
10623	3/4 PVC-10, FT4 & FT5 1/2" Spigot x 10mm Compression	



AG - NELSON FEEDTUBE ASSEMBLIES

One of the most common ways to install D10, S10, R10 Series or R2000 Series Product is on a PVC riser extending from a permanent, often buried, lateral pipeline. However, because this is not always desirable considering cost, convenience, portability requirements and a host of other related issues, Nelson has developed several feedtube options. These versatile stake mounting options feature durable UV and kink resistant flexible PVC tubing. They provide for fast and simple installation, easy nozzle cleaning (kink the tubing to stop the flow), and low cost with a high value. The FT2 feedtube assembly is for use with the R10 due to the small .19" ID feedtube used in the assembly, which prohibits higher flow products. The FT4 and FT5 feedtube assemblies utilize a larger .37" ID flexible PVC feedtube and should be used for products requiring nozzle size #65 or larger. FT4 and FT5 feedtube assemblies connect R10 Series, R2000 Series, S10 and D10 products to polyethylene laterals. FT4 is for permanent connection and FT5 has a quick connect and disconnect feature for portable lateral systems. Both assemblies are mounted with steel stakes. With the addition of collar #9195 to FT4 and FT5, they can be converted to mount on a 3/4" PVC stake. Please call us if you have any questions which relate to these fine products.

1/2 PVC-5 FULL ASSEMBLIES FOR THE R5 & R10 (#40-60, .35 & .5FCN)



Part No.	Description	Price
11284-22130	PVC-5, 1/2" X 21" Stake, 5MM X 30" Tubing	
11284-22142	PVC-5, 1/2" X 21" Stake, 5MM X 30" Tubing	

1/2 PVC-5 STAKE ACCESSORIES

Part No.	Description	Price
11271	Adapter Assy, PV-5, Black - 5MM Tubing	
11283-030	Tubing Assy, Flexible, 5MM X 30" With LTO	
9305	LTO, 5MM Compression X Barb/LTO	
9284	Tubing, 5MM Flexible PVC- 1000' COIL	
9284-030	Tubing, 5MM X 30" Flexible PVC	
9284-072	Tubing, 5MM X 72" Flexible PVC	
11259-215	Stake, PVC, 1/2" X 15" Long Schedule 40	
11259-218	Stake, PVC, 1/2" X 18" Long Schedule 40	
11259-221	Stake, PVC, 1/2" X 21" Long Schedule 40	

FT2 FEEDTUBE ASSEMBLY FOR THE R10 #9741-030



- R10, Acme Base
- #9677 Steel Stake Adapter Acme Thread
- #9284-030 5mm Flexible PVC Feedtube Length = 30" (76cm) O.D. = .30" (7.6mm) I.D. = .19" (4.8mm) Bulk Coils #9284 = 1,000' (304M)
- #9305 LTO 5mm Compression x 5mm Barb
- #9726-024 6mm Steel Stake 18" (61cm)
- #10040-018 6mm Plastic Stake 18" (45cm)
- #10040-024 6mm Plastic Stake 24" (61cm)
- FT-2 TOTAL ASSEMBLED 9741-030 Does Not Include Stake

FT4 FEEDTUBE ASSEMBLY FOR THE R10, R10 TURBO, R2000, R2000WF, R2000LP, S10 & D10 #9752-036



- R10 (Acme), R10 Turbo (Acme), R2000, R2000WF, & R2000LP
- #9677 Steel Stake Adapter Acme Thread
- #9099-036 10mm Flexible PVC Feedtube Length = 36" (91cm) O.D. = .51" (13mm) I.D. = .37" (9.3mm) Bulk Coils #9099 = 500' (152M)
- #9774 LTO 10mm Compression x 7mm Barb
- #9725-024 8mm Steel Stake 24" (61cm)
- #10160-024 8mm Fiberglass Plastic Stake 24" (61cm)
- FT-4 TOTAL ASSEMBLED 9752-036 Does Not Include Stake

FT5 FEEDTUBE ASSEMBLY FOR THE R10, R10 TURBO, R2000, R2000WF, R2000LP, S10 & D10 #9737-048



- R10 (Acme), R10 Turbo (Acme), R2000, R2000WF & R2000LP
- #9677 Steel Stake Adapter Acme Thread
- #9099-048 10mm Flexible PVC Feedtube Length = 48" (122cm) O.D. = .51" (13mm) I.D. = .37" (9.3mm) Bulk Coils #9099 = 500' (152M)
- #9740 QC LTO 10mm Compression x Male QC
- #9739 QC Barb, Female QC x 10mm barb
- #9725-048 8mm Steel Stake 48" (122cm)
- FT-5 TOTAL ASSEMBLED 9737-048 Does Not Include Stake

RAIN BIRD® FULL CIRCLE SPRINKLERS

RAIN BIRD® LF800 FULL CIRCLE PLASTIC IMPACTS

Part No.	Nozzle Options	Deflector / Height	Radius/Flow @ 40 PSI	Price
LF08NXXZYY	White, 50 Drill .070"	6° Yellow / 12" - 21"	25' / .89 GPM	
LF08NXXZYY	Blue, 5/64"	9° Purple / 16" - 30"	28' / 1.12 GPM	
LF08NXXZYY	Orange, 44 Drill .086"	12° Copper / 27" - 41"	32' / 1.35 GPM	
LF08NXXZYY	Blue, 5/64"	15° Brown / 32" - 50"	31' / 1.12 GPM	



RAIN BIRD® LF1200 FULL CIRCLE PLASTIC IMPACTS

Part No.	Nozzle Options	Deflector / Height	Radius/Flow @ 40 PSI	Price
LF12NXXZYY	Orange, 44 Drill .086"	6° Dark Purple / 14" - 24"	26' / 1.35 GPM	
LF12NXXZYY	Blue, 5/64" .078"	10° White / 19" - 34"	26' / 1.12 GPM	
LF12NXXZYY	Orange, 44 Drill .086"	12° Canyon Blue / 28" - 40"	29' / 1.35 GPM	
LF12NXXZYY	Green, 7/64" .109"	12° Pink / 30" - 44"	34' / 2.15 GPM	
LF12NXXZYY	Purple, 3/32" .094"	16° Red / 39" - 59"	30' / 1.12 GPM	
LF12NXXZYY	Yellow, 38 Drill .102"	17° Powder Blue / 41" - 61"	36' / 1.89 GPM	
LF12NXXZYY	Yellow, 38 Drill .102"	21° Olive Green / 50" - 73"	36' / 1.89 GPM	



RAIN BIRD® LF2400 FULL CIRCLE PLASTIC IMPACTS

Part No.	Nozzle Options	Deflector / Height	Radius/Flow @ 40 PSI	Price
LF24NXXZYY	Tan, 30 Drill .117"	10° Lime / 24" - 41"	33' / 2.53 GPM	
LF24NXXZYY	Tan, 30 Drill .117"	13° Maroon / 30" - 50"	35' / 2.53 GPM	
LF24NXXZYY	Red, 1/8" .125"	15° Tangerine / 28" - 55"	37' / 2.89 GPM	
LF24NXXZYY	Black, 29 Drill .133"	22° Dk. Green / 59" - 102"	42' / 3.25 GPM	
LF24NXXZYY	Silver, 9/64" .143"	22° Dk. Green / 59" - 102"	44' / 3.78 GPM	
LF24NXXZYY	Silver, 9/64" .143"	27° Black / 76" - 116"	42' / 3.78 GPM	
LF24NXXZYY	Brown, 5/32" .156"	27° Black / 78" - 118"	44' / 4.60 GPM	
LF24NXXZYY	DK Grey, 11/64" .172"	27° Black / 80" - 120"	47' / 5.57 GPM	



XX = Deflector Angle Z = First Letter of Deflector Color YY = Nozzle Size
 All LF Series are 1/2" MIPT, Unless Designated as Acme Bodies by Changing the N in the Part No. to an A.
 Various Nozzle - Deflector Combinations are Available to Achieve the Flow & Radius that you need.
 The information included in the tables above show radius and flow information with randomly selected nozzle and deflector combination operated at 40 PSI.
 Call for Performance Charts. Edge Guard, Splash Guard, Stream Splitter and Other Accessories Available.

RAIN BIRD® FULL CIRCLE IMPACTS

Part No.	Description	Price
M20VH-PM	1/2" Brass Wedge Drive Impact Male Brass Nozzle 15°	
A01619	14 VH Wedge Drive 1/2" Male Brass Single Nozzle 23°	
A06240	L20VH Wedge Drive 1/2" Male Brass Single Nozzle 10°	
A06015	L20H 1/2" Male Brass Single Nozzle 23°	
A05840	20JH 1/2" Male Brass Single Nozzle 23°	
A0231108	20ADJB08 1/2" Male Brass w/ Distance Control Diffuser Pin w/ Noz.	
A06501	29JH 1/2" Male Brass Single Nozzle 23°	
A07360	L36H 3/4" Male Plastic w/ Brass Brg. Sleeve, Slotted Spoon 10°	
A07350	L36AH 3/4" Male Plastic w/ Brass Brg. Sleeve, Regular Spoon 10°	
A11640	L3030H 3/4" Male Brass Double Nozzle 10°	
L46000	46H 3/4" Male Plastic Double Nozzle 23°	
A08401	30H 3/4" Male Brass Double Nozzle 27°	
A08411	30WH 3/4" Male Brass Single Nozzle 27°	
A11355	30PWH 3/4" Male Brass Aluminum Arm, Single Nozzle 27°	
A12800	14070H 3/4" Male Brass Double Nozzle 27°	
A08401F	30FH 3/4" Male Brass Frost Protection, Double Nozzle 27°	
A08901F	30FWH 3/4" Male Brass Frost Protection, Single Nozzle 27°	
A20000	70CH 1" Female Brass Double Nozzle 21°	
A20030	70CHM 1" Male Brass Double Nozzle 21°	
A23802	80EHD 1-1/4" Male Brass Double Nozzle 27°	



Less Nozzle Unless Noted

INTRO 1. ELECTRICAL 2. PUMP, ACC. 3. HOSE, PE PIPE & ACC. 4. IPS, PIP PIPE & ACC. 5. SURFACE 6. SPRINKLERS 7. TRAVELER & WHEEL MOVE 8. PIVOT 9. TURF 10. LOW VOLUME 11. FILTERS 12. INJECTION 13. HARDWARE INDEX

FULL CIRCLE IMPACT SPRINKLERS

NELSON FULL CIRCLE IMPACTS

Part No.	Description	Price
7185-210	L20-04T 3/4" Male Brass Single Nozzle 9°	
6902	F33AS 3/4" Male Brass Single Nozzle 15°	
6717	F33AA 3/4" Male Brass Double Range Nozzle 15°	
8718	F44AAB 3/4" Male Plastic Double Range Nozzle 8°	
6903	F43A 3/4" Male Brass Double Nozzle 15°	
7316	F70M 1" Male Brass Double Nozzle 25°	
7118	F70AM 1" Male Brass Double Nozzle 15°	
8732	F80 1-1/4" Male Brass Double Nozzle 24°	
7155	F80A 1-1/4" Male Brass Double Nozzle 18°	



Less Nozzle

JAIN 5022 FULL CIRCLE PLASTIC IMPACTS

Part No.	Model	Description	Price
16052701	21152701	1/2" Male Single 3/32" Purple Nozzle	
16052702	21152702	1/2" Male Single 7/64" Orange Nozzle	
16052703	21152703	1/2" Male Single 15/128" Red Nozzle	
16052704	21152704	1/2" Male Single 1/8" Green Nozzle	
16052705	21152705	1/2" Male Single 9/64" Blue Nozzle	
16052706	21152706	1/2" Male Single 5/32" Black Nozzle	



WADE RAIN FULL CIRCLE BRASS IMPACTS

Part No.	Description	Price
WR-33-P	3/4" Male Single Nozzle x Plug	
WR-33	3/4" Male Range Nozzle x Spreader Nozzle	
WR-32-P	3/4" Male Single Nozzle x Plug, Aluminum Arm	
WR-32	3/4" Male Range Nozzle x Spreader Nozzle, Aluminum Arm	



WEATHER-TEC FULL CIRCLE BRASS IMPACTS

Part No.	Description	Price
10-20G	1/2" Male Single Nozzle 23° with Nozzle	
10-20LJN	1/2" Male Single Nozzle LA Cow Washer with Nozzle & Boot	
10-22LJN	1/2" Male Double Nozzle LA Cow Washer with Nozzle & Boot	
G50-23	3/4" Male Die-Cast Single Nozzle 23° with Nozzle	
10-30G	3/4" Male Single Nozzle 23° with Nozzle	
10-30DG	3/4" Male Double Nozzle 23° with Nozzle	
10-30LDG	3/4" Male Double Nozzle 15° with Nozzle	
10-67G	1" Male Single Nozzle 23° with Nozzle	
10-80K	1-1/4" Male Single Nozzle with Nozzle	



XCAD AQUA BURST® FULL CIRCLE IMPACTS

Part No.	Description	Nozzle Guide	Price
AL1023	1/2" Male Multi-Composite Single Nozzle 10° or 23°	NOZ5R	
AL1023W	1/2" Male Multi-Composite Wedge Drive Single Nozzle 10° or 23°	NOZ5R	
HF20	1/2" Male Brass W/ Noz (7/64, 9/64, 1/8)	NOZ75	
HF30	3/4" Male Brass Single Nozzle 23°	NOZ75, NOZPL75	
HF30-C	3/4" Brass Arm, Single Nozzle W/Chrome Bearing	NOZ75	
HF30D	3/4" Male Brass Double Nozzle 26°	NOZ75	
HF30D-C	3/4" Brass Arm, Double Nozzle W/Chrome Bearing	NOZ75	
HF30AL	3/4" Male Brass Aluminum Arm Single Nozzle 26°	NOZ75, NOZPL75	
AL30	3/4" Multi-Composite Double Noz. 26°	NOZ75, NOZPL75	
X65F-S	1" Male Brass Single Nozzle 24° with Spoon	NOZ1	
X85F24	1-1/4" Male Brass Single Nozzle 24°	NOZ125	



PART OR FULL CIRCLE IMPACT SPRINKLERS

RAIN BIRD® PART OR FULL CIRCLE IMPACTS

Part No.	Description	Price
B46100-08	2045-PJ-AG 1/2" Male Plastic Impact with 1/8" Nozzle	
A34403-10	25BPJ-FP-ADJ-DA-TNT 1/2" Male Brass Impact, PJ Arm, with Diffuser & Distance Control and 5/32" Nozzle	
A32901-XX	25B-PJ-FP-ADJ 1/2" Male Brass Impact with PJ Arm, Adjustable Breakup Pin, and SBN Nozzle	
A39200	35A-TNT 3/4" Male Brass Impact Less Nozzle	
A4061312	35A-PJ-ADJ-TNT 3/4" Male Brass Impact with PJ Arm & ADJN-3 #12 (3/16") Nozzle	
AG2001	65PJ-TNT 1" Female Brass Impact with PJ Arm, Less Nozzle	
A23600	85EHD 1-1/4" Male Brass Impact, Less Nozzles 27°	
A23960	85EHD-LA 1-1/4" Male Brass Low Angle Impact, Less Nozzle 17°	



XCAD AQUA BURST® PART OR FULL CIRCLE IMPACTS

Part No.	Description	Nozzle	Price
X25ED	1/2" Male Multi-Composite Adjustable W/ Anti-Backsplash Arm	NOZ5R	
X25EDS	1/2" Male Multi-Composite Adjustable W/ Standard Spoon	NOZ5R	
X35ED	3/4" Male Brass Adjustable	NOZ75, NOZPL75	
X65ED-S	1" Male Brass Adjustable W/ Standard Spoon	NOZ1	
X85ED18	1-1/4" Male Brass Adjustable 18°	NOZ125	
X85ED24	1-1/4" Male Brass Adjustable 24°	NOZ125	



LR NELSON® BETA PART OR FULL CIRCLE PLASTIC IMPACTS

Part No.	Description	Price
1372	1/2" Male 1.9 - 2.7 GPM (Green Nozzle)	
1373	1/2" Male 2.9 - 4.0 GPM (Red Nozzle)	
1374	1/2" Male 3.6 - 5.2 GPM (Black Nozzle)	

Plastic - Full or Part Circle



NELSON PART OR FULL CIRCLE BRASS IMPACTS

Part No.	Description	Price
8805	P65M 1" Male Single Nozzle 24°	
8426	P85 1-1/4" Male Double Nozzle 24°	
7697	P85A 1-1/4" Male Double Nozzle 18°	
8079	P85AS 1-1/4" Male Single Nozzle 18°	

Less Nozzle



WEATHER-TEC PART OR FULL CIRCLE BRASS IMPACTS

Part No.	Description	Price
15-20KAFP	1/2" Male Single Nozzle 23° with Nozzle	
15-20LFP	1/2" Male Single Nozzle LA with Nozzle	
15-30KFP	3/4" Male Single Nozzle 27° with Nozzle	
15-67KAFP	1" Male Double Nozzle 23° with Nozzle	
15-80KFP	1-1/4" Male Double Nozzle 23° with Nozzle	
15-80LK	1-1/4" Male Double Nozzle 15° with Nozzle	
3522	3" Male Rocker Gun 22° with Nozzle	



NELSON NOZZLES, VANES & ACCESSORIES

Part No.	Description	Price
2RN	Brass Nozzle for L20-04T	
3RN	Brass Nozzle for 3/4" Impacts	
2FCN	Flow Control Nozzle for L20-04T	
3FCN	Flow Control Nozzle for F33AS, F33AA & F44AAB	
7RN	Drive Nozzle F70M, F70AM & P65M	
8DRN	Drive Nozzle F80, F80A, P85, P85A & P85AS	
3RNPLUG	Brass Secondary Plug for F70A, F80A, P85, F44AAB	
3V	Stream Straightener for F33AS & F33AA	
4V	Stream Straightener for F44AAB & F43A	
7V	Stream Straightener for F70M, F70AM & P65M	
8V	Stream Straightener for all 80 & 85 Series Impacts	
8ADN	Adjustable Diffuser Assembly (Including Nozzle)	
8DN	Diffuser Assembly Only (No Nozzle)	
7198	F70 1" FC Bearing Assembly	
7197	F80 1-1/4" FC Bearing Assembly	
8806	P65 1" PC Bearing Assembly	
9036	P85 1-1/4" PC Bearing Assembly	
7714	P85A & P85AS 1-1/4" PC LA Bearing Assembly	



RAIN BIRD® NOZZLES & ACCESSORIES

Part No.	Description	Price
100225-xx	LAN-1-7 Brass 7° Low Angle Nozzle 1/2" Body	
100226-xx	LAN-1-20 Brass 20° Low Angle Nozzle 1/2" Body & Spreader Nozzle for 3/4" Bodies & 808A	
105780-xx	SBN-1 Brass Straight Bore Nozzle for 1/2" Body	
106160-xx	SBN-1V Brass Straight Bore Nozzle w/Vane for 1/2" Body	
105842-xx	SBN-3 Brass Straight Bore Nozzle for 3/4" Body	
106131-xx	SBN-3V Brass Straight Bore Nozzle w/Vane for 3/4" Body	
100382-xx	SBN-4 Brass Straight Bore Nozzle for 1" Body	
103043-xx	SBN-5 Brass Straight Bore Nozzle for 1-1/4" Body	
100418	SPB-1 Spreader Bushing for 1" Body	
105816	NV-3 Nozzle Vane for 3/4" Body	
101092-xx	ADJN-1V Brass Adjustable Nozzle w/Vane for 1/2" Body	
100328-xx	ADJN-3 Brass Adjustable Nozzle for 3/4" Body	
100385-xx	ADJN-4 Brass Adjustable Nozzle for 1" Body	
100332-xx	DAN-3 Brass Do-All Nozzle for 3/4" Body	
100255	Brass Plug for 1/2" Body	
100289	Brass Plug for 3/4" Body (Range)	
100417	Brass Plug for 1" Body (Spreader Side)	
177535	1/2" FC Bearing Assembly for 14VH	
177535	1/2" FC Bearing Assembly for L20VH	
177422	1/2" FC Bearing Assembly for 20JH, L20H	
104919	1/2" FC Bearing Assembly for 29JH	
105833	3/4" FC Bearing Assembly for 46H	
177423	1/2" FC Bearing Assembly for M20VH-PM	
177424	3/4" FC Bearing Assembly for 30H, 14070H, L3030H	
110048	3/4" FC Bearing Assembly for 30TNT	
177514	1" FC Bearing Assembly for 70CH Female	
177512	1" FC Bearing Assembly for 70CH Male	
177427	1-1/4" FC Bearing Assembly for 80EH, 80EHD, LA	
110950	1/2" PC Bearing Assembly for 25BPJ-FP-ADJ	
177473	3/4" PC Bearing Assembly for 35A-TNT	
177475	1" PC Bearing Assembly for 65PJ-TNT	
177474	1-1/4" PC Bearing Assembly for 85EHD, 85EHD-LA	



JAIN NOZZLES

Part No.	Description	Price
17582251	#12 3/32" Purple Nozzle (Jain 5022 Sprinkler Nozzles)	
17582281	#14 7/64" Orange Nozzle (Jain 5022 Sprinkler Nozzles)	
17582301	#15 15/128" Red Nozzle (Jain 5022 Sprinkler Nozzles)	
17582321	#16 1/8" Green Nozzle (Jain 5022 Sprinkler Nozzles)	
17582351	#18 9/64" Blue Nozzle (Jain 5022 Sprinkler Nozzles)	
17582401	#20 5/32" Black Nozzle (Jain 5022 Sprinkler Nozzles)	
17582001	Black Rear Plug (Jain 5022 Sprinkler)	



XCAD AQUA BURST® NOZZLES & ACCESSORIES

XCAD AQUA BURST® ADVANCED FLOW NOZZLES & ACCESSORIES

Part No.	Description	Price
NOZ5R	Brass Straight Bore Nozzle for 1/2" Impacts Fits Aqua Burst® AB20 Series	
NOZ5W	Brass Straight Bore Nozzle for 1/2" Impacts Fits Aqua Burst® RB Series	
NOZ75	Brass Straight Bore Nozzle for 3/4" Impacts Including 1/2" Aqua Burst® RB29F	
NOZ1	Brass Straight Bore Nozzle for 1" Impacts	
NOZ-BKSPRD	Brass Spreader Nozzle 1/8" NPT (3/32" or 1/8")	
NOZPL75	1/4" NPT Straight Bore Nozzle	
NOZ-PLG18	Brass Plug 1/8" NPT	
NOZ-PLG25	Brass Plug 1/4" NPT	
NOZPLPLG18	Plastic Plug 1/8" NPT	
NOZPLPLG25	Plastic Plug 1/4" NPT	
NOZ125	Fits 1-1/4" Impact 11/32, 3/8, 13/32, 7/16, 15/32, 1/2", 17/32, 9/16, 5/8, 11/16	
HF20BRNG	Brass Bearing Assembly for 1/2" AB Series	
HF30BRG	Brass Bearing Assembly for 3/4" Impacts	
X65BRNG	Brass Bearing Assembly for 1" Impacts	
X85BRG	1-1/4" Bearing Assembly, Fits Aqua Burst & Rainbird	



XCAD AQUA BURST NOZZLE MULTI-TOOL

Part No.	Description	Price
NOZTOOL	Nozzle Tool for 3/4" Sprinkler	
NOZTOOL.5	Nozzle Tool for 1/2" Sprinkler	

Nozzle Tool Features:

- All stainless steel construction
- EZ grip handles
- Stainless steel nozzle plug wire
- NOZTOOL fits nozzles with 3/8", 7/16", 1/2", and 3/4" hex heads
- NOZTOOL.5 fits nozzles with 3/8" and 7/16" hex heads

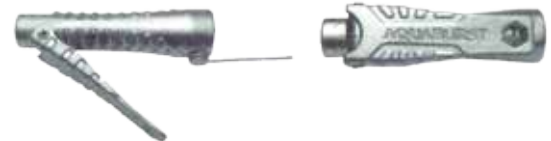

ROAD GUARDS (MADE IN THE USA)

Part No.	Description	Price
RGS75P	Wheeline / Leveler	
RGCS100	Handline / Riser	



1. ELECTRICAL 2. PUMP Acc. 3. HOSE, PE PIPE & Acc. 4. IPS, PIP Pipe & Acc. 5. SURFACE 6. SPRINKLERS 7. TRAVELER & WHEEL MOVE 8. PIVOT 9. TURF 10. LOW VOLUME 11. FILTERS 12. INJECTION 13. HARDWARE INDEX

SPRINKLER RISERS

GALVANIZED SPRINKLER RISERS

Part No.	Size	Length	Price
RISER-06	1" MIPT x 3/4" FIPT	6"	
RISER-12		12"	
RISER-15		15"	
RISER-18		18"	
RISER-21		21"	
RISER-24		24"	
RISER-28		28"	
RISER-30		30"	
RISER-36		36"	



ALUMINUM SPRINKLER RISERS

Part No.	Size	Length	Price
RAL-112-006	1" MIPT x 3/4" FIPT	6"	
RAL-112-012		12"	
RAL-112-018		18"	
RAL-112-024		24"	
RAL-112-030		30"	
RAL-112-036		36"	

ACCESSORIES

PVC SOLID SET SYSTEM (SPIKE COUPLER)

Part No.	Description	Price
SC200	2" Male x 2" Female Set Complete with Aluminum Spike	



WEBSTER MATIC SPRINKLER QUICK COUPLING RISER VALVE

Part No.	Description	Price
WM-2-050-LAWN	1/2" Riser Valve w/Cover	
WM-2-050-AG	1/2" Riser Valve w/Out Cover	
WM-6-075-LAWN	3/4" Riser Valve w/Cover	
WM-6-075-AG	3/4" Riser Valve w/Out Cover	
WM-6-100-LAWN	1" Riser Valve w/Cover	
WM-6-100-AG	1" Riser Valve w/Out Cover	
WM-6-125-LAWN	1-1/4" Riser Valve w/Cover	
WM-6-125-AG	1-1/4" Riser Valve w/Out Cover	



SENNINGER® FULL CIRCLE PLASTIC IMPACT SPRINKLERS

SENNINGER® PIVOT MASTER FULL CIRCLE IMPACTS - 6°

Part No.	Description	Price
3006H-1-3/4"-M-PM	3/4" Male Single Noz. 6° w/Brass Swivel (Less Noz.)	
4006H-1-3/4"-M-PM	3/4" Male Single Noz. 6° w/Brass Swivel (Less Noz.)	
5006H-1-3/4"-M-PM	3/4" Male Single Noz. 6° w/Brass Swivel (Less Noz.)	
4006H-2-3/4"-M-PM	3/4" Male Double Noz. 6° w/Brass Swivel (Less Noz.)	
5006H-2-3/4"-M-PM	3/4" Male Double Noz. 6° w/Brass Swivel (Less Noz.)	



SENNINGER® PIVOT MASTER FULL CIRCLE IMPACTS - 12°

Part No.	Description	Price
3012H-1-3/4"-M-PM	3/4" Male Single Noz. 12° w/Brass Swivel (Less Noz.)	
4012H-1-3/4"-M-PM	3/4" Male Single Noz. 12° w/Brass Swivel (Less Noz.)	
5012H-1-3/4"-M-PM	3/4" Male Single Noz. 12° w/Brass Swivel (Less Noz.)	
7012SD-2-1"-F	1" Female Double Noz. 12° w/Plastic Swivel (Less Noz.)	



SENNINGER® FULL CIRCLE - SINGLE NOZZLE IMPACTS - 23° & 25°

Part No.	Description	Price
2023HS-1-1/2"-M	1/2" Male Single Noz. 23° (Less Noz.)	
3023-1-3/4"-M	3/4" Male Single Noz. 23° (Less Noz.)	
4023-1-3/4"-M	3/4" Male Single Noz. 23° (Less Noz.)	
5023-1-3/4"-M	3/4" Male Single Noz. 23° (Less Noz.)	
7025RD-1-1"-M	1" Male Single Noz. 25° (Less Noz.)	
8025HR-1-1-1/4"-M	1-1/4" Male Single Noz. 25° (Less Noz.)	



SENNINGER® FULL CIRCLE - DOUBLE NOZZLE IMPACTS - 23° & 25°

Part No.	Description	Price
3023-2-3/4"-M	3/4" Male Double Noz. 23° (Less Noz.)	
4023-2-3/4"-M	3/4" Male Double Noz. 23° (Less Noz.)	
5023-2-3/4"-M	3/4" Male Double Noz. 23° (Less Noz.)	
7025RD-2-1"-M	1" Male Double Noz. 25° (Less Noz.)	
8025HR-2-1-1/4"-M	1-1/4" Male Double Noz. 25° (Less Noz.)	



SENNINGER® NOZZLES, VANES & ACCESSORIES

Part No.	Description	Price
NZINXX	Noz. for 20, 30, 40 & 50 Series Impacts #6 - #18 (3/32" - 9/32") & Spreader Noz. for 70 & 80 Series #7 - #18 (7/64" - 9/32")	
NZVXX	Nozzle - Vane Combination #6 - #10 (3/32" - 5/32") for 20, 30 & 40	
70NZXX	Range Noz. for 70 Series #14 - #24 (7/32" - 3/8")	
80NZXX	Range Noz. for 80 Series #24 - #40 (3/8" - 5/8")	
VNW	White Regular Vane (Maximizes Throw)	
VNR	Red Spiral Vane (Improves Uniformity at Low Pressure)	
VNB	Blue Barrel Vane (Large Passageway to Reduce Clogging)	
VN72	Blue-Green Range Noz. Vane for 70 Series (Maximizes Throw)	
VN75E	Pink Range Noz. Vane for 70 Series (Effluent Vane, Large Passage)	
VN85	Black Range Noz. Vane for 80 Series (Large Passageway, Minimizes Clogging)	
80NEX	Range Nozzle Extension, 8025SD-2	



INTRO
 1. ELECTRICAL
 2. PUMP ACC.
 3. HOSE, PE PIPE & ACC.
 4. IPS, PIP PIPE & ACC.
 5. SURFACE
 6. SPRINKLERS
 7. TRAVELER & WHEEL MOVE
 8. PIVOT
 9. TURF
 10. LOW VOLUME
 11. FILTERS
 12. INJECTION
 13. HARDWARE
 INDEX

SENNINGER® PART CIRCLE PLASTIC IMPACT SPRINKLERS

MODEL 3123 (NOZZLES #8 - #10)

Part No.	Description	Price
3123PC-1-3/4"M	3/4" Male Plastic Swivel	
3123PC-1-3/4"F	3/4" Male Plastic Swivel with 3/4" Coupling	
3123PC-1-1"F	3/4" Male Plastic Swivel with 1" x 3/4" Coupling	

MODEL 4123 (NOZZLES #10 - #13)

Part No.	Description	Price
4123PC-1-3/4"M	3/4" Male Plastic Swivel	
4123PC-1-3/4"F	3/4" Male Plastic Swivel with 3/4" Coupling	
4123PC-1-1"F	3/4" Male Plastic Swivel with 1" x 3/4" Coupling	

MODEL 5123 (NOZZLES #13 - #18)

Part No.	Description	Price
5123PC-1-3/4"M	3/4" Male Plastic Swivel	
5123PC-1-3/4"F	3/4" Male Plastic Swivel with 3/4" Coupling	
5123PC-1-1"F	3/4" Male Plastic Swivel with 1" x 3/4" Coupling	

Note: All Sprinklers Priced Less Nozzles



LIMITED AVAILABILITY - PLEASE CALL FOR AVAILABLE SPRINKLER OPTIONS

SENNINGER® 23° F-LUENT® IMPACTS

SENNINGER® FULL CIRCLE - SINGLE NOZZLE F-LUENT® IMPACTS (FOR WASTEWATER)

Part No.	Description	Price
3023-1-3/4F-EFF	3/4" Female, Full Circle, Plastic Base, Nozzle Range 7-10	
4023-1-3/4F-EFF	3/4" Female, Full Circle, Plastic Base, Nozzle Range 10-14	
4023-1-3/4M-EFF	3/4" Male, Full Circle, Plastic Base, Nozzle Range 10-14	
5023-1-3/4F-EFF	3/4" Female, Full Circle, Plastic Base, Nozzle Range 13-18	
5023-1-3/4M-EFF	3/4" Male, Full Circle, Plastic Base, Nozzle Range 13-18	
7025-1-1F-EFF	1" Female, Full Circle, Plastic Base, Nozzle Range 14-24	
7025-1-1M-EFF	1" Male, Full Circle, Plastic Base, Nozzle Range 14-24	
8025-1-1.25F-EFF	1-1/4" Female, Full Circle, Plastic Base, Nozzle Range 24-40	
8025-1-1.25M-EFF	1-1/4" Male, Full Circle, Plastic Base, Nozzle Range 24-40	

Note: All Sprinklers Priced Less Nozzles



NELSON BIG GUN SPRINKLERS

Part No.	Description	Price
10279-118	F75 x 18° x 2" Full Circle w/HD Lower Bearing	
10279-121	F75 x 21° x 2" Full Circle w/HD Lower Bearing	
10279-124	F75 x 24° x 2" Full Circle w/HD Lower Bearing	
10229-118	SR75 x 18° x 2" Part Circle w/HD Lower Bearing	
10229-121	SR75 x 21° x 2" Part Circle w/HD Lower Bearing	
10229-124	SR75 x 24° x 2" Part Circle w/HD Lower Bearing	
8211-038	F100 x 18° x 2" Full Circle w/HD Lower Bearing	
8211-042	F100 x 21° x 2" Full Circle w/HD Lower Bearing	
8211-046	F100 x 24° x 2" Full Circle w/HD Lower Bearing	
8211-147	QC-F100 x 24° Full Circle w/Integral Valve Key	
8211-098	SR100 x 18° x 2" Part Circle w/HD Lower Bearing	
8211-102	SR100 x 21° x 2" Part Circle w/HD Lower Bearing	
8211-106	SR100 x 24° x 2" Part Circle w/HD Lower Bearing	
8211-143	QC-SR100 x 24° Part Circle w/Integral Valve Key	
8211-110	SRNV100E x 18° Part Circle w/Solenoid	
9643	SRNV100H x 18° x 2" Part Circle w/out Solenoid	
10338-001	SRA100 Adjustable Trajectory - 2" FNPT or FBSP	
9455-021	F150 x 21° Full Circle - Flanged Connection	
9455-024	F150 x 24° Full Circle - Flanged Connection	
8463-221	SR150 x 21° Part Circle - Flanged Connection	
8463-224	SR150 x 24° Part Circle - Flanged Connection	
9292-001	SR150 x 43° Part Circle - Flanged Connection	
10055-001	SRA150 Adjustable Trajectory - Flanged Connection	
6080	F200 x 21° Full Circle - Flanged Connection	
6260	F200 x 24° Full Circle - Flanged Connection	
6000	F200 x 27° Full Circle - Flanged Connection	
9192-021	SR200 x 21° Part Circle - Flanged Connection	
9192-024	SR200 x 24° Part Circle - Flanged Connection	
9192-027	SR200 x 27° Part Circle - Flanged Connection	
(1)	for Anodized F100 or SR100 add	
(2)	for Anodized & Powder Coated F100 or SR100 add	
(3)	for Anodized F150 or SR150 add	
(4)	for Anodized & Powder Coated F150 or SR150 add	
(5)	for Anodized SR200 add	
(6)	for Anodized & Powder Coated SR200 add	

Note: Heavy Duty Bearing is standard on all Big Gun Sprinklers.
Coating options not available for F200.



TRAJECTORIES AVAILABLE

Big Gun®	Trajectory Angle
75 SERIES	18°, 21°, 24°, 43°
100 SERIES	18°, 21°, 24°, 43°, 15°- 45° Adjustable
150 SERIES	21°, 24°, 27°, 43°, 15°- 45° Adjustable
200 SERIES	21°, 24°, 27°

CONNECTIONS AVAILABLE

Big Gun®	Size Connections
75 SERIES	1-1/2", 2" FNPT, ANSI/DIN, Nelson, Metric
100 SERIES	2" or 2-1/2" FNPT & ANSI/DIN, Nelson, Metric
150 SERIES	3" or 3-1/2" FNPT x Flange & ANSI/DIN, Nelson, Metric
200 SERIES	3-1/2" or 4" FNPT x Flange & ANSI/DIN, Nelson, Metric



INTRO
1. ELECTRICAL
2. PUMP ACC.
3. HOSE, PE PIPE & ACC.
4. IPS, PIP PIPE & ACC.
5. SURFACE
6. SPRINKLERS
7. TRAVELER & WHEEL MOVE
8. PIVOT
9. TURN
10. LOW VOLUME
11. FILTERS
12. INJECTION
13. HARDWARE
INDEX

NELSON BIG GUN® NOZZLES & ACCESSORIES

75 SERIES TAPER RING

Part No.	Description	Price
10208-040	TR75 .40"	
10208-045	TR75 .45"	
10208-050	TR75 .50"	
10208-055	TR75 .55"	
10208-060	TR75 .60"	
10208-065	TR75 .65"	
10208-070	TR75 .70"	
10208-075	TR75 .75"	
10208-080	TR75 .80"	
10207	Noz. Cap Only	



100 SERIES TAPER BORE NOZZLES

Part No.	Description	Price
9309-050	100T .50"	
9309-055	100T .55"	
9309-060	100T .60"	
9309-065	100T .65"	
9309-070	100T .70"	
9309-075	100T .75"	
9309-080	100T .80"	
9309-085	100T .85"	
9309-090	100T .90"	
9309-100	100T 1.0"	



100 SERIES RING NOZZLES

Part No.	Description	Price
6749	100R Ring Nozzle Set	
7872	Ring Nozzle Cap Only (use only with 100R)	
6745	Ring Nozzle Cap Only (use only with 100TR)	
9956-001	Ring or Taper Ring Nozzle Body Only	
6847	Set of 7 Rings Only	
6738-060	R100 .60" Individual Ring Only	
6738-071	R100 .71" Individual Ring Only	
6738-077	R100 .77" Individual Ring Only	
6738-081	R100 .81" Individual Ring Only	
6738-086	R100 .86" Individual Ring Only	
6738-089	R100 .89" Individual Ring Only	
6738-093	R100 .93" Individual Ring Only	
6738-096	R100 .96" Individual Ring Only	

Note: Add 15% for Anodized 100 Series Nozzles.
Add 60% for Anodized & Powder Coated 100 Series Nozzles



100 SERIES TAPER RINGS

Part No.	Description	Price
9237-016	TR100 .63" Individual Taper Ring 16MM	
9237-017	TR100 .67" Individual Taper Ring 17MM	
9237-018	TR100 .71" Individual Taper Ring 18MM	
9237-019	TR100 .75" Individual Taper Ring 19MM	
9237-020	TR100 .79" Individual Taper Ring 20MM	
9237-021	TR100 .83" Individual Taper Ring 21MM	
9237-022	TR100 .87" Individual Taper Ring 22MM	
9237-023	TR100 .91" Individual Taper Ring 23MM	
9237-024	TR100 .95" Individual Taper Ring 24MM	



150 SERIES TAPER BORE NOZZLES

Part No.	Description	Price
9317-070	150T .70" Taper Bore Nozzle	
9317-080	150T .80" Taper Bore Nozzle	
9317-090	150T .90" Taper Bore Nozzle	
9317-100	150T 1.0" Taper Bore Nozzle	
9317-110	150T 1.1" Taper Bore Nozzle	
9317-120	150T 1.2" Taper Bore Nozzle	
9317-130	150T 1.3" Taper Bore Nozzle	
9317-140	150T 1.4" Taper Bore Nozzle	



150 SERIES RING NOZZLES

Part No.	Description	Price
6790	150R Ring Nozzle Set	
6286	Ring Nozzle Cap Only	
9773	Ring Nozzle Body Only	
6846	Set of 7 Rings Only	
6287-086	R150 .86" Individual Ring Only	
6287-097	R150 .97" Individual Ring Only	
6287-108	R150 1.08" Individual Ring Only	
6287-118	R150 1.18" Individual Ring Only	
6287-126	R150 1.26" Individual Ring Only	
6287-134	R150 1.34" Individual Ring Only	
6287-141	R150 1.41" Individual Ring Only	
6287-147	R150 1.47" Individual Ring Only	

Note: Add 10% for Anodized 150 Series Nozzles.
Add 40% for Anodized & Powder Coated 150 Series Nozzles



150 SERIES TAPER RINGS

Part No.	Description	Price
9238-022	TR150 22MM (.87")	
9238-024	TR150 24MM (.95")	
9238-026	TR150 26MM (1.02")	
9238-028	TR150 28MM (1.10")	
9238-030	TR150 30MM (1.18")	
9238-032	TR150 32MM (1.26")	
9238-034	TR150 34MM (1.33")	



200 SERIES TAPER BORE NOZZLES

Part No.	Description	Price
9323-105	200T 1.05"	
9323-110	200T 1.10"	
9323-120	200T 1.20"	
9323-130	200T 1.30"	
9323-140	200T 1.40"	
9323-150	200T 1.50"	
9323-160	200T 1.60"	
9323-175	200T 1.75"	
9323-190	200T 1.90"	



200 SERIES RING NOZZLES

Part No.	Description	Price
6789	200R Ring Nozzle Set	
9972-001	Ring Nozzle Body, Only	
6026	Ring Nozzle Cap, Only	
6845	Set of 7 Rings Only	
6027-129	R200 1.29" Individual Ring Only	
6027-146	R200 1.46" Individual Ring Only	
6027-156	R200 1.56" Individual Ring Only	
6027-166	R200 1.66" Individual Ring Only	
6027-174	R200 1.74" Individual Ring Only	
6027-183	R200 1.83" Individual Ring Only	
6027-193	R200 1.93" Individual Ring Only	



Add 7% for Anodized 200 Series Nozzles. Add 27% for Anodized & Powder Coated 200 Series Nozzles.

100 SERIES HEAVY-DUTY LOWER BEARING

Part No.	Description	Price
7863	2" FNPT Full Circle Bearing Assembly	
7864	1-1/2" FNPT Full Circle Bearing Assembly	
7862	Flanged Full Circle Bearing Assembly	
7273	2" Part Circle Bearing Assembly	
7277	2-1/2" Part Circle Bearing Assembly	
7753	Flanged Part Circle Bearing Assembly	
10265-201	ANSI Flanged, Full Circle Bearing Assembly	
10265-001	ANSI Flanged, Part Circle Bearing Assembly	
7950	2" FNPT Part Circle Nozzle Valve Bearing Assy.	



150 & 200 SERIES LOWER BEARING ASSEMBLY

Part No.	Description	Price
8458	150 Series Lower Bearing Assembly Flg. Conn.	
10323-001	150 Series Lower Bearing Assembly ANSI Conn.	
9114-000	200 Series Lower Bearing Assembly Flg. Conn.	
9114-003	200 Series Lower Bearing Assembly ANSI Conn.	



BIG GUN® ACCESSORIES

Part No.	Description	Price
8403-001	150FI 3" FNPT x Flange Adapter	
6621-00	200FI 3 1/2" FNPT x Flange Adapter	
9127	200FI 4" FNPT x Flange Adapter	
9724	Secondary Nozzle Kit	
9822	SR100 & SR150 Drive Arm Maintenance Kit	
9857	SR100 LPV Kit (low pressure drive vane)	
6671	600V Stream Straightener Vane (fits 2" x 6" riser)	
8386	100CBK Series Counter Balance Kit	
8399	150CBK Series Counter Balance Kit	
11090	75 Drive Arm Maintenance Kit	
10088-###	100FI 2" or 2-1/2" FNPT x Flanged Adapter	
10565	ANSI Flange Adapter (F200 Only)	



TURBINE DRIVE SPRINKLER GUNS

PERFORMANCE CHART - GEMINI			
Nozzle Size	PSI	Jet Length Ft.	GPM
32mm 1-1/4"	70	184	424
	85	192	464
	100	202	500
	115	213	536
34mm 1-11/32"	70	190	472
	85	199	518
	100	210	558
	115	220	598
36mm 1.42"	70	199	525
	85	210	574
	100	220	620
	115	229	664
38mm 1-1/2"	70	217	635
	85	229	685
	100	236	733
	115	246	777
40mm 1.57"	70	223	698
	85	236	753
	100	244	806
	115	255	855



GEMINI - DUAL SPEED

400-855 GPM
Adjustable Gears for Variable Speed Rotation
Flanged Connection

Price

PERFORMANCE CHART - MARINER			
Nozzle Size	PSI	Jet Length Ft.	GPM
26mm 1"	44	137	193
	56	154	223
	70	168	250
	85	177	274
28mm 1.1"	44	147	224
	56	160	259
	70	170	289
	85	181	317
30mm 1-3/16"	56	164	257
	70	177	297
	85	187	332
	100	199	364
32mm 1-1/4"	56	170	338
	70	184	378
	85	192	414
	100	202	447
34mm 1-11/32"	70	187	382
	85	199	427
	100	210	468
	115	220	505



MARINER

190-500 GPM
Single Speed Gear
Flanged Connection

Price

PERFORMANCE CHART - BIG RIVER			
Nozzle Size	PSI	Jet Length Ft.	GPM
20mm .78"	44	119	137
	56	132	159
	70	141	178
	85	150	194
22mm .86"	56	134	186
	66	141	197
	70	147	208
	85	157	228
24mm 15/16"	56	141	217
	66	147	230
	70	154	243
	85	164	266
26mm 1"	56	147	250
	70	157	280
	85	168	307
	100	173	330
28mm 1.10"	56	151	286
	70	160	319
	85	170	350
	100	177	378

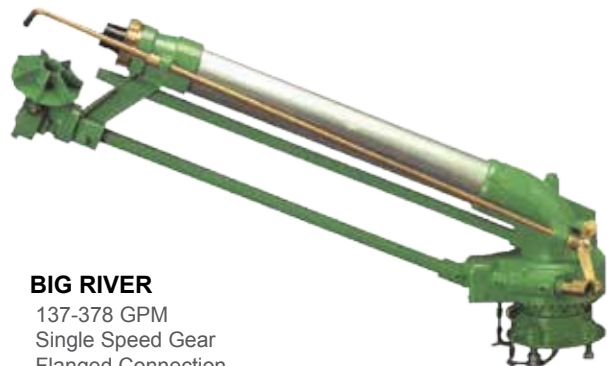

BIG RIVER

137-378 GPM
Single Speed Gear
Flanged Connection

Price

TURBINE DRIVE SPRINKLER GUNS

PERFORMANCE CHART - MERCURY			
Nozzle Size	PSI	Jet Length Ft.	GPM
14mm .55"	29	73	65
	44	82	79
	56	91	91
	70	100	102
16mm .63"	29	79	78
	44	85	96
	56	98	111
18mm .71"	70	107	124
	44	98	119
	56	107	139
20mm .78"	70	115	154
	85	125	170
	44	104	142
22mm .86"	56	114	165
	70	125	180
	85	138	203
	44	110	161
22mm .86"	56	119	186
	70	131	209
	85	140	228



MERCURY
65-228 GPM
Single Speed Gear
2" FNPT Connection

Price

PERFORMANCE CHART - SKIPPER			
Nozzle Size	PSI	Jet Length Ft.	GPM
12mm .47"	29	72	42
	44	82	51
	56	92	59
	70	101	66
14mm .55"	29	78	51
	44	88	66
	56	98	76
	70	108	85
16mm .63"	29	85	68
	44	95	83
	56	104	96
	70	114	107
18mm .71"	29	91	84
	44	101	106
	56	111	124
	70	121	137
20mm .78"	29	98	93
	44	108	129
	56	121	151
	70	134	163



SKIPPER
42-160 GPM
Will Operate Under Low Pressure
1-1/2" FNPT Connection

Price

PERFORMANCE CHART - LUXOR			
Nozzle Size	PSI	Jet Length Ft.	GPM
12mm .47"	22	62	34
	29	72	40
	44	78	48
	56	88	55
14mm .55"	29	75	52
	44	91	63
	56	101	73
	70	111	82
16mm .63"	29	78	65
	44	98	80
	56	111	93
	70	118	103
18mm .71"	29	78	82
	44	105	100
	56	115	115
	70	125	128
20mm .78"	29	82	99
	44	100	121
	56	122	140
	70	135	157



LUXOR
35-160 GPM
Will Operate Under Low Pressure
1-1/2" FNPT Connection

Price

TURBINE DRIVE SPRINKLER GUNS

PERFORMANCE CHART - RIVER			
Nozzle Size	PSI	Jet Length Ft.	GPM
10mm .40"	29	61	23
	37	66	26
	44	69	29
	56	76	33
12mm .47"	37	69	38
	44	73	41
	51	79	44
	56	86	48
14mm .55"	37	69	51
	44	76	56
	51	86	61
	66	92	69
16mm .63"	44	89	73
	51	92	79
	56	99	85
	70	109	94
18mm .71"	44	92	92
	56	102	107
	70	116	119
	85	122	131



RIVER
23-131 GPM
Will Operate Under Low Pressure
1-1/2" FNPT Connection

Price

IMPACT SPRINKLER GUNS

PERFORMANCE CHART - EXPLORER							
Nozzle Size	PSI	Jet Length Ft.	GPM	Nozzle Size	PSI	Jet Length Ft.	GPM
30mm 1-3/16"	56	157	257	36mm 1.42"	70	199	477
	70	170	297		85	217	523
	85	184	332		100	229	564
	100	196	364		115	242	603
32mm 1-1/4"	56	177	338	38mm 1.5"	70	206	532
	70	190	378		85	223	583
	85	202	414		100	236	628
	100	217	447		115	249	673
34mm 1-11/32"	70	192	427	40mm 1.57"	70	213	589
	85	210	468		85	226	646
	100	223	505		100	239	696
	115	236	538		115	255	745



EXPLORER
250-750 GPM
Good All Around Gun for High Volume Output
Flanged Connection

Price

PERFORMANCE CHART - REFLEX			
Nozzle Size	PSI	Jet Length Ft.	GPM
26mm 1.02"	44	137	193
	56	154	223
	70	170	250
	85	181	274
28mm 1.1"	44	145	224
	56	168	259
	70	184	289
	85	190	317
30mm 1.19"	44	150	257
	56	170	297
	70	187	332
	85	196	364
32mm 1.26"	56	173	338
	70	190	378
	85	202	414
	100	213	447
34mm 1.34"	56	177	382
	70	192	427
	85	210	468
	100	217	505



REFLEX
200-500 GPM
Flanged Connection

Price

IMPACT SPRINKLER GUNS

PERFORMANCE CHART - RANGER							
Nozzle Size	PSI	Jet Length Ft.	GPM	Nozzle Size	PSI	Jet Length Ft.	GPM
24mm 15/16"	29	108	134	30mm 1-3/16"	44	151	257
	44	127	164		56	164	297
	56	145	190		70	177	332
	70	157	213		85	187	364
26mm 1"	29	121	158	32mm 1-1/4"	56	170	338
	44	134	193		70	184	378
	56	150	223		85	192	414
	70	168	250		100	202	447
28mm 1.1"	44	145	224	34mm 1-11/32"	56	173	382
	56	157	259		70	187	427
	70	170	289		85	199	468
	85	181	317		100	210	505



RANGER
135-500 GPM
Good All Around Gun for High Volume Output
3" FNPT Connection

Price

PERFORMANCE CHART - SYNKRO			
Nozzle Size	PSI	Jet Length Ft.	GPM
14mm .55"	22	75	39.6
	29	82	46
	44	95	56.1
	56	105	64.8
16mm .63"	29	89	59.8
	44	105	73
	56	118	84.6
	70	128	94.2
18mm .71"	29	95	75.6
	44	108	92.6
	56	122	106
	70	135	119
20mm .78"	29	99	93.6
	44	115	114
	56	128	132
	70	141	148
22mm .86"	44	122	138
	56	135	159
	70	148	178
	85	158	196



SYNKRO
40-200 GPM
2-1/2" FNPT Connection

Price

PERFORMANCE CHART - ROYAL			
Nozzle Size	PSI	Jet Length Ft.	GPM
14mm .55"	22	75	40
	29	82	46
	44	95	56
	56	105	65
16mm .63"	29	89	60
	44	105	73
	56	118	85
	70	128	94
18mm .71"	29	95	76
	44	108	93
	56	122	106
	70	135	119
20mm .78"	29	99	94
	44	115	114
	56	128	132
	70	141	148
22mm .86"	44	122	138
	56	135	159
	70	148	178
	85	158	196

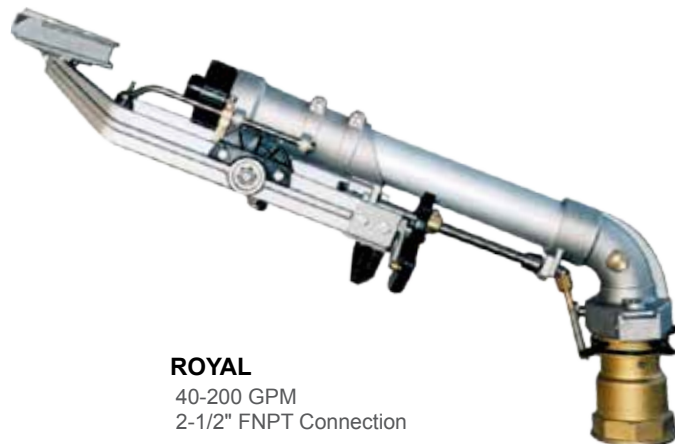

ROYAL
40-200 GPM
2-1/2" FNPT Connection

Price

INTRO
1. ELECTRICAL
2. PUMP Acc.
3. HOSE, PE PIPE & Acc.
4. IPS, PIP PIPE & Acc.
5. SURFACE
6. SPRINKLERS
7. TRAVELER & WHEEL MOVE
8. PIVOT
9. TURF
10. LOW VOLUME
11. FILTERS
12. INJECTION
13. HARDWARE
INDEX

IMPACT SPRINKLER GUNS

PERFORMANCE CHART - QUASAR

Nozzle Size	PSI	Jet Length Ft.	GPM
14mm .55"	22	75	40
	29	82	46
	44	95	56
	56	105	65
16mm .63"	29	89	60
	44	105	73
	56	118	85
	70	128	94
18mm .71"	29	95	76
	44	108	93
	56	122	106
	70	135	119
20mm .78"	29	99	94
	44	115	114
	56	128	132
	70	141	148
22mm .86"	44	122	138
	56	135	159
	70	148	178
	85	158	196

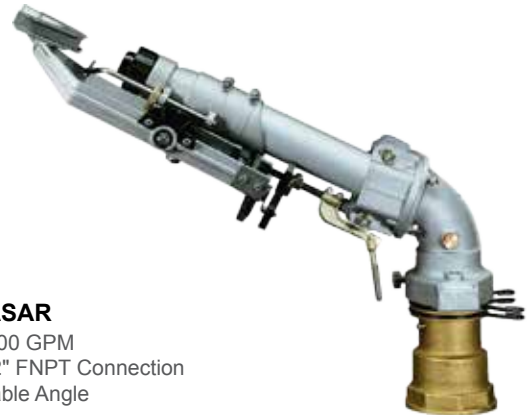

QUASAR
40-200 GPM
2-1/2" FNPT Connection
Variable Angle

Price

PERFORMANCE CHART - DUPLEX

Nozzle Size	PSI	Jet Length Ft.	GPM
8mm/.32" 12mm/.48"	22	65	42
	29	75	49
	44	89	59
	56	98	68
8mm/.32" 14mm/.55"	29	82	61
	44	95	74
	58	105	86
	73	112	96
8mm/.32" 16mm/.63"	29	89	75
	44	102	91
	58	112	105
	73	121	118
8mm/.32" 18mm/.71"	22	92	91
	44	108	115
	58	118	134
	73	131	148
8mm/.32" 20mm/.79"	22	95	109
	44	112	137
	58	125	160
	73	141	174



DUPLEX
40-174 GPM
Spreader Drive Operation
2" FNPT Connection

Price

PERFORMANCE CHART - SENIOR

Nozzle Size	PSI	Jet Length Ft.	GPM
12mm .47"	22	62	34.3
	29	72	40.2
	44	78	48.1
	56	88	55
14mm .55"	29	75	51.6
	44	91	63.2
	56	101	73.2
	70	111	81.7
16mm .63"	29	78	65.3
	44	98	80.1
	56	111	92.8
	70	118	103
18mm .71"	29	78	81.7
	44	105	100
	56	115	115
	70	125	128
20mm .78"	29	82	99.4
	44	100	121
	56	122	140
	70	135	157



SENIOR
34-157 GPM
2" FNPT Connection

Price

IMPACT SPRINKLER GUNS

PERFORMANCE CHART - HIDRA			
Nozzle Size	PSI	Jet Length Ft.	GPM
12mm/.47" 5mm/.19"	29	65	40
	44	78	48
	58	88	56
	73	98	62
14mm/.55" 5mm/.19"	29	69	52
	44	82	63
	58	95	73
	73	101	81
16mm/.63" 5mm/.19"	29	72	65
	44	85	80
	58	98	93
	73	108	103
18mm/.70" 5mm/.19"	44	92	100
	58	101	115
	73	112	128
	88	118	140



HIDRA
40-140 GPM
1-1/2" FNPT Connection

Price

PERFORMANCE CHART - AMBO			
Nozzle Size	PSI	Jet Length Ft.	GPM
6mm/.23" 8mm/.32"	22	52	20
	29	57	23
	44	64	28
	58	69	33
6mm/.23" 10mm/.39"	22	56	27
	29	59	31
	44	69	38
	58	75	44
6mm/.23" 12mm/.47"	22	59	36
	29	64	42
	44	72	51
	58	82	59
6mm/.23" 14mm/.55"	29	67	51
	37	71	60
	44	77	66
	58	85	76
6mm/.23" 16mm/.63"	29	69	67
	44	79	83
	58	87	96
	73	95	107



AMBO
20-107 GPM
Spreader Drive Operation
1-1/2" FNPT Connection

Price

PERFORMANCE CHART - K-1			
Nozzle Size	PSI	Jet Length Ft.	GPM
8mm .315"	22	51	13
	29	56	15
	44	62	18
	58	67	21
9mm .354"	22	54	16
	29	57	19
	44	64	23
	58	69	26
10mm .394"	22	56	20
	29	59	23
	44	67	28
	58	72	33
12mm .472"	22	56	29
	29	62	34
	44	68	41
	58	77	47



K-1
13-47 GPM
1-1/4" FNPT Connection

Price

IMPACT SPRINKLER GUNS

PERFORMANCE CHART - IBIS			
Nozzle Size	PSI	Jet Length Ft.	GPM
5mm/.20" 6mm/.24"	22	43	12.2
	29	50	14
	44	56	17
	58	59	20
5mm/.20" 8mm/.31"	22	48	18
	29	54	21
	44	59	25
5mm/.20" 10mm/.39"	58	62	30
	22	53	25
	29	56	29
	44	64	35
	58	69	41



IBIS
12-41 GPM
1" FNPT Connection

Price

PERFORMANCE CHART - FUNNY			
Nozzle Size	PSI	Jet Length Ft.	GPM
5mm .20"	22	42	5.3
	29	46	6
	44	50	7
	58	54	9
6mm .24"	22	43	7
	29	48	8.5
	44	54	10
7mm .28"	58	58	12
	22	46	10
	29	50	11
	44	56	14
9mm .35"	58	61	16
	22	50	16.4
	29	54	19
44	61	23	
	58	64	26



FUNNY
6-26 GPM
1" FNPT

Price

PERFORMANCE CHART - SILVER			
Nozzle Size	PSI	Jet Length Ft.	GPM
4mm .16"	22	36	3
	29	40	4
	44	43	4.5
	58	50	5
5mm .20"	22	40	5.3
	29	43	6
	44	46	7
6mm .24"	58	53	8.5
	22	43	7
	29	46	9
	44	50	10
	58	54	12



SILVER
3-12 GPM
3/4" MNPT/1" FNPT

Price

PERFORMANCE CHART - JUNIOR			
Nozzle Size	PSI	Jet Length Ft.	GPM
4mm .22"	22	33	2
	29	36	3
	37	40	3
	44	41	3.5



JUNIOR
2-4 GPM
1/2" MNPT

Price

GUN ADAPTERS



FLANGE ADAPTER FOR SIME FLANGED GUNS

Part No.	Description	Price
60200180Z	Flange Adapter	
60001105	Nelson Companion Flange	
JUPITER021	Companion Flange Gasket	
	Nut & Bolt Set for Sime Flange	
	Nut & Bolt Set for Companion Flange	



QUICK DISCONNECT "GUN" ADAPTERS

New Part No.	Part No.	Description	Price
5217511-0003	2247-3 FEMALE	Gun Adapter, 3" Female Only, Weld-On	
5217511-1502	2247-3F2F	Gun Adapter, 3" Female x 2" FIPT	
5217511-1503	2247-3F25F	Gun Adapter, 3" Female x 2.5" FIPT	
5217511-1002	2247-3F2M	Gun Adapter, 3" Female x 2" MIPT	
5217511-1003	2247-3F25M	Gun Adapter, 3" Female x 2.5" MIPT	
5217511-1504	2247-3F3F	Gun Adapter, 3" Female x 3" FIPT	
5217511-1004	2247-3F3M	Gun Adapter, 3" Female x 3" MIPT	
5217511-0004	2247-4 FEMALE	Gun Adapter, 4" Female Only, Weld-On	
5217511-3504	2247-4F4F	Gun Adapter, 4" Female x 4" FIPT	
5217511-3004	2247-4F4M	Gun Adapter, 4" Female x 4" MIPT	
5217501-0503	2247-3MALE	Gun Adapter, 3" Male Only, Weld-On	
5217501-2002	2247-3M2M	Gun Adapter, 3" Male x 2" MIPT	
5217501-2003	2247-3M25M	Gun Adapter, 3" Male x 2.5" MIPT	
5217501-2502	2247-3M2F	Gun Adapter, 3" Male x 2" FIPT	
5217501-2004	2247-3M3M	Gun Adapter, 3" Male x 3" MIPT	
5217501-2504	2247-3M3F	Gun Adapter, 3" Male x 3" FIPT	
5217501-4002	2247-4M3M	Gun Adapter, 4" Male x 3" MIPT	
5217501-4004	2247-4M4M	Gun Adapter, 4" Male x 4" MIPT	
5217601-0003	2248-3	Gun Adapter, 3" Plug	
5217601-0004	2248-4	Gun Adapter, 4" Plug	
3011301-0004	3070-4	Gun Adapter, 4" Ring Lock Band - for 3"	
3011301-0005	3070-5	Gun Adapter, 5" Ring Lock Band - for 4"	
9090110-0003	2305-3	Gun Adapter, 3" Gasket	
9090110-0004	2305-4	Gun Adapter, 4" Gasket	
9090110-9003	1080-3	Gun Adapter, 3" Gasket (Old Style Narrow)	
9090110-9004	1080-4	Gun Adapter, 4" Gasket (Old Style Narrow)	

INTRO | 1. ELECTRICAL | 2. PUMP ACC. | 3. HOSE, PE PIPE & ACC. | 4. IPS, PIP PIPE & ACC. | 5. SURFACE | 6. SPRINKLERS | 7. TRAVELER & WHEEL MOVE | 8. PIVOT | 9. TURF | 10. LOW VOLUME | 11. FILTERS | 12. INJECTION | 13. HARDWARE | INDEX

ALUMINUM GUN STAND

This tripod style gun stand is made from aluminum, making it lighter weight and more easily transportable than steel gun stands of the same design. It is constructed with 3/4" support legs and a 3" aluminum riser. Standard height is 48". It can be ordered with either a 3" or 4" Band and Latch inlet. Other heights and connections are available upon special order.

Part No.	Description	Price
17-3	3" Inlet x 3" & 4" Mainline Clamp x 2" FIPT & 2-1/2" MIPT Top Conn.	
17-4	4" Inlet x 3" & 4" Mainline Clamp x 2" FIPT & 2-1/2" MIPT Top Conn.	



GALVANIZED RUBBER TIRE SPRINKLER GUN CART

Part No.	Description	Price
GGC-32	3" Body x 2" MIPT Inlet x 2" MIPT Outlet	
GGC-43	4" Body x 3" MIPT Inlet x 3" MIPT Outlet	
GGC-44	4" Body x 4" MIPT Inlet x 4" MIPT Outlet	

Sprinkler Not Included

GALVANIZED GUN CART

This heavy-duty cart is supplied with a 3" or 4" Band and Latch inlet and a 2" FIPT x 2-1/2" MIPT or 3" FIPT outlet. An 84" long, 4" diameter, 6' axle with 46" wheels. The weight of this cart is 150 lbs. and has a corrosion resistant galvanized coating. Other options are available upon request. This price does not include a sprinkler.

Part No.	Description	Price
5046-3	Two Wheel Gun Cart 3" B & L Inlet X 2" FIPT / 2-1/2" MIPT Outlet	
5046-4	Two Wheel Gun Cart 4" B & L Inlet X 2" FIPT / 2-1/2" MIPT Outlet	



1000F WHEELED SPRINKLER CART

Part No.	Description	Price
1000F	1" Cart w/ Funny Sprinkler	

1000F SPRINKLER CART PERFORMANCE

Nozzle Size	PSI	GPM	Jet Length/ Ft. (One Direction)	Wetted Circle (Diameter/Ft)
5mm (.20")	22	5.3	42	84
	29	6	46	92
	44	7	50	100
	58	9	54	108
6mm (.24")	22	7	43	86
	29	8.5	48	96
	44	10	54	108
	58	12	58	116
7mm (.28")	22	10	46	92
	29	11	50	100
	44	14	56	112
	58	16	61	122
9mm (.35")	22	16.4	50	100
	29	19	54	108
	44	23	61	122
	58	26	64	128

Specifications:

- Flow Rate: 6 - 26 GPM
- Pressure: 20 - 80 PSI
- Sprinkler Trajectory: 28°
- Sprinkler Stand Body Size: 1" Heavy Gauge Tubing
- Inlet Size: ¾" Standard (Included), Adaptable to 1"
- Overall Height (w/ sprinkler): 22"
- Overall Length: 28"
- Overall Width: 25"
- Total Weight: 20 lbs.
- Nozzle Sizes Included: 5 mm, 6 mm, 7 mm, 8 mm, & 9 mm

Features & Benefits:

- Heavy Gauge Steel Tube Construction
- Solid 1.5" Steel Axle
- Brass Garden Hose Swivel Adapter
- Solid 8" Rubber Wheel Assembly
- Durable "Baked On" Powder Coat Finish
- Commercial Grade Full or Part Circle Impact Sprinkler w/ Brass Base

Applications:

- Garden Irrigation
- Residential or Acreage Yard Irrigation
- Horse Arena Dust Control
- School Playground Irrigation
- Natural Sports Turf Irrigation
- Artificial Sports Turf Irrigation & Cooling
- Mining Dust Control
- Pasture Irrigation
- Hobby Farm Irrigation



Wetted Patterns Up to 100'

1250K WHEELED SPRINKLER CART

Part No.	Description	Price
1250k	1-1/4" Cart w/ Funny Sprinkler	

1250K SPRINKLER CART PERFORMANCE

Nozzle Size	PSI	GPM	Jet Length/ Ft. (One Direction)	Wetted Circle (Diameter/Ft)
7mm (.28")	22	10	46	92
	29	11	50	100
	44	14	56	112
	58	16	61	122
8mm (.315")	22	13	51	102
	29	15	56	112
	44	18	62	124
	58	21	67	134
9mm (.354")	22	16	54	108
	29	19	57	114
	44	23	64	128
	58	26	69	138
10mm (.394")	22	20	56	112
	29	23	59	118
	44	28	67	134
	58	33	72	144
12mm (.472")	22	29	56	112
	29	34	62	124
	44	41	68	136
	58	47	77	154

Specifications:

- Flow Rate: 10 - 47 GPM
- Pressure: 20 - 80 PSI
- Sprinkler Trajectory: 30°
- Sprinkler Stand Body Size: 1-1/4" Heavy Gauge Tubing
- Inlet Size: 1-1/4" Standard (Included), Adaptable to 1" or 2"
- Overall Height (w/ sprinkler): 33"
- Overall Length: 34"
- Overall Width: 38"
- Total Weight: 40 lbs.
- Nozzle Sizes Included: 7 mm, 8 mm, 9 mm, & 10 mm

Features & Benefits:

- Heavy Gauge Steel Tube Construction
- Solid 1.5" Steel Axle
- Solid 10" Plastic Hub/Rubber Tread Wheel Assembly
- Durable "Baked On" Powder Coat Finish
- Commercial Grade Full or Part Circle Impact Sprinkler w/ Brass Base
- Full Range of Nozzles Included

Applications:

- General Irrigation Use
- Gardens
- Residences or Acreages
- Horse Arena Dust Control
- School Playgrounds
- Natural Sports Turf
- Artificial Sports Turf Cooling
- Mining Dust Control
- Pastures
- Hobby Farms
- Wildlife Food Plot



Wetted Patterns Up to 150'

Notice: These specifications are to be used as a guide only and have been calculated at zero wind conditions. Performances can vary due to pressure, terrain, and field conditions. Caution: Pressures exceeding those listed in the chart above may cause cart to become unstable and possibly overturn. It is recommended to operate the sprinkler only on a flat terrain, and within the parameters listed.

INTRO | 1. ELECTRICAL | 2. PUMP ACC. | 3. HOSE, PE PIPE & ACC. | 4. IPS, PIP PIPE & ACC. | 5. SURFACE | 6. SPRINKLERS | 7. TRAVELER & WHEEL MOVE | 8. PIVOT | 9. TURF | 10. LOW VOLUME | 11. FILTERS | 12. INJECTION | 13. HARDWARE | INDEX

1250H WHEELED SPRINKLER CART

Part No.	Description	Price
1250H	1-1/4" Cart w/ Hidra Sprinkler	

1250H SPRINKLER CART PERFORMANCE

Nozzle Size	PSI	GPM	Jet Length/ Ft. (One Direction)	Wetted Circle (Diameter/Ft)
12mm (.47") w/5mm (.019") Diffuser Nozzle	29	40	65	130
	44	48	78	156
	58	56	88	176
	73	62	98	196
14mm (.55") w/5mm (.019") Diffuser Nozzle	29	52	69	138
	44	63	82	164
	58	73	95	190
	73	81	101	202
16mm (.63") w/5mm (.019") Diffuser Nozzle	29	65	72	144
	44	80	85	170
	58	93	98	196
	73	103	108	216
18mm (.70") w/5mm (.019") Diffuser Nozzle	44	100	92	184
	58	115	101	202
	73	128	112	224

Specifications:

- Flow Rate: 30 - 140 GPM
- Pressure: 20 - 100 PSI
- Sprinkler Trajectory: 25°
- Sprinkler Stand Body Size: 1-1/4" Heavy Gauge Tubing
- Inlet Size: 1-1/4" Standard (Included), Adaptable to 1" or 2"
- Overall Height (w/ sprinkler): 33"
- Overall Length: 34"
- Overall Width: 38"
- Total Weight: 48 lbs.
- Nozzle Sizes Included: 12 mm, 14 mm, & 16 mm

Features & Benefits:

- Heavy Gauge Steel Tube Construction
- Solid 1.5" Steel Axle
- Solid 10" Steel Hub/Solid Rubber Filled Tread Wheel Assembly
- Durable "Baked On" Powder Coat Finish
- Commercial Grade Full or Part Circle Impact Sprinkler w/ Brass Base

Applications:

- General Irrigation Use
- Gardens
- Residences or Acreages
- Horse Arena Dust Control
- School Playgrounds
- Natural Sports Turf
- Artificial Sports Turf Cooling
- Mining Dust Control
- Pastures
- Hobby Farms
- Wildlife Food Plot



Wetted Patterns Up to 200'

2000S WHEELED SPRINKLER CART

Part No.	Description	Price
2000S	2" Cart w/ Senior Sprinkler	

2000S SPRINKLER CART PERFORMANCE

Nozzle Size	PSI	GPM	Jet Length/ Ft. (One Direction)	Wetted Circle (Diameter/Ft)
12mm (.47")	22	34.3	62	124
	29	40.2	72	144
	44	48.1	78	156
	56	55	88	176
14mm (.55")	29	51.5	75	150
	44	63.2	91	182
	56	73.2	101	202
	70	81.7	111	222
16mm (.63")	29	65.3	78	156
	44	80.1	98	196
	56	92.8	111	222
	70	103	118	236
18mm (.71")	29	91.7	78	156
	44	100	105	210
	56	115	115	230
	70	128	125	250
20mm (.78")	29	99.4	82	164
	44	121	100	200
	56	140	122	244
	70	157	135	270

Specifications:

- Flow Rate: 40 - 200 GPM
- Pressure: 30 - 100 PSI
- Sprinkler Trajectory: 25°
- Sprinkler Stand Body Size: 2" Heavy Gauge Tubing
- Inlet Size: 2" Standard, Adaptable to 1.5" or 2.5"
- Overall Height (w/ sprinkler): 41"
- Overall Length: 60"
- Overall Width: 60"
- Total Weight: 200 lbs.

Features & Benefits:

- Heavy Gauge Steel Tube Construction
- 3" Heavy Gauge Steel Square Tube Axle
- 15" x 6.00 x 6" Steel Rim/Pneumatic Wheel Assembly
- ATV Hitch Standard w/ Lift Handle
- Durable "Baked On" Powder Coat Finish
- Commercial Grade Full or Part Circle Impact Sprinkler w/ Brass Base
- Full Range of Nozzle Sizes Included

Applications:

- General Irrigation Use
- Natural Sports Field Irrigation
- Artificial Sports Field Irrigation
- General Agriculture Irrigation
- Mining Dust Control
- Pasture Irrigation
- Hobby Farm Irrigation
- Wildlife Food Plot Irrigation
- Reclamation Sprinkler Irrigation
- Large Horse Arena Dust Suppression
- Golf Course Fairway Irrigation



Wetted Patterns Up to 250'

Notice: These specifications are to be used as a guide only and have been calculated at zero wind conditions. Performances can vary due to pressure, terrain, and field conditions. Caution: Pressures exceeding those listed in the chart above may cause cart to become unstable and possibly overturn. It is recommended to operate the sprinkler only on a flat terrain, and within the parameters listed.

3000R WHEELED SPRINKLER CART

Part No.	Description	Price
3000R	3" Cart w/ Ranger Sprinkler	

3000R SPRINKLER CART PERFORMANCE

Nozzle Size	PSI	GPM	Jet Length/ Ft. (One Direction)	Wetted Circle (Diameter/Ft)
24mm (.938")	29	134	108	216
	44	164	127	254
	56	190	145	290
	70	213	157	314
26mm (1.0")	29	158	121	242
	44	193	134	268
	56	220	150	300
28mm (1.1")	44	224	145	290
	56	259	157	314
	70	289	170	340
	85	317	181	362
30mm (1.188")	44	257	151	302
	56	297	164	328
	70	332	177	354
32mm (1.25")	85	364	187	374
	56	338	170	340
	70	378	184	368
34mm (1.344")	85	414	192	384
	100	447	202	404
	56	382	173	346
34mm (1.344")	70	427	187	374
	85	468	199	398
	100	505	210	420

Specifications:

- Flow Rate: 125 - 500 GPM
- Pressure: 30 - 100 PSI
- Sprinkler Trajectory: 25°
- Sprinkler Stand Body Size: 3"
- Heavy Schedule 40" Gauge Steel Tubing
- Inlet Size: 3" Standard, Adaptable to 2", 2.5", or 4"
- Overall Height (with sprinkler): 54"
- Overall Length: 70"
- Overall Width: 62"
- Total Weight: 420 lbs

Features & Benefits:

- Heavy Gauge Steel 3" Pipe Construction
- 3" Heavy Gauge Steel Square Tube Axle
- Drop Down Stabilizer Feet
- 20.5 x 8.00 x 10 Steel Rim/Pneumatic Wheel Assembly
- Pin Hitch for Tractor/ATV Standard w/ Lift Handle
- Durable "Baked On" Powder Coat Finish
- Commercial Grade Full or Part Circle Impact Sprinkler w/ Full Range of Nozzles Included

Applications:

- General Agriculture Irrigation
- Mining Dust Control
- Pastures
- Hobby Farms
- Wildlife Food Plots
- Reclamation Sprinkler Irrigation & Golf Course Fairway Irrigation

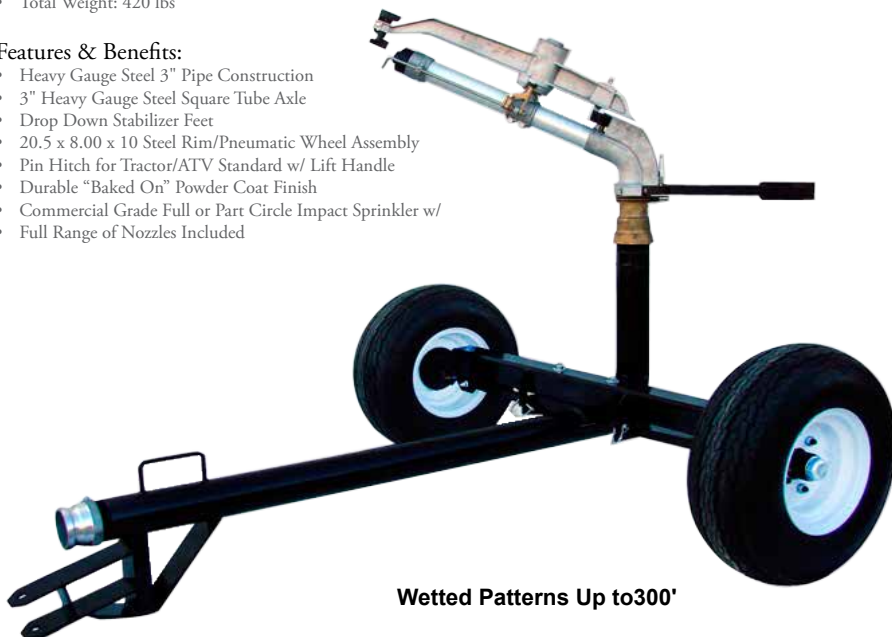

Notice: These specifications are to be used as a guide only and have been calculated at zero wind conditions. Performances can vary due to pressure, terrain, and field conditions. Caution: Pressures exceeding those listed in the chart above may cause cart to become unstable and possibly overturn. It is recommended to operate the sprinkler only on a flat terrain, and within the parameters listed.

INTRO
1. ELECTRICAL
2. PUMP, ACC.
3. HOSE, PE PIPE & ACC.
4. IPS, PIP PIPE & ACC.
5. SURFACE
6. SPRINKLERS
7. TRAVELER & WHEEL MOVE
8. PIVOT
9. TURF
10. LOW VOLUME
11. FILTERS
12. INJECTION
13. HARDWARE
INDEX

SECTION 7

Traveler & Wheel Move

CONTENTS

7:4-6	IRRIPOD
7:4	IRRIPOD RANCH PACK
7:5	IRRIPOD COMPONENTS
7:6	IRRIPOD COMPONENTS
7:7-12	AG - MICRO RAIN TRAVELERS
7:7	MICRO RAIN TRAVELERS
7:8	MICRO RAIN TRAVELERS - SMALL-LINE
7:9	MICRO RAIN TRAVELERS - MID-LINE
7:9	MICRO RAIN TRAVELERS - LARGE-LINE
7:10	MICRO RAIN TRAVELERS - LARGE-LINE
7:11	MICRO RAIN TRAVELERS - LARGE-LINE
7:11	MICRO RAIN TRAVELERS - ENGINE DRIVE - MID-LINE & LARGE-LINE
7:12	MICRO RAIN TRAVELERS - PERFORMANCE SUMMARY
7:13-16	WATER SUPPLY PUMPS
7:17-27	WHEEL MOVE
7:17	WHEEL MOVE SYSTEMS
7:17	WHEEL MOVE HYDRAULIC MOVERS
7:17-25	WHEEL MOVE FITTINGS & PARTS
7:26	SINGLE RAIL MOVER ASSEMBLY
7:27	TWIN RAIL MOVER ASSEMBLY

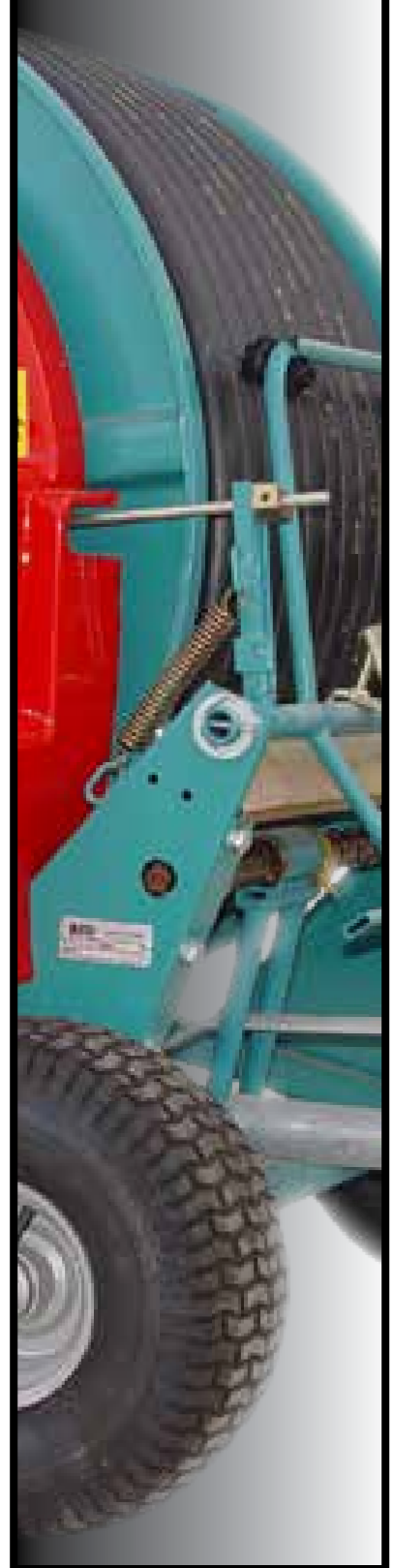

Irripod Plus is a flexible, cost effective pipeline sprinkler irrigation system for pasture and forage crops.

Designed to operate at low pressure Irripod Plus distributes water on a slow absorption rate over a 12-24-hour period. This allows for effective absorption into the soil while eliminating pooling and run off. The system only requires movement once per 12-24 hour period.

Irripod Plus is a component system that is simple to install and manage. The system utilizes protective Pod Skid covers over sprinklers that are attached to an irrigation pipeline. Irripod Plus can be configured to suit individual requirements dependent on application rates, the distance to be irrigated and the rotation intervals appropriate for the situation. Each Irripod irrigation line can be customized to suit varying paddock sizes and shapes while also accommodating existing obstructions.

Irripod irrigation lines are strong, lightweight and flexible, easily moved while the system is operating by attaching the lines to an ATV or farm vehicle.

The flexibility of Irripod Plus means the system can be configured for many different end uses in addition to traditional pasture and forage crop irrigation; these include orchards, golf courses, sports fields, race tracks, dust suppression in developing housing sub-divisions and bush fire protection.

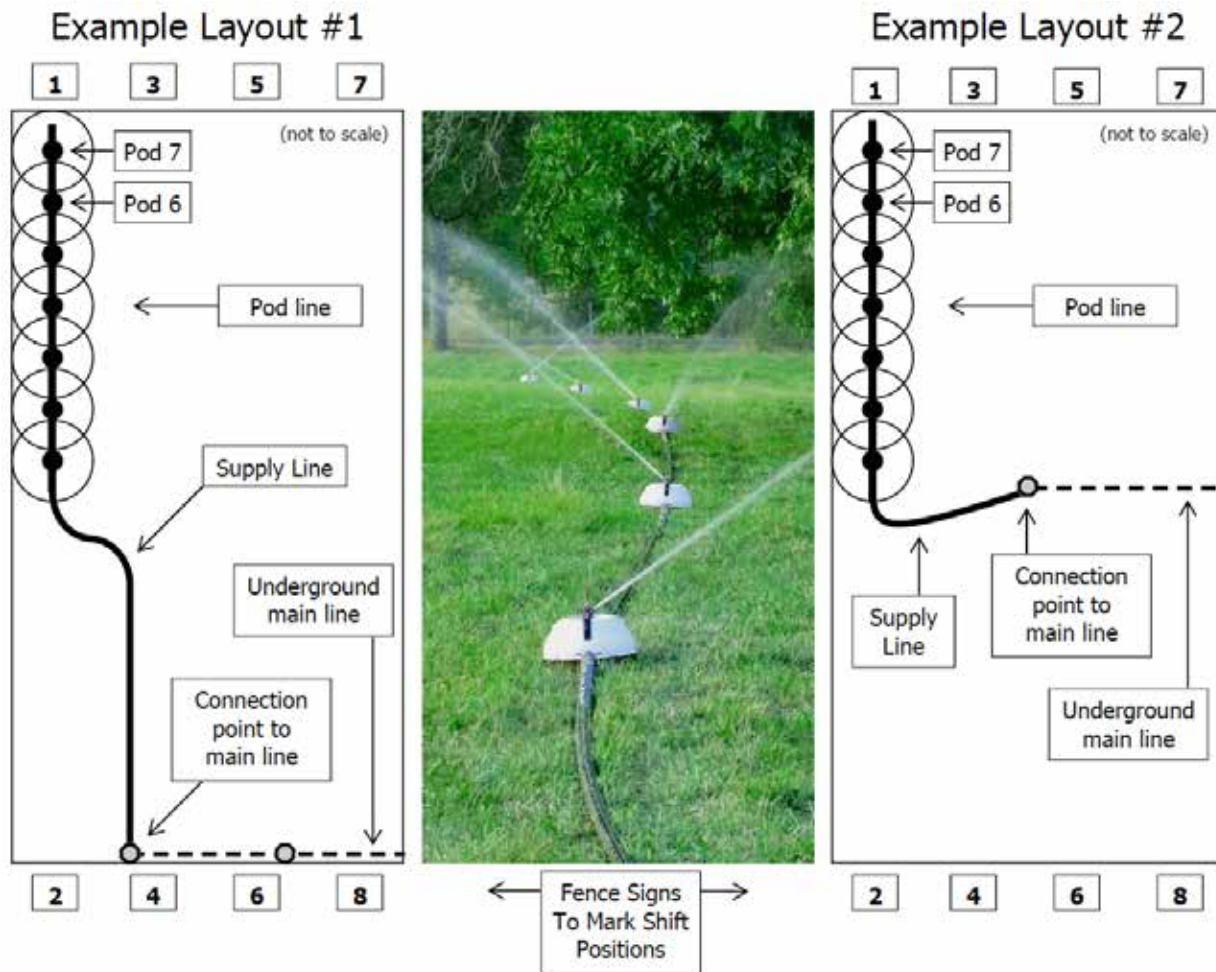

IRRIPOD RANCH PACK

Irripod Ranch Pack 5 - 5 Pod 2 Acre Kit

The 5 pod Ranch Pack is ideal for about 2 acres of pasture. (200' x 400' maximum)

Included is 300' of 1.5" Irripod tube, 5 pods, 5 saddles, 5 sprinklers with 3 sets of nozzles, and all the fittings required. All that is needed is a 1.5" MPT water supply connection at the center of the area to be irrigated.

IRRIPOD RANCH PACK 5 - 5 POD 2 ACRE KIT

Description	Price
5 - 7/64" nozzle=11.25GPM at 45 PSI	
5 - 1/8" nozzle=15GPM at 45 PSI	
5 - 9/64" nozzle= 18.75GPM at 45 PSI	

*Note that performance will vary depending on length of tubing, elevation changes, and other factors.



IRRIPOD COMPONENTS

IRRIPOD TUBE POLYETHYLENE BLEND FOR IRRIPOD

Part No.	Description	Price
IP-1.5-300	1.5" I.D. Poly Tube x 300' Coil (83 Lbs)	
IP-1.75-300	1.75" I.D. Poly Tube x 300' Coil (95 Lbs)	



IRRIPOD PODS

Part No.	Description	Price
IP-1.75-POD	POD for 1.5" & 1.75" Irripod Tube (7 box)	



TAPPING SADDLE TOPS

Part No.	Description	Price
IP-TST-1.5-A	1.5" Saddle x Acme Thread	
IP-TST-1.5-1/2	1.5" Saddle x 1/2" FPT High Riser	
IP-TST-1.5-3/4	1.5" Saddle x 3/4" MPT comes with 1 (3/4" FPT Coupler)	
IP-TST-1.75-LOW	1.75" Saddle x 1/2" FPT Low Riser	
IP-TST-1.75-1/2	1.75" Saddle x 1/2" FPT High Riser	
IP-TST-1.75-3/4	1.75" Saddle x 3/4" MPT comes with 1 (3/4" FPT Coupler)	



TOW HOOKS

Part No.	Description	Price
IP-1.5-THR	1.5" Irripod Barb x Tow Hook + Rope (includes 6' of rope)	
IP-1.75-THR	1.75" Irripod Barb x Tow Hook + Rope (includes 6' of rope)	
IP-2.0-THR	2.0" MPT x Tow Hook + Rope (includes 6' of rope) Ideal for use with Cam Lock Setups	



COUPLERS & REDUCING COUPLERS

Part No.	Description	Price
IP-1.5-C	1.5" Irripod Barb x 1.5" Irripod Barb	
IP-1.75-C	1.75" Irripod Barb x 1.75" Irripod Barb	
IP-1.75-RC-1.5	1.75" Irripod Barb x 1.5" Irripod Barb	



THREADED ADAPTERS

Part No.	Description	Price
IP-1.5-FA	1.5" Irripod Barb x 1.5" FPT	
IP-1.75-MA	1.75" Irripod Barb x 2.0" MPT	



CAM LOCK FITTINGS

Part No.	Description	Price
IP-CLE-1.5	1.5" Cam Lock Male x 1.5" Irripod Barb	
IP-CLE-1.75	2.0" Cam Lock Male x 1.75" Irripod Barb	



INTRO
 1. ELECTRICAL
 2. PUMP ACC.
 3. HOSE, PE PIPE & ACC.
 4. IPS, PIP PIPE & ACC.
 5. SURFACE
 6. SPRINKLERS
 7. TRAVELER & WHEEL MOVE
 8. PIVOT
 9. TURN
 10. LOW VOLUME
 11. FILTERS
 12. INJECTION
 13. HARDWARE
 INDEX

IRRIPOD COMPONENTS

NELSON LOW PRESSURE WIND FIGHTER ROTATORS (1/2" FEMALE ACME THREAD INLET)

Part No.	Description	Price
IP-R2000LP-1212	#12 Purple Plate and #12 Purple Nozzle	
IP-R2000LP-1414	#14 Green Plate and #14 Green Nozzle	
IP-R2000LP-1616	#16 Red Plate and #16 Red Nozzle	
IP-R2000LP-1818	#18 Gold Plate and #18 Gold Nozzle	
IP-R2000LP-2020	#20 Brown Plate and #20 Brown Nozzle	

Designed to operate between 25-50 PSI.
Other Nozzle and plate options available.



NELSON R33 3/4" ROTATORS (3/4" MPT INLET INLET)

Part No.	Description	Price
IP-R33-9/64	3/4" Rotator, Gold Plate, Gold Nozzle	
IP-R33-5/32	3/4" Rotator, Brown Plate, Brown Nozzle	
IP-R33-11/64	3/4" Rotator, Gold Plate, Grey Nozzle	
IP-R33-3/16	3/4" Rotator, Gold Plate, Green Nozzle	

Designed to operate between 40-65 PSI.
Other Nozzle and plate options available.



JAIN 5022 FULL CIRCLE PLASTIC IMPACTS

Part No.	Model	Description	Price
16052701	21152701	1/2" Male Single 3/32" Purple Nozzle	
16052702	21152702	1/2" Male Single 7/64" Orange Nozzle	
16052703	21152703	1/2" Male Single 15/128" Red Nozzle	
16052704	21152704	1/2" Male Single 1/8" Green Nozzle	
16052705	21152705	1/2" Male Single 9/64" Blue Nozzle	
16052706	21152706	1/2" Male Single 5/32" Black Nozzle	



SENNINGER 1/2" PLASTIC IMPACTS (1/2" MPT INLET)

Part No.	Description	Price
IP-S2023-7/64	1/2" MPT, 23°, with 7/64" Nozzle	
IP-S2023-1/8	1/2" MPT, 23°, with 1/8" Nozzle	
IP-S2023-9/64	1/2" MPT, 23°, with 9/64" Nozzle	

Designed to operate between 25-50 PSI.
Other Nozzles available.



SENNINGER 3/4" PLASTIC IMPACTS (3/4" MPT INLET)

Part No.	Description	Price
IP-S3023-1/8	3/4" MPT, 23°, with 1/8" Nozzle	
IP-S3023-9/64	3/4" MPT, 23°, with 9/64" Nozzle	
IP-S3023-5/32	3/4" MPT, 23°, with 5/32" Nozzle	

Designed to operate between 30-60 PSI.
Other Nozzles available.



MICRO RAIN TRAVELERS

Micro Rain Travelers have years of proven field service and simply do the job! Constructed with a durable all-metal chassis and drum design, these machines are built to stand up to years of use. At the heart of the Micro Rain is the rugged and reliable turbine drive system. Smooth and efficient power is developed as the water flows past the fins of the turbine impeller, powering our direct mounted gearbox system to drive the reel. All water entering the turbine remains in the system and passes through the sprinkler head, eliminating any need for water to be wasted or dumped around the machine, unlike other drive systems.

Micro Rain incorporates only the most advanced engineering and manufacturing techniques to build the Micro Rain traveler. The use of the highest quality components, robotic welding and hand selected suppliers for additional materials, ensures that it is the best built sprinkler of its type in the market place.

The Micro Rain can be supplied by a wide variety of water sources, such as wells, lakes, rivers, municipal water or gray water from lagoons. The Micro Rain's turbine drive system has earned the reputation of being very forgiving when faced with water issues such as high mineral content, grit and sand.

Your customer can load the Micro Rain in their truck or on a trailer and have it to their desired location and watering in a matter of hours. Just plug the supply hose into the water source, pull out the hose, turn the water on and adjust the speed. After it has completed its run, it turns off automatically and patiently waits for the next move. If existing pressure is insufficient, we can easily include a gasoline or electric powered booster pump to provide the desired water pressure needed.

Most systems are in stock and available for immediate supply. All systems include a part circle impact or rotor style sprinkler, supply hose, and manufacturers warranty on parts for 1 year from time of purchase and manufacturers warranty on poly tubing for 3 years from time of purchase. Whatever the application for watering; sports fields, parks, golf courses, driving ranges, riding arenas, dust control, acreages, vegetable plots, food plots for hunting (camouflage travelers available), residences, etc., there is a Micro Rain to fit your needs. Micro Rain travelers are the answer for an efficient, time saving and cost effective way to water.

BPP = PULL START BOOST PUMP
SPP = SELF-PRIMING SUPPLY PUMP;
HS = HIGH SPEED
HC = HIGH CART
SF = SUPER CAMO PATTERN
GG = GAME GUARD
BC = BRUSH COUNTRY

**ALL BOOST PUMP AND SUPPLY PUMPS POW-
 ERED BY HONDA GX SERIES ENGINES.**



MICRO RAIN TRAVELERS - SMALL-LINE

MR25

Compact and effective reel sprinkler! The MR25 connects to a standard 3/4 inch garden hose to operate totally unattended, with flows ranging from 3 to 10 gallons per minute. The sheer ease of setup and operation makes the MR25 very popular with homeowners for watering large lawns and gardens. Horse owners with small arenas and dressage rings rave about this model's ability to control dust and provide safe, uniform footing. View the performance chart to get a glimpse of the area covered by this model!

Standard Features:

- Turbine Operated
- Heavy Duty, All Metal Drum & Chassis Design
- Automatic Retraction & Shutdown
- Speed Control for Desired Application Rates
- Pressure Gauge to Determine Inlet Pressure
- Supply Hose (3/4" x 15')
- Two Wheel Sprinkler Cart w/ Part Circle Impact or Rotor Style Sprinkler
- Stabilizer Legs
- Durable Powder Coat Finish
- 1 Year Machine Warranty & 3 Year 100% Poly Tube Warranty



MR25

Part No.	Tube Inside Dia.	Tube Length	GPM	Sprinkler	Price
MR25	0.80"	165'	3-10	Rainbird 35	
MR25HS*	0.80"	165'	3-10	Rainbird 35	

* High Speed

MR32

The MR32 combines heavy duty, quality steel frame and reel construction with the simple, yet maneuverable two wheel design like it's smaller counterpart the MR25. Built to withstand heavy use, the MR32 operates from a 1 inch line (or 3/4" hose if flow and pressure is adequate) and allows irrigated areas up to 300 feet long and 120 feet wide for sports fields, horse arenas, hobby farms, or any area up to 4 acres. The MR32 is also available with a hitch kit making it compatible for towing with an ATV or small garden tractor! An excellent reel irrigator for many different applications! View the full performance chart for coverages and application rates.

Standard Features:

- Turbine Operated
- Heavy Duty, All Metal Drum & Chassis Design
- Automatic Retraction & Shutdown
- Speed Control for Desired Application Rates
- Pressure Gauge to Determine Inlet Pressure
- Supply Hose (3/4" x 15')
- Two Wheel Sprinkler Cart w/ Part Circle Impact or Rotor Style Sprinkler
- Stabilizer Legs
- Durable Powder Coat Finish
- 1 Year Machine Warranty & 3 Year 100% Poly Tube Warranty



MR32

Part No.	Tube Inside Diameter	Tube Length	GPM	Sprinkler	Price
MR32	1.0"	242'	3-30	Funny / K1	
MR32HS*	1.0"	242'	3-30	Funny / K1	

* High Speed

MR32 Ultra Drive

The MR32 Ultra Drive utilizes dry cell battery technology that powers a small 12-volt motor to retract the hose. Simply charge the battery, move the unit to any operating location and begin watering for up to eight hours of continuous operation. This system does not require any water flow or pressure to retract the hose, meaning any water source from 3 to 30 gallons per minute is adequate. Low pressure is not a problem with the Ultra Drive!

Standard Features:

- 12 Volt Electric Drive
- Odyssey Dry Cell Battery
- 3 Amp, Battery Charger w/ Auto Shut-Off
- Heavy Duty, All Metal Drum & Chassis Design
- Automatic Retraction & Shutdown
- Speed Control for Desired Application Rates
- Pressure Gauge to Determine Inlet Pressure
- Supply Hose (1" x 15')
- Scrolled Levelwind to Ensure Tube Wraps Correctly
- Tube Mis-Wrap Safety
- Two Wheel Sprinkler Cart w/ Part Circle Impact or Rotor Style Sprinkler
- Stabilizer Legs
- Durable Powder Coat Finish
- 1 Year Machine Warranty & 3 Year, 100% Poly Tube Warranty



MR32 ULTRA DRIVE

Part No.	Tube Inside Diameter	Tube Length	GPM	Sprinkler	Price
MR32 Ultra Drive	1.0"	242'	3-30	Rainbird 35 / Funny / K1	

MICRO RAIN TRAVELERS - MID-LINE

MR43

The MR43 is one of our most popular machines and meets a variety of irrigation needs including single pass coverage on football fields, large riding arenas, small acreage irrigation, and much more! Built with a three wheel chassis design and integrated stabilizer hitch, the MR43 has a flow range from 15 to 60 gallons per minute and 393 feet of hose length. The MR43 can effectively water up to 1.5 acres in a single pull! The ability to add the reliable on board Honda boost pump kit with auxilliary large capacity fuel tank for longer run times, can greatly enhance performance in low-pressure situations.

Standard Features:

- Three Wheel Chassis Design for Easy Towing
- Turbine Operated
- Automatic Retraction & Shutdown
- Speed Control for Desired Application Rates
- Pressure Gauge to Determine Inlet Pressure
- Supply Hose (2" x 20')
- Scrolled Level-Wind to Facilitate Correct Tube Wrapping
- Tube Mis-Wrap Safety

- Two Wheel, Galvanized Sprinkler Cart w/ Part Circle Sprinkler
- Sprinkler Cart Bracket for Transporting
- PTO Rewind for Emergency Roll Up of Hose
- Stabilizer Hitch to Hold Machine in Position
- Low Maintenance Wheel Bearings
- Easy Winter Draining Facilities
- 1 Year Machine Warranty & 3 Year, 100% Poly Tube Warranty

MR43

Part No.	Tube Inside Diameter	Tube Length	GPM	Sprinkler	Price
MR43	1.43"	393'	8-55	K1	
MR43HS*	1.43"	393'	8-55	K1	
MR43HC**	1.43"	393'	8-55	K1	
MR43BPP***	1.43"	393'	8-55	Hidra	
MR43SPP****	1.43"	393'	8-55	Hidra	

* High Speed

** High Cart

*** 5.5HP Honda Pull Start Boost Pump

**** Self Priming Supply Pump



MICRO RAIN TRAVELERS - LARGE-LINE

MR50

The MR50, 58, and 63 utilize the same chassis and drum size in our large line, and feature automatic cart lift at the completion of a run. The 558 feet of hose length on the MR50 is convenient for irrigating longer runs with wetted lengths up to 650 feet. A 5.5 or 9 HP booster kit may be added to increase pressure and performance. Common applications for the MR50 include golf course fairways, driving ranges, cemeteries, wildlife food plots, and municipal parks.

Standard Features:

- Three Wheel Chassis Design for Easy Towing
- Turbine Operated
- Automatic Retraction & Shutdown
- Automatic Cart Lift at Completion of Runs
- Speed Control for Desired Application Rates
- Speed Compensation
- Pressure Gauge to Determine Inlet Pressure
- Supply Hose (2" x 20')
- Scrolled Level-Wind to Facilitate Correct Tube Wrapping

- Tube Mis-Wrap Safety
- Galvanized, High Sprinkler Cart for Clearance in Tall Crops
- Part Circle Sprinkler
- Sprinkler Cart Bracket for Transporting
- PTO Rewind for Emergency Roll Up of Hose
- Stabilizer Legs
- Low Maintenance Wheel Bearings
- Easy Winter Draining Facilities
- 1 Year Machine Warranty & 3 Year, 100% Poly Tube Warranty

MR50

Part No.	Tube Inside Diameter	Tube Length	GPM	Sprinkler	Price
MR50	1.67"	558'	30-75	Hidra	
MR50w/5.5BPP*	1.67"	558'	30-75	Hidra	
MR50w/9BPP**	1.67"	558'	30-75	Hidra	
MR50w/5.5SPP***	1.67"	558'	30-75	Hidra	

* 5.5HP Honda Pull Start Boost Pump

** 9HP Honda Pull Start Boost Pump

*** 5.5HP Self Priming Supply Pump



1. ELECTRICAL 2. PUMP ACC. 3. HOSE, PE PIPE & ACC. 4. IPS, PIP PIPE & ACC. 5. SURFACE 6. SPRINKLERS 7. TRAVELER & WHEEL MOVE 8. PIVOT 9. TURF 10. LOW VOLUME 11. FILTERS 12. INJECTION 13. HARDWARE INDEX

MICRO RAIN TRAVELERS - LARGE-LINE

MR58

The MR58 carries 460 feet of tube length, and is a good fit for many applications. With flows up to 100 gallons per minute, the MR 58 is capable of watering up to 2 acres in a single pass! This model is widely used for larger sports fields, hobby farms, parks, polo fields, and more. A powerful 9 HP booster kit may be added for attaining maximum coverage.

Standard Features:

- Three Wheel Chassis Design for Easy Towing
- Turbine Operated
- Automatic Retraction & Shutdown
- Automatic Cart Lift at Completion of Runs
- Speed Control for Desired Application Rates
- Speed Compensation
- Pressure Gauge to Determine Inlet Pressure
- Supply Hose (2" x 20')
- Scrolled Level-Wind to Facilitate Correct Tube Wrapping
- Tube Mis-Wrap Safety
- Galvanized, High Sprinkler Cart for Clearance in Tall Crops
- Part Circle Sprinkler
- Sprinkler Cart Bracket for Transporting
- PTO Rewind for Emergency Roll Up of Hose
- Stabilizer Legs
- Low Maintenance Wheel Bearings
- Easy Winter Draining Facilities
- 1 Year Machine Warranty & 3 Year, 100% Poly Tube Warranty



MR58

Part No.	Tube Inside Diameter	Tube Length	GPM	Sprinkler	Price
MR58w/9BPP*	1.9"	460'	30-105	Hidra	
MR58w/5.5SPP**	1.9"	460'	30-105	Hidra	

* 9HP Honda Pull Start Boost Pump

** 5.5HP Honda Self Priming Supply Pump

MR58RL

The MR58RL is equipped with all of the great features of the Micro Rain line, and also includes a rotating base and heavy galvanized frame and chassis. The rotating base allows the user to position the machine in the center of the area to be irrigated, rotate the reel 90 degrees and make an initial pull with a 660 feet hose in one direction and upon completion, rotate the reel 180 degrees and make another pull in the opposite direction for a total of up to 1320 feet total length in a single setting! This model is now the largest in the Micro Rain line capable of effectively irrigating up to 25 acres in a wide variety of settings.

Standard Features:

- Heavy Duty Two Wheel Chassis Design for Easy Towing
- Turbine Operated
- Rotating Turntable
- Automatic Retraction & Shutdown
- Automatic Cart Lift at Completion of Runs
- Speed Control for Desired Application Rates
- Speed Compensation
- Pressure Gauge to Determine Inlet Pressure
- Supply Hose (2" x 20')
- Scrolled Level-Wind to Facilitate Correct Tube Wrapping
- Tube Mis-Wrap Safety

- Galvanized, High Sprinkler Cart for Clearance in Tall Crops
- Part Circle Sprinkler
- Sprinkler Cart Bracket for Transporting
- PTO Rewind for Emergency Roll Up of Hose
- Stabilizer Legs
- Low Maintenance Wheel Bearings
- Easy Winter Draining Facilities
- 1 Year Machine Warranty & 3 Year, 100% Poly Tube Warranty

MR58RL

Part No.	Tube Inside Diameter	Tube Length	GPM	Sprinkler	Price
MR58RL*	1.9"	660'	30-90	Hidra	
MR58RLBPP**	1.9"	660'	30-90	Hidra	
MR58RLSPH***	1.9"	660'	30-90	Hidra	

* RL = Turntable Model

** BPP = 9 HP Honda Pull Start Boost Pump

*** SPH = 13 HP Honda Supply Pump

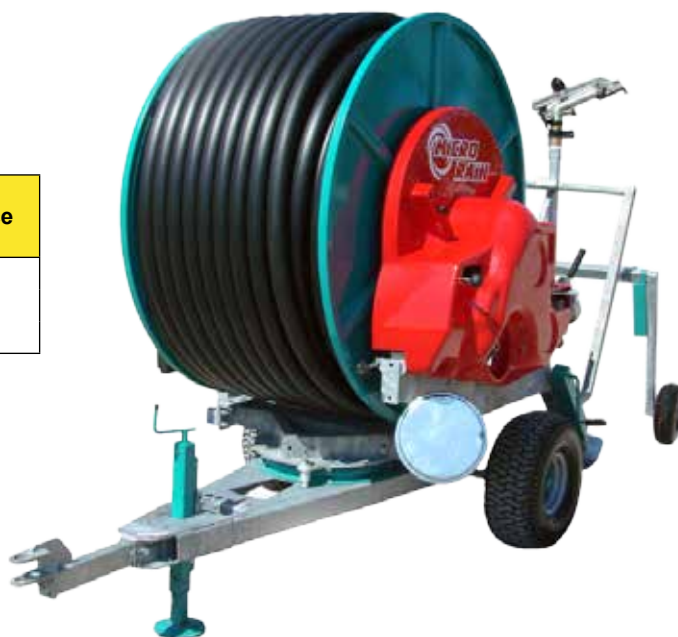

MICRO RAIN TRAVELERS - LARGE-LINE

MR63

The MR63 is capable of delivering the largest volume of water in the Micro Rain line! This model boasts a large diameter 2.1 inch hose that is 328 feet in length. If large amounts of water are available for use, the MR63 can utilize up to 140 gallons per minute for the serious irrigator. Uses for the MR63 include football fields with both natural and artificial surfaces where large amounts of water need to be applied in a short amount of time. Vegetable farms, sod farms, and equestrian facilities with large arenas also benefit from the MR63's ability to irrigate over 200 feet widths and up to 450 feet in length.

Standard Features:

- Three Wheel Chassis Design for Easy Towing
- Turbine Operated
- Automatic Retraction & Shutdown
- Automatic Cart Lift at Completion of Runs
- Speed Control for Desired Application Rates
- Speed Compensation
- Pressure Gauge to Determine Inlet Pressure
- Supply Hose (2" x 20')
- Scrolled Level-Wind to Facilitate Correct Tube Wrapping
- Tube Mis-Wrap Safety
- Galvanized, High Sprinkler Cart for Clearance in Tall Crops
- Part Circle Sprinkler
- Sprinkler Cart Bracket for Transporting
- PTO Rewind for Emergency Roll Up of Hose
- Stabilizer Legs
- Low Maintenance Wheel Bearings
- Easy Winter Draining Facilities
- 1 Year Machine Warranty & 3 Year, 100% Poly Tube Warranty



MR63

Part No.	Tube Inside Diameter	Tube Length	GPM	Sprinkler	Price
MR63	2.1"	328'	30-150	Hidra	
MR63w/9BPP*	2.1"	328'	30-150	Hidra	
MR63w/5.5SPP**	2.1"	328'	30-150	Hidra	

* 9HP Honda Pull Start Boost Pump

** 5.5HP Honda Self Priming Supply Pump

MICRO RAIN TRAVELERS - ENGINE DRIVE - MID-LINE & LARGE-LINE

Engine Drive Micro Rain Travelers

Micro Rain Engine Drive travelers are a great choice for watering artificial turf, arenas, and dewatering lagoons. These Micro Rain travelers come equipped with a 3 HP Honda engine and with a digital tachometer for monitoring speed. Micro Rain's new engine drive travelers have the capability to reach speeds over 500 feet per hour, thus making them ideal for jobs requiring low application rates. Micro Rain's engine drive travelers come standard with a gearbox, 7-gallon fuel tank, automatic water and engine shut down, galvanized sprinkler cart, PTO rewind, and a 20-foot supply hose.

Standard Features:

- 3 HP Honda Engine Drive with Gearbox
- Engine Tachometer
- 7 Gallon Fuel Tank
- Automatic Water Shutdown
- Automatic Engine Shutdown
- Scrolled Hose Guide
- Galvanized Hitch
- PTO Rewind
- 20 ft. Supply Hose
- Part Circle Sprinkler for M50, MR58, & MR63



ENGINE DRIVE MICRO RAIN TRAVELERS

Part No.	Tube Inside Diameter	Tube Length	Sprinkler	Price
MR43E	1.43"	393'	K1	
MR50E	1.67"	558'	Hidra	
MR58E	1.90"	460'	Hidra	
MR63E	2.10"	328'	Hidra	



MICRO RAIN TRAVELERS - PERFORMANCE SUMMARY



2012 PERFORMANCE SUMMARY													
Part No.	GPM	Inlet PSI	Nozzle Size mm	Total Width Ft.	Irrigated Width (80%) Ft.	Max. Length Ft.	Acres Per Pull	Retraction Rate (Ft./Hour) @ Application Depth					
								0.25"	0.50"	0.75"	1.0"	1.5"	2.0"
MR25 (0.8" x 165')	3.2	35	4	72	58	201	0.27	21					
	5.9	50	5	86	69	207	0.33	33					
	9.5	65	6	98	78	214	0.38	46	23				
MR32 (1" x 242')	7.5	45	6	90	72	287	0.47	40					
	11.1	60	7	98	78	291	0.52	55					
	16	75	8	112	90	298	0.62	69	35				
	21	95	9	123	98	304	0.68	83	42				
MR32 ULTRA DRIVE (1" x 242')	23.9	105	10	121	97	303	0.67	95	48				
	2.8	25	3	70	56	277	0.36	19					
	4	35	4	85	68	285	0.44	23					
	10.4	55	6	108	86	296	0.58	47	23				
	19.3	75	8	129	103	307	0.73	72	36	24			
MR43 (1.43" x 393')	25.8	95	9	135	108	310	0.77	92	46	31	23		
	30	105	10	135	108	310	0.77	108	54	36	27		
	9.4	45	6	100	80	443	0.81	45					
	13.1	55	7	109	87	448	0.89	58	29				
	20.7	75	8	132	106	459	1.12	76	38	25			
MR50 (1.67" x 558')	28.7	95	9	146	117	466	1.25	95	48	32			
	36.5	105	10	153	122	470	1.32	119	60	40	30		
	53.1	115	12H	178	142	482	1.57	149	75	50	38		
	26	45	10	118	94	619	1.33	106	53	35			
MR58 (1.9" x 460')	43	65	10	133	106	627	1.53	120	60	40	30		
	49	85	12	157	126	639	1.85		75	50	38	25	
	56	105	12	179	143	650	2.13		76	51	38	25	
	70	115	14	182	146	651	2.18		93	62	47	31	
	41	55	12	140	112	530	1.36		71	47	36	24	
MR58RL (1.9" x 660')	51	75	12	163	130	542	1.62		76	51	38	26	
	74	95	14	191	153	556	1.95		93	62	47	31	
	81	115	14	200	160	560	2.06		98	65	49	33	
	101	125	16	207	166	564	2.15		118	79	59	40	
	40	55	12	132	106	726	1.75		73	49	37	25	
MR63 (2.1" x 328')	48	75	12	156	125	738	2.11		74	49	37	25	
	67	95	14	172	138	746	2.36		94	63	47	32	
	75	115	14	194	155	757	2.69		93	62	47	31	
	90	125	16	192	154	756	2.67		85	57	43	29	
	45	55	12	148	118	402	1.09		73	49	37	25	
	69	75	14	181	145	419	1.39		92	61	46	31	23
	96	95	16	203	162	430	1.60		85	57	43	29	21
	121	105	18	220	176	438	1.77		99	66	50	33	25
	147	125	20	260	208	458	2.19		102	68	52	34	26

NOTE: These specifications are for a guide only and are based on theoretical calculations and performance tests. This is to be used as a guide only, as performance may vary under field conditions.
 MR43 Note: H = Hidra Sprinkler

KID UPGRADE = 8 gallon fuel tank, flow switch control (auto kill) system, override switch

HONDA 18 HP HIGH PRESSURE PUMP (ELECTRIC START)

Part No.	Description	Price
MON-18-PO	18 HP Pump/Engine on Skid 2.5 Inch Discharge and Suction	

PERFORMANCE CHART

GPM	25	50	75	100	125	150	175	200	225
PSI	111	108	104	100	93	86	78	67	56

Performance is at 5 Ft. Suction Lift



BRIGGS & STRATTON 13 HP HIGH PRESSURE PUMP (PULL START)

Part No.	Description	Price
FP25V-13-PO	13 HP Briggs Pump Only	
FP25V-13-KID	13 HP Briggs Pump w/ KID Upgrade	
FP25V-13-KID-TM	13 HP Briggs Pump -Trailer Mount with KID Upgrade	

PERFORMANCE CHART

GPM	25	50	75	100	125
PSI	110	104	95	85	70

Performance is at 5 Ft. Suction Lift

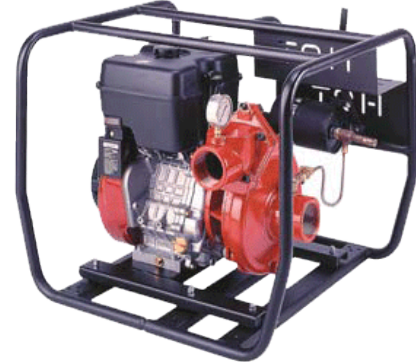

HONDA 13 HP HIGH PRESSURE PUMP (PULL START)

Part No.	Description	Price
FP25H-13-PO	13 HP Honda Pump Only	
FP25H-13-KID	13 HP Honda Pump w/ KID Upgrade	
FP25H-13-KID-TM	13 HP Honda Pump -Trailer Mount with KID Upgrade	

PERFORMANCE CHART

GPM	25	50	75	100	125
PSI	110	104	95	85	70

Performance is at 5 Ft. Suction Lift

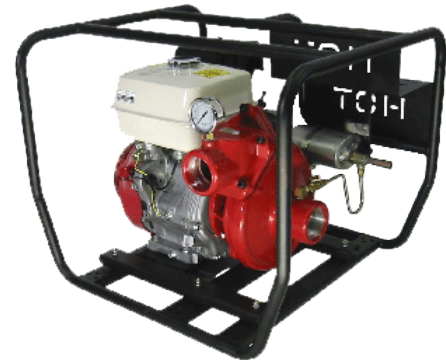

9.1 HP YANMAR DIESEL HIGH PRESSURE PUMP (ELECTRIC START)

Part No.	Description	Price
FP25YE-9.1-PO	9.1 HP Yanmar Pump Only	
FP25YE-9.1-KID	9.1 HP Yanmar Pump w/ KID Upgrade	
FP25YE-9.1-KID-TM	9.1 HP Yanmar Pump -Trailer Mount with KID Upgrade	

PERFORMANCE CHART

GPM	25	50	75	100	125
PSI	110	104	95	85	70

Performance is at 5 Ft. Suction Lift



Sample of a trailer mount with KID upgrade



5.5 HP DAVEY TWO-STAGE SELF-PRIME PUMP

Part No.	Description	Price
DAV-5.5-PO	5.5 HP Davey Pump Only	
DAV-5.5-KID	5.5 HP Davey Pump w/KID Upgrade	
DAV-5.5-KID-WK	5.5 HP Davey Pump w/KID Upgrade and Wheel Kit	

PERFORMANCE CHART

GPM	10	20	30	40	50	60
PSI	117	110	100	89	70	53

Performance is at 5 Ft. Suction Lift



5.5 HP IPT SELF-PRIMING PUMP

Part No.	Description	Price
IPT-5.5-PO	5.5 HP IPT Pump Only	
IPT-5.5-KID	5.5 HP IPT Pump w/KID Upgrade	
IPT-5.5-KID-WK	5.5 HP IPT Pump w/ KID Upgrade and Wheel Kit	

PERFORMANCE CHART

GPM	20	40	60
PSI	80	72	58

Performance is at 5 Ft. Suction Lift



5.5 HP HONDA / MONARCH PORTABLE BOOSTER PUMP

Part No.	Description	Price
MON-5.5-PO	5.5 HP Monarch Boost Pump Only	
MON-5.5-KID	5.5 HP Monarch Boost Pump w/KID Upgrade	
MON-5.5-KID-WK	5.5 HP Monarch Boost Pump w/KID Upgrade and Wheel Kit	

PERFORMANCE CHART

GPM	20	30	40	60
PSI	66	62	59	51

Performance is at 5 Ft. Suction Lift



3/4 HP ELECTRIC BOOSTER PUMP

Part No.	Description	Price
DAV-XF14-30	3/4 HP Davey Boost Pump	
DAV-XF14-30-BPC	3/4 HP Davey Boost Pump w/Cover	
0071K	Hose & Fittings Kit To Connect MR25	
0070K	Hose & Fittings Kit To Connect MR32	

PERFORMANCE CHART

GPM	5	10	15	20
PSI	36	33	29	25

3/4 HP 120V Motor
 1" Discharge and 1-1/4" Suction
 Flow Sensor Shutoff
 Flow Sensor Preset: On at 1.2 GPM, off at 0.7 GPM



1 HP ELECTRIC BOOSTER PUMP

Part No.	Description	Price
DAV-BF14-45	1 HP Davey Boost Pump	
DAV-BF14-45-BPC	1 HP Davey Boost Pump w/Cover	
0076K	Hose & Fittings Kit To Connect MR32	

PERFORMANCE CHART

GPM	5	10	15	20
PSI	53	47	40	30

1 HP 120V Motor
 1" Discharge and 1" Suction
 Flow Sensor Shutoff



1.5 HP 220 V ELECTRIC BOOSTER PUMP

Part No.	Description	Price
DAV-BF20-40	1.5 HP 220V Davey Boost Pump	
DAV-BF20-40-BPC	1.5 HP Davey Boost Pump w/Cover	
0076K	Hose & Fittings Kit To Connect MR32	

PERFORMANCE CHART

GPM	5	10	15	20	25
PSI	70	63	54	40	18

1.5 HP 220V Motor
 1" Discharge and 1" Suction
 Flow Sensor Shutoff



ELECTRIC BOOSTER PUMP COVER

Part No.	Description	Price
BI-BPC-1225-C4	Electric Boost Pump Cover	



HONDA 5.5 HP MICRO RAIN MOUNTED BOOST PUMP

Part No.	GPM	PSI	Price
1020K	20	66	

PERFORMANCE CHART

GPM	20	30	40	60
PSI	66	62	59	51

5.5 HP
 2" Discharge and Suction
 Pull or Electric Start
 MR43 and MR50 Machine Mount Only
 NOTE: Optional Electric Starter is available.
 Please call for price.

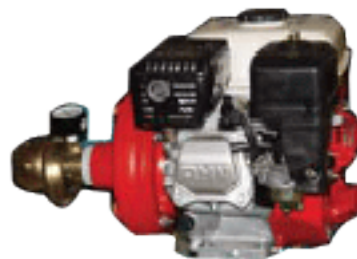

PTO DIRECT COUPLE ROVATTI

Part No.	Description	GPM	PSI	Price
TOF50	Standard Centrifugal Pump	20-150	65-75	
TOF50A	Self Priming Centrifugal Pump	20-120	40-55	

Both pumps come with a 2" foot valve, 2" suction fitting, and 2" discharge fitting for hose connection. Tractor anchor bar and PTO coupling included.



ROVATTI PTO TRAILER OR 3 POINT PUMPS (HAND PRIME)

Part No.	GPM	PSI	Bare Pump	Build 1	Build 2 Complete
T1/40	50-150	140-150			
T2/50	50-300	130-150			
T3/80	150-450	165-175			
T3/100	200-800	80-112			
T4/100(540 or 1000)	250-800	140-180			
T4/125(540 or 1000)	500-1050	110-125			

BARE PUMP = Pump with weld-on flanges and bolts
 BUILD #1 = Pump with weld-on flanges, KID pump cart, and drive shaft
 BUILD #2 = Pump with weld-on flanges, KID pump cart, drive shaft, hand primer, discharge priming valve, threaded fittings on suction



"KID POWER" PRIMER ROVATTI ON TRAILER

Part No.	GPM	PSI	Complete Pump
T2/50	50-300	130-150	
T3/80	150-450	165-175	
T3/100	200-800	80-112	
T4/100(540)	250-800	140-180	
T4/100(1000)	250-800	140-180	
T4/125(540)	500-1050	110-125	
T4/125(1000)	500-1050	110-125	

Pumps come complete with flanges, POWER PRIMER, discharge gate valve, trailer, drive shaft, and threaded outlet both on suction and discharge.



ROVATTI DIRECT ENGINE MOUNT

Part No.	GPM	PSI	Pump End Only
F34P150K-M	500-1250	100-114	
F33K80-60/4	150-350	110-180	
F33K100/2	250-650	136-168	

Pumps come with weld-on flanges and bolts, with elastic joint for flywheel.



WHEEL MOVE SYSTEMS

COMPLETE WHEEL MOVE SYSTEMS

Specify length, pipe size, wheel size and brand when ordering - Pierce, Travis, Western, A&M, etc.



WHEEL MOVE HYDRAULIC MOVERS

SIDE ROLL MOVERS

Part No.	Description	Price
2-8200	Single Rail Style Mover	
118000	Twin Rail Style Mover	

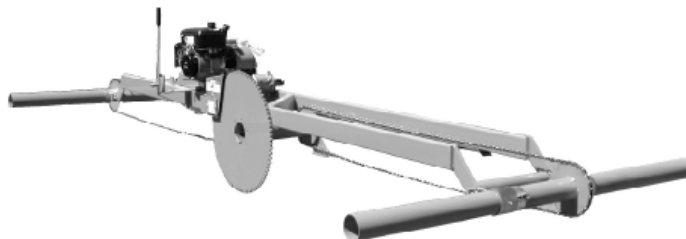

Note: Hydraulic oil, cover and wheels NOT included.

WHEEL MOVE FITTINGS & PARTS

HINGED PLASTIC COVER

Part No.	Description	Price
CVR	Plastic Cover Only	
CVR/H	Plastic Cover with Hinge	



AMRAD FLANGE ADAPTER

Part No.	Description	Price
AMRAD-4R	4" Flange Adapter - Includes nuts, bolts & flange gasket	
AMRAD-5R	5" Flange Adapter - Includes nuts, bolts & flange gasket	
AMRAD-4G	4" & 5" Flange Gasket	



ALUMINUM WHEEL MOVE TORQUE (WMT) COUPLER SET WESTERN O-RING STYLE

Part No.	Description	Price
WMT 400	4" Aluminum Wheel Move Torque Coupler - Mushroom Drain	
WMT (FD) 400	4" Aluminum Wheel Move Torque Coupler - Flap Drain	
WMT 500	5" Aluminum Wheel Move Torque Coupler - Mushroom Drain	
WMT (FD) 500	5" Aluminum Wheel Move Torque Coupler - Flap Drain	



ALUMINUM WHEEL MOVE TORQUE MALE END (WMT-M) WESTERN O-RING STYLE

Part No.	Description	Price
WMT-M 400	4" Aluminum Male End WMT-M - Mushroom Drain	
WMT-M (FD) 400	4" Aluminum Male End WMT-M - Flap Drain	
WMT-M 500	5" Aluminum Male End WMT-M - Mushroom Drain	
WMT-M (FD) 500	5" Aluminum Male End WMT-M - Flap Drain	



ALUMINUM WHEEL MOVE TORQUE FEMALE END (WMT-F) WESTERN O-RING STYLE

Part No.	Description	Price
WMT-F 400	4" Aluminum Female End WMT-F - Includes O-Ring	
WMT-F 500	5" Aluminum Female End WMT-F - Includes O-Ring	



INTRO
 1. ELECTRICAL
 2. PUMP ACC.
 3. HOSE, PE PIPE & ACC.
 4. IPS, PIP PIPE & ACC.
 5. SURFACE
 6. SPRINKLERS
 7. TRAVELER & WHEEL MOVE
 8. PIVOT
 9. TURF
 10. LOW VOLUME
 11. FILTERS
 12. INJECTION
 13. HARDWARE
 INDEX

WHEEL MOVE FITTINGS & PARTS

ALUMINUM MANUAL FLUSHING END PLUG - WESTERN O-RING STYLE

Part No.	Description	Price
CEP-FF	4" & 5" Aluminum Manual Flushing End Plug - O-Ring Female	
CEP-FM	4" & 5" Aluminum Manual Flushing End Plug - Riser Outlet Male	
FEPC	Splash Pan	
FEPH&S	Handle & Stem	



ALUMINUM TELESCOPING ADAPTER (WMT-T) - WESTERN O-RING STYLE

Part No.	Description	Price
WMT-TF 403	4" x 3" Aluminum Telescoping Adapter - O-Ring Female	
WMT-TM 403	4" x 3" Aluminum Telescoping Adapter - Riser Outlet Male	
WMT-TF 504	5" x 4" Aluminum Telescoping Adapter - O-Ring Female	
WMT-TM 504	5" x 4" Aluminum Telescoping Adapter - Riser Outlet Male	



ALUMINUM CENTER INLET TEE - WESTERN O-RING STYLE

Part No.	Description	Price
WMT-CFT 400	4" or 5" Aluminum Center Inlet Tee - 4" Latch Type Inlet	



HEAVY DUTY STEEL TORQUE CLAMP - WESTERN O-RING STYLE

Part No.	Description	Price
WMT-C	4" & 5" Heavy Duty Steel Torque Clamp - WMT & WMT-W	
WMT-CBS	4" & 5" Heavy Duty Steel Torque Clamp - Spring Only	



WHEEL MOVE FITTINGS & PARTS

ALUMINUM QUICK BREAKDOWN COUPLER ASSEMBLY WESTERN O-RING STYLE

Part No.	Description	Price
WMT-D 400	4" Aluminum Quick Breakdown Coupler Assembly	
WMT-D 500	5" Aluminum Quick Breakdown Coupler Assembly	



ALUMINUM FEMALE COUPLER WITHOUT O-RING GROOVE WESTERN O-RING STYLE

Part No.	Description	Price
WMT-DF 400	4" Aluminum Female Coupler without O-Ring Groove	
WMT-DF 500	5" Aluminum Female Coupler without O-Ring Groove	



ALUMINUM DEMOUNTABLE FLANGE ADAPTER WESTERN O-RING STYLE

Part No.	Description	Price
WMT-DFA-F 500	4" & 5" Aluminum Demountable Flange Adapter - Female End	
WMT-DFA-M 500	4" & 5" Aluminum Demountable Flange Adapter - Male End	
DFA-FL	Flange Only	

Note: Includes nuts, bolts & flange gasket.



ALUMINUM WELD ON WHEEL MOVE TORQUE (WMT-W) COUPLER WESTERN O-RING STYLE

Part No.	Description	Price
WMT-W 500	5" Aluminum Weld On Wheel Move Torque (WMT-W) Coupler	



ALUMINUM WELD ON WHEEL MOVE TORQUE (WMT W-M) MALE END WESTERN O-RING STYLE

Part No.	Description	Price
WMT W-M 500	5" Aluminum Weld On Wheel Move Torque (WMT-W-M) Male End	



ALUMINUM WELD ON WHEEL MOVE TORQUE (WMT W-F) FEMALE END WESTERN O-RING STYLE

Part No.	Description	Price
WMT W-F 500	5" Aluminum Weld On Wheel Move Torque (WMT-W-F) Female End	



WHEEL MOVE FITTINGS & PARTS

WHEEL MOVE SUPPLY HOSE WITH FITTINGS

Part No.	Description	Price
W670-4MM	4" x 20' Supply Hose with Fittings - Male End x Male End	
W670-4MF	4" x 20' Supply Hose with Fittings - Male End x Female End	



GALVANIZED STEEL HOSE END - INVERTED GROOVE - RAINWAY LATCH

Part No.	Description	Price
W660-4M	4" Rainway Male Hose End - Includes B/L & Two Hose Clamps	
W660-4F	4" Rainway Female Hose End - Includes Two Hose Clamps	

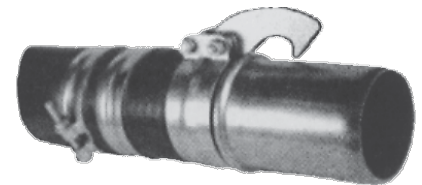

Note: Refer to Section 3 for other hose end options.

INVERTED HOSE END CLAMP

Part No.	Description	Price
WHC-4	4" Inverted Hose End Clamp	

Note: Refer to Section 3 for other hose clamp options.



WHEEL MOVE SUPPLY HOSE

Part No.	Description	Price / Ft.
W-670-4	4" Wheel Move Supply Hose	

Note: Refer to Section 3 for other hose options.



FLAPPER TYPE DRAIN VALVE

Part No.	Description	Price
FD-100	Flapper Type Drain Valve - Complete	
FD-SPLASHNUT	Flapper Type Drain Valve - Splash Nut Only	
FD-FLAPPER	Flapper Type Drain Valve - Rubber Flapper Only	
FD-INSERT	Flapper Type Drain Valve - Insert Only	
FD-JAMNUT	Flapper Type Drain Valve - Jam Nut Only	

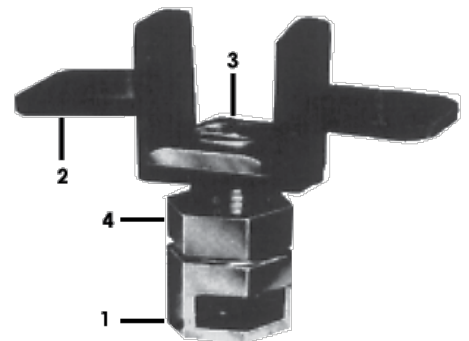

MUSHROOM DRAIN

Part No.	Description	Price
D-2-5	Drain Only	
D-2-4 SC	Clip Only	



WHEEL MOVE FITTINGS & PARTS

WHEEL MOVE SPRINKLER LEVELER

Part No.	Description	Price
L-75	3/4" Wade Rain Sprinkler Leveler	
LEV75	3/4" XCAD Sprinkler Leveler	

Note: Repair parts available



XCAD LEVELER REBUILD KIT

Part No.	Description	Price
LEVRK	120 Piece Kit Contains: 20 - Lev02 Neoprene Washers 40 - Lev03 Teflon Washers 20 - Lev05 O-Rings 20 - Lev06 Retaining Washers 20 - Lev07 Snap Rings	

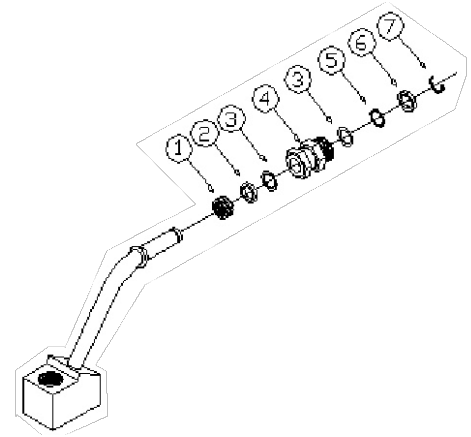

XCAD INDIVIDUAL LEVELER REPAIR COMPONENTS

Part No.	Description	Price
LEV01	Stainless Bearing Spring	
LEV02	Neoprene Washer	
LEV03	Teflon Washer	
LEV04	Brass Spindle	
LEV05	O-Ring	
LEV06	Retaining Washer	
LEV07	Snap Ring	

WHEEL MOVE SLIDE BAND

Part No.	Description	Price
B 303	3" Adjustable Slide Band Assembly	
B 404	4" Adjustable Slide Band Assembly	



WHEEL MOVE RISER ELBOW

Part No.	Description	Price
RE 1X3/4	1" MPT x 3/4" FPT X 90° Galvanized Riser Elbow	
MAL-110-090	1" MPT x 3/4" FPT X 90° Aluminum Riser Elbow	
ZMGBU0504	1" MPT x 3/4" FPT Galvanized Hex Bushing	
ZNG046	3/4" x 6" Galvanized Nipple	
ZMGL9004	3/4" x 90° Galvanized Elbow	



HOLD BANDS

Part No.	Description	Price
HB-300	3" Aluminum Hold Band	
HB-400	4" Aluminum Hold Band	
HB-500	5" Aluminum Hold Band	
HB-600	6" Aluminum Hold Band	
HB-800	8" Aluminum Hold Band	
HB-1000	10" Aluminum Hold Band	
HB-1200	12" Aluminum Hold Band	
SHB4	4" Steel Hold Band	
SHB5	5" Steel Hold Band	
SHB10	10" Steel Hold Band	
SHB12	12" Steel Hold Band	



INTRO | 1. ELECTRICAL | 2. PUMP ACC. | 3. HOSE, PE PIPE & ACC. | 4. IPS, PIP PIPE & ACC. | 5. SURFACE | 6. SPRINKLERS | 7. TRAVELER & WHEEL MOVE | 8. PIVOT | 9. TURF | 10. LOW VOLUME | 11. FILTERS | 12. INJECTION | 13. HARDWARE | INDEX

WHEEL MOVE FITTINGS & PARTS

COMPLETE WHEEL ASSEMBLY

Part No.	Description	Price
WXN 4152	4" Hub x 58" Wheel x 18 Gauge Complete Wheel Assembly	
WXN 5152	5" Hub x 58" Wheel x 18 Gauge Complete Wheel Assembly	
WXN 4162	4" Hub x 64" Wheel x 18 Gauge Complete Wheel Assembly	
WXN 5162	5" Hub x 64" Wheel x 18 Gauge Complete Wheel Assembly	
WXN 4172	4" Hub x 76" Wheel x 18 Gauge Complete Wheel Assembly	
WXN 5172	5" Hub x 76" Wheel x 18 Gauge Complete Wheel Assembly	
*WX 4184	4" Hub x 96" Wheel x 16 Gauge Complete Wheel Assembly	
*WX 5184	5" Hub x 96" Wheel x 16 Gauge Complete Wheel Assembly	
*WX 41101	4" Hub x 120" Wheel x 16 Gauge Complete Wheel Assembly	
*WX 51101	5" Hub x 120" Wheel x 16 Gauge Complete Wheel Assembly	

NOTE: Includes 8 cleats for 5' & 6' wheels, 10 cleats for 7' & 8' wheels & 20 cleats for 10' wheels.
* Call for availability.



RIM HALF

Part No.	Description	Price
750088	58" x 18 Gauge Rim Half	
750091	64" x 18 Gauge Rim Half	
750094	76" x 18 Gauge Rim Half	
*100011	96" x 16 Gauge Rim Half	
*100060	120" x 16 Gauge Rim Half	

NOTE: 2 required per wheel. * Call for availability.



HUB HALF

Part No.	Description	Price
750070	4" Hub Half	
750071	5" Hub Half	

NOTE: 4 required per wheel.



WHEEL SPOKES - ZINC PLATED

Part No.	Description	Price
WS 54	27-1/4" Spoke for 4" Hub x 58" Wheel	
WS 55	26-7/8" Spoke for 5" Hub x 58" Wheel	
WS 6	30-1/2" Spoke for 4" or 5" Hub x 64" Wheel	
WS7	37" Spoke for 4" or 5" Hub x 76" Wheel	
*100077	46-7/8" Spoke for 4" or 5" Hub x 96" Wheel	
*100078	56-3/4" Spoke for 4" or 5" Hub x 120" Wheel	

NOTE: 16 required for 58" & 64" wheels, 20 required for 76", 96" & 120" wheels.
Measured end to end. * Call for availability.



WHEEL MOVE FITTINGS & PARTS

WHEEL CLEATS

Part No.	Description	Price
WC-11-3	Galvanized Steel Cleat	



CAP SCREWS AND HEX NUTS

Part No.	Description	Price
C 1-3/8 x 1	3/8" x 1" Cap Screw	
N 1-3/8	3/8" Hex Nut	



WIND BRACES

Part No.	Description	Price
WWB 405	4" x 5' Wind Brace	
WWB 407	4" x 6' or 7' Wind Brace	
WWB 505	5" x 5' Wind Brace	
WWB 507	5" x 6' or 7' Wind Brace	



RATCHETED LINE ANCHOR STABILIZER BAR

Part No.	Description	Price
22-4-57	4" x 5' Ratcheted Line Anchor Stabilizer Bar	
22-4-76	4" x 6' or 7' Ratcheted Line Anchor Stabilizer Bar	
22-5-57	5" x 5' Ratcheted Line Anchor Stabilizer Bar	
22-5-76	5" x 6' or 7' Ratcheted Line Anchor Stabilizer Bar	



GALVANIZED REPAIR SLEEVE - (PRESS-ON FOR ALUMINUM PIPE)

Part No.	Description	Price
SRS300	3" x 7" Galvanized Steel Repair Sleeve	
SRS300 L	3" x 10" Galvanized Steel Repair Sleeve	
SRS400	4" x 7" Galvanized Steel Repair Sleeve	
SRS400 L	4" x 10" Galvanized Steel Repair Sleeve	
SRS500	5" x 7" Galvanized Steel Repair Sleeve	
SRS500 L	5" x 10" Galvanized Steel Repair Sleeve	
SRS600	6" x 10" Galvanized Steel Repair Sleeve	
SRS700	7" x 10" Galvanized Steel Repair Sleeve	
SRS800	8" x 10" Galvanized Steel Repair Sleeve	
SRS1000	10" x 10" Galvanized Steel Repair Sleeve	

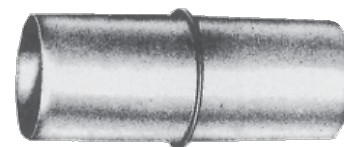

INTRO
1. ELECTRICAL
2. PUMP Acc.
3. HOSE, PE PIPE & Acc.
4. IPS, PIP PIPE & Acc.
5. SURFACE
6. SPRINKLERS
7. TRAVELER & WHEEL MOVE
8. PIVOT
9. TURF
10. LOW VOLUME
11. FILTERS
12. INJECTION
13. HARDWARE
INDEX

WHEEL MOVE FITTINGS & PARTS

ALUMINUM QUICK DISCONNECT COUPLER A & M SQUARE O-RING STYLE

Part No.	Description	Price
CX 4463	4" Aluminum Quick Disconnect Coupler - Flap Drain	
CX 5563	5" Aluminum Quick Disconnect Coupler - Flap Drain	



ALUMINUM QUICK DISCONNECT MALE COUPLER A & M SQUARE O-RING STYLE

Part No.	Description	Price
C 4463M	4" Aluminum Quick Disconnect Male Coupler - Flap Drain	
C 5563M	5" Aluminum Quick Disconnect Male Coupler - Flap Drain	



ALUMINUM QUICK DISCONNECT FEMALE COUPLER A & M SQUARE O-RING STYLE

Part No.	Description	Price
C 4463F	4" Aluminum Quick Disconnect Female Coupler - Includes O-Ring	
C 5563F	5" Aluminum Quick Disconnect Female Coupler - Includes O-Ring	

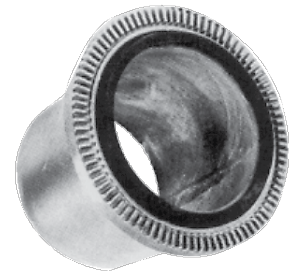

HEAVY-DUTY STEEL RING LOCK CLAMP A & M STYLE

Part No.	Description	Price
RLT 4463	4" & 5" Heavy-Duty Steel Ring Lock Clamp	



ALUMINUM DEMOUNTABLE FLANGE ADAPTER A & M SQUARE O-RING STYLE

Part No.	Description	Price
PMA 563	4" x 5" Aluminum Demountable Flange Adapter - Gasket Included	

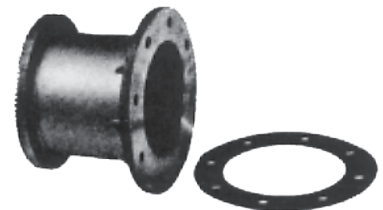

WHEEL MOVE FITTINGS & PARTS

ALUMINUM FLUSHING END PLUG A & M SQUARE O-RING STYLE

Part No.	Description	Price
WEPV 4463M	4" Aluminum Flushing End Plug - Riser Outlet Male	
WEPV 4463F	4" Aluminum Flushing End Plug - O-Ring Female	



ALUMINUM TELESCOPING ADAPTER A & M SQUARE O-RING STYLE

Part No.	Description	Price
MA 4363	4" x 3" Aluminum Telescoping Adapter - Riser Outlet Male	
MA 4463	4" x 4" Aluminum Telescoping Adapter - Riser Outlet Male	
MA 5463	5" x 4" Aluminum Telescoping Adapter - Riser Outlet Male	
MA 5563	5" x 5" Aluminum Telescoping Adapter - Riser Outlet Male	
FA 4363	4" x 3" Aluminum Telescoping Adapter - O-Ring Female	
FA 4463	4" x 4" Aluminum Telescoping Adapter - O-Ring Female	
FA 5463	5" x 4" Aluminum Telescoping Adapter - O-Ring Female	
FA 5563	5" x 5" Aluminum Telescoping Adapter - O-Ring Female	



ALUMINUM CENTER FEED TEE A & M SQUARE O-RING STYLE

Part No.	Description	Price
T 55463	4" & 5" Aluminum Center Feed Tee - 4" Latch Type Inlet	



O-RINGS

Part No.	Description	Price
ORG	4-7/8" OD x 4-1/2" ID - Fits Travis/Western Aluminum - Round	
200463	5" OD x 4-3/8" ID - Fits A & M - Round	
200470	5" OD x 4-1/2" ID - Fits A & M - Square	
200424	4-7/8" OD x 4-3/8" ID - Fits Trunnell Steel - Quad	
200425	5-7/8" OD x 5-1/4" ID - Fits Trunnell Steel - Quad	
200426	5" OD x 4-1/2" ID - Fits Trunnell Aluminum - Quad	
300464	5" OD x 4-3/4" ID - Fits Western Steel	



Note: Additional O-Rings and Quad Rings are listed at the end of the Gasket pages in Section 5.

INTRO
1. ELECTRICAL
2. PUMP Acc.
3. HOSE, PE Pipe & Acc.
4. IPS, PIP Pipe & Acc.
5. SURFACE
6. SPRINKLERS
7. TRAVELER & WHEEL MOVE
8. PIVOT
9. TURN
10. LOW VOLUME
11. FILTERS
12. INJECTION
13. HARDWARE
INDEX

SINGLE RAIL MOVER ASSEMBLY

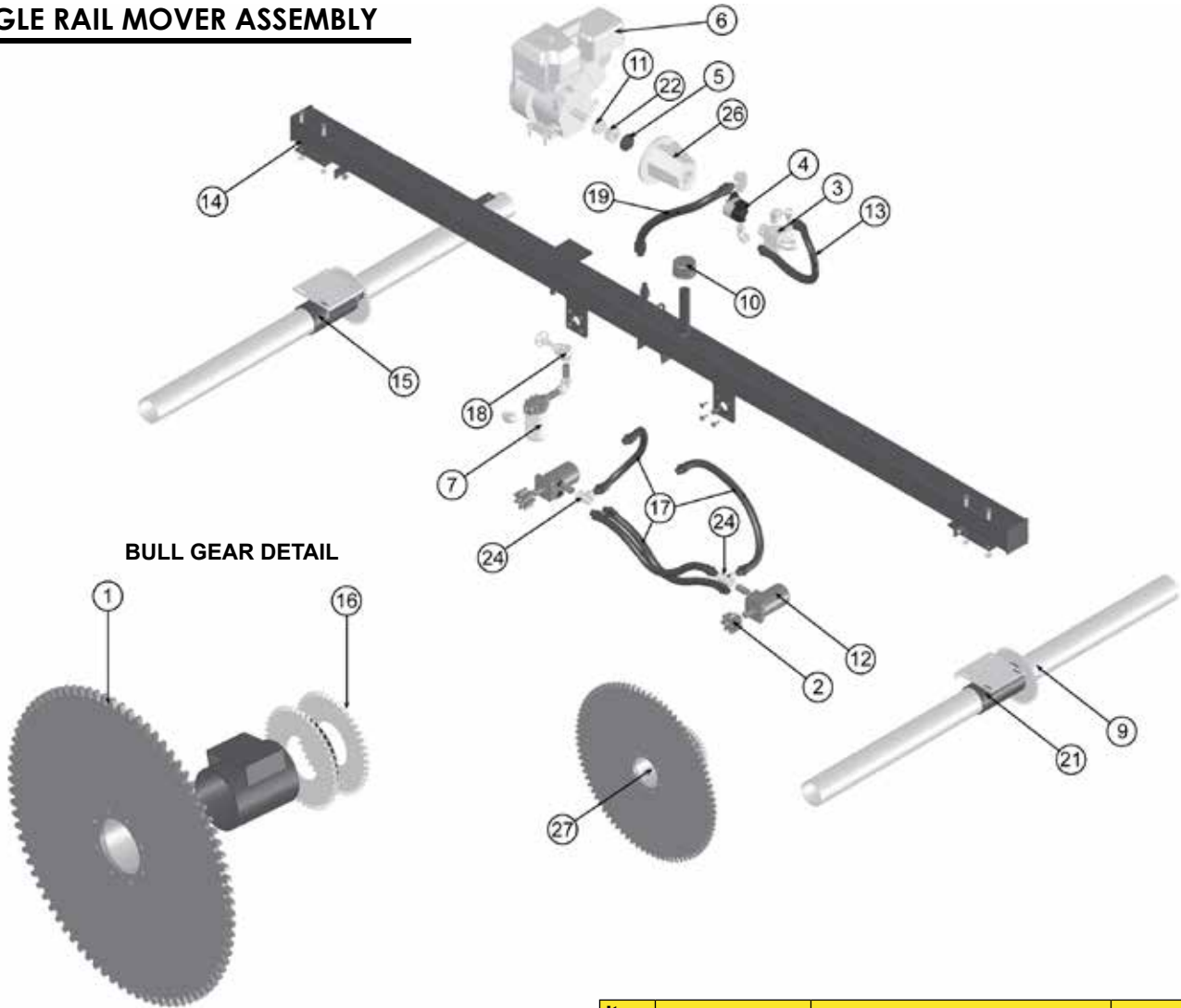

Item No.	Part No.	Description	Price
1	113046	Bull Gear	
2	113044	Orbit Motor Gear	
3	113081	Hydraulic Control Valve Assembly	
3B	113010	Valve Only	
4	113083	Hydraulic Pump Assembly	
4B	113011	Pump Only	
5	113309	4-J Flange 1/2"	
6	113260	8 H.P. Engine	
7	113016	Canister Filter Assembly	
8	113266	Roller Chain #50 (not shown)	
9	113070	Axle w / Drive Sprocket	
10	113267	Breather Cap	
11	113308	4-J Flange 1"	
12	113013	Orbit Motor K	
13	113023	Discharge Hose 3/8" x 20"	
14	113186	Stringer Adjustable Bolt	
15	113072	Tail Axle Bearing Assembly	
16	113041	Standard Main Axle Sprocket	
17	117018	Hose 3/8" x 27"	

Item No.	Part No.	Description	Price
18	GVB 3/4	3/4" Shut-off Valve	
19	113024	3/4" x 24" Suction Hose	
21	113090	Nose Axle Bearing Assembly	
22	113282	4-J Rubber Sleeve	
24	113228	Tee 1/2"	
25	113235	Close Nipple 1/2" Schedule 80	
	113265	Flex Coupling	
	113550	Hinge Replacement Kit	
	113199	Flat Head Orbit Nose Screw	
	60023	Seal Kit for Char-Lynn Series 7 Orbit Motor	
	60036	Seal Kit for Char-Lynn Series 5 Orbit Motor	
	60540	Seal Kit for Char-Lynn Series 9 Orbit Motor	
	4144	Chain A2050 Connecting Link	
	4153	Chain A2050 Offset Link	
	113040	Nose and Tail Axle Sprocket	
	113015	Orbit Motor P	
	113310	Complete Component Box	
	Tech MM	Motor Mount Conversion Plate for Tech Engine	
26	6HP-SAE-AA-2	6HP C Face Pump Mount	
26	8HP-SAE-AA-2	8HP C Face Pump Mount	
27	113046A	Bull Gear Assembly	

TWIN RAIL MOVER ASSEMBLY

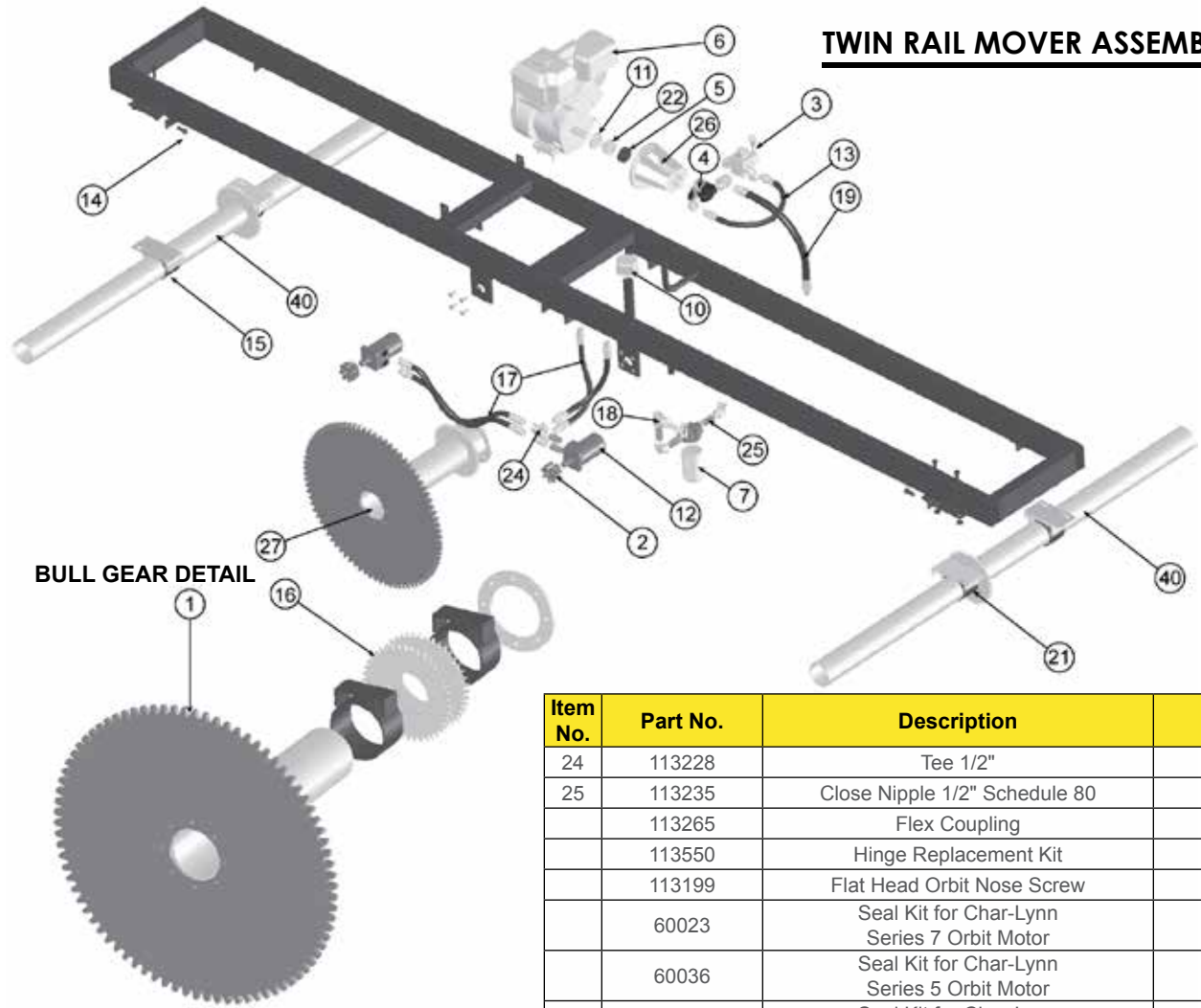

BULL GEAR DETAIL

Item No.	Part No.	Description	Price
1	113046	Bull Gear	
2	113044	Orbit Motor Gear	
3	113081	Hydraulic Control Valve Assembly	
3B	113010	Valve Only	
4	113083	Hydraulic Pump Assembly	
4B	113011	Pump Only	
5	113309	4-J Flange 1/2"	
6	113260	8 H.P. Engine	
7	113016	Canister Filter Assembly	
8	113266	Roller Chain #50 (not shown)	
9	113070	Axle w / Drive Sprocket	
10	113267	Breather Cap	
11	113308	4-J Flange 1"	
12	113013	Orbit Motor K	
13	113023	Discharge Hose 3/8" x 20"	
14	113186	Stringer Adjustable Bolt	
15	113072	Tail Axle Bearing Assembly	
16	113041	Standard Main Axle Sprocket	
17	117018	Hose 3/8" x 27"	
18	GVB 3/4	3/4" Shut-off Valve	
19	113024	3/4" x 24" Suction Hose	
21	113090	Nose Axle Bearing Assembly	
22	113282	4-J Rubber Sleeve	

Item No.	Part No.	Description	Price
24	113228	Tee 1/2"	
25	113235	Close Nipple 1/2" Schedule 80	
	113265	Flex Coupling	
	113550	Hinge Replacement Kit	
	113199	Flat Head Orbit Nose Screw	
	60023	Seal Kit for Char-Lynn Series 7 Orbit Motor	
	60036	Seal Kit for Char-Lynn Series 5 Orbit Motor	
	60540	Seal Kit for Char-Lynn Series 9 Orbit Motor	
	4144	Chain A2050 Connecting Link	
	4153	Chain A2050 Offset Link	
	113040	Nose and Tail Axle Sprocket	
	113015	Orbit Motor P	
	113310	Complete Component Box	
	Tech MM	Motor Mount Conversion Plate for Tech Engine	
26	6HP-SAE-AA-2	6HP C Face Pump Mount	
26	8HP-SAE-AA-2	8HP C Face Pump Mount	
27	113046A	Bull Gear Assembly	
	117016	Flat Filter	
	117016S	Flat Filter Screen	
	118023	3/8" x 20" Hose (connects pump to valve)	
	118024	3/4" x 18.5" Suction Hose	
	118002	Power Pack Assembly (includes engine and pump assembly)	
	118260	Vertical Engine Only (8HP)	
	118266	Chains A2050 (154 pitch)	
	118072	Axle Bearing Assembly Left (Hole is on left side of bent portion of the plate when looking at the bearing assembly with the bent side closest to you.)	
	118090	Axle Bearing Assembly Right (as above, only with the hole is on right side)	
40	118070	Axle with Drive Sprockets (Standard length 6'8")	

All parts are the same as the standard 12' A&M and Western Mover, except for the ones listed on this page.

INTRO | 1. ELECTRICAL | 2. PUMP ACC. | 3. HOSE, PE PIPE & ACC. | 4. FPS, PIP PIPE & ACC. | 5. SURFACE | 6. SPRINKLERS | 7. TRAVELER & WHEEL MOVE | 8. PIVOT | 9. TURF | 10. LOW VOLUME | 11. FILTERS | 12. INJECTION | 13. HARDWARE | INDEX

SECTION 8

Pivot Irrigation

CONTENTS

- 8:4 PIVOT PRINTOUT
- 8:5 PRESSURE GAUGES & ACCESSORIES
- 8:6 DRAINS, DROP VALVES & DROP FILTERS
- 8:7 HIGH CAPACITY FILTERS
- 8:8 UNDERSLING PVC PIPE & ACCESSORIES
- 8:9 BOOM BACKS
- 8:10 FURROW ARMS & GOOSENECKS
- 8:11 DROPS
- 8:12 FLEXIBLE DROP HOSE, PARTS & ACCESSORIES
- 8:13 HOSE DROP WEIGHTS
- 8:14 DROP & CONVERSION FITTINGS
- 8:15 FITTINGS & CLAMPS AND PRINTOUTS & PACKAGING
- 8:16-20 SENNINGER® PIVOT PRODUCTS
- 8:21 RAIN BIRD® PIVOT PRODUCTS
- 8:22-26 NELSON PIVOT PRODUCTS
- 8:27 PIVOT PRODUCTS
- 8:28 NELSON BIG GUN® SPRINKLERS
- 8:29 NELSON BIG GUN® NOZZLES
- 8:30 NELSON BIG GUN® NOZZLES & ACCESSORIES
- 8:31 AQUADOCK™
- 8:32-33 CONTROL VALVES
- 8:33 END GUN CONTROL VALVE
- 8:34 END GUN CONTROL VALVE ACCESSORIES
- 8:35 END GUN BOOSTER PUMP
- 8:35 PIVOT END GUN BOOSTER PUMP & ACCESSORIES
- 8:35-40 PIVOT DRIVE COMPONENTS
- 8:35 TELESCOPING DRIVELINE WITH COUPLER ENDS
- 8:36 UNIVERSAL DRIVELINE COUPLERS
- 8:36 UMC DRIVELINE COUPLERS
- 8:37 UMC FINAL DRIVE WHEEL GEARBOX
- 8:38 UMC TOWABLE HUB WITH PIN AND BRACKET ASSEMBLY
- 8:38 UMC REPLACEMENT PARTS
- 8:38 CENTER DRIVES & MOTORS
- 8:39 CENTER DRIVES & MOTORS
- 8:40 CENTER DRIVES & MOTORS
- 8:40 ELECTRICAL COMPONENTS & ACCESSORIES
- 8:41-42 FUSES
- 8:41 FLNR 250 VAC, FLQ 500 VAC & CCMR 600 VAC FUSES
- 8:42 FLSR 600 VAC ID FUSES
- 8:42 JTD 600 VAC ID BOLT-IN FUSES
- 8:42 GLASS BODY FUSES
- 8:43 TRANSFORMERS, SWITCHES & TIMERS
- 8:44 METER BASES, TERMINAL & JUNCTION BOXES
- 8:45 INSULATED BLOCKS
- 8:46 RELAYS
- 8:47 CONTACTORS
- 8:48 COLLECTOR RING AND ELECTRICAL ACCESSORIES
- 8:48 MISCELLANEOUS
- 8:49 WIRELESS AGRICULTURAL IRRIGATION MONITORING
- 8:50 STROBE LIGHTS
- 8:51 PIVOT BOOT HOSE & T-BOLT CLAMPS
- 8:52-57 TIRES, GALVANIZED WHEELS & ASSEMBLIES
- 8:52 TITAN® NEW TIRES, GALVANIZED WHEELS, TUBES AND ASSEMBLIES





Our printouts are known today as the #1 pivot printout in the country. Many of our customers have expressed their satisfaction with the ease of reading our printouts. When you order a custom engineered printout from us, you are getting a printout that has an unsurpassed background of knowledge. Our printouts have been in existence for nearly 35 years. Les Jochens was involved with pivot design back in 1949 at the beginning of the pivot industry. That was the first encounter in what has become a bank of extensive experience within our organization. We have CID accreditation by the Irrigation Association, specializing in Sprinkler and Center Pivot design, and we can provide CPED center pivot printouts when required by the USDA-NRCS. Our staff of engineers constantly monitor the ever-changing parameters of products and performance. We maintain our custom designed pivot printout software program to ensure that it not only has the most recent pivot products and data available, but also that it continues to be the most precise and informative printout that you can supply your customer. We have over 300 years of combined pivot design experience between our six companies. Our experience covers nearly every brand of pivot made in the industry, from the first to the most recent. We have spent hours upon hours out in the field hand measuring machines. We recheck manufacturers specifications and pay attention to all the small details that enable our pivot packages to perform to their maximum potential. When you order a printout from any of our 9 warehouse locations, you get not only experience, but we can also help you determine if the sprinkler type being used will be adequate for the existing field conditions that are given to us. We use original manufacturer information for sprinkler nozzle flow and pressure regulator outlet pressure. We calculate drop lengths to your specifications along with the associated friction loss and static head gain. We take the arch of the span into consideration when calculating pipe pressure. We can use multiple types of sprinklers, regulators and drop types in a single printout. We accurately size endgun nozzles even when multiple endguns of different types are used. If the specifications you give us won't work up to standards, we will call you, let you know what the problems are and help you find solutions. When you want a design that will be the best for you and your situation, call the people with the best printout and product knowledge!

EIS - Florida

ESCO (2) - Texas

SWISH - Texas

SWISH - Mississippi

WISH - Colorado

WISH - Nebraska

WISH-NW - Idaho

WISH-NW - Washington

LIQUID FILLED PRESSURE GAUGE

2-1/2" FACE, STAINLESS STEEL CASE

Part No.	PSI Range	Price
2141GXB15	0-15 PSI	
2141GXB30	0-30 PSI	
2141GXB60	0-60 PSI	
2141GXB100	0-100 PSI	
2141GXB160	0-160 PSI	
2141GXB300	0-300 PSI	

4" FACE, STAINLESS STEEL CASE

Part No.	PSI Range	Price
4141GXB30	0-30 PSI	
4141GXB60	0-60 PSI	
4141GXB100	0-100 PSI	
4141GXB160	0-160 PSI	

2-1/2" FACE, BLACK ABS PLASTIC CASE

Part No.	PSI Range	Price
LFS220-30	0-30 PSI	
LFS220-60	0-60 PSI	
LFS220-100	0-100 PSI	
LFS220-160	0-160 PSI	

4" FACE, BLACK ABS PLASTIC CASE

Part No.	PSI Range	Price
LFS310-30	0-30 PSI	
LFS310-60	0-60 PSI	
LFS310-100	0-100 PSI	
LFS310-160	0-160 PSI	

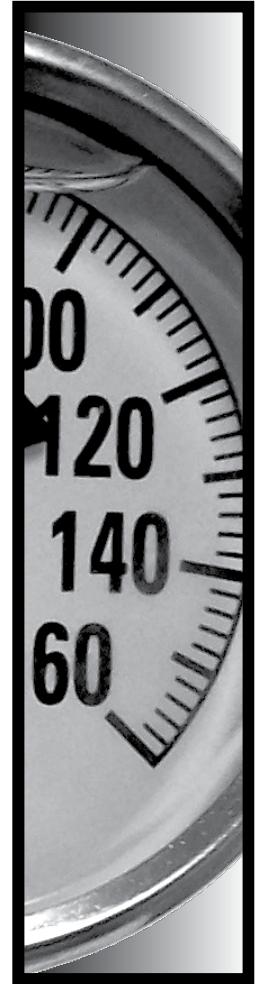

PRESSURE GAUGE ACCESSORIES

ACCESSORIES

Part No.	Description	Price
PIT25	Pitot Tube	
A90917	Pitot Tube	
A90952	Silcock Adapter	
12070006	Lock on Gauge Chuck 1/4" FIPT	
13180129	1/4" Schrader Valve	
12070010	Pocket Pressure Gauge 0-50 PSI	
9438-002	Fem. Quick Connect 1/4" FIPT	
9498	Male Quick Connect 1/4" FIPT	
EGA	End Gauge Assembly (Tee, Ell, Bushing, Nipple)	
PGW2430F	Polyweight® Gauge 24" 0-30 PSI	
PGW2460F	Polyweight® Gauge 24" 0-60 PSI	



NELSON SQUARE THREAD GAUGE ADAPTER

Part No.	Description	Price
10766	Square Thread Gauge Adapter (Pressure Gauge Not Included)	



INTRO 1. ELECTRICAL 2. PUMP Acc. 3. HOSE, PE PIPE & Acc. 4. FPS, PIP Pipe & Acc. 5. SURFACE 6. SPRINKLERS 7. TRAVELER & WHEEL MOVE 8. PIVOT 9. TURN 10. LOW VOLUME 11. FILTERS 12. INJECTION 13. HARDWARE INDEX

DRAINS

PIVOT - DRAIN

Part No.	Size	Description	Price
495-15	3/4"	Mushroom Pivot Drain Knobby Fast Drain	
495-25	3/4"	Mushroom Pivot Drain Plain Slow Drain	
Z-MD-LP	3/4"	Zimmatic Low Pressure Mushroom Drain	
1426430	3/4"	Zimmatic Z Drain - New Style	



PIVOT - DRAIN - Fast draining - automatic operation - corrosion & clog resistant

Part No.	Size	Description	Price
WSSD	1"	Zamac Poppet	
SDMBC-1	1"	Zamac Star	
SDPBC-1	1"	Zamac Star Drain with Plastic Base	
DRNSYS	1"	PVC Poppet	

DROP VALVES & END FLUSH KIT

PIVOT DROP VALVES - 3/4" FIPT X 3/4" MIPT

Part No.	Description	Features	Price
8-1000-0001	901 Orange Handle - Black Body	Quality	
422PL	Long Orange Handle - Black Body	Economical	
422P	Short Orange Handle - Black Body	Economical	
FTV3F3M	Blue Knob	Dial Knob	



SUPER FLUSH KIT

Hose Length	Hose Type	Matco Brass	Spears Pl. Single Entry	Banjo Pl. Std. Port	Banjo Pl. Full Port
8'	VINYLFLOW™				
8'	IRONSIDES™				
8'	CLEAR SUCTION				
8'	RUBBER				
9'	VINYLFLOW™				
9'	IRONSIDES™				
9'	CLEAR SUCTION				
9'	RUBBER				
10'	VINYLFLOW™				
10'	IRONSIDES™				
10'	CLEAR SUCTION				
10'	RUBBER				



The Super Flush Kit assembly is as simple as 1-2-3 for your pivot flush requirements.

- (1) select the hose length that best suits your needs.
- (2) select the type of hose that you want to use.
- (3) select the proper ball valve for your application.

The kit includes a galvanized 90° street ell, a galvanized king nipple, a plastic insert male adapter, 2 clamps, hose and ball valve.

Note: Other lengths are available upon request. Please specify length when placing order.

DROP FILTERS

3/4" AQUA-DROP FILTER -Threads into bottom of pivot drop for easy access.

Screen sized to reduce and / or prevent nozzles from clogging with debris.

Part No.	Description	Price
ADF075FF	3/4" Aqua-Drop Filter FIPT x FIPT	
ADF075FM	3/4" Aqua-Drop Filter FIPT x MIPT	
ADF075MF	3/4" Aqua-Drop Filter MIPT x FIPT	
ADF075MM	3/4" Aqua-Drop Filter MIPT x MIPT	



Screen Features:

- 20 mesh screen - 1/64" smaller than smallest nozzle available
- 5 inch screen increases surface area to reduce cleaning frequency
- 304 stainless steel screen for long life and rugged use
- Positive seal - gasket is molded into screen & sealed between fittings

3/4" EXCLUDER FILTER

Plug into the inlet side of the gooseneck prior to screwing gooseneck into pivot mainline. Developed to prevent debris from plugging nozzles.

Part No.	Size	Description	Price
EXC34	3/4"	Insert Filter for Galvanized Gooseneck	
EXC58	5/8"	Insert Filter for PVC Gooseneck	



EZ SCREENS

Part No.	Description	Price
EZ SQUARE	Square Grid Screen For 3TN Sizes #9-#31, UP3 Sizes #4-#15.5	
EZ BAR	Bar Grid Screen For 3TN Sizes #32-#50, UP3 Sizes #16-#26	



For Installation between span pipe and gooseneck, screens have single thread to screw into coupling or gooseneck on top of pipe. This location necessary for debris to clear during shutdown.

FRESNO FLOW GUARD GALVANIZED SCREEN 1500 SERIES

8"/1200 GPM WITH SCREEN

Part No.	Screen Size	Inlet	Outlet	Price
P3821-01	1/16"	Victaulic	Victaulic	
P3821-02	1/16"	Flange	Flange	
P3821-03	1/16"	Plain End	Plain End	
P3821-04	1/16"	Ringlock Male	Ringlock Bell	

Part No.	Screen Size	Inlet	Outlet	Price
P3821-21	3/32"	Victaulic	Victaulic	
P3821-22	3/32"	Flange	Flange	
P3821-23	3/32"	Plain End	Plain End	
P3821-24	3/32"	Ringlock Male	Ringlock Bell	

8"/1200 GPM WITH SCREEN CENTER FEED

Part No.	Screen Size	Inlet	Outlet	Price
P3821-47	3/32"	Victaulic	Victaulic	
P3821-48	3/32"	Flange	Flange	
P3821-49	3/32"	Plain End	Plain End	
P3821-50	3/32"	Ringlock Male	Ringlock Bell	

8"/1200 GPM WITH SCREEN CENTER FEED WITH LEGS

Part No.	Screen Size	Inlet	Outlet	Price
P0074-60	1/16"	Ringlock Male	Ringlock Bell	
P0073-82	3/32"	Ringlock Male	Ringlock Bell	

8"/1200 GPM WITH SCREEN CENTER FEED WITH OUT LEGS

Part No.	Screen Size	Inlet	Outlet	Price
P0074-60	1/16"	Ringlock Male	Ringlock Bell	
P0073-82	3/32"	Ringlock Male	Ringlock Bell	
P9093-02	Legs Kit With Bands			

8"/1750 GPM WITH SCREEN

Part No.	Screen Size	Inlet	Outlet	Price
P3850-01	1/16"	Victaulic	Victaulic	
P3850-02	1/16"	Flange	Flange	
P3850-03	1/16"	Plain End	Plain End	
P3850-04	1/16"	Ringlock Male	Ringlock Bell	

Part No.	Screen Size	Inlet	Outlet	Price
P3850-11	3/32"	Victaulic	Victaulic	
P3850-12	3/32"	Flange	Flange	
P3850-13	3/32"	Plain End	Plain End	
P3850-14	3/32"	Ringlock Male	Ringlock Bell	

CLEMONS PRESSURE FINE GALVANIZED FILTERS

HIGH FLOW STEEL FILTERS

Galvanized Body - Perforated Stainless Screen (1/32" - .031") - Plain End or Flange					
Part No.	GPM	Size	Weight Lbs.	Price Plain End	Price Flanged End
275A	275	4"	70		
475A	475	6"	120		
700A	700	8"	170		
1200A	1,200	8" - 10"	230		
2000A	2,000	12"	360		

Add an "F" to the part number for Flanged Ends
With 2" half coupler 1" drain coupler + 2 gauge ports.
Specify end feed or center feed.



24 Gauge Stainless Steel Screen
3/64" - .045" Protects pivots and other systems
3/32" - .094" Protects pivots and other systems
2000A Model Filter Available Only In .045" & .094" Perf (20 & 24 Ga in .094")

New 24 Gage Perforated Sizes
1/32" - .031" Protects pivots and other systems
1/8" - .125" Coarse system protection
1/4" - .250" Coarse system protection
*NEW 1200 Filter Only Available in 20ga 3/32"



Note: 1750 GPM filters use two screens each.

INTRO
 1. ELECTRICAL
 2. PUMP ACC.
 3. HOSE, PE PIPE & ACC.
 4. IPS, PIP PIPE & ACC.
 5. SURFACE
 6. SPRINKLERS
 7. TRAVELER & WHEEL MOVE
 8. PIVOT
 9. TURF
 10. LOW VOLUME
 11. FILTERS
 12. INJECTION
 13. HARDWARE
 INDEX

UNDERSLING PVC PIPE & ACCESSORIES

CONNECTIONS FROM PIVOT ELL TO PVC PIPE

Part No.	Connection from Pivot Ell to PVC Pipe	Price
SWE-45600	6" x 45° Black Steel Weld Elbow	
HOSEBEAD-6	6" Black Steel Weld-on Hose Bead	
T253AA600XFT	6" Rubber Discharge Hose	
95130-0650	T Bolt Clamp (6.25" - 6.65") (4 required)	
SGFLEHB-600-45	6" Flanged x Hose Barb 45° Ell, Galvanized	
12090023	VBK-1 Air and Vacuum Relief Valve	
FLG-GSKT-6 1/8	6" x 1/8" Red Rubber Gasket	
854-060	6" IPS Van Stone PVC Flange (If Using 6" IPS Pipe)	
354-060F	6" PIP Van Stone Flange (If Using 6" PIP Pipe)	
NBS3/4X3	3/4" x 3" Bolt Set	
Note: If 8" UV Pipe is used, use products from above table and the products listed below to convert to 8"		
32.602XFT	6-5/8" x 1 Ft. PVC PIPE - 160 PSI	
437-585	8" x 6" Sch. 40 Bushing Spig x Soc	
429-080	8" Sch. 40 Coupler - Soc	
431-080	8" Sch. 40 PIP x IPS Bushing (If Using 8" PIP Pipe)	
UV Resistant PVC PIPE	Call For Quote and Availability	



SUPPORT HANGERS

Part No.	Support Hangers for PVC Pipe	Price
HBGR-5-1-1/4	1/4" x 1" Bolt	
NLN1/4	1/4" Lock Nut	
10291-00145	Plumbers Tape 3/4" x 10' x 16 Gauge	
532GC7	5/32" Galvanized Aircraft Cable (5000')	
AS532	5/32" Aluminum Swage Sleeve (100PK)	

Note: For Additional Sizes of Cable, Wire Rope Clips and Aluminum Swage Sleeves Refer to Section 13



OUTLET ADAPTERS & ACCESSORIES

Part No.	Outlet Adapters and Holesaws	Price
TA-050	1/2" FIPT Vinyl Grommet Adapter (use HSA-100)	
TA-075	3/4" FIPT Vinyl Grommet Adapter (use HSA-1316)	
TA-100	1" FIPT Vinyl Grommet Adapter (use HSA-1716)	
HSA-100	1" Hole Saw with Arbor	
HSA-1316	1-3/16" Hole Saw with Arbor	
HSA-1716	1-7/16" Hole Saw with Arbor	
LA-OUT-ADAP	3/4" Barb x 3/4" Barb Outlet Adapter	
LA-OUT-CLP	Mainline Pipe Clamp	
12070071	Drill Bit for Saddles	
12080052	AS-3/4-4 3/4" Socket Bondable Saddle - 4" PVC Pipe	
12080054	AS-3/4-6 3/4" Socket Bondable Saddle - 6" PVC Pipe	
12080055	AS-3/4-8 3/4" Socket Bondable Saddle - 8" PVC Pipe	
461-007	3/4" Spig Adapter for Saddle x 3/4" MPT	
478-007	3/4" Spig Adapter for Saddle x 3/4" FPT	
460-007	3/4" Spig Adapter for Saddle x 3/4" Barb	

Note: 40 PSI Maximum for Vinyl Grommet Adapters and Bondable Saddles
Use Heavy Bodied Cement 719 or Equivalent for Bondable Saddle



HITCHCOCK ADJUSTABLE BOOM BACK

Extends nozzle behind main structure to help prevent deep wheel tracks.

- Lengths of 12 foot or 16 foot are available
- Can use any type of nozzles
- Different angle adjustment
- Easy installation
- Clamps to any size pipe
- Can be used on any type of system

Part No.	Description	Price
H-###	4", 5", 5-9/16", 6", 6-5/8", 8", 8-5/8"	

Specify Size, Price is for 12 Ft.

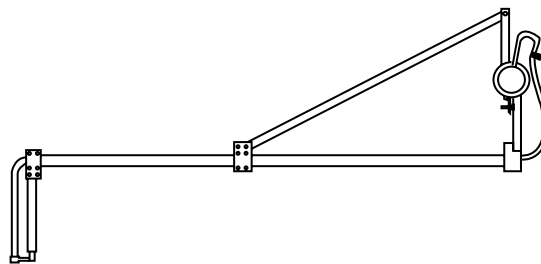

BOOM BACKS

Part No.	Description	Price
BB-4	4" Boom Back	
BB-5-9/16	5-9/16" Boom Back	
BB-6	6" Boom Back	
BB-6-5/8	6-5/8" Boom Back	
BB-8	8" Boom Back	
BB-8-5/8	8-5/8" Boom Back	

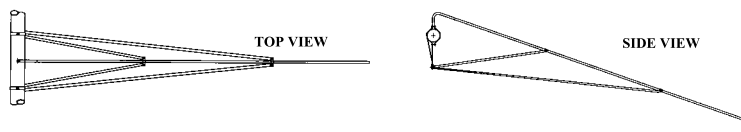

BULLY BOOM SUPPORT ASSEMBLY

Part No.	Description	Price
10BB36-BTS w/Sway	10' Boom Sch. 40, 36" Support	
15BB56-BTS w/Sway	15' Boom Sch. 40, 56" Support	
10BB30-BTS	10' Boom Sch. 40, 30" Support	
15BB56-BTS	15' Boom Sch. 40, 56" Support	

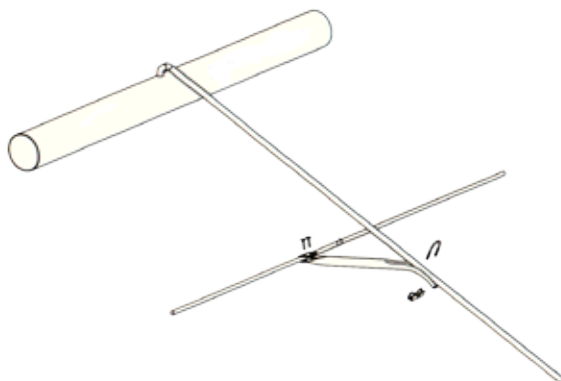

IACO IDAHO BOOM WITH BRACE

Part No.	Description	Price
MST-IOB-A##	10', 3" Through 6-5/8"	
MST-IOB-A##	10', 8" Through 10"	
MST-IOB-C##	15', 3" Through 6-5/8"	
MST-IOB-C##	15', 8" Through 10"	

IACO ALUMA BOOM WITH BRACE

Part No.	Description	Price
MAL-IOB-C15	5-9/16" x 15'	
MAL-IOB-C17	6-5/8" x 15'	
MAL-IOB-C18	8" x 15'	



IACO BOOM WITH BRACE

Part No.	Description	Price
MST-BBT-V20	10' Boom with Brace	

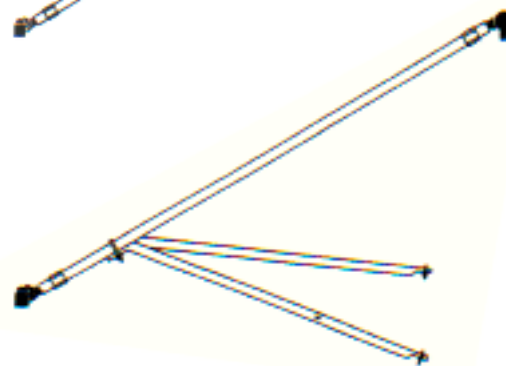

PIVOT CIRCLE STRETCHER

Part No.	Description	Price
CS-0500	5" Circle Stretcher	
CS-5916	5-9/16" Circle Stretcher	
CS-0600	6" Circle Stretcher	
CS-0658	6-5/8" Circle Stretcher	

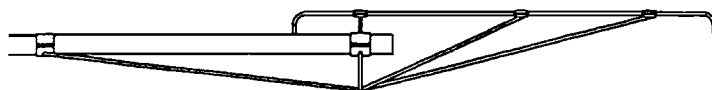

INTRO 1. ELECTRICAL 2. PUMP ACC. 3. HOSE, PE PIPE & ACC. 4. IPS, PIP PIPE & ACC. 5. SURFACE 6. SPRINKLERS 7. TRAVELER & WHEEL MOVE 8. PIVOT 9. TURN 10. LOW VOLUME 11. FILTERS 12. INJECTION 13. HARDWARE INDEX

FURROW ARMS & GOOSENECKS

FURROW ARMS

3/4" GALVANIZED FURROW ARMS

Part No.	Description	Price
FA12-MF	3/4" x 12" Furrow Arm Male x Female	
FA12-MM	3/4" x 12" Furrow Arm Male x Male	
FA12-MB	3/4" x 12" Furrow Arm Male x Barb	
FA20-MF	3/4" x 20" Furrow Arm Male x Female	
FA20-MM	3/4" x 20" Furrow Arm Male x Male	
FA20-MB	3/4" x 20" Furrow Arm Male x Barb	



GOOSENECKS

3/4" GALVANIZED GOOSENECKS

Part No.	Description	Price
WS-MXF	3/4" x 6" Male x Female	
WS-MXM	3/4" x 6" Male x Male	
WS-MXB	3/4" x 6" Male x Barb	
WS-8MXF	3/4" x 8" Male x Female (T-L)	



3/4" ALUMINUM GOOSENECKS

Part No.	Description	Price
MEL-152-18A	3/4" x 6" Male x Female	
MEL-21B-18A	3/4" x 6" Male x Barb	



PLASTIC GOOSENECKS

3/4" SCH. 80 UV PVC VANMAR GOOSENECKS W/SS INSERT

Part No.	Description	Price
VM-MXF	3/4" x 6" Male x Female	
VM-MXM	3/4" x 6" Male x Male	
VM-MXB	3/4" x 6" Male x Barb	
VM-12MXB	3/4" x 12" Male x Barb Furrow Arm	



SENNINGER® GOOSENECKS & TRUSS ROD HOSE SLING

Part No.	Description	Price
GNAP180X6M	3/4" x 6" 180° Male x Male Plastic	
GNAP180X6B	3/4" x 6" 180° Male x Barb Plastic	
GN180X6M	3/4" x 6" 180° Female x Male	
GN180X6B	3/4" x 6" 180° Female x Barb	
GN180X6BI	3/4" x 6" 180° Female x 19MM Barb	
GN125DM	3/4" 125° Female x Double Male Plastic	
GN125DB	3/4" 125° Female x Double Barb Plastic	
GNAP125DM	3/4" 125° Male x Double Male Plastic	
GNAP125DB	3/4" 125° Male x Double Barb Plastic	
GN125SM	3/4" 125° Female x Single Male Plastic	
GN125SB	3/4" 125° Female x Single Barb Plastic	
GNAP125SM	3/4" x 125° Male x Single Male Plastic	
GNAP125SB	3/4" x 125° Male x Single Barb Plastic	



Part No.	Description	Price
TRHS-625	Truss Rod Hose Sling, for 5/8" Rod (Rust)	
TRHS-687	Truss Rod Hose Sling, for 11/16" Rod (Green)	
TRHS-750	Truss Rod Hose Sling, for 3/4" Rod (Black)	
TRHS-812	Truss Rod Hose Sling, for 13/16" Rod (Gray)	
TRHS-875	Truss Rod Hose Sling, for 7/8" Rod (Blue)	
TRSGA	Truss Rod Sizing Gauge (Aluminum)	
FTN33D	3/4" x Close Delrin Nipple	
GVN3020	3/4" x 2" Galvanized Steel Nipple	

DROPS - READY TO INSTALL

Our Polydrop® was the first successful plastic drop used for center pivot irrigation. It is still the most widely used drop of its type in the industry. Our Polydrop® is different from any other polyethylene drop used today. It is the #1 drop preferred by dealers, installers, & growers. This drop has been in the field for over 25 years. Our drops have been problem-free. Due to its unmatched & unsurpassed problem free track record, make sure that when you order a polyethylene drop it is the true and original Polydrop®. Don't accept any look-alikes.

3/4" SEMI-RIGID PIVOT POLYDROPS®

Part No.	Size	Price
PD-012	12"	
PD-018	18"	
PD-024	24"	
PD-030	30"	
PD-036	36"	
PD-042	42"	
PD-048	48"	
PD-054	54"	
PD-060	60"	
PD-066	66"	
PD-072	72"	
PD-078	78"	
PD-084	84"	
PD-090	90"	
PD-096	96"	
PD-102	102"	
PD-108	108"	
PD-114	114"	
PD-120	120"	
PD-126	126"	
PD-132	132"	
PD-138	138"	
PD-144	144"	
PD-150	150"	
PD-156	156"	
PD-162	162"	
PD-168	168"	
PD-174	174"	
PD-180	180"	

Specify Ends: Steel MIPT, Plastic MIPT, FIPT or Barb

3/4" VANMAR SCH. 80 PVC DROPS

Part No.	Size	Price
VM-024	24"	
VM-030	30"	
VM-036	36"	
VM-042	42"	
VM-048	48"	
VM-054	54"	
VM-060	60"	
VM-066	66"	
VM-072	72"	
VM-078	78"	
VM-084	84"	
VM-090	90"	
VM-096	96"	
VM-102	102"	
VM-108	108"	
VM-114	114"	
VM-120	120"	

Available Male x Male only.

3/4" POLYDROP® W/ 2' OF FLEXIBLE DROP HOSE

Designed for Senninger I-WOB® Systems

Part No.	Size	Bottom Connection	
		Blank	Male
PF-024	24"		
PF-030	30"		
PF-036	36"		
PF-042	42"		
PF-048	48"		
PF-054	54"		
PF-060	60"		
PF-066	66"		
PF-072	72"		
PF-078	78"		
PF-084	84"		
PF-090	90"		
PF-096	96"		
PF-102	102"		
PF-108	108"		
PF-114	114"		
PF-120	120"		
PF-126	126"		
PF-132	132"		
PF-138	138"		
PF-144	144"		
PF-150	150"		
PF-156	156"		
PF-162	162"		

HOSE EXTENSIONS

Part No.	Size	Price
FLEX-18	18"	
FLEX-24	24"	

Male x Female standard - Other ends please specify.

HOSE SAVER POLYDROP®

Part No.	Description	Price
PD084MB	7' Polydrop® sm x pb	
PD096MB	8' Polydrop® sm x pb	
PD108MB	9' Polydrop® sm x pb	

Other sizes available.

Choice of Fittings:

- 3/4" FIPT Plastic inlet fitting for plastic goosenecks
- 3/4" MIPT Plated steel inlet fitting for galvanized goosenecks
- 3/4" Plastic barb outlet fitting for quick hose connection

Stop the aggravation of premature hose failure and drop loss immediately below the gooseneck with the Hose Saver

- Eliminates hose failure and breakage at the gooseneck
- Extends hose life and maximizes hose investment
- Eliminates product loss and replacement expense
- Eliminates expensive down time and labor expenses

By improving the integrity of the drop package, many other things are allowed to happen that has a positive effect on the system and the bottom line at harvest time.

- Maintain sprinkler pattern & water distribution uniformity
- Eliminate plant stress as a result of improper irrigation due to drop loss
- Eliminate plant damage and crop loss due to missing drops
- Increase yield potential due to maximizing system efficiency

3/4" GALVANIZED DROPS

Part No.	Size	Price
G-018	18"	
G-024	24"	
G-030	30"	
G-036	36"	
G-042	42"	
G-048	48"	
G-054	54"	
G-060	60"	
G-066	66"	
G-072	72"	
G-078	78"	
G-084	84"	
G-090	90"	
G-096	96"	
G-102	102"	
G-108	108"	
G-114	114"	
G-120	120"	
G-180	180"	

Available Male x Male only.

1. ELECTRICAL 2. PUMP ACC. 3. HOSE, PE PIPE & ACC. 4. IPS, PIP PIPE & ACC. 5. SURFACE 6. SPRINKLERS 7. TRAVELER & WHEEL MOVE 8. PIVOT 9. TURF 10. LOW VOLUME 11. FILTERS 12. INJECTION 13. HARDWARE INDEX

3/4" X 250' FLEXIBLE DROP HOSE

We are pleased to offer seven quality hoses for your drop hose selection. Included in those are Senninger®, Gilmour Premium and Premium Plus, Parker Black, Blue and Red Premium as well as Goodyear® Sureline®. With an offering of this magnitude we are able to provide you with the highest quality hose that our industry has to offer. Considering both product requirements and economic limitations we have a hose type that is sure to fit every need and satisfy every customer. Since 1987 we have been distributing pivot drop hose. We understand the importance and necessity of supplying a quality cost-effective product to meet or exceed the most demanding applications. Please let us know if we can assist you in determining the right selection for your customer.

Senninger®: A solid PVC inner core tube which results in a more kink resistant hose. Highly durable PVC cover which provides excellent weathering ability & maximum resistance to ultraviolet damage. Polyester spiral wound reinforcement yarns between the PVC jacket and the inner core. Medium burst strength.

Quality: GOOD

Gilmour Premium: A co-extruded liner which has a solid thin inner wall & a thicker foam wall, providing for lighter weight & a more flexible product. Highly durable PVC cover which provides excellent weathering ability & maximum resistance to ultraviolet degradation. A knitted synthetic cord reinforcement between the PVC jacket & the inner core. Medium burst strength.

Quality: GOOD

Parker Black: Solid PVC inner core with a black PVC jacket which provides excellent weathering ability and a maximum resistance to ultraviolet damage. Reinforced with spiral wound polyester yarns between the PVC jacket and inner core. More environmentally friendly when compared to rubber as well as lighter in weight. Medium to high burst strength.

Quality: GOOD

Gilmour Premium Plus: A solid co-extruded liner which results in a product which is heavier & more kink resistant. Highly durable PVC cover which provides excellent weathering ability and maximum resistance to ultraviolet damage. A knitted synthetic cord reinforcement between the PVC jacket & the inner core. Medium to high burst strength.

Quality: BETTER

Parker Red / Blue Premium: Solid Black PVC inner core with a colored PVC jacket which provides excellent weathering ability and a maximum resistance to ultraviolet damage. Reinforced with spiral wound polyester yarns between the PVC jacket and inner core. More environmentally friendly when compared to rubber. Lighter in weight. Medium to high burst strength.

Quality: BETTER

Goodyear® Sureline®: A heavy duty solid extruded Versigard® synthetic rubber core wrapped with a spiral reinforced synthetic yarn. Covered with a black Versigard® extruded seamless jacket. Extremely kink resistant. High burst strength.

Quality: BEST

BLACK FLEXIBLE DROP HOSE

Brand	Description	Price
Senninger®	3/4" x 250' Flex Hose	
Gilmour Premium	3/4" x 250' Flex Hose	
Gilmour Premium Plus	3/4" x 250' Flex Hose	
Goodyear® Sureline®	3/4" x 250' Flex Hose	
Parker Premium	3/4" x 250' Flex Hose	



Ask us about random length drop hose at reduced prices.

BLUE AND RED COLORED DROP HOSE

Brand	Part No.	Length	I.D.	Price
Parker Blue Premium	120-12046250	250'	3/4"	
Parker Red Premium	120-12044250	250'	3/4"	

Parker Colored Drop Hose includes 10 year pro-rated warranty.



DRAGBULLET

Dragbullet: A weighted device used to keep a 180° spray upright while being dragged behind a center pivot on each side of each tower to help reduce wheel tracking.

DRAGBULLET

Part No.	Description	Price
DRAGBULLET	Dragbullet	



POLYWEIGHTS®

POLYWEIGHT® - PLASTIC DROP WEIGHTS NOTCHED & ROUNDED SLEEVE

Part No.	Length	Weight Lbs.	Price
PW-026	26"	2.00	
PW-024	24"	2.00	
PW-021	21"	1.75	
PW-018	18"	1.50	
PW-015	15"	1.25	
PW-009	9"	.75	

POLYWEIGHT® - PLASTIC DROP WEIGHTS ROUNDED & THREADED FIPT X BARB

Part No.	Length	Weight Lbs.	Price
PW-024-FXB	24"	2.00	
PW-021-FXB	21"	1.75	
PW-018-FXB	18"	1.50	
PW-015-FXB	15"	1.25	
PW-009-FXB	9"	.75	

POLYWEIGHT® - PLASTIC DROP WEIGHTS ROUNDED & THREADED MIPT X BARB

Part No.	Length	Weight Lbs.	Price
PW-024-MXB	24"	2.00	
PW-021-MXB	21"	1.75	
PW-018-MXB	18"	1.50	
PW-015-MXB	15"	1.25	
PW-009-MXB	9"	.75	

SCH. 40 GALVANIZED STEEL WEIGHT

3/4" MIPT X BARB

Part No.	Length	Weight Lbs.	Price
WT-24-MXB	24"	2.00	
WT-18-MXB	18"	1.50	
WT-15-MXB	15"	1.25	

1" NOTCHED SLEEVE

Part No.	Length	Weight Lbs.	Price
WT-24-NS	24"	3.20	
WT-18-NS	18"	2.40	
WT-15-NS	15"	2.00	

1" NO NOTCH SLEEVE

Part No.	Length	Weight Lbs.	Price
WT-18-NNS	18"	2.40	
WT-15-NNS	15"	2.00	



APPLICATOR WEIGHTS

SENNINGER® ONE WEIGHT

Provides stability on drops for a number of pivot applicators. Unique "fit technology" allows the weight to fit securely on all Senninger applicators used on flexible drops and even some other manufacturer's applicators. Constructed entirely of zinc alloy for strength and resistance to corrosion.

Part No.	Weight Lbs.	Price
ONEWGT4	.85 Lb. Threaded	



NELSON 3000 SERIES DROP WEIGHT

Part No.	Weight Lbs.	Price
10130	1 Lb. Modular Drop Weight	



INTRO
1. ELECTRICAL
2. PUMP ACC.
3. HOSE, PE PIPE & ACC.
4. IPS, PIP PIPE & ACC.
5. SURFACE
6. SPRINKLERS
7. TRAVELER & WHEEL MOVE
8. PIVOT
9. TURF
10. LOW VOLUME
11. FILTERS
12. INJECTION
13. HARDWARE
INDEX

DROP & CONVERSION FITTINGS

SENNINGER® PLASTIC FITTINGS

Part No.	Description	Price
FTA3F3B	3/4" FIPT x Barb Adapter	
FTA3M3B	3/4" MIPT x Barb Adapter	
FTA3B3B	3/4" Barb Coupling	
FTP3	3/4" MIPT Plug	
FTN32	3/4" MIPT x 1/2" MIPT Reducing Nipple	
FTN33D	3/4" MIPT x Close Nipple	
CPL22	1/2" FIPT Coupling	
CPL33	3/4" FIPT Coupling	
CPL44	1" FIPT Coupling	
CPL55	1-1/4" FIPT Coupling	
CPL32	3/4" x 1/2" FIPT Reducer Coupling	
CPL43	1" x 3/4" FIPT Reducer Coupling	
CPL54	1-1/4" x 1" FIPT Reducer Coupling	
CPL53	1-1/4" x 3/4" FIPT Reducer Coupling	
FTB43	1" x 3/4" Threaded Reducer Bushing	



NELSON PLASTIC FITTINGS

Part No.	Description	Price
10057	3/4" Hose Barb x FIPT Adapter	
10148	3/4" Hose Barb x MIPT Adapter	
9901	3/4" Hose Barb x 3000 Adapter	



SPEARS PLASTIC FITTINGS

Part No.	Description	Price
M412-007	3/4" Marlex Street Ell	
805-007	3/4" Sch. 80 Threaded Tee	
883-005	3/4" x Close Sch. 80 Nipple	
883-020	3/4" x 2" Sch. 80 Nipple	
883-060	3/4" x 6" Sch. 80 Nipple	
883-120	3/4" x 12" Sch. 80 Nipple	
1435-007	3/4" FIPT x Insert Adapter	
1436-007	3/4" MIPT x Insert Adapter	
1429-007	3/4" Insert Coupling	
1403-007	3/4" Insert x Insert x MIPT Tee	
1413-007	3/4" Insert x MIPT 90° Ell	



GALVANIZED FITTINGS

Part No.	Description	Price
ZNG052	1" x 2" Nipple	
ZNG0412	3/4" x 12" Nipple	
ZNG042	3/4" x 2" Nipple	
ZNG044	3/4" x 4" Nipple	
ZMGPL05	1" MIPT Plug	
ZMGPL04	3/4" MIPT Plug	
M-CG04	3/4" FIPT Coupling	
M-CG05	1" FIPT Coupling	
M-CG06	1-1/4" FIPT Coupling	
ZMG CPR0403	3/4" x 1/2" FIPT Reducer Coupling	
ZMG CPR0504	1" x 3/4" FIPT Reducer Coupling	
ZMG CPR0605	1-1/4" x 1" FIPT Reducer Coupling	
ZMG CPR0604	1-1/4" x 3/4" FIPT Reducer Coupling	
ZMG BU0504	1" x 3/4" Threaded Reducer Bushing	
ZMG BU0604	1-1/4" x 3/4" Thrd. Reducer Bushing	
ZMGT04	3/4" Tee	
ZMGT05	1" Tee	



Note: Additional Galvanized & Black Steel Fittings & Nipples Located in Section 2

STANDARD MERCHANT COUPLER

Size	Black Full Part No.	Price	Black Half Part No.	Price
3/4"	M-CB04		M-HCB04	
1"	M-CB05		M-HCB05	
2"	M-CB08		M-HCB08	



ALUMINUM HALF COUPLER

Part No.	Size	Weight Lbs.	Price
HC075	3/4"	.25	
HC100	1"	.32	
HC200	2"	1	



CLAMPS & TOOLS

Part No.	Description	Price
15500016	271R 3/4" Pinch Clamp for 3/4" Drop Hose	
15500018	301R 3/4" Pinch Clamp for Sureline® Hose	
15500020	331R 1" Pinch Clamp for Polydrop®	
H1000C	H10 3/4" Gear Clamp for Drop Hose	
H1200C	H12 3/4" Gear Clamp for Sureline® Hose	
14100082	Standard Handle Pinch Clamp Tool	
14100084	Long Handle Pinch Clamp Tool	
T135YSS	1.625" OD Kwikcut Cutter with Stainless Blade	
T100YSS	1.25" OD Kwikcut Cutter with Stainless Blade	



PIVOT PRINTOUT, NOZZLING, LABELING AND PACKAGING

Below are some production charges which are associated with producing the #1 Pivot Design Printout in the Country, and for nozzling, labeling and packaging heads for the system. Please contact us to confirm these prices, as actual charges may vary a little depending on regional procedure within each of our warehouse service areas.

PRINTOUT CHARGES

Part No.	Description	Price
NPO	New Printout Only	
NPCP	New Printout with Complete Package	
NPSAN	New Printout - Supply All Nozzles	
NPND0	New Printout - Nozzle Difference Only	
REPO	Redo Existing Printout Only	
REPSAN	Redo Existing Printout - Supply All Nozzles	
REPND0	Redo Existing Printout - Nozzle Difference Only	



NOZZLING, LABELING AND PACKAGING CHARGES

Part No.	Description	Price
NLPNS	Nelson Sprays	
NLPSS	Senninger® Sprays	
NLPRANTS	Nelson Rotators®, Accelerators, Nutators, Trashbusters and Spinners	
NLPWQ	Senninger Wobblers® and Quad Sprays®	
NLP SAN	String all Nozzles in Sequence	
NLPIS	Impact Sprinklers	



SENNINGER® pioneered pivot regulators and makes a wide range of pivot regulators with multiple flow & pressure combinations. Excellent quality & durability. The PSR-2 is the future of Senninger Regulators, with this new technology the PSR-2 is able to pass debris more easily leading to less plugging and higher uniformity in the field.

SENNINGER® PRESSURE REGULATORS

Part No.	Description	Flow Range (GPM)	Price
PRL-##	3/4" FIPT Low Flow	1/2 - 5 & 1/10 - 8	
PMR-##MF	3/4" FIPT Medium Flow	4 - 16 & 2 - 20	
PSR-##	3/4" FIPT All Flow	1/2 - 15	
PSR2-##	3/4" FIPT All Flow Dirt Water	1/2 - 15	
PR-##HF	1-1/4" FIPT x 1" FIPT High Flow	10 - 32	



- 6, 10, 12, 15, 20, 25, 30, 35, 40, 50 PSI Note: PSR2 regulators ideal for dirty water

SENNINGER® UP3™ PRODUCTS

Senninger's exclusive UP3™ (Universal Pivot Products Platform) product line adds significant benefits to the proven technologies of the i-Wob, Xi-Wob, LDN and Super Spray.

Easy-Clean / Easy-Change Nozzle Design

Just pinch and pull to remove the nozzle; place and click to re-install. Cleaning and changing nozzles is so convenient—no need to disassemble or remove the sprinkler. The UP3 nozzle sizes are easily identifiable with color-coding and embossing on the ears, including half sizes (orifice diameters in 128th inch increments). This same nozzle is universal to the i-Wob, Xi-Wob, LDN and Super Spray sprinklers.



Integrated Base and Bracket

Each applicator can be installed directly into a pressure regulator or onto a standard 3/4" NPT female connection with no special threads or fittings required. This increases reliability and means fewer parts are required.

Dual Nozzle Carrier (patent pending)

Utilizing two different flow rates in a center pivot (a lower rate for germination or chemigation and a higher rate for mature crop irrigation) provides an excellent way to save water and energy. The Dual Nozzle Carrier greatly simplifies renozzling for this purpose. Simply - pinch and pull the nozzle from the applicator; flip the carrier; then place and click to install the second nozzle into place. The carrier is marked to show the high and low flow nozzles. The flexible material provides the ability for in-canopy operation and improves durability from possible impact.



UP3™ - SUPER SPRAY®

Field-proven for more than 30 years, the Senninger Super Spray provides more versatility than any other spray nozzle on the market. It offers a wide variety of interchangeable deflector pad options to meet specific crop, climatic and soil requirements. The design makes it ideal for surface water due to the large distance between the nozzle and deflector and the bracket legs.

Part No.	Description	Price
SSBRASM-UP3	3/4" 360° Super Spray UP3 Bracket	
Note: Pads are available in 1) Smooth, 2) 36 medium groove, 3) 24, 36, or 48 deep groove.		
SSPFL-XXXX	Flat Plates (Black)	
SSPCC-XXXX	Concave Plates (Blue)	
SSPCV-XXXX	Convex Plates (Green)	



SENNINGER® UP3™ PRODUCTS

UP3™ LDN® LOW DRIFT NOZZLE

Introduced in 1990 the Senninger LDN® was the first spray nozzle with multiple deflector pads. This produces uniform sized droplets through the wide range of nozzle flows found on center pivots. The result is extremely efficient water application with minimized losses to wind-drift, evaporation and run-off.

Part No.	Description	Price
LDNBRASM-UP3	3/4" LDN UP3 Bracket Base	
LDNPHDF	Flat Deflector Pad (Black)	
LDNPHDC	Concave Deflector Pad (Blue)	
LDNPHDV	Convex Deflector Pad (Green)	
LDNPHDPC	Part Circle Deflector Pad (CC17DG)	

UP3™ SPECIALTY LDN PARTS

Part No.	Description	Price
LDNHHDHA3	UP3™ LDN Hose Drag Adapter	
LDNPHXXB	UP3™ LDN Bubbler Pad	
LDNSBS-UP3	UP3™ LDN Shroud Spacer Only (used when one weight is not used)	
LDNS-UP3	UP3™ LDN Shroud	

UP3™ i-WOB™

Senninger introduced "Wobbler technology" in 1980. Its unique rotary action combined with its groove geometry delivers a consistent droplet size and outstanding uniformity over a large area of coverage. This design offers distinct benefits in preventing wind drift and providing a gentle, rain-like application of water to the soil. The i-Wob doesn't dissolve soil clods or seal over the soil like other products.

Part No.	Description	Price
IWOB00B3SA9-UP3	3/4" i-WOB UP3 Standard Angle 9 Groove (Black)	
IWOB00B3SA6-UP3	3/4" i-WOB UP3 Standard Angle 6 Groove (Grey)	
IWOB00B3LA9-UP3	3/4" i-WOB UP3 Low Angle 9 Groove (Blue)	
IWOB00B3LA6-UP3	3/4" i-WOB UP3 Low Angle 6 Groove (White)	
ONEWT4	The One Weight 0.85 LBS.	

UP3™ Xi-WOB®

The Senninger Xi-Wob provides the same ultra-low application intensity that has made the Senninger i-Wob™ the leading pivot sprinkler on the market. The Xi-Wob uses patented counter-balance technology which makes it ideal for installation on semi-rigid PE and steel drops.

Part No.	Description	Price
XIWOB00B3910UP3	3/4" Xi-WOB UP3 10° Low Angle 9 Groove (Grey)	
XIWOB00B3615UP3	3/4" Xi-WOB UP3 15° High Angle 6 Groove (Black)	
XIWOB00B3610UP3	3/4" Xi-WOB UP3 10° Low Angle 6 Groove (Blue)	
XIWOB00B3605UP3	3/4" Xi-WOB UP3 5° Low Angle 6 Groove up top (White)	

Senninger's Xi-Wob 605-TOP UP3 literally turns the popular Xi-Wob upside down. It is ideal for reducing over-watering by allowing wide spacing (up to 20 feet, 6.1 meter) and providing a wind-resistant pattern with extremely uniform coverage. The Xi-Wob 605-TOP UP3 is a low pressure, 10 psi (0.69 bar) sprinkler, that is mounted on the top of the pipe along the length of a center pivot or any other mechanical-moving system.

LEPA QUAD-SPRAY®

Part No.	Description	Price
LPAR06	3/4" FIPT Lepa Quad-Spray Complete (Includes 6 PSI Regulator)	
LPAR10	3/4" FIPT Lepa Quad-Spray Complete (Includes 10 PSI Regulator)	
LPAN	3/4" FIPT Lepa Quad-Spray Complete (Less Regulator, w/Spacer)	



INTRO
1. ELECTRICAL
2. PUMP, ACC.
3. HOSE, PE PIPE & ACC.
4. IPS, PIP PIPE & ACC.
5. SURFACE
6. SPRINKLERS
7. TRAVELER & WHEEL MOVE
8. PIVOT
9. TURF
10. LOW VOLUME
11. FILTERS
12. INJECTION
13. HARDWARE
INDEX

SENNINGER SUPER SPRAY®

The Super Spray is Senninger's most versatile spray nozzle. A wide selection of interchangeable snap-in deflector pads are available to address irrigation and chemigation requirements over a variety of crop, climatic and soil conditions. Pads available in 1) Smooth, 2) 36 medium groove, 3) 24, 36 & 48 deep groove. All types of pads available in either concave, flat or convex. Forty-five sizes of color coded nozzles are available to use at a suggested pressure range of 6-30 PSI.

Part No.	Description	Price
SUPERSPRAY	Complete Assembly with Nozzle & Plate	
SSBW1	Super Spray Bracket (Body)	
SSNZ-XX	Super Spray Nozzle (SSNZ04-SSNZ26)	
SSPFL-XXXX	Flat Plates (Black)	
SSPCC-XXXX	Concave Plates (Blue)	
SSPCV-XXXX	Convex Plates (Green)	



SENNINGER LDN® LOW DRIFT NOZZLE

Based upon nozzle size and flow, the LDN is designed to shear off water from the nozzle stream and direct it onto multiple levels of deflector pads, thereby controlling stream placement off the pad and droplet size. Also can be used as a single pad spray for maximum throw & droplet size off the pad. Circular design for minimum drag in crop. Pads available in 1) 24 mini and 2) 24 & 33 groove. All types of pads available in either concave, flat and/or convex. Operates best at 6-10 PSI. Multiple irrigation & chemigation pads to select from.

Part No.	Description	Price
LDN-SINGLE	Complete Spray w/Single Pad - Less Weight	
LDN-DOUBLE	Complete Spray w/Double Pad - Less Weight	
LDN-TRIPLE	Complete Spray w/Triple Pad - Less Weight	
LDN-PARTCIRCLE	Complete Part Circle Spray	
ONEWGT4	THE ONE Weight 0.85 LBS.	
LDNB	LDN 3/4" MPT Base	
LDNBB3	LDN 3/4" Barbed Base	
LDNHDC	LDN Cage	
SSNZ-XX	LDN Nozzle (SSNZ05 - SSNZ24)	
LDNPHDCXX	Concave Deflector Pads (Blue)	
LDNPHDFXX	Flat Deflector Pads (Black)	
LDNPHDVXX	Convex Deflector Pads (Green)	
LDNPHDPC-CDG17	Part Circle Deflector Pads	



SPECIALTY LDN® PADS

Part No.	Description	Price
LDNHDBUR	Bubble Ring	
LDNPHDB	Bubble Pad	
LDNHDBA3	Hose Drag Adapter	
LDNPHDCM	Corn Chemigation Pad	
LDNPHDCT	Cotton Chemigation Pad	



i-WOB®

Part No.	Description	Price
i-WOB-SA-9G	Inverted 360° Standard Angle 9 Groove (Black Deflector) w/out Weight	
i-WOB-LA-9G	Inverted 360° Low Angle 9 Groove (Blue Deflector) w/out Weight	
i-WOB-LA-6G	Inverted 360° Low Angle 6 Groove (White Deflector) w/out Weight	
ONEWGT4	The One Weight 0.85 LBS.	
IWB3-W	3/4" MNPT Base	
IWBB3	3/4" Barbed Base	
IWNZXX	Nozzle, Color Coded (IWNZ06-IWNZ24; Include Half Sizes)	
IWNZC	I-WOB Nozzle Carrier	
IWNZCD	I-WOB Dual Nozzle Carrier	
IWDHA3	I-WOB Hose Drag Adapter	



Specify 3/4" Male (NPT) Base or 3/4" Barbed Base. 9 Groove Deflector: Nozzle (Sizes #6-24)
6 Grooved Deflector: Nozzle (Sizes #12 -24) Must be installed with a minimum hose length of 2' at bottom of drop.

Xi-WOB®

Part No.	Description	Price
Xi-WOB-610	6 Groove 10° Trajectory Blue - for use with #7 - #24	
Xi-WOB-910	9 Groove 10° Trajectory Gray - for use with #10 - #24	
Xi-WOB-615	6 Groove 15° Trajectory Black - for use with #10 - #24	
IWNZXX	Nozzle, Color Coded (IWNZ06-IWNZ24; Include Half Sizes)	
IWB3-W	3/4" MNPT Base	
IWBB3	3/4" Barbed Base	

Specify 3/4" Male (NPT) Base or 3/4" Barbed Base.
 Designed for use on a rigid drop without hose.
 Optimal pressure range from 10 to 15 PSI.



WOBLER® FOR UPRIGHT INSTALLATION

Part No.	Description	Price
WOB-SA-3/4" M	3/4" MIPT, Standard Angle, Black Deflector	
WOB-LA-3/4" M	3/4" MIPT, Low Angle, White Deflector	

Must be installed on drop with WOB-LOOP.



XCEL WOBLER® FOR UPRIGHT INSTALLATION

Senninger's Xcel-Wobler is ideal for reducing over watering by allowing wide spacing (up to 20 feet) and providing a wind-resistant pattern with extremely uniform coverage. The Xcel-Wobler is a low pressure 10 psi sprinkler. It is mounted on the top of the pipe along the first two spans of a center pivot or other mechanical-move system.

Part No.	Description	Price
XCEL HA-3/4" M	3/4" MIPT, High Angle, Black Deflector	
XCEL MA-3/4" M	3/4" MIPT, Mid Angle, White Deflector	

- Mid Angle Apx 18° • High Angle Apx 24° • Nozzle Sizes Available # 6-14



FAN SPRAY™

Part No.	Description	Price
FANSPRAY	Part Circle Fan Spray 3/4"MIPT Base, Nozzle (Sizes #5-24)	



END SPRAY®

The low pressure End Spray is an excellent device to distribute flush water at the end of a machine. It can also be used to balance the close-in areas under end guns. The low-angle design combats the effects of wind and the large orifice resists clogging.

Part No.	Description	Price
ENDSPRAY	1" MNPT, 180° Distribution	
ESPT4M	End Spray Tube 1" NPT	
ESPNZ--	Nozzle with O-Ring (#20,26,32,38)	



INTRO
1. ELECTRICAL
2. PUMP, ACC.
3. HOSE, PE PIPE & ACC.
4. IPS, PIP PIPE & ACC.
5. SURFACE
6. SPRINKLERS
7. TRAVELER & WHEEL MOVE
8. PIVOT
9. TURF
10. LOW VOLUME
11. FILTERS
12. INJECTION
13. HARDWARE
INDEX

SENNINGER® FULL CIRCLE IMPACT SPRINKLERS

SENNINGER PIVOT MASTER® FULL CIRCLE LOW ANGLE IMPACTS - 6°

Part No.	Description	Price
3006H-1-3/4"-M-PM	3/4" MIPT Single Noz. 6° w/Brass Swivel (Less Noz.)	
4006H-1-3/4"-M-PM	3/4" MIPT Single Noz. 6° w/Brass Swivel (Less Noz.)	
5006H-1-3/4"-M-PM	3/4" MIPT Single Noz. 6° w/Brass Swivel (Less Noz.)	
4006H-2-3/4"-M-PM	3/4" MIPT Double Noz. 6° w/Brass Swivel (Less Noz.)	
5006H-2-3/4"-M-PM	3/4" MIPT Double Noz. 6° w/Brass Swivel (Less Noz.)	



SENNINGER PIVOT MASTER® FULL CIRCLE MEDIUM ANGLE IMPACTS - 12°

Part No.	Description	Price
2014HS-1-3/4"-M-PM	3/4" MIPT Single Noz. 14° w/Brass Swivel (Less Noz.)	
3012H-1-3/4"-M-PM	3/4" MIPT Single Noz. 12° w/Brass Swivel (Less Noz.)	
4012H-1-3/4"-M-PM	3/4" MIPT Single Noz. 12° w/Brass Swivel (Less Noz.)	
5012H-1-3/4"-M-PM	3/4" MIPT Single Noz. 12° w/Brass Swivel (Less Noz.)	
7012SD-2-1"-F	1" FIPT Double Nozzle 12° w/Plastic Swivel (Less Noz.)	



SENNINGER® FULL CIRCLE STANDARD ANGLE IMPACTS - 23° & 25°

Part No.	Description	Price
3023-1-3/4" M	3/4" MIPT Single Noz. 23° (Less Noz.)	
4023-1-3/4" M	3/4" MIPT Single Noz. 23° (Less Noz.)	
5023-1-3/4" M	3/4" MIPT Single Noz. 23° (Less Noz.)	
7025RD-2-1" F	1" FIPT Double Noz. 25° (Less Noz.)	
8025HR-2-1-1/4" F	1-1/4" FIPT Double Noz. 25° (Less Noz.)	



SENNINGER® NOZZLES AND VANES FOR IMPACTS

Description	20	30	40	50	70	80
RANGE NOZZLE / INSERTS						
NOZZLE-VANE COMBINATION						
SPREADER NOZZLE / INSERTS						
VANES						
RANGE NOZZLE EXTENSION						



SENNINGER® PLASTIC PART CIRCLE IMPACT SPRINKLERS

3123 NOZZLES #8-10

Part No.	Description	Price
3123PC-1-3/4"M	3/4" MIPT Plastic Swivel (Less Noz.)	
3123PC-1-3/4"F	3/4" MIPT Plastic Swivel with 3/4" Coupling (Less Noz.)	
3123PC-1-1"F	3/4" MIPT Plastic Swivel with 1" x 3/4" Coupling (Less Noz.)	



4123 NOZZLES #10-13

Part No.	Description	Price
4123PC-1-3/4"M	3/4" MIPT Plastic Swivel (Less Noz.)	
4123PC-1-3/4"F	3/4" MIPT Plastic Swivel with 3/4" Coupling (Less Noz.)	
4123PC-1-1"F	3/4" MIPT Plastic Swivel with 1" x 3/4" Coupling (Less Noz.)	



5123 NOZZLES #13-18

Part No.	Description	Price
5123PC-1-3/4"M	3/4" MIPT Plastic Swivel (Less Noz.)	
5123PC-1-3/4"F	3/4" MIPT Plastic Swivel with 3/4" Coupling (Less Noz.)	
5123PC-1-1F	3/4" MIPT Plastic Swivel with 1 x 3/4" Coupling (Less Noz.)	

LIMITED AVAILABILITY - PLEASE CALL FOR AVAILABLE SPRINKLER OPTIONS

RAIN BIRD® FULL CIRCLE IMPACT SPRINKLERS

Part No.	Description	Price
A06240	L20VH Wedge Drive 1/2" Male Single Nozzle 10°	
A06015	L20H 1/2" Male Single Nozzle 23°	
A05840	20JH 1/2" Male Single Nozzle 23°	
A07360	L36HB 3/4" Male Plastic w/ Brass Brg. Sleeve, Slotted Spoon 10°	
A07350	L36AHB 3/4" Male Plastic w/ Brass Brg. Sleeve, Regular Spoon 10°	
A11640	L3030H 3/4" Male Brass Double Nozzle 10°	
L46000	46H 3/4" Male Plastic Double Nozzle 23°	
A08401	30H 3/4" Male Brass Double Nozzle 27°	
A12800	14070H 3/4" Male Double Nozzle 27°	
A20000	70CH 1" Female Double Nozzle 21°	
A20030	70CHM 1" Male Double Nozzle 21°	
A23802	80EHD 1-1/4" Male Double Nozzle 27°	

Less Nozzle



RAIN BIRD® PART OR FULL CIRCLE IMPACT SPRINKLERS

Part No.	Description	Price
A34403-10	25BPJ-FP-ADJ-DA-TNT 1/2" Male Brass Impact, PJ Arm, with Diffuser & Distance Control and 5/32" Nozzle	
A39200	35A-TNT 3/4" Male Brass Impact Less Nozzle	
A4061312	35A-PJ-ADJ-TNT 3/4" Male Brass Impact with PJ Arm & ADJN-3 #12 (3/16") Nozzle	
AG2001	65PJ-TNT 1" Female Brass Impact with PJ Arm, Less Nozzle	
A23960	85EHD-LA 1-1/4" Male Brass Low Angle Impact, Less Nozzle 17°	



RAIN BIRD® NOZZLES & ACCESSORIES FOR IMPACT SPRINKLERS

Part No.	Description	Price
100225-xx	LAN-1-7 Brass 7° Low Angle Nozzle 1/2" Body	
100226-xx	LAN-1-20 Brass 20° Low Angle Nozzle 1/2" Body & Spreader Nozzle for 3/4" Bodies & 808A	
105780-xx	SBN-1 Brass Straight Bore Nozzle for 1/2" Body	
106160-xx	SBN-1V Brass Straight Bore Nozzle w/Vane for 1/2" Body	
105842-xx	SBN-3 Brass Straight Bore Nozzle for 3/4" Body	
106131-xx	SBN-3V Brass Straight Bore Nozzle w/Vane for 3/4" Body	
100382-xx	SBN-4 Brass Straight Bore Nozzle for 1" Body	
103043-xx	SBN-5 Brass Straight Bore Nozzle for 1-1/4" Body	
100418	SPB-1 Spreader Bushing for 1" Body	
105816	NV-3 Nozzle Vane for 3/4" Body	
101092-xx	ADJN-1V Brass Adjustable Nozzle w/Vane for 1/2" Body	
100328-xx	ADJN-3 Brass Adjustable Nozzle for 3/4" Body	
100385-xx	ADJN-4 Brass Adjustable Nozzle for 1" Body	
100332-xx	DAN-3 Brass Do-All Nozzle for 3/4" Body	
100255	Brass Plug for 1/2" Body	
100289	Brass Plug for 3/4" Body (range)	
100417	Brass Plug for 1" Body (spreader side)	
107881-xx	Quick-Fit Straight Bore Nozzle for L36 Impact	
109247-xx	Quick-Fit Low Pressure Nozzle for L36 Impact	
107881-99	Quick-Fit Plug for L36 Impact	



NELSON 3000 SERIES PIVOT PRODUCTS

As with all NELSON 3000 Series Pivot Products, each sprinkler type incorporates a user-friendly, modular design with quick change plastic color-coded nozzles. Each body type has a square thread which can be used with a standard 3/4" MPT by square thread adapter or matched with a square thread regulator which eliminates the need and cost of the adapter.

NELSON R3000 ROTATOR® (15-50 PSI)

R3000 Rotators offer a slow rotating plate which produces the widest pattern of any below mainline sprinkler. This results in a lower application rate, reduced runoff and longer soak times. R3000 Rotators are available with a wide range of plates with a variety of trajectories & groovings. Up top plates include the U4-8 degree blue and the new U6 multi-trajectory white. Drop plates include the D4-8 degree green, D6-12 degree red, a new D8 multi-trajectory orange & a new D10 multi-trajectory brown plate. Also available with TRASHBUSTER body (TR3000) to reduce the accumulation of debris on the body in dirty water applications. TR3000 rotators available with 3000FCN flow control nozzles for reduced chance of plugging.

Part No.	Description	Price
R3000	Complete Assembly w/3TN & 3/4" MNPT	
9410	3000 Adapter 3/4" MNPT	
9461-####	3TN Nozzle	
10106-####	3000 FCN Nozzle	
9412	R/S3000 Series Body	
10419	TRASHBUSTER Body	
Specify Color	R3000 Plates	
9539	R3000 Cap/Motor	



NELSON S3000 SPINNER (10-20 PSI)

S3000 Spinners utilize the higher speed spinning action of the rotor plate to produce a gentle rain-like droplet for sensitive soils and crops. A low pressure alternative to fixed sprayheads, the S3000 provides higher uniformity with better overlap and lower application rates. Available plates include the D6-12 degree red, D6-20 degree purple, D8 multi-trajectory yellow, and Beige single stream plate for small nozzles.

Part No.	Description	Price
S3000	Complete Assembly w/3TN & 3/4" MNPT	
9410	3000 Adapter 3/4" MNPT	
9461-####	3TN Nozzle	
10106-####	3000 FCN Nozzle	
9412	R/S3000 Series Body	
10419	TRASHBUSTER Body	
Specify Color	S3000 Plate	
9540	S3000 Cap/Motor	



NELSON A3000 ACCELERATOR (10-15 PSI)

Designed as a hybrid of Rotator® & Spinner technology, the Accelerator increases rotation speed as nozzle size increases. Smaller nozzles rotate slowly giving maximum distance of throw & reduced misting. As the nozzle size increases the plate speeds up keeping a uniform size droplet over a large range of nozzles. Created with corn in mind, the droplet size is healthy & the rotating streams penetrate through the foliage much better than conventional sprays. As a rotating type sprinkler the A3000 produces a wider pattern, compared to sprays, resulting in a lower application rate, reduced runoff, higher uniformity & longer soak times. The Gold Plate for the A3000 Accelerator creates a wide throw pattern, providing a lower application rate and longer soak time for better infiltration and reduced runoff. Choose the Maroon Plate for a low stream height and maximum wind-fighting performance. The new Navy A3000 Plate takes this low pressure Rotator technology to an up-top application.

Part No.	Description	Price
A3000	Complete Assembly w/3TN & 3/4" MNPT	
9410	3000 Adapter 3/4" MNPT	
9461-####	3TN Nozzle	
9428	A/D3000 Body	
9906	A3000 Plate	
10402	A3000 Cap/Motor	



NELSON 3000 SERIES PIVOT PRODUCTS

NELSON O3000 ORBITOR

Featuring technology that eliminates the struts of a sprinkler body, Nelson's new Pivot Orbitor provides outstanding uniformity and optimal droplets at low pressures (10-20 psi). Eliminating the struts means virtually no drip off the sprinkler head creating higher uniformity for your water pattern. Expect long wear life and durability in poor water conditions, because there are no sprinkler body struts for debris to hang up on. The O3000 Orbitor is available with the choice of three different plate options to meet specific irrigation needs. The standard angle (black plate) has 9 grooves for optimum uniformity and maximum throw. The low angle (blue plate) has 9 grooves and provides maximum wind-fighting ability. The fine droplet (purple plate) has 18 grooves for a consistent fine droplet pattern from an off-set axis sprinkler design.

Part No.	Description	Price
O3000	Complete Assembly	
9410	3000 Adapter 3/4" MNPT	
9461-###	3TN Nozzle Range #11-50	
11488-101	Orbitor & Weight with Black Standard Plate	
11488-102	Orbitor & Weight with Blue Low Angle Plate	
11488-103	Orbitor & Weight with Purple Smaller Droplet Plate	



NELSON D3000 SPRAYHEAD (6-40 PSI)

The flip over dual spray cap on the D3000 allows for easy conversion of the spray pattern. Choose from spray plate options to germinate, irrigate & chemigate. Plate selection includes 1)turquoise - smooth flat, 2) 30 stream fine groove in either green - concave, yellow - flat or purple - convex, 3)36 stream medium deep groove in either blue - concave or black - flat, 4)24 stream coarse deep groove gray - flat, 5)21 stream orange - coarse deep groove & 33 stream brown - medium deep groove multi-trajectory & 6)white - corn & cotton chemigation. For Low Energy Precision Application (LEPA), utilize HDA hose drag adapters to attach 3/4" drag hose or drag socks. You may also snap on a bubbler clip to create a LEPA bubbler. Circular design allows for easy passage through the thickest foliage.

Part No.	Description	Price
D3000	Complete Assembly w/3TN & 3/4" MNPT	
9410	3000 Adapter 3/4" MNPT	
9461-###	3TN Nozzle	
9428	A/D3000 Body	
9429	D3000 Cap	
Specify Color	D3000 Plate	
9427	HD Hose Drag Adapter	
10577	Bubbler Ring	



NELSON T3000 TRASHBUSTER SPRAYHEAD

Land application of wastewater through center pivots is proving itself to be an excellent solution. Proper waste management through a center pivot can be both cost effective & environmentally safe. Land applications of wastewater include livestock waste, municipalities, industrial processing & food processing. The T3000 TRASHBUSTERS open body design allows debris to pass off the plate with reduced opportunity of clinging to the struts. Although commonly used with medium 30 groove plates to reduce the chance of debris sticking to a deeper groove plate, the T3000 can be used with any D3000 plate when an open body is desired. The T3000 is also used with 3000FCN Flow Control Nozzles to reduce plugging.

Part No.	Description	Price
TD3000	Complete Assembly w/3TN & 3/4" MNPT	
9410	3000 Adapter 3/4" MNPT	
9461-###	3TN Nozzle	
10106-#####	3000FCN Flow Control Nozzle	
10419	T3000 Body	
Specify Color	T3000 Cap & Plate	



NELSON PART CIRCLE 3000 SERIES PIVOT PRODUCTS

The PART CIRCLE 3000 SERIES was developed for use on either side of pivot towers to reduce the amount of water applied to the wheel track area. The part circle directional control is produced by a stream deflector between the nozzle & the body. The stream deflector, plates & motors are unique to the PC R3000 Part Circle & PC S3000 Part Circle & may not be used with standard R3000 Rotators & S3000 Spinners. The PC D3000 Part Circle sprayhead is used mainly with low pressure spray systems. PART CIRCLE 3000 SERIES Sprinklers are also being used as endguns with great success. With up to 35 feet of throw & no stalling due to low pressure they are a problem free answer to adding productive acres to your field.

NELSON PC-R3000 PART CIRCLE ROTATOR® (15-30 PSI)

The PC R3000 Part Circle Rotator comes with three different plates. Use the white plate for nozzle sizes #14 - #23, tan plate for nozzle sizes #24-#39, and the black plate for nozzle sizes #40 - #50. Coarse grooved plates create healthy droplets that fight wind & increase distance of throw. The part circle mechanism comes as an assembly which includes the stream deflector, body, plate, cap & motor. 190° Arc with up to 35 feet of throw.

Part No.	Description	Price
PC-R3000	Complete Assembly w/3TN & 3/4" MNPT	
9410	3000 Adapter 3/4" MNPT	
9461-###	3TN Nozzle	
10843-###	PC R3000 Less Nozzle & Less Adapter	



NELSON PC-S3000 PART CIRCLE SPINNER (10-20 PSI)

The PC S3000 Part Circle Spinner uses one plate to cover the entire nozzle range of #14 - #40. Being in the Spinner family it produces a gentle, rain-like droplet. The part circle mechanism comes as an assembly which includes the stream deflector, body, plate, cap & motor. 190° Arc with up to 26 feet of throw.

Part No.	Description	Price
PC-S3000	Complete Assembly w/3TN & 3/4" MNPT	
9410	3000 Adapter 3/4" MNPT	
9461-###	3TN Nozzle	
9926-001	PC S3000 Less Nozzle & Less Adapter	



NELSON PC-D3000 PART CIRCLE SPRAYHEAD (10-20 PSI)

The PC D3000 Part Circle Sprayhead uses one plate to cover the entire nozzle range of #9 - #50. This 170° medium groove concave plate produces small streamlets that travel up to 19'. The body and plate come as an assembly.

Part No.	Description	Price
PC-D3000	Complete Assembly w/3TN & 3/4" MNPT	
9410	3000 Adapter 3/4" MNPT	
9461-###	3TN Nozzle	
9894-001	PC D3000 Less Nozzle & Less Adapter	



NELSON 3000 SERIES PIVOT PRODUCTS & ACCESSORIES

3TN NOZZLE CLIPS

Holds two or three separate 3TN nozzles for dual-flow sprinkler packages. Change flow rates quickly & accurately to meet differing application requirements & seasonal demands. No reading the printout on a wet or windy day & no searching through the bucket to find the right nozzle. Just twist off the body & flip the clip over.

3TN DUAL NOZZLE CLIP

Clips are clearly marked with a HI on the square side and LO on the rounded side.

Part No.	Description	Price
9742	Dual Nozzle Clip Only	

3TN TRIPLE NOZZLE CLIP

Three nozzle chambers clearly marked with a 1 LOW pointed side, a 2 MED round side & a 3 HIGH square side. Do not use with D3000 red plate.

Part No.	Description	Price
11089	Triple Nozzle Clip Only	

SPRINKLER CONVERTER

Use with A3000 & D3000 cap for 3 in one sprinkler. Configure different cap and plate options with the A3000/D3000 Body. Use an accelerator, spray, bubble or chemigate with one sprinkler.

Part No.	Description	Price
11472	Sprinkler converter	

D3000 BUBBLER ATTACHMENT

Part No.	Description	Price
10577	Bubbler Attachment	

SQUARE THREAD X HOSE BARB ADAPTER

For use when installing from 3/4" drop hose directly into a Nelson 3000 Series sprinkler. Eliminates additional fittings, saves time, and labor.

Part No.	Description	Price
9901	Square Thread x Hose Barb Adapter	

HD3000 HOSE DRAG ADAPTER

Part No.	Description	Price
9427	For LEPA use adapter to apply a hose drag or a drag sock.	

NELSON 3000 SERIES DROP WEIGHT

Part No.	Weight Lbs.	Price
10130	1 Lb. Modular Drop Weight	

NELSON 3000 SERIES BLUE TOP REGULATORS

Nelson introduces the new single strut regulator design. Instead of having 3 or 4 struts holding the regulator seat in place, all new Blue Top regulators will have one heavy duty strut only. This opens up the seat area to help reduce plugging on the upstream side of the regulator. Along with the standard 3/4" FIPT by 3/4" FIPT model, Nelson makes the 3/4" FIPT by square thread (ST) model. This eliminates the need & cost of a threaded adapter, as the regulator screws directly into the body of any 3000 Series sprinkler.

PSI	Universal-Flo (GPM)	Hi-Flo (GPM)
6	.5 - 8	4 - 16
10	.5 - 10	4 - 16
15, 20, 25, 30, 40	.5 - 12	2 - 20

Part No.	Description	Price
9572-0XX*	Universal-Flo Square Thread	
9491-0XX*	Universal-Flo 3/4" FIPT	
9611-0XX*	Hi-Flo Square Thread	
9071-0XX*	Hi-Flo 3/4" FIPT	

Please specify size.

* 01 = 6PSI, 02 = 10PSI, 03 = 15PSI, 04 = 20PSI, 05 = 25PSI, 06 = 30PSI, 07 = 40PSI



NELSON Impacts are of the highest quality. Every impact is individually water tested before it leaves the factory. Extended life bearings make for longer life and wear.

NELSON FULL CIRCLE IMPACTS

Part No.	Description	Price
7185-210	L20-04T 3/4" Male Brass Single Nozzle 9°	
6902	F33AS 3/4" Male Brass Single Nozzle 15°	
6717	F33AA 3/4" Male Brass Double Range Nozzle 15°	
8718	F44AAB 3/4" Male Plastic Double Range Nozzle 8°	
6903	F43A 3/4" Male Brass Double Nozzle 15°	
7316	F70M 1" Male Brass Double Nozzle 25°	
7118	F70AM 1" Male Brass Double Nozzle 15°	
8732	F80 1-1/4" Male Brass Double Nozzle 24°	
7155	F80A 1-1/4" Male Brass Double Nozzle 18°	

Less Nozzle



NELSON PART OR FULL CIRCLE BRASS IMPACTS

Part No.	Description	Price
8805	P65M 1" Male Single Nozzle 24°	
8426	P85 1-1/4" Male Double Nozzle 24°	
8079	P85AS 1-1/4" Male Single Nozzle 18°	

Less Nozzle

For the P85A refer to sprinkler section.



NELSON NOZZLES, VANES & ACCESSORIES

Part No.	Description	Price
3RN	Brass Nozzle for 3/4" Impacts	
2FCN	Flow Control Nozzle for L20-04T	
3FCN	Flow Control Nozzle for F33AS, F33AA & F44AAB	
7RN	Drive Nozzle F70M, F70AM & P65M	
8DRN	Drive Nozzle F80, F80A, P85, P85A & P85AS	
3RNPLUG	Brass Secondary Plug for F70A, F80A, P85, F44AAB	
3V	Stream Straightener for F33AS & F33AA	
4V	Stream Straightener for F44AAB & F43A	
7V	Stream Straightener for F70M, F70AM & P65M	
8V	Stream Straightener for all 80 & 85 Series Impacts	
8ADN	Adjustable Diffuser Assembly (Including Nozzle)	
8DN	Diffuser Assembly Only (No Nozzle)	
7198	F70 1" FC Bearing Assembly	
7197	F80 1-1/4" FC Bearing Assembly	
8806	P65 1" PC Bearing Assembly	
9036	P85 1-1/4" PC Bearing Assembly	
7714	P85A & P85AS 1-1/4" PC LA Bearing Assembly	



NELSON PURGE VALVE

Part No.	Description	Price
10474	1.5" MNPT	
10474-001	1.5" MBSP	

Install at the end of center pivot systems for automatic flushing at start-up and shut-down — or, configure with an electric solenoid interfaced with the center pivot for automatic flushing while system is operating.



PIVOT FLUSHER

The Pivot Flusher removes sand and sediment (up to 1/4" diameter) from any standard pressure mechanical move irrigation system. With the start of each irrigation cycle, the Pivot Flusher is activated using water pressure. It will flush your system for a few seconds and slowly close so your system can operate normally. When the cycle is complete, the Pivot Flusher resets, so it can begin the next flush.



PIVOT FLUSHER

Part No.	Description	Price
PIVOTFLUSHER	Attaches to a 2" drain plug.	

END GUN SPRINKLER

The Nelson R55A sprinkler is truly "Sprinkler Technology for the Future". No other end of pivot sprinkler works in the low pressure range of 15-30 PSI and provides up to 10 additional irrigated acres on a 1/4 mile pivot. Conceptually designed with Nelson's field proven Rotator technology, it is manufactured with a durable cast aluminum body and a wear-resistant plate to handle abrasive end-of-system water. It comes with one of four easy to install color-coded nozzles. The R55A is an excellent option for replacing standard 1-1/4" brass impacts that are less effective at low pressure. It has a uniform spray pattern and is highly efficient, producing low trajectory streams and large droplets that penetrate the wind and resist evaporation and drift. The R55A is cost effective at half the price of traditional brass impact sprinklers, allowing you to irrigate more ground with less money. This is a end of pivot sprinkler that you really ought to try!



40-50'
(12-15m) Radius
@15-30 PSI
(1.0-2.1 bar)



NELSON R55A LOW PRESSURE END OF PIVOT SPRINKLER

Part No.	Description	Price
12009	R55A Body Assembly	
11790-060	Red Nozzle, R55	
11790-070	Yellow Nozzle, R55	
11790-080	Green Nozzle, R55	
11790-090	Blue Nozzle, R55	

PRELIMINARY PERFORMANCE (U.S. UNITS)

Pressure (PSI)	#60 Red Nozzle		#70 Yellow Nozzle		#80 Green Nozzle		#90 Blue Nozzle	
	Flow (gpm)	Radius (ft)	Flow (gpm)	Radius (ft)	Flow (gpm)	Radius (ft)	Flow (gpm)	Radius (ft)
15	27.7	40	36.6	40	45.2	41	52.0	43
20	31.8	43	41.8	43	51.7	44	59.7	46
25	35.5	45	46.7	45	57.7	46	66.7	48
30	38.9	46	51.1	46	63.1	47	73.2	49



To assemble the R55A, (1) place the body on the nozzle while aligning the notch in the body to the corresponding notch on the nozzle. Then, (2) slide the pin(s)* into the hole(s) to secure parts.

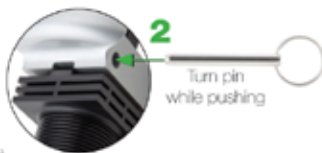

*Number of Pins



Use two pins if there are indentations on both sides of the nozzle



Use one pin if there is only one indentation on the nozzle

OPERATING PRESSURE MUST BE 15-30 PSI (1-2 BAR)

AVOID TURBULENT CONFIGURATIONS

NELSON BIG GUN® SPRINKLERS

NELSON BIG GUN SPRINKLERS

Part No.	Description	Price
10279-118	F75 x 18° x 2" Full Circle w/HD Lower Bearing	
10279-121	F75 x 21° x 2" Full Circle w/HD Lower Bearing	
10279-124	F75 x 24° x 2" Full Circle w/HD Lower Bearing	
10229-118	SR75 x 18° x 2" Part Circle w/HD Lower Bearing	
10229-121	SR75 x 21° x 2" Part Circle w/HD Lower Bearing	
10229-124	SR75 x 24° x 2" Part Circle w/HD Lower Bearing	
8211-038	F100 x 18° x 2" Full Circle w/HD Lower Bearing	
8211-042	F100 x 21° x 2" Full Circle w/HD Lower Bearing	
8211-046	F100 x 24° x 2" Full Circle w/HD Lower Bearing	
8211-147	QC-F100 x 24° Full Circle w/Integral Valve Key	
8211-098	SR100 x 18° x 2" Part Circle w/HD Lower Bearing	
8211-102	SR100 x 21° x 2" Part Circle w/HD Lower Bearing	
8211-106	SR100 x 24° x 2" Part Circle w/HD Lower Bearing	
8211-143	QC-SR100 x 24° Part Circle w/Integral Valve Key	
8211-110	SRNV100E x 18° Part Circle w/Solenoid	
9643	SRNV100H x 18° x 2" Part Circle w/out Solenoid	
10338-001	SRA100 Adjustable Trajectory - 2" FNPT or FBSP	
9455-021	F150 x 21° Full Circle - Flanged Connection	
9455-024	F150 x 24° Full Circle - Flanged Connection	
8463-221	SR150 x 21° Part Circle - Flanged Connection	
8463-224	SR150 x 24° Part Circle - Flanged Connection	
9292-001	SR150 x 43° Part Circle - Flanged Connection	
10055-001	SRA150 Adjustable Trajectory - Flanged Connection	
6080	F200 x 21° Full Circle - Flanged Connection	
6260	F200 x 24° Full Circle - Flanged Connection	
6000	F200 x 27° Full Circle - Flanged Connection	
9192-021	SR200 x 21° Part Circle - Flanged Connection	
9192-024	SR200 x 24° Part Circle - Flanged Connection	
9192-027	SR200 x 27° Part Circle - Flanged Connection	
(1)	for Anodized F100 or SR100 add	
(2)	for Anodized & Powder Coated F100 or SR100 add	
(3)	for Anodized F150 or SR150 add	
(4)	for Anodized & Powder Coated F150 or SR150 add	
(5)	for Anodized SR200 add	
(6)	for Anodized & Powder Coated SR200 add	



Note: Heavy Duty Bearing is standard on all Big Gun Sprinklers.
Coating options not available for F200.

TRAJECTORIES AVAILABLE

Big Gun®	Trajectory Angle
75 SERIES	18°, 21°, 24°, 43°
100 SERIES	18°, 21°, 24°, 43°, 15°- 45° Adjustable
150 SERIES	21°, 24°, 27°, 43°, 15°- 45° Adjustable
200 SERIES	21°, 24°, 27°

CONNECTIONS AVAILABLE

Big Gun®	Size Connections
75 SERIES	1-1/2", 2" FNPT, ANSI/DIN, Nelson, Metric
100 SERIES	2" or 2-1/2" FNPT & ANSI/DIN, Nelson, Metric
150 SERIES	3" or 3-1/2" FNPT x Flange & ANSI/DIN, Nelson, Metric
200 SERIES	3-1/2" or 4" FNPT x Flange & ANSI/DIN, Nelson, Metric



75 SERIES TAPER RING

Part No.	Description	Price
10208-040	TR75 .40"	
10208-045	TR75 .45"	
10208-050	TR75 .50"	
10208-055	TR75 .55"	
10208-060	TR75 .60"	
10208-065	TR75 .65"	
10208-070	TR75 .70"	
10208-075	TR75 .75"	
10208-080	TR75 .80"	
10207	Noz. Cap Only	



100 SERIES TAPER BORE NOZZLES

Part No.	Description	Price
9309-050	100T .50"	
9309-055	100T .55"	
9309-060	100T .60"	
9309-065	100T .65"	
9309-070	100T .70"	
9309-075	100T .75"	
9309-080	100T .80"	
9309-085	100T .85"	
9309-090	100T .90"	
9309-100	100T 1.0"	



100 SERIES RING NOZZLES

Part No.	Description	Price
6749	100R Ring Nozzle Set	
7872	Ring Nozzle Cap Only (use only with 100R)	
6745	Ring Nozzle Cap Only (use only with 100TR)	
9956-001	Ring or Taper Ring Nozzle Body Only	
6847	Set of 7 Rings Only	
6738-060	R100 .60" Individual Ring Only	
6738-071	R100 .71" Individual Ring Only	
6738-077	R100 .77" Individual Ring Only	
6738-081	R100 .81" Individual Ring Only	
6738-086	R100 .86" Individual Ring Only	
6738-089	R100 .89" Individual Ring Only	
6738-093	R100 .93" Individual Ring Only	
6738-096	R100 .96" Individual Ring Only	

Note: Add 15% for Anodized 100 Series Nozzles.
Add 60% for Anodized & Powder Coated 100 Series Nozzles



100 SERIES TAPER RINGS

Part No.	Description	Price
9237-016	TR100 .63" Individual Taper Ring 16MM	
9237-017	TR100 .67" Individual Taper Ring 17MM	
9237-018	TR100 .71" Individual Taper Ring 18MM	
9237-019	TR100 .75" Individual Taper Ring 19MM	
9237-020	TR100 .79" Individual Taper Ring 20MM	
9237-021	TR100 .83" Individual Taper Ring 21MM	
9237-022	TR100 .87" Individual Taper Ring 22MM	
9237-023	TR100 .91" Individual Taper Ring 23MM	
9237-024	TR100 .95" Individual Taper Ring 24MM	



150 SERIES TAPER BORE NOZZLES

Part No.	Description	Price
9317-070	150T .70" Taper Bore Nozzle	
9317-080	150T .80" Taper Bore Nozzle	
9317-090	150T .90" Taper Bore Nozzle	
9317-100	150T 1.0" Taper Bore Nozzle	
9317-110	150T 1.1" Taper Bore Nozzle	
9317-120	150T 1.2" Taper Bore Nozzle	
9317-130	150T 1.3" Taper Bore Nozzle	
9317-140	150T 1.4" Taper Bore Nozzle	



150 SERIES RING NOZZLES

Part No.	Description	Price
6790	150R Ring Nozzle Set	
6286	Ring Nozzle Cap Only	
9773	Ring Nozzle Body Only	
6846	Set of 7 Rings Only	
6287-086	R150 .86" Individual Ring Only	
6287-097	R150 .97" Individual Ring Only	
6287-108	R150 1.08" Individual Ring Only	
6287-118	R150 1.18" Individual Ring Only	
6287-126	R150 1.26" Individual Ring Only	
6287-134	R150 1.34" Individual Ring Only	
6287-141	R150 1.41" Individual Ring Only	
6287-147	R150 1.47" Individual Ring Only	

Note: Add 10% for Anodized 150 Series Nozzles.
Add 40% for Anodized & Powder Coated 150 Series Nozzles



INTRO
1. ELECTRICAL
2. PUMP Acc.
3. HOSE, PE PIPE & Acc.
4. IPS, PIP PIPE & Acc.
5. SURFACE
6. SPRINKLERS
7. TRAVELER & WHEEL MOVE
8. PIVOT
9. TURF
10. LOW VOLUME
11. FILTERS
12. INJECTION
13. HARDWARE
INDEX

150 SERIES TAPER RINGS

Part No.	Description	Price
9238-022	TR150 22MM (.87")	
9238-024	TR150 24MM (.95")	
9238-026	TR150 26MM (1.02")	
9238-028	TR150 28MM (1.10")	
9238-030	TR150 30MM (1.18")	
9238-032	TR150 32MM (1.26")	
9238-034	TR150 34MM (1.33")	



200 SERIES TAPER BORE NOZZLES

Part No.	Description	Price
9323-105	200T 1.05"	
9323-110	200T 1.10"	
9323-120	200T 1.20"	
9323-130	200T 1.30"	
9323-140	200T 1.40"	
9323-150	200T 1.50"	
9323-160	200T 1.60"	
9323-175	200T 1.75"	
9323-190	200T 1.90"	



200 SERIES RING NOZZLES

Part No.	Description	Price
6789	200R Ring Nozzle Set	
9972-001	Ring Nozzle Body, Only	
6026	Ring Nozzle Cap, Only	
6845	Set of 7 Rings Only	
6027-129	R200 1.29" Individual Ring Only	
6027-146	R200 1.46" Individual Ring Only	
6027-156	R200 1.56" Individual Ring Only	
6027-166	R200 1.66" Individual Ring Only	
6027-174	R200 1.74" Individual Ring Only	
6027-183	R200 1.83" Individual Ring Only	
6027-193	R200 1.93" Individual Ring Only	

Note: Add 7% for Anodized 200 Series Nozzles.
Add 27% for Anodized & Powder Coated 200 Series Nozzles.



100 SERIES HEAVY-DUTY LOWER BEARING

Part No.	Description	Price
7863	2" FNPT Full Circle Bearing Assembly	
7864	1-1/2" FNPT Full Circle Bearing Assembly	
7862	Flanged Full Circle Bearing Assembly	
7273	2" Part Circle Bearing Assembly	
7277	2-1/2" Part Circle Bearing Assembly	
7753	Flanged Part Circle Bearing Assembly	
10265-201	ANSI Flanged, Full Circle Bearing Assembly	
10265-001	ANSI Flanged, Part Circle Bearing Assembly	
7950	2" FNPT Part Circle Nozzle Valve Bearing Assy.	



150 & 200 SERIES LOWER BEARING ASSEMBLY

Part No.	Description	Price
8458	150 Series Lower Bearing Assembly Flg. Conn.	
10323-001	150 Series Lower Bearing Assembly ANSI Conn.	
9114-000	200 Series Lower Bearing Assembly Flg. Conn.	
9114-003	200 Series Lower Bearing Assembly ANSI Conn.	



BIG GUN® ACCESSORIES

Part No.	Description	Price
8403-001	150FI 3" FNPT x Flange Adapter	
6621-00	200FI 3 1/2" FNPT x Flange Adapter	
9127	200FI 4" FNPT x Flange Adapter	
9724	Secondary Nozzle Kit	
9822	SR100 & SR150 Drive Arm Maintenance Kit	
9857	SR100 LPV Kit (low pressure drive vane)	
6671	600V Stream Straightener Vane (fits 2" x 6" riser)	
8386	100CBK Series Counter Balance Kit	
8399	150CBK Series Counter Balance Kit	
11090	75 Drive Arm Maintenance Kit	
10088-###	100FI 2" or 2-1/2" FNPT x Flanged Adapter	
10565	ANSI Flange Adapter (F200 Only)	



The AquaDock™ is designed to allow you to take a sprinkler head on a hose drop and move it up as your crop grows taller. There are 4 different docking systems to meet your specific needs. All the raising of the sprinkler heads is with a simple lift-pole and is done from the ground. No more walking the span with potentially hazardous results. No more dry rings caused by drop interference. No more wrapping and unwrapping hose. Be sure to use a thicker non-kinking hose like the Goodyear® Sureline®.

AquaDock™ #1 - Gooseneck Mount to retrofit your current Center Pivot.
 This version of AquaDock™ mounts directly to the gooseneck on the span and the docking mount collar attaches solidly to the drop hose. This application is for all non-vibrational sprinklers that work in both the upright and inverted position.

A simple lift-pole allows you to place the collared sprinkler head on the docking station with ease and safely from the ground.

AquaDock™ #2 Gooseneck Mount with adjustable docking collar.
 This version of AquaDock™ mounts solidly to the gooseneck on the span. The adjustable docking mount collar attaches to the drop hose. This application is for all types of sprinklers, vibrational or non-vibrational.

AquaDock™ #3 Span Mount for new machines or retrofit existing systems.
 The AquaDock™ Span Mount clamps around 6-5/8" pipe with a built-in clamp for the hose to keep stress off bulkhead fittings on the new polylined center pivot machines.

Our Span Mount also secures the span electrical cable at every sprinkler to deter theft. There are three holes in the 10, 12, and 2 o'clock positions to allow for easy alignment.

The AquaDock™ Span Mount holds in a sweep to allow water to flow unimpeded to the sprinkler. The docking station holds hoses at elevated position and holds sprinklers in the overhead position for better water distribution eliminating the need for the gooseneck.

AquaDock™ #4 Span Mount for new machines or retrofit existing systems.
 The AquaDock™ #4 is also a Span Mount, but close to the tower and is designed for alignment rod clearance issues.

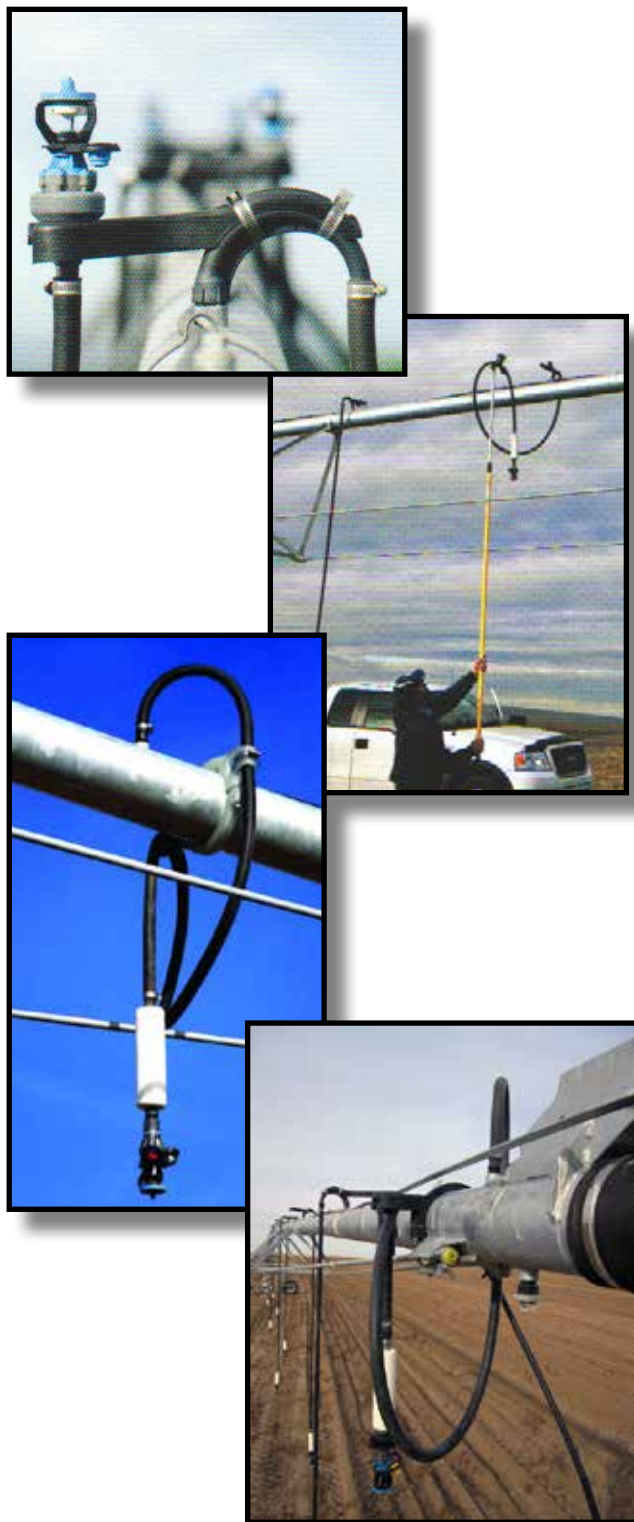

AQUADOCK™ MOUNTING KITS

Part No.	Description	Price
AquaDock#1	Mounting Dock & Sprinkler Dock Collar	
AquaDock#2	Mounting Dock & Hose Dock Collar	
AquaDock#3	Span Mount Dock & Hose Dock Collar	
AquaDock#4	Span Mount Tower Dock & Hose Dock Collar	

- INTRO
- 1. ELECTRICAL
- 2. PUMP ACC.
- 3. HOSE, PE PIPE & ACC.
- 4. IPS, PIP PIPE & ACC.
- 5. SURFACE
- 6. SPRINKLERS
- 7. TRAVELER & WHEEL MOVE
- 8. PIVOT
- 9. TURF
- 10. LOW VOLUME
- 11. FILTERS
- 12. INJECTION
- 13. HARDWARE
- INDEX

NETAFIM™ CONTROL VALVES

Netafim™ Control Valves are available in a wide range of sizes and flow rates to cover most applications. These iron valves have a protective polyester coating that is resistant to corrosive elements. The unique design allows a straight flow pattern with low friction loss. A direct sealing diaphragm, the valves only moving part, operates by pipeline or external pressure. Sizes range from 1" to 24" with a variety of control functions and connection options. These valves are excellent for high pressure applications, drip and sprinkler irrigation systems, or for linear and center pivot control. Maximum working pressure is 230 PSI. Optional control functions include: manual, electrical, pressure reducing, pressure sustaining, remote control and flow control. Each valve is custom built to order and tested before shipping.



BASIC VALVES

Part No.	Description	Price
61B2IT-XX	2" Basic Hydraulic Control*	
61B2-TH-AN	2" Basic Angle Hydraulic Threaded	
61B4IF-XX	4" Basic Hydraulic Flange*	
61B6IFCP	6" Basic Hydraulic Flange	
61B8IFCP	8" Basic Hydraulic Flange	
61B868IF-XX	868 Basic Hydraulic Flange	
61B10IF	10" Basic Hydraulic Flange	
* Substitute XX with HP or LP.		

MANUAL VALVES

Part No.	Description	Price
61M2IT-HP	2" Manual Threaded	
61M4IF-HP	4" Manual Flange	
61M6IF-HP	6" Manual Flange	
61M868IF-HP	868 Manual Flange	
61M8IF	8" Manual Flange	
61M10IF	10" Manual Flange	

ELECTRIC VALVES-120V

Part No.	Description	Price
61EL2IT-HPCP	2" Electric Threaded	
61EL2B-ANCP	2" Angle Electric Threaded	
61EL4IFCP	4" Electric Flange	
61EL6IFCP	6" Electric Flange	
61EL8IFCP	8" Electric Flange	
61EL868IFCP	868 Electric Flange	
61EL10IF	10" Electric Flange	

MANUAL ELECTRIC VALVES

Part No.	Description	Price
61MEL2IT-HP	2" Manual Electric Threaded	
61MEL4IFCP	4" Manual Electric Flange	
61MEL6IFCP	6" Manual Electric Flange	
61MEL868IF-HP	868 Manual Electric Flange	
61MEL8IF	8" Manual Electric Flange	
61MEL10IF	10" Manual Electric Flange	

PRESSURE REDUCING VALVES-120V

Part No.	Description	Price
61PREL4IFCP-X	4" Pressure Reducing Electric Flange	
61PR4IF-X	4" Pressure Reducing Valve Flange	
61PREL6IFCP-X	6" Pressure Reducing Electric Flange	
61PR6IF-X	6" Pressure Reducing Valve Flange	
61PREL8IFCP-X	8" Pressure Reducing Electric Flange	
61PR8IF-X	8" Pressure Reducing Valve Flange	
61PREL868IFCP-X	868 Pressure Reducing Electric Flange	
61PR868IF-X	868 Pressure Reducing Valve Flange	
61PREL10IF-X	10" Pressure Reducing Electric Flange	
61PR10IF-X	10" Pressure Reducing Valve Flange	
Substitute X with Y, G or B for downstream pressure.		

PRESSURE REDUCING VALVE SPRING RANGES

Part No.	Description
1" to 4" Valves Spring Range:	Y - Yellow (7-30 PSI)
	G - Green (14-65 PSI)
	R - Red (30-90 PSI)
6" to 24" Valves Spring Range:	Y - Yellow (8-45 PSI)
	G - Green (14-90 PSI)
	R - Red (30-130 PSI)
	B - Black (100-285 PSI)

XCAD AUTOMATIC CONTROL VALVES

SMV BASIC VALVES

Part No.	Description	Price
SMV75B	3/4" NPT Threaded	
SMV1B	1" NPT Threaded	
SMV2B	2" NPT Threaded	
SMV902B	2" 90° NPT Threaded	



SMV ELECTRIC ON/OFF

Part No.	Description	Price
SMV75WS	3/4" NPT Threaded	
SMV1WS	1" NPT Threaded	
SMV2WS	2" NPT Threaded	
SMV902WS	2" 90° NPT Threaded	



SMV DIAPHRAGM

Part No.	Description	Price
SMV75DIA	3/4" Diaphragm	
SMV1DIA	1" Diaphragm	
SMV2DIA	2" Diaphragm	



END GUN CONTROL VALVE

AQUAMATIC END GUN CONTROL VALVE

The industry standard for years, these metal diaphragm valves are available from 3/4" through 4". These valves can be electrically or hydraulically activated. When ordering, please specify desired solenoid voltage if electric, and whether the valve will be mounted horizontally or vertically.



CONTROL VALVE WITH SOLENOID

Size	CV(1) 1 PSI LOSS@ GPM	Part No.	Price With Solenoid
3/4"	11.5	V42B-0000-00111	
1"	13	V42C-0000-00111	
1-1/4"	26.5	V42D-0001-00111	
1-1/2"	32.5	V42E-0001-00111	
*2"	56	V42F-0001-00111	
2.5 BODY, 2" MIPT	68	V42G-0001-00111	
2-1/2"	84	V42H-0001-00111	
3" FLG	135	V42J-3001-00111	
4" FLG	275	V42K-3001-00111	

CONTROL VALVE WITHOUT SOLENOID

Size	CV(1) 1 PSI LOSS@ GPM	Part No.	Price Without Solenoid
3/4"	11.5	V42B-0000-0000	
1"	13	V42C-0000-0000	
1-1/4"	26.5	V42D-0001-00100	
1-1/2"	32.5	V42E-0001-00100	
*2"	56	V42F-0001-00100	
2.5 BODY, 2" MIPT	68	V42G-0001-00100	
2-1/2"	84	V42H-0001-00100	
3" FLG	135	V42J-3001-00100	
4" FLG	275	V42K-3001-00100	

* 2" Valve available with solenoid in either a vertical (V) mount position or horizontal (H) mount position for proper endgun drainage to reduce the possibility of damage due to freezing. Specify either a vertical or horizontal valve when ordering.

NOTE: (1) All electric valves are equipped with a 110VAC solenoid unless otherwise specified.

(2) All valves are normally open (NO) unless otherwise specified.

(3) All valves are cast iron with buna seals & diaphragms unless otherwise specified.

(4) All valves larger than 1" are equipped with spring assist to open (SAO) and the #1 hole drilled and tapped to accept solenoid.

Call for "options" pricing. Options: normally closed, spring assist open, spring assist closed, Limit Stop, Viton Seals, Solenoids with 24VAC, 24VDC, 12VDC, 220VAC, Drill & Tap Bosses.

INTRO
 1. ELECTRICAL
 2. PUMP Acc.
 3. HOSE, PE PIPE & Acc.
 4. IPS, PIP Pipe & Acc.
 5. SURFACE
 6. SPRINKLERS
 7. TRAVELER & WHEEL MOVE
 8. PIVOT
 9. TURF
 10. LOW VOLUME
 11. FILTERS
 12. INJECTION
 13. HARDWARE
 INDEX

END GUN CONTROL VALVE ACCESSORIES

AQUAMATIC VALVE PARTS

Part No.	Description	Price
348BD	Strainer Assembly with Filter	
348Z	Solenoid Elbow (1/8" MIPT x 1/4" FIPT)	
421-C	3/4" and 1" Valve Cast Iron Cap	
424-C	1-1/4" and 1-1/2" Valve Cast Iron Cap	
425-C	2" Valve Cast Iron Cap	
421-RA	3/4" and 1" Valve Diaphragm Assembly	
424-RA	1-1/4" and 1-1/2" Valve Diaphragm Assembly	
425-RA	2" Valve Diaphragm Assembly	
Other parts and sizes available upon request		



3-WAY SOLENOIDS

Part No.	Description	Price
PKSOL-120UN	120 VAC Solenoid, Unpotted	
PKSOL-120AC	120 VAC Solenoid, Potted	
PKSOL-24AC	24 VAC Solenoid	
PKSOL-24DC	24 VDC Solenoid	
PKSOL-12DC	12 VDC Solenoid	
PKSOL-12DCL	12 VDC Latching Solenoid	



COILS

Part No.	Description	Price
PKHS	Coil Housing	
PKCOIL-12DC	12 VDC Coil Only	
PKCOIL-24DC	24 VDC Coil Only	
PKCOIL-24AC	24 VAC Coil Only	
PKCOIL-120AC	120 VAC Coil Only	
PKPOT-120AC	120 VAC Coil with Housing, Potted	



PUSH-IN FITTINGS & TUBING

Part No.	Description	Price
MZ-NYL-1/4-FT	1/4" Nylon Tubing per Foot	
MZ-NYL-1/4-100	1/4" Nylon Tubing - 100 Ft. coil	
MZ-NYL-1/4-500	1/4" Nylon Tubing - 500 Ft. coil	
NOR-12-020-0400	1/4" Tube Union Coupling	
NOR-12-060-0400	1/4" Tube Union Tee	
NOR-12-425-0418	1/4" Tube x 1/8" MIPT Adapter	
NOR-12-425-0428	1/4" Tube x 1/4" MIPT Adapter	
NOR-12-447-0418	1/4" Tube x 1/8" MIPT Swivel Elbow	
NOR-12-447-0428	1/4" Tube x 1/4" MIPT Swivel Elbow	
NOR-12-467-0418	1/4" Tube x 1/8" MIPT Swivel Tee	
NOR-12-467-0428	1/4" Tube x 1/4" MIPT Swivel Tee	



END GUN BOOSTER PUMP

PIVOT END GUN BOOSTER PUMP & ACCESSORIES

This quality booster pump is built to meet the heavy-duty demands of its application. It is available as a 2HP model. No need to disturb pipe for normal maintenance. It has the same housing design as Berkley and will interchange with Berkley. Simply unbolt the old Berkley unit and replace it with the X-CAD model.

PIVOT END GUN BOOSTER PUMP

Part No.	Description	Price
BP2HP	2HP Booster Pump	
BP2HPNV	2HP, No Volute	

2-HP IRRIGATION BOOSTER PUMP MOTOR

Part No.	Description	Price
BPM2HP	2HP, 130 GPM, Motor Only	

BERKELEY BOOSTER PUMP

Part No.	Description	Price
B85475	Berkeley 2 HP	
B85475NV	Berkeley 2 HP No Volute	

BOOSTER PUMP COMPONENTS

Part No.	Description	Price
BPVC	Volute Case	
BPMBKT	Motor Bracket	
BPIMP-SS	Stainless Steel Impeller	
BPGSKT	Mylar Motor Gasket	
BPCGSKT	Paper Motor Case Gasket	
BPIMPSPC	Impeller Spacer	
BPSEAL	Shaft Seal	

GRUNDFOS BOOSTER PUMPS

Part No.	Description	Price
98284727	2HP Booster Pump	
98284725	5HP Booster Pump	

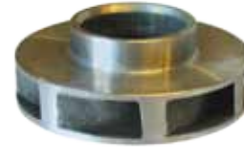

PIVOT DRIVE COMPONENTS

TELESCOPING DRIVELINE WITH COUPLER ENDS

This is the ultimate time saving device. Typical installation requires 5-10 minutes. The telescoping feature makes lengths easily adjustable without having to cut driveshafts in the field. Heavy-duty materials and construction provides more durability than standard driveshafts. Made of square steel tube with 1" round ends for connection to gear boxes.

Part No.	Description	Price
PDLEXP	Telescoping Driveline w/Coupler Ends	



UNIVERSAL DRIVELINE COUPLERS

- One size fits all 3/4", 7/8" and 1" driveshafts • Flex in the disc eliminates shock on start up • No slack anyplace - takes jump out of gearboxes • Slotted 1" round end allows for tightening on worn shafts and prevents the U-Joint from freezing on the shaft • The disc is the only part that wears and it can be easily replaced • Clamps on to twisted driveshafts • Made with a milled angle for a tighter fit • Only 3 bolts and 5 nuts to tighten (stainless steel) • One 9/16" wrench fits everything • Longer lasting than aluminum couplers

UNIVERSAL STEEL DRIVELINE COUPLER

Part No.	Description	Price
U-JOINT-4.5	Universal Steel Driveline Coupler w/Large Disc	
U-JOINT-3.5	Universal Steel Driveline Coupler w/Small Disc (Bell-Insert)	
U-JOINT-DISC-LG	Large Disc for Steel U-Joint	
U-JOINT-DISC-SM	Small Disc for Bell Insert	
U-JOINT-BOLTKIT	Angle Bolt, Nuts, and Washers	



UNIVERSAL STEEL DRIVELINE COUPLER

Part No.	Description	Price
PDLVBLT	U-JOINT-3.5 with Small Disc	



UNIVERSAL U-JOINT

Part No.	Description	Price
PDLUNIV	Universal U-Joint for 3/4" or 7/8" Driveshafts	

This U-Joint quickly attaches to both 3/4" and 7/8" driveshafts.
Slotted 1" round end attaches to gearbox.



UMC DRIVELINE COUPLERS

UMC C-X COUPLER

Part No.	Description	Price
01355-133A	UMC (Universal Multi-Shaft Coupler)	

- Units come pre-assembled
- Universal design - Fits all square shaft sizes - Standard and Metric square shaft
- Simple one wrench installation
- UV stabilized Urethane puck
- Easily converts from Non-Towable to Towable
- Centering rod for maintaining alignment at peak torque
- SQUEX Bolts (Square Neck - Hex Head) for easy one wrench installation
- Meets and exceeds the existing UMC coupler performance



Up to 5% stronger than normal coupler (depending on installation)

UMC ALUMINUM DRIVELINE COUPLERS WITH POLYURETHANE PUCK

Provides an added strength shock absorbing drive connection between Power Savers and Final Drive Gearboxes providing increased life for both units. The addition of the alignment rod helps to keep concentric alignment under extreme loads. The added strength is for use in heavy soils and on systems with larger diameter tires. Models vary based on size and configuration of application ends. Special insert available for towable applications.

Part No.	Description	Qty. 1-42	Qty. 43 +
01355-121J	1" RD. & 7/8" SQ. x 1-1/8" RD. & 1" SQ.		
01355-111I	1-1/8" RD. & 1" SQ. x 1-1/8" RD. & 1" SQ.		
01355-121L	1" RD. & 7/8" SQ. w/Key Slot x 3/4" SQ.		
01355-121M	1" RD. & 7/8" SQ. x 1" RD. & 7/8" SQ. (Towable)		
01355-121N	1" RD. & 7/8" SQ. x 3/4" SQ. (Towable)		
01355-121P	1" RD. & 7/8" SQ. w/Key Slot x 3/4" SQ. (Towable)		
01352-104C	Bolt Kit		
06550-704C	Polyurethane Replacement Pucks (Towable)		



- Alignment rod holds both insert in place and coupler in alignment under extreme or sudden loads.
- Designed for use in extreme duty environments: heavy soils, larger tire diameter, Higher torque motors, and stronger gearboxes.
- Designed and tested under extreme loads to ensure coupler failure and prevent damage to gearbox.
- 20% increase in load carrying abilities.
- Urethane insert offers an environmentally stable insert with better resistance to UV rays and chemicals.
- Grooved insert option converts any coupler assembly for a towable application.
- UMC designed SQUEX bolts allow easy access to tighten nuts and creates unique bolt anti-rotation feature.
- 75,000 PSI high strength bolts and prevailing torque type nuts.
- High torque conditions compress inserts instead of shearing them.
- Shock attenuation insert allows for softer starts and stops.
- Ideal for high-torque, slow-speed conditions with severe back driving.
- Curved pressure pads compensate for out of line conditions.
- One year limited warranty.

UMC FINAL DRIVE WHEEL GEARBOX

725 SERIES - OUR MOST POPULAR MODEL

- 50:1 (725U) gear ratio
- 2-1/4" output shaft
- extended length hub design allows greater bearing spacing to accommodate higher load requirements

- dual input seals
- high strength cast iron bolt-on end caps
- universal multimount bolt pattern



T-N-T-2

- 50:1 (TNT-2-U), 52:1 (TNT-2-UV) gear ratios available
- 2-1/4" output shaft
- positive lock in both tow and non-tow positions

- easy to disengage for towing
- universal mount fits most systems
- lighter than standard towable units
- optional bronze gear



740 SERIES

- 50:1 (740U), 52:1 (740UV) gear ratios available
- 2-1/4" output shaft
- heavy-duty worm input bearings
- extra heavy-duty wheel gearbox for heavier towers

- larger diameter tires
- tested loads in excess of 125,000 in.-lbs.
- special crop guard seals on all shafts
- universal multimount bolt pattern



745 SERIES

- 50:1 (745U) gear ratio
- 2-1/2" output shaft
- high strength steel output shaft and forged worm

- input shaft guard included
- universal multimount bolt pattern
- available with towable hub



760 SERIES

- 50:1 (760U) gear ratio, 52:1 (760-UV) gear ratio available
- precision ground 2-1/2" output shaft
- dual output & input seal with external grease lube capabilities
- bolt pattern fits all pivots & lateral/linear systems

- static load tested in excess of 145,000 in.-lbs.
- includes A-110 bolt pattern
- full cycle expansion chamber
- optional bronze gear



Part No.	Description	Shaft Size	Gear Ratio	Type	Qty. 1-8	Qty. 9-35	36 (Pallet)
06147-105A	725-U Universal Gearbox	2-1/4" Short	50:1	Non-Tow			
10140-110-A	TNT-2-U Gearbox	2-1/4" Short	50:1	Towable			
10141-105A	740U Gearbox	2-1/4" Short	50:1	Non-Tow			
10141-106AD	740UV Gearbox	2-1/4" Extended	52:1	Non-Tow			
10140-116A	TNT-2-UV Gearbox	2-1/4" Extended	52:1	Towable			
10141-135A	745U Gearbox	2-1/2" Short	50:1	Non-Tow			
10160-109A	760-U Gearbox	2-1/2" Short	50:1	Non-Tow			
10160-106AD	760-UV Gearbox	2-1/2" Long	52:1	Non-Tow			

INTRO | 1. ELECTRICAL | 2. PUMP, ACC. | 3. HOSE, PE PIPE & ACC. | 4. IPS, PIP PIPE & ACC. | 5. SURFACE | 6. SPRINKLERS | 7. TRAVELER & WHEEL MOVE | 8. PIVOT | 9. TURF | 10. LOW VOLUME | 11. FILTERS | 12. INJECTION | 13. HARDWARE | INDEX

UMC TOWABLE HUB WITH PIN AND BRACKET ASSEMBLY

Towable Hub

- NEW: Extended length design provides greater bearing spacing, allowing for increased load requirements.
- Converts standard center pivot final drives into towables.
- Bearing pre-load is set using an SAE lock nut and washers.
- Heavy-Duty cast steel shaft and cast iron hub.
- Grease and pressure relief fittings included.
- Bolt-in hub cap secured with three 1/4-20 bolts and sealed with silicone RTV.



Pin Bracket Kit

- Designed to work with tow hubs & towable gearboxes.
- High strength pin to reduce wear.
- Heavy-Duty retainer clip.
- Fits standard eight bolt rim.

UMC BT-4B TOWABLE HUB WITH PIN AND BRACKET ASSEMBLY

To convert non-tow wheel gearboxes into towable units, also order:

Part No.	Description	Price
04301-114A	BT-4 Bolt-on Towable Hub	
04041-102A	Tow Pin & Bracket Assembly	
04041-204A	1" Clip Assembly	
04041-203A	6" Tow Pin Only	
04040-401A	Bracket Only	



UMC REPLACEMENT PARTS

These are the most commonly requested replacement parts for our UMC Final Drive Wheel Gearboxes. Other replacement parts, such as worm gears, bull gears, bearings, seals, etc., are available by special order and can be priced on request.

Part No.	Description	Price
06143-801A	Lug Bolt 9/16" - 18 x 1-5/8" Long	
04300-802A	Lug Bolt 9/16" - 18 x 1-7/8" Long	
06142-801A	Lug Nut 9/16" - 18	
06143-205D	Expansion Chamber Cover	
06143-704A	Expansion Chamber Diaphragm for 725U	



CENTER DRIVES & MOTORS

Power Saver 3.5:

Application: 460/380 Volt AC 60/50 Hz electric motors with 95% efficient helical spur gear speed reducing gearboxes for power transmission of electric drive center pivot / lateral move systems. Also used in power transmission for injection pump on chemical applicators.

Specifications:

- All aluminum gear case and motor housing for cooler running, longer life, and increased corrosion resistance.
- Proven reliability.
- Dual bolt mounting pattern 5" x 6", 3-3/8" x 6-3/8".
- Voltage: 460V 60 Hz, 380V 50 Hz.
- Type: Helical gear design. High strength steel shaft for long life and dependability.
- Thermally protected with automatic reset.
- All gears are heat treated.
- Shipped with gear oil.
- Specially designed input and output seals.
- Top fill plug positioned to set correct oil level.
- All critical electrical connections are encapsulated to resist penetration of moisture.
- Class F insulation and materials are used throughout.
- CSA approved.
- Efficiency 95%.
- Makes possible the use of smaller generators and smaller incoming wire sizes.



CENTER DRIVES & MOTORS

Center Drive:

Application: Speed reducing worm gearbox to be used in conjunction with electric motors for power transmission of electric drive center pivot / lateral move systems.

Specifications:

- Precision die cast tempered aluminum housing.
- Includes easy to install shock absorbing motor to gear box coupler.
- Accepts NEMA 56-C face motors with 5/8" shafts, 2" long with .19 key slots.
- Multiple mount plate bolt patterns 5" x 6"; 3-3/8" x 6-3/8".
- Ample oil fill, drain and level, threaded plug holes.
- Shipped with oil.
- High strength aluminum bronze bull gear.
- Includes special external crop guard seals.
- Painted for added corrosion resistance.



Electric Motor:

Application: 480/360 Volt AC electric motors to be used in conjunction with center drives for power transmission of electric drive center pivot / lateral move systems.

Specifications:

- All critical electrical connections are encapsulated to resist penetration of moisture.
- Specially designed to NEC and NEMA specs for rugged irrigation duty.
- 460/380 3 Phase, 60/50 HZ dual voltage, 1725 RPM (60 HZ), 1475 RPM (50 HZ).
- Thermally protected; automatic reset.
- Internal fin cooled.
- Heavy-Duty bearings.
- Designed for soft starts.
- High torque performance.
- CSA approved.
- Totally enclosed light weight easy to access top junction box.
- Minimal AMP draw: full load current at rated voltage, 2.3 AMPS.
- .625 shaft diameter with key and standard NEMA 56-C face bolt pattern.
- Class F rated insulation.
- One year limited warranty.
- Each motor hi-pot tested.



UMC CENTER DRIVE COMPONENTS

Part No.	Description	RPM's	1 - 4	5 & Up
09333-154A	56 C-Face Center Drive - 60:1	29		
09333-151A	56 C-Face Center Drive - 50:1	35		
09333-153A	56 C-Face Center Drive - 40:1	43		
09333-152A	56 C-Face Center Drive - 30:1	58		
06180-101A	1.5 HP C-Face Motor	1725		



UMC CENTER DRIVE POWER SAVER 3.5 GEARBOX WITH MOTOR

Part No.	Gear Ratio	Motor HP	Output	Full Load Amp	1 - 4	5 & Up
06168-101Q	60:1	3/4 HP	29 / 24 RPM	1.1 / 1.2 A		
06168-101H	50:1	3/4 HP	35 / 29 RPM	1.4 / 1.5 A		
06168-101A	40:1	3/4 HP	44 / 35 RPM	1.4 / 1.5A		
06168-101B	30:1	1.5 HP	58 / 48 RPM	2.2 / 2.3 A		
06168-101F	25:1	1.5 HP	68 / 56 RPM	2.2 / 2.3 A		
06168-101D	20:1	1.5 HP	87 / 71 RPM	2.2 / 2.3 A		



REPLACEMENT STATORS FOR POWER SAVERS

Part No.	Description	Price
06165-601G	Stator, .52 HP PS 3	
06160-604A	Stator, .75 HP PS 2	
06165-601A	Stator, .75 HP PS 3	
06168-601A	Stator, .75 HP PS 3.5	
06160-606B	Stator, 1.5 HP PS 2	
06165-601B	Stator, 1.5 HP PS 3	
06168-601B	Stator, 1.5 HP PS 3.5	



INTRO
 1. ELECTRICAL
 2. PUMP ACC.
 3. HOSE, PE PIPE & ACC.
 4. IPS, PIP PIPE & ACC.
 5. SURFACE
 6. SPRINKLERS
 7. TRAVELER & WHEEL MOVE
 8. PIVOT
 9. TURF
 10. LOW VOLUME
 11. FILTERS
 12. INJECTION
 13. HARDWARE
 INDEX

CENTER DRIVES & MOTORS

Product	HP	Gear Ratio	Output RPM	Model Number
Splined Gear Complete	1	58:1	30	7843
	1	47:1	37	A856
	1-1/2	31:1	56	A799
Motor Modules Splined	1		1750	A726
	1-1/2		1750	A728
Stator w/ Endbell	1		1750	G148
Stator Only	1		1750	F295
Stator Only	1		1750	F296
Gear Modules Splined		58:1	30	A732
		47:1	37	A730
		31:1	56	A800
C-Face Motors w/ Thermals	1		1750	5622
	1-1/2		1750	5624

U.S. ELECTRICAL MOTORS CENTER DRIVE COMPONENTS

Part No.	Description	Type	1 - 4	5 & Up
A726	1 HP Motor Module	Splined		
A728	1.5 HP Motor Module	Splined		
A732	58:1 Gear Module	Splined		
A730	47:1 Gear Module	Splined		
A800	31:1 Gear Module	Splined		
7843	58:1/1HP Complete	Splined		
A856	47:1/1 HP Complete	Splined		
A799	31:1/1.5 HP Complete	Splined		
F295	1 HP Stator 5.5" Frame	Splined		
F296	1 HP Stator 6.5" Frame	Splined		
G148	1 HP Stator w/Endbell	Splined		
768887	1 HP/1140 RPM Motor	Wheel		
5622	1 HP/1800 RPM Motor	C-Face		
5624	1.5 HP/1800 RPM Motor	C-Face		



BLUFFTON MOTOR WORKS (FORMERLY FRANKLIN ELECTRIC)

Part No.	Description	Type	1 - 4	5 & Up
UF12317	1-1/2 HP/1725 RPM Motor	C-Face		
UF17565	1 HP/1725 RPM Motor	C-Face		
UF17575	1 HP/1725 RPM Motor	Splined		



ELECTRICAL COMPONENTS & ACCESSORIES

STRAIN RELIEF CORD CONNECTORS

Part No.	Description	Price
CG1850S	1/2" MIPT Metal Cord Connector, .187-.312	
CG3775S	3/4" MIPT Metal Cord Connector, .375-.500	
CG50100S	1" MIPT Metal Cord Connector, .500-.625	
LPCG507	1/2" MIPT Plastic Cord Connector, .375-.750	
LPCG757	3/4" MIPT Plastic Cord Connector, .375-.750	
NMCG100875	1" MIPT Plastic Cord Connector, .750-.875	



FUSES

FLNR 250 VAC, FLQ 500 VAC & CCMR 600 VAC FUSES

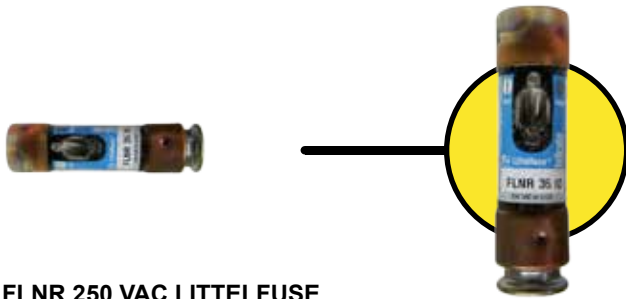

FLNR 250 VAC LITTELFUSE

Part No.	Description	Box Qty.	Price
FLNR4	250 VAC 4 AMP ID	10	
FLNR8	8 AMP	10	
FLNR10	10 AMP	10	
FLNR12	12 AMP	10	
FLNR15	15 AMP	10	
FLNR20	20 AMP	10	
FLNR25	25 AMP	10	
FLNR30	30 AMP	10	
FLNR35ID	250 VAC 35 AMP ID	10	
FLNR40ID	40 AMP	10	
FLNR45ID	45 AMP	10	
FLNR50ID	50 AMP	10	
FLNR60ID	60 AMP	10	
FLNR70ID	250 VAC 70 AMP ID	5	
FLNR80ID	80 AMP	5	
FLNR90ID	90 AMP	5	
FLNR100ID	100 AMP	5	
FLNR110ID	250 VAC 110 AMP ID	1	
FLNR150ID	150 AMP	1	
FLNR175ID	175 AMP	1	
FLNR200ID	200 AMP	1	
FLNR250ID	250 VAC 250 AMP ID	1	
FLNR300ID	300 AMP	1	

FLQ 500 VAC LITTELFUSE

Part No.	Description	Box Qty.	Price
FLQ.400	0.4 AMP	10	
FLQ1	1 AMP	10	
FLQ1.125	1-1/8 AMP	10	
FLQ1.25	1.25 Amp	10	
FLQ1.5	1.5 Amp	10	
FLQ2	2 AMP	10	
FLQ2.25	2.25 AMP	10	
FLQ2.5	2.5 AMP	10	
FLQ3	3 AMP	10	
FLQ3.2	3.2 AMP	10	
FLQ4	4 AMP	10	
FLQ5	5 AMP	10	
FLQ5.6	5.6 AMP	10	
FLQ6	6 AMP	10	
FLQ7	7 AMP	10	
FLQ8	8 AMP	10	
FLQ9	9 AMP	10	
FLQ10	10 AMP	10	
FLQ12	12 AMP	10	
FLQ15	15 AMP	10	
FLQ20	20 AMP	10	
FLQ25	25 AMP	10	
FLQ30	30 AMP	10	

GLASS BODY FUSES

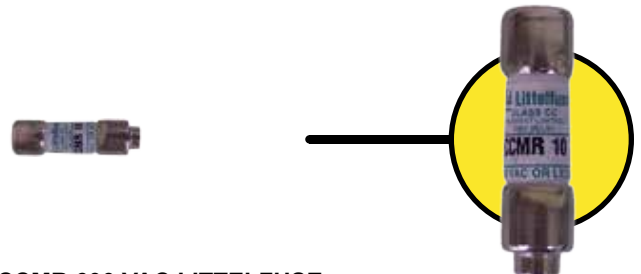

CCMR 600 VAC LITTELFUSE

Part No.	Description	Box Qty.	Price
CCMR001	1 AMP	10	
CCMR002	2 AMP	10	
CCMR002.5	2.5 AMP	10	
CCMR003	3 AMP	10	
CCMR003.2	3.2 AMP	10	
CCMR004	4 AMP	10	
CCMR005	5 AMP	10	
CCMR006	6 AMP	10	
CCMR008	8 AMP	10	
CCMR010	10 AMP	10	
CCMR012	12 AMP	10	
CCMR015	15 AMP	10	
CCMR17.5	17.5 AMP	10	
CCMR020	20 AMP	10	
CCMR025	25 AMP	10	
CCMR030	30 AMP	10	
CCMR080	80 AMP	10	

GLASS FUSE

Part No.	Description	Box Qty.	Price
03130.250VXP	1/4 AMP Glass Fuse		
03130.500VXP	1/2 AMP Glass Fuse		
03130.750VXP	3/4 AMP Glass Fuse		
031301.5VXP	1.5 AMP Glass Fuse		
0313002.VXP	2 AMP Glass Fuse		
031303.2VXP	3.2 AMP Glass Fuse		
0313004VXP	4 AMP Glass Fuse		
0313005.VXP	5 AMP Glass Fuse		

See Fuse Section Chart in section 14 for more information on choosing the correct fuses for your needs.

INTRO 1. ELECTRICAL 2. PUMP Acc. 3. HOSE, PE PIPE & Acc. 4. FPS, PIP Pipe & Acc. 5. SURFACE 6. SPRINKLERS 7. TRAVELER & WHEEL MOVE 8. PIVOT 9. TURF 10. LOW VOLUME 11. FILTERS 12. INJECTION 13. HARDWARE INDEX

FUSES

FLSR 600 VAC ID FUSES

JTD 600 VAC ID BOLT-IN FUSES



FLSR_ID 600 VAC LITTELFUSE

Part No.	Description	Box Qty.	Price
FLSR002ID	600 VAC 2 AMP ID	10	
FLSR02.5ID	2.5 AMP	10	
FLSR003ID	3 AMP	10	
FLSR004ID	4 AMP	10	
FLSR005ID	5 AMP	10	
FLSR05.6ID	5.6 AMP	10	
FLSR006ID	6 AMP	10	
FLSR007ID	7 AMP	10	
FLSR07.5ID	7.5 AMP	10	
FLSR008ID	8 AMP	10	
FLSR10ID	10 AMP	10	
FLSR12ID	12 AMP	10	
FLSR15ID	15 AMP	10	
FLSR17ID	17 AMP	10	
FLSR17.5ID	17.5 AMP	10	
FLSR20ID	20 AMP	10	
FLSR25ID	25 AMP	10	
FLSR30ID	30 AMP	10	
FLSR35ID	600 VAC 35 AMP ID	10	
FLSR40ID	40 AMP	10	
FLSR45ID	45 AMP	10	
FLSR50ID	50 AMP	10	
FLSR60ID	60 AMP	10	
FLSR70ID	600 VAC 70 AMP ID	5	
FLSR80ID	80 AMP	5	
FLSR90ID	90 AMP	5	
FLSR100ID	100 AMP	5	
FLSR110ID	600 VAC 110 AMP ID	1	
FLSR125ID	125 AMP	1	
FLSR150ID	150 AMP	1	
FLSR175ID	175 AMP	1	
FLSR200ID	200 AMP	1	
FLSR225ID	600 VAC 225 AMP ID	1	
FLSR250ID	250 AMP	1	
FLSR300ID	300 AMP	1	
FLSR350ID	350 AMP	1	
FLSR400ID	400 AMP	1	

JTD_ID 600 VAC (BOLT-IN) LITTELFUSE

Part No.	Description	Box Qty.	Price
OJTD-15-TXID	600 VAC 15 AMP ID	10	
OJTD-20-TXID	20AMP	10	
OJTD-25-TXID	25 AMP	10	
OJTD-30-TXID	30 AMP	10	
OJTD-35-TXID	600 VAC 35 AMP ID	10	
OJTD-40-TXID	40AMP	10	
OJTD-45-TXID	45 AMP	10	
OJTD-50-TXID	50 AMP	10	
OJTD-60-TXID	60 AMP	10	
OJTD-70-VXID	600 VAC 70AMP ID	5	
OJTD-80-VXID	80 AMP	5	
OJTD-90-VXID	90 AMP	5	
OJTD-100-VXID	100 AMP	5	
OJTD-110-XXID	600 VAC 110AMP ID	1	
OJTD-125-XXID	125 AMP	1	
OJTD-150-XXID	150 AMP	1	
OJTD-175-XXID	175 AMP	1	
OJTD-200-XXID	200 AMP	1	
OJTD-225-XXID	600 VAC 225 AMP ID	1	
OJTD-250-XXID	250 AMP	1	
OJTD-300-XXID	300 AMP	1	
OJTD-350-XXID	350 AMP	1	
OJTD-400-XXID	400 AMP	1	

See Fuse Section Chart in section 14 for more information on choosing the correct fuses for your needs.

TRANSFORMERS

Part No.	Description	Price
9T58K3314	GE Transformer .530KVA 480/120,29 VAL 314977, ZIM 9-7666-2	
9T58K0049	GE Transformer .375 KVA 480/120 LW L-844-4	
9070T500Q28711	SQUARE D Transformer .5KVA 460/120, 29 VAL 314977, ZIM 9-7666-2	
9070T500Q31053	SQUARE D Transformer .5KVA 460/120 VAL 03E1540	
598	EDWARDS Transformer 120/ 8, 16, 24 20VA-30VA	
B050BTZ13JK	Micron Transformer 50VA 230X460/115	

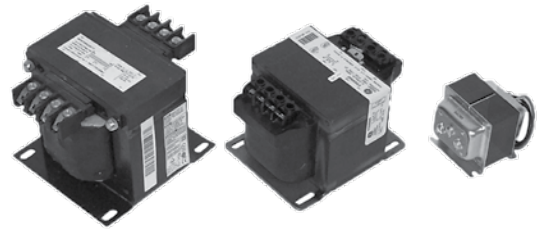

PRESSURE SWITCHES AND PANEL METERS

Part No.	Description	Price
HZ19K964001	ASCO® Pressure Switch - ZIM, LW 6-90 PSI	
HZ19K965003	ASCO® Pressure Switch w/Enclosure, LW 3-35 PSI	
250344SJSJ	GE/Yokogawa Voltmeter, 600V AC (Square)	
T50B2	ENM Hour Meter, 115V	
E1S-H15-Q52	Barksdale Pressure Switch .15-15PSI, VAL 0315994	

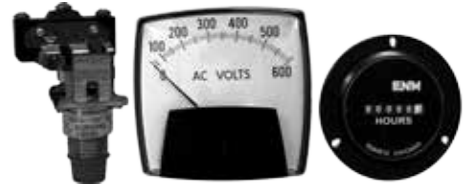

LIMIT SWITCHES, ACTUATORS & TOGGLE SWITCHES

Part No.	Description	Price
LSD3K	Limit Switch, Roller Plunger Head	
LSA3K	Limit Switch, Dbl, Brake, SPDT	
LSA3K8A	Limit Switch, Whisker	
LSQ300	Limit Switch, Windmill 360°, SPDT	
LSZ54N	Actuator Rod	
LSZ69DA	Windmill Actuator Rod	
LSZ51B	Roller Lever	
900003	Toggle Switch On/Off, SPST	
7592K8	Toggle Switch On/On, DPDT	
1121-0014	Toggle Switch Off/On, DPDT, Spring Return	
7563K6	Toggle Switch On/Off/On, DPDT, 3 Position	
CA11-C13064*E	Tower Disconnect, 600V, American Solenoid	



PERCENTAGE AND OVERWATERING TIMERS

Part No.	Description	Price
HQ4E02S48A6	Eagle 30 Sec. Percentage Timer	
HQ4E03S48A6	Eagle 60 Sec. Percentage Timer	
304GX400Q00XX	ATC Multi-range Percentage Timer	
322B014A12CS	ATC 10 Min., Overwatering, End Shut Down	
322B014A22CS	ATC 10 Min., Overwatering, Stall, End Shut Down	
BRE232A6	Overwatering Timer, 60 Min, Eagle Signal	
BRE7A601	Solid State Reversing Reset Timer, 5 Min	
BRE8A601	Solid State Reversing Reset Timer, 10 Min	
BRE9A601	Solid State Reversing Reset Timer, 30 Min	
BRE10A601	Solid State Reversing Reset Timer, 60 Min	



MICRO SWITCHES

Part No.	Item	Description	Price
BZ-7RW80189-A2	1	MS, Short Arm Cam, LW L-640-076	
BZ-2RW80147-P4	2	MS, Short Arm Cam, Side Terminal LW L640-00063	
BZ-2RW80147-A2	3	MS, Short Arm Cam Old Lockwood L640-00148	
BZ-2RQ18-A2	4	MS, Plunger, Roller VAL 314893, ZIM, LW	
BZ-3RW8995516-PC2-S	5	MS, Short Arm Roller, Adj. Screw VAL 314905 (Replacement)	
BZ-7RW82132T-S	6	MS, Long Arm Roller, ZIM 9-9030-9	
BZ-7RW2T04	7	MS, Long Arm Roller, Pierce	
BZ-2RW822-A2	8	MS, Short Arm Roller Gifford Hill, Tumac	
BZ-3RW822-A2	9	MS, Short Arm Roller, Hydrus	
BZ-2RW82255-A2-S	10	MS, Short Arm Roller, Reinke, Tumac	
BZ-2RW8255-A2-S1	11	MS, Long Arm Roller, Zim Mini	

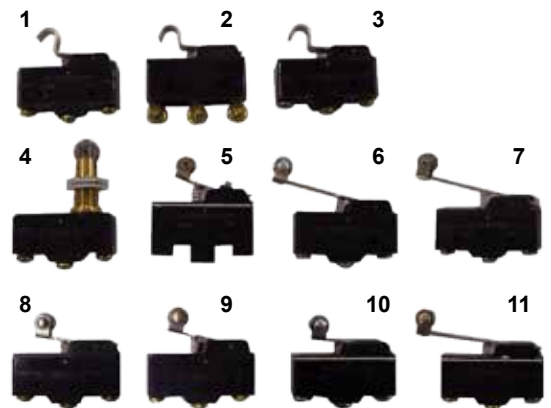

INTRO
 1. ELECTRICAL
 2. PUMP Acc.
 3. HOSE, PE PIPE & Acc.
 4. IPS, PIP PIPE & Acc.
 5. SURFACE
 6. SPRINKLERS
 7. TRAVELER & WHEEL MOVE
 8. PIVOT
 9. TURF
 10. LOW VOLUME
 11. FILTERS
 12. INJECTION
 13. HARDWARE
 INDEX

RELAYS

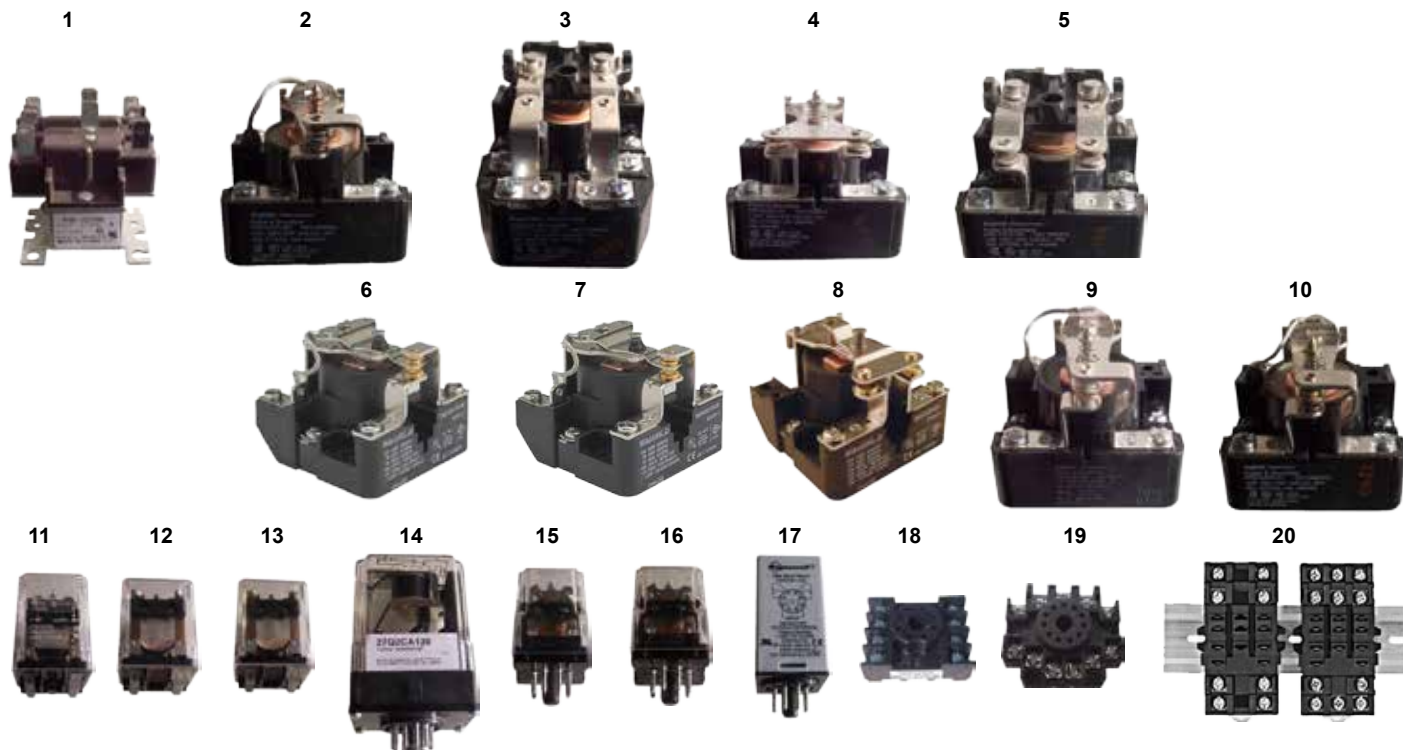

RELAYS

Part No.	Item	Description	Price
9100233T99	1	PU GENERAL PURPOSE RELAY, DPDT, 120 VAC	
PRD5AYO480	2	P & B POWER RELAY, SPDT, 480VAC 50/60 HZ 25A 277VAC 1HP 120VAC 2HP 250VAC 10A 600VAC 7A 50VAC RESISTIVE	
PRD11AGO120VAC	3	P & B POWER RELAY, DPDT, 120VAC 50/60HZ 30A 240VAC 20A 277VAC 10A 600VAC VAL 314727	
PRD3AGO120	4	P & B POWER RELAY, SPST, 120 VAC 50/60HZ, 30 A 277VAC RESISTIVE, 1.5HP 120VAC, 2 HP 250VAC, 10 AMP 600VAC	
PRD7AYO120VAC	5	P & B POWER RELAY, DPST, 1HP - 120VAC 25A 240VAC 50/60HZ - ZIM9-9179-4	
8501CO15V20	6	Square D RELAY, 600VAC 5AMP Type C +Options 1-Phase, 30A, SPDT, 120VAC@50/60Hz, 1-1/2HP	
8501CO15V14	7	Square D RELAY, 600VAC 5AMP Type C +Options 1-Phase, 30A, SPDT, 24VAC@50/60Hz, 1-1/2HP	
8501CO6V20	8	Square D RELAY, 120VAC 5AMP Type C +Options, 1-Phase, 30A, SPST, 120VAC@50/60Hz, 1-1/2HP	
PRD5AYO120VAC	9	P & B POWER RELAY, SPDT, 120 VAC 50/60 HZ 25A 277VAC 10A 600VAC - ZIM 9-9142-2M	
PRD5AYO24VAC	10	P & B POWER RELAY SPDT, 24VAC 50/60HZ 25A 277VAC 10A 240VAC - ZIM 9-8890-7	
KUL11A15S120VAC	11	P & B ICE CUBE RELAY, 9 BLADE, 120VAC 50/60HZ 25A 277VAC 10A 600VAC - ZIM 10-0161-9	
KUP11D15110VDC	12	P & B ICE CUBE RELAY, 8 BLADE, 110VDC 3A 600VAC 10A 240VAC - VAL 315559	
KUP11D1512VDC	13	P & B ICE CUBE RELAY, 8 BLADE, 12 VDC COIL 1/3HP 120VAC 10A 240VAC, VAL 099PO16, LW40-741	
27Q2CA120	14	Eagle LATCHING RELAY, 11PIN - 120V 50/60 HZ 10A 120VAC RESISTIVE - ZIM 9-8955-8	
KRPA11AN024VAC	15	P & B ICE CUBE RELAY, 8 PIN, 24VAC 50/60HZ 1/3HP 120VAC 1/2HP 10A 240VAC	
KRPA11AN120VAC	16	P & B ICE CUBE RELAY, 8 PIN, 120V 50/60 HZ 1/3HP 120VAC 1/2HP 10A 240VAC	
TDRSOXP120V	17	Magnecraft Time Delay Relay, 8 Pin, 120VAC/VDC Input Timing Range: 0.1 Sec to 10 Hrs. Contacts: 1/3HP 120VAC, 1/2HP 240VAC, 12A 120/240VAC 30VDC	
OT08PC	18	Custom Connector Socket, 8 Pin	
OT11PC	19	Custom Connector Socket, 11 Pin	
ST11PC	20	Custom Connector Socket, 11 Blade Works with 8 or 11 Blades	

CONTACTORS



CUTLER HAMMER CONTACTORS

Part No.	Item	Description	Price
C320KG3	1	1-NO,1-NC Aux Contact for 15-75 AMP C25 Contactor, Stackable	
C25DND325A	2	Cutler Hammer 3 Pole Non-reversing Contactors, 25A, 110 - 120VAC	
C25DND330A	3	30 AMP 3-Pole Tower Contactor 120V	
C25DND330C	4	30 AMP 3-Pole Tower Contactor 480V	
C25DND340A	5	40 AMP 3-Pole Tower Contactor 120V	
C25ENC430A	6	30 AMP 4-Pole Panel Contactor 120V	

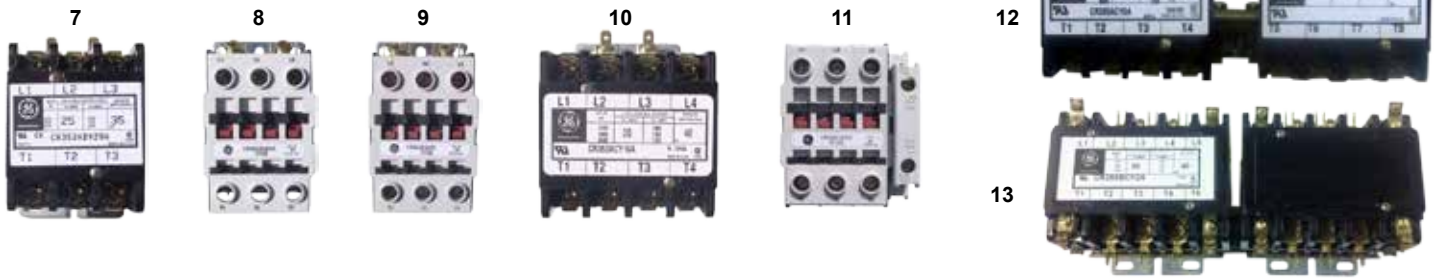

GE CONTACTORS

Part No.	Item	Description	Price
CR353ABY29A	7	GE 3 Pole Tower Contactor, 120VAC, 25 FL AMPS VAL 314667, ZIM 9-0866-5, LW L-40-246	
CR453AB3AMMP	8	GE 3 Pole Tower Contactor, 120VAC, 25 FL AMPS (New Style) VAL 314667, ZIM 9-0866-5, LW L-40-246	
CR453AC3ADDP	9	GE 3 Pole W/Lugs Contactor, 120VAC, 30 FL AMPS (Replaces CR353AC3DA1) VAL 314598, LW L-40-602	
CR353ACY16A	10	GE 4 Pole Panel Contactor, 120 VAC, 30 FL AMPS VAL 99P013, ZIM 9-0860-8	
CR453AC3ADDP W/ BCLL11	11	GE 4 Pole Panel Contactor, 120VAC (Replaces CR353ACY16A) Add BCLL11 Side Mount Auxiliary Contact VAL 99P013, ZIM 9-0860-8	
EB340R	12	GE 4-POLE REVERSER CR355ACY6A (OLD STYLE)	
EB430R	13	GE 3-POLE REVERSER W/AUX CR355BCY2A (OLD STYLE)	
CR455AC3AMMD22FP	14	GE 4 Pole Reversing Contactor, 120VAC, 30 FL AMPS (Replaces CR355ACY7A) ZIM 9-0864-0	
CR353XAAA	15	GE 353 Series Side Mount Auxiliary Contact Block, 1NO - 1NC	
BCLF10	16	GE 453 Series Front Mount Auxiliary Contact Block, 1NO	
BCLF01	17	GE 453 Series Front Mount Auxiliary Contact Block, 1NC	
BCLL11	18	GE 453 Series Side Mount Auxiliary Contact Block, 1NO-1NC	
BCLL20	19	GE 453 Series Side Mount Auxiliary Contact Block, 2NO	



SQUARE D CONTACTORS

Part No.	Item	Description	Price
8910DPA23V02	20	SD 25 AMP 3-Pole Tower Contactor 120V Thin Metal Base	
8910DPA33V02	21	SD 30 AMP 3-Pole Tower Contactor 120V Thin Metal Base	
8910DPA23S31	22	SD 3 Pole Tower Contactor, 120VAC, 25 FL AMPS, ZIM 9-0866-5	
8910DPA34S31	23	SD 4 Pole Panel Contactor, 120VAC, 30 FL AMPS, ZIM 9-0860-8	
8910DPA44S41	24	SD 4 Pole Panel Contactor, 120VAC, 40 FL AMPS, VAL 3E1848	

INTRO | 1. ELECTRICAL | 2. PUMP Acc. | 3. HOSE, PE PIPE & Acc. | 4. FPS, PIP Pipe & Acc. | 5. SURFACE | 6. SPRINKLERS | 7. TRAVELER & WHEEL MOVE | 8. PIVOT | 9. TURF | 10. LOW VOLUME | 11. FILTERS | 12. INJECTION | 13. HARDWARE | INDEX

COLLECTOR RING AND ELECTRICAL ACCESSORIES

COLLECTOR RING

11 Wire Collector Ring

Replacements for all brands except ZIMMATIC®

Part No.	Description	Price
4011	UL Approved Titan Economical Collector Ring	
CA13235-11-LG	Insul 8 UL Approved (Room for Resolver Capability)	



DELTA LIGHTNING ARRESTOR

Part No.	Description	Price
LA 301	125-250 Volt Single Phase 2 Wire Service	
LA 302	125-250 Volt Single Phase 3 Wire Service	
LA 302R	Light Duty 125-250 Volt Single Phase 3 Wire Service	
LA 303	250 Volt 3 Phase 3 or 4 Wire Service	



SUPPRESSOR, RECTIFIER, LIGHTNING ARRESTOR & HEATER

Part No.	Description	Price
STB02113265	Forked Arc Suppressor	
58K8886	Rectifier, LWL-40-740	
LA603MB	Delta Lightning Arrester, 3 Pole 0-650V	
123C356A	GE Overload Heater	



ALIGNMENT WIRE & ACCESSORIES

Part No.	Item	Description	Price
13GA1400FT	1	13 Gauge Wire - 1400' Reel (LW)	
L0003200217	2	1.5" x 26" Alignment Spring	
L0003200242	3	2.5" Spring for Alignment Wire	
L0004400319	4	Thimble 1/8" Safety & Alignment	
L0012100061	5	Ring, Spring Safety & Damper	
L0020300090	6	Center Bearing for Alignment Wire	
L0010100191	7	Fixing Nut for Alignment Wire	
L0004000463	8	Split Bolt Connector Safety Wire	
L0004000164	9	Insulator for Alignment Wire	



MISCELLANEOUS



PIVOT PIPE GASKET

Part No.	Item	Description	Price
658TG	1	6-5/8" Pivot Pipe Flange Gasket	
L0091000057	2	Lockwood 6-5/8" Pivot Flange Gasket	
VP6	3	Valmont 6" Flange Gasket	
VP658	3	Valmont 6-5/8" Flange Gasket	
VP8	3	Valmont 8" Flange Gasket	
LIN-Gasket-5-9/16	4	Lindsay Flange Pipe Gasket 5-9/16"	
LIN-Gasket-6-5/8	4	Lindsay Flange Pipe Gasket 6-5/8"	
LIN-Gasket-8	4	Lindsay Flange Pipe Gasket 8"	

NETIRRIGATE®

All NETB13 SKUs have the following features:

- No monthly or annual subscription fees.* (except NetB13WRXP)
- One part provides instant cellular connectivity to the CDMA or GSM network.
- No base station or line of sight requirements.
- One year manufacturer's warranty on parts.
- Event driven voice, text, and email messages.
- User friendly computer interface + mobile applications.



Part No. / SKU	Name	Description	Network Options
NETB13WRXP	WireRat® Express	Stand-alone span cable alarm system with simple installation	CDMA
NETB13PIV	PivotProxy™ with WireRat® technology	Detect span cable theft, and monitor and control electrically driven pivots	CDMA or GSM
NETB13TL	PivotProxy™ TL	Monitor and control T-L® branded pivots	CDMA
NETB13PPAC	PumpProxy® AC with WireRat® technology	Remotely control and monitor electrically powered pumps and receive on/off notifications	CDMA
NETB13PPDC	PumpProxy® DC	Remotely shutdown and monitor engine driven pumps and receive on/off notifications	GSM

Features	WRXP	PIV	TL	PPAC	PPDC
No monthly / annual fees		•	•	•	•
Remote shutdown		•	•	•	•
Remote start				•	
WireRat technology	•	•		•	
GPS and virtual stop-in-slot		•	•		
Mobile Applications	•	•	•	•	•
Notifications	WRXP	PIV	TL	PPAC	PPDC
Copper wire theft alerts	•	•		•	
Now running / pumping notifications		•	•	•	•
Stopped running / pumping notifications		•	•	•	•
Virtual stop-in-slot notifications		•	•		

Advantages of WireRat® 3.0 Technology

- Reduced False Alarms
- Simpler Installation
- Improved Security
- Increased Battery life



NETB13WRXP (WIRERAT® EXPRESS)

Price Level	Order Qty	Price
0	< 8	
1	> = 8	
2	> = 16	
3	> = 24	

Stand-alone span cable alarm system

The WireRat® Express is ideal for customers who are interested only in span cable protection. It also serves as a compliment to alternative remote pivot monitoring solutions. The WireRat® Express works seamlessly with all brands of electrically-driven center pivots.

NETB13PIV* (PIVOTPROXY™)

with WireRat® technology

Price Level	Order Qty	Price
0	< 8	
1	> = 8	
2	> = 16	
3	> = 24	

For electrically driven pivots (90-240VAC control circuits).

The PivotProxy® provides comprehensive pivot monitoring and security. The PivotProxy works seamlessly with all brands of electrically driven center pivots.

*Works on the CDMA network.



NETB13PIV - GSM* (PIVOTPROXY™)

with WireRat® technology

Price Level	Order Qty	Price
0	< 8	
1	> = 8	
2	> = 16	
3	> = 24	

For electrically driven pivots (90-240VAC control circuits).

The PivotProxy® provides comprehensive pivot monitoring and security. The PivotProxy works seamlessly with all brands of electrically driven center pivots.

*Works on the GSM network.



NETB13TL (PIVOTPROXY™ TL)

Price Level	Order Qty	Price
0	< 8	
1	> = 8	
2	> = 16	
3	> = 24	

For T-L branded pivots (12-24 volt AC or DC control circuits).

A flexible and cost-effective solution for adding safety stop notifications, remote shutdown capabilities, and GPS monitoring to T-L branded pivots. Support for both full circle and auto reverse T-L pivots.



Note: for the NetIrrigate Pump Proxy, please refer to page 2:3.

NITRO
 1. ELECTRICAL
 2. PUMP Acc.
 3. HOSE, PE PIPE & Acc.
 4. IPS, PIP Pipe & Acc.
 5. SURFACE
 6. SPRINKLERS
 7. TRAVELER & WHEEL MOVE
 8. PIVOT
 9. TURF
 10. LOW VOLUME
 11. FILTERS
 12. INJECTION
 13. HARDWARE
 INDEX

STROBE LIGHTS

TOMAR PIVOT STROBE LIGHTS

485 MICRO STROBE LIGHT EFFECTIVE CANDELA 50

Part No.	Description	Price
485S-A	1.75J Strobe Amber 120V	
485S-B	1.75J Strobe Blue 120V	
485S-C	1.75J Strobe Clear 120V	
485S-G	1.75J Strobe Green 120V	
485S-P	1.75J Strobe Purple 120V	
485S-R	1.75J Strobe Red 120V	
5001	Replacement Bulb	
470S-L	Replacement Lens	
Flash / Minute 60-80 Connection Screw in Socket		



801 MINI I STROBE LIGHT EFFECTIVE CANDELA 400

Part No.	Description	Price
801-110-A	8 J Strobe Amber 120V	
801-110-B	8 J Strobe Blue 120V	
801-110-C	8 J Strobe Clear 120V	
801-110-G	8 J Strobe Green 120V	
801-110-P	8 J Strobe Purple 120V	
801-110-R	8 J Strobe Red 120V	
801-1274-A	8 J Strobe 12-74VDC	
801-1274-C	8 J Strobe 12-74VDC	
4001	Replacement Bulb for T801	
801S-L	Replacement Lens	
Available in VDC Flash / Minute 80-90 Connection 1/2" FPT		



490 MICRO STROBE LIGHT EFFECTIVE CANDELA 50

Part No.	Description	Price
490S-A	1.75J Strobe Amber 120V	
490S-B	1.75J Strobe Blue 120V	
490S-C	1.75J Strobe Clear 120V	
490S-G	1.75J Strobe Green 120V	
490S-P	1.75J Strobe Purple 120V	
490S-R	1.75J Strobe Red 120V	
5001	Replacement Bulb	
470S-L	Replacement Lens	
Flash / Minute 60-80 Connection 1/2" FPT with leads		



824 MULTI PULSE STROBE LIGHT EFFECTIVE CANDELA 1200

Part No.	Description	Price
824-110-A	23 J Strobe Amber 120V	
824-110-B	23 J Strobe Blue 120V	
824-110-C	23 J Strobe Clear 120V	
824-110-G	23 J Strobe Green 120V	
824-110-P	23 J Strobe Purple 120V	
824-110-R	23 J Strobe Red 120V	
4001	Replacement Bulb	
1700	Replacement Lens	
Flash / Minute 120-240 Connection 1/2" FPT		



CODE 3® PIVOT STROBE LIGHTS



LL1HD ULTRA LITE® STROBE LIGHT EFFECTIVE CANDELA 230

Part No.	Description	Price
L1001ATH	4 Joule HD Strobe 110VAC Amber	
L1001BTH	4 Joule HD Strobe 110VAC Blue	
L1001CTH	4 Joule HD Strobe 110VAC Clear	
L1001GTH	4 Joule HD Strobe 110VAC Green	
L1001RTH	4 Joule HD Strobe 110VAC Red	
LL1-PMK	3/4" FPT Pipe Mount Kit	
T15597	Replacement Bulb	
LL2-#L-LP	Replacement Lens Specify Color	
Flash / Minute 30 Connection 3/4" FPT		



LL8HD ASTRO FLASH® STROBE LIGHT EFFECTIVE CANDELA 575

Part No.	Description	Price
L8001ATH	15 Joule HD Strobe 110VAC Amber	
L8001BTH	15 Joule HD Strobe 110VAC Blue	
L8001CTH	15 Joule HD Strobe 110VAC Clear	
L8001GTH	15 Joule HD Strobe 110VAC Green	
L8001RTH	15 Joule HD Strobe 110VAC Red	
T13074	Replacement Bulb	
T130**	Replacement Lens Specify Color	
Flash / Minute 72 Connection 3/4" FPT		

** - 57 Amber, 58 Blue, 59 Clear, 60 Green, 62 Red

Call for Volume Pricing

BOOT HOSE

NOVAFLEX 2150 BOOT HOSE 2PLY

Part No.	Size	T-Bolt Size	Working PSI	Price / Ft.	Price / 100 Ft.
2150BE-04500-00	4-1/2"	0488	100		
2150BE-05000-00	5"	0525	100		
2150BE-05563-00	5-9/16"	0600	100		
2150BE-06000-00	6"	0625	85		
2150BE-06625-00	6-5/8"	0706	75		
2150BE-08000-00	8"	0844	75		
2150BE-08625-00	8-5/8"	0918	75		
2150BE-10000-00	10"	1044	75		



KURIYAMA T253AA BOOT HOSE 2 PLY 150 PSI

Part No.	Size	T-Bolt Size	Price / Ft.	Price / 100 Ft.
T253AA150X100	1-1/2"	0175		
T253AA200X100	2"	0238		
T253AA300X100	3"	0350		
T253AA400X100	4"	0425		
T253AA600X100	6"	0644		
T253AA662X100	6-5/8"	0706		
T253AA800X100	8"	0844		
T253AA1000X100	10"	1062		
T253AA1200X50	12"	DB1275		



Note: 12" is priced for 50 Ft. Roll. 12" Rated for 100 PSI

PARKER BOOT HOSE 4 PLY 150 PSI

Part No.	Size	T-Bolt Size	Price / Ft.	Price / 50 Ft.
SA7855560	5-9/16"	0618		
SA7856000	6"	0656		
SA7856625	6-5/8"	0725		
SA7858000	8"	0862		
SA7858625	8-5/8"	0918		



Note: Additional Hose Selection Located in Section 3

CLAMPCO T-BOLT CLAMPS

Part No.	Reference No.	Size	Clamping Range		Price
95130-0488	TBC-4-0488	4-1/2"	4.63"	5.03"	
95130-0525	TBC-5-0525	5"	5.00"	5.40"	
95130-0600	TBC-5916-0600	5-9/16"	5.75"	6.15"	
95130-0618	TBC-6-0618	6"	5.93"	6.33"	
95130-0650	TBC-6.5-0650	6"	6.25"	6.65"	
95130-0656	TBC-6.5-0656	6"	6.31"	6.71"	
95130-0706	TBC-6.62-0706	6-5/8"	6.81"	7.21"	
95130-0712	TBC-6.62-0712	6-5/8"	6.87"	7.27"	
95130-0725	TBC-6.62-0725	6-5/8"	7.00"	7.40"	
95130-0856	TBC-8.5-0856	8"	8.31"	8.71"	
95130-0862	TBC-8-0862	8"	8.37"	8.77"	
95130-0918	TBC-858-0918	8-5/8"	8.93"	9.33"	
95130-1062	TBC-10-1062	10"	10.37"	10.77"	



Note: Additional T-Bolt Clamp Selection Located on page 3:47.

Also refer to page 14:7 for Hose & Clamp Section Guide.

NATIONAL FINE NYLON LOCK NUT

Part No.	Description	Price
NLN5/1624	5/16" Replacement Lock Nut for 95130 Series T-Bolt Clamp	



TITAN® NEW TIRES, GALVANIZED WHEELS, TUBES AND ASSEMBLIES

TITAN® NEW TIRES

Part No.	Size	Description	Price
473404	11.2 x 24	Titan Hi - Power Lug R-1 Tire 4 Ply Tube Type	
473434	14.9 x 24	Titan Hi - Power Lug R-1 Tire 4 Ply Tube Type	
473634	14.9 x 24	Titan Hi - Power Lug R-1 Tire 6 Ply Tube Type	
473408	11.2 x 38	Titan Hi - Power Lug R-1 Tire 4 Ply Tube Type	
483408	11.2 x 38	Titan Hi - Power Lug R-1 Tire 4 Ply Tubeless	
483608	11.2 x 38	Titan Hi - Power Lug R-1 Tire 6 Ply Tubeless	



TITAN® GALVANIZED WHEELS

Part No.	Size	Description	Price
041958300013	8 x 24	Galvanized Wheel for 11.2 x 24	
050761600013	10 x 24	Galvanized Wheel for 11.2 x 24 & 14.9 x 24	
050803900013	12 x 24	Galvanized Wheel -2° Offset for 14.9 x 24	
050777200013	12 x 24	Galvanized Wheel 0° Offset for 14.9 x 24	
051992500013	10 x 38	Galvanized Wheel for 11.2 x 38 - Single Plate	
051992600013	10 x 38	Galvanized Wheel for 11.2 x 38 - Double Plate	
051993400013	10 x 38	Galvanized Wheel for 11.2 x 38 - 9 Hole TL	



TITAN® TUBES FOR NEW TIRES

Part No.	Size	Description	Price
3FM03	11.2 x 24	Tube for 11.2 x 24 Tire	
3FE04	14.9 x 24	Tube for 14.9 x 24 Tire	
3FE60	11.2 x 38	Tube for 11.2 x 38 Tire	



TITAN® TIRE & WHEEL ASSEMBLIES

Part No.	Size	Description	Price
473404-8W-TB	11.2 x 24	11.2 x 24 4 Ply Tire / 8 x 24 Wheel / Tube	
473404-10W-TB	11.2 x 24	11.2 x 24 4 Ply Tire / 10 x 24 Wheel / Tube	
473434-10W-TB	14.9 x 24	14.9 x 24 4 Ply Tire / 10 x 24 Wheel / Tube	
473434-122W-TB	14.9 x 24	14.9 x 24 4 Ply Tire / 12 x 24 -2° OS Wheel / Tube	
473434-12ZW-TB	14.9 x 24	14.9 x 24 4 Ply Tire / 12 x 24 ZO Wheel / Tube	
473634-10W-TB	14.9 x 24	14.9 x 24 6 Ply Tire / 10 x 24 Wheel / Tube	
473634-122W-TB	14.9 x 24	14.9 x 24 6 Ply Tire / 12 x 24 -2° OS Wheel / Tube	
473634-12ZW-TB	14.9 x 24	14.9 x 24 6 Ply Tire / 12 x 24 ZO Wheel / Tube	
473408-SP-TB	11.2 x 38	11.2 x 38 4 Ply Tire / 10 x 38 SP Wheel / Tube	
47340-DP-TB	11.2 x 38	11.2 x 38 4 Ply Tire / 10 x 38 DP Wheel / Tube	
473408-TL-TB	11.2 x 38	11.2 x 38 4 Ply Tire / 10 x 38 TL Wheel / Tube	
483408-SP-TL	11.2 x 38	11.2 x 38 4 Ply Tire / 10 x 38 SP Wheel / Tubeless	
483408-DP-TL	11.2 x 38	11.2 x 38 4 Ply Tire / 10 x 38 DP Wheel / Tubeless	
483408-TL-TL	11.2 x 38	11.2 x 38 4 Ply Tire / 10 x 38 TL Wheel / Tubeless	
483608-SP-TL	11.2 x 38	11.2 x 38 6 Ply Tire / 10 x 38 SP Wheel / Tube	
483608-DP-TL	11.2 x 38	11.2 x 38 6 Ply Tire / 10 x 38 DP Wheel / Tube	
483608-TL-TL	11.2 x 38	11.2 x 38 6 Ply Tire / 10 x 38 TL Wheel / Tube	
483608-SP-TB	11.2 x 38	11.2 x 38 6 Ply Tire / 10 x 38 SP Wheel / Tubeless	
483608-DP-TB	11.2 x 38	11.2 x 38 6 Ply Tire / 10 x 38 DP Wheel / Tubeless	
483608-TL-TB	11.2 x 38	11.2 x 38 6 Ply Tire / 10 x 38 TL Wheel / Tubeless	



GOODYEAR TIRES, GALVANIZED WHEELS, TUBES AND ASSEMBLIES

GOODYEAR NEW TIRES

Part No.	Size	Description	Price
4DQ404GY	11.2 x 24	11.2 x 24 Dura Torque 4 Ply Tubeless	
4DQ434GY	14.9 x 24	14.9 x 24 Dura Torque 4 Ply Tubeless	
4DQ408GY	11.2 x 38	11.2 x 38 Dura Torque 4 Ply Tubeless	



TITAN® GALVANIZED WHEELS

Part No.	Size	Description	Price
041958300013	8 x 24	Galvanized Wheel for 11.2 x 24	
050761600013	10 x 24	Galvanized Wheel for 11.2 x 24 & 14.9 x 24	
050803900013	12 x 24	Galvanized Wheel -2° Offset for 14.9 x 24	
050777200013	12 x 24	Galvanized Wheel 0° Offset for 14.9 x 24	
051992500013	10 x 38	Galvanized Wheel for 11.2 x 38 - Single Plate	
051992600013	10 x 38	Galvanized Wheel for 11.2 x 38 - Double Plate	
051993400013	10 x 38	Galvanized Wheel for 11.2 x 38 - 9 Hole TL	



TITAN® TUBES FOR NEW TIRES

Part No.	Size	Description	Price
3FM03	11.2 x 24	Tube for 11.2 x 24 Tire	
3FE04	14.9 x 24	Tube for 14.9 x 24 Tire	
3FE60	11.2 x 38	Tube for 11.2 x 38 Tire	

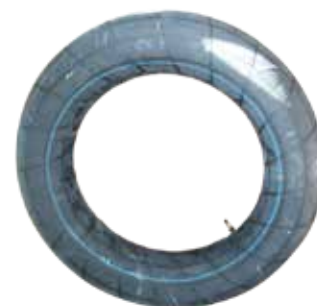

GOODYEAR TIRE & WHEEL ASSEMBLIES

Part No.	Size	Description	Price
4DQ404GY-8W-TL	11.2 x 24	11.2 x 24 4 Ply Tire / 8 x 24 Wheel / Tubeless	
4DQ404GY-8W-TB	11.2 x 24	11.2 x 24 4 Ply Tire / 8 x 24 Wheel / Tubeless	
4DQ404GY-10W-TL	11.2 x 24	11.2 x 24 4 Ply Tire / 10 x 24 Wheel / Tubeless	
4DQ404GY-10W-TB	11.2 x 24	11.2 x 24 4 Ply Tire / 10 x 24 Wheel / Tube	
4DQ434GY-10W-TL	14.9 x 24	14.9 x 24 4 Ply Tire / 10 x 24 Wheel / Tubeless	
4DQ434GY-10W-TB	14.9 x 24	14.9 x 24 4 Ply Tire / 10 x 24 Wheel / Tube	
4DQ434GY-12W-2-TL	14.9 x 24	14.9 x 24 4 Ply Tire / 12 x 24 -2° OS Wheel / Tubeless	
4DQ434GY-12W-2-TB	14.9 x 24	14.9 x 24 4 Ply Tire / 12 X 24 -2° OS Wheel / Tube	
4DQ434GY-12W-0-TL	14.9 x 24	14.9 x 24 4 Ply Tire / 12 x 24 0° OS Wheel / Tubeless	
4DQ434GY-12W-0-TB	14.9 x 24	14.9 x 24 4 Ply Tire / 12 x 24 0° OS Wheel / Tube	
4DQ408GY-SP-TL	11.2 x 38	11.2 x 38 4 Ply Tire / 10 x 38 SP Wheel / Tubeless	
4DQ408GY-SP-TB	11.2 x 38	11.2 x 38 4 Ply Tire / 10 x 38 SP Wheel / Tube	
4DQ408GY-DP-TL	11.2 x 38	11.2 x 38 4 Ply Tire / 10 x 38 DP Wheel / Tubeless	
4DQ408GY-DP-TB	11.2 x 38	11.2 x 38 4 Ply Tire / 10 x 38 DP Wheel / Tube	
4DQ408GY-TL-TL	11.2 x 38	11.2 x 38 4 Ply Tire / 10 x 38 TL Wheel / Tubeless	
4DQ408GY-TL-TB	11.2 x 38	11.2 x 38 4 Ply Tire / 10 x 38 TL Wheel / Tube	



- 1. ELECTRICAL
- 2. PUMP Acc.
- 3. HOSE, PE PIPE & Acc.
- 4. IPS, PIP Pipe & Acc.
- 5. SURFACE
- 6. SPRINKLERS
- 7. TRAVELER & WHEEL MOVE
- 8. PIVOT
- 9. TIRE
- 10. LOW VOLUME
- 11. FILTERS
- 12. INJECTION
- 13. HARDWARE
- INDEX

IMPORT NEW TIRES, WHEELS AND ASSEMBLIES

IMPORT NEW TIRES

Part No.	Size	Description	Price
SW24112CTT-IR1	11.2 x 24	11.2 x 24 Import New Tire - 6 PLY Tube Type	
SW24149CTT-IR1	14.9 x 24	14.9 x 24 Import New Tire - 6 PLY Tube Type	
SW38112CTT-IR1	11.2 x 38	11.2 x 38 Import New Tire - 6 PLY Tube Type	



IMPORT WHEELS

Part No.	Size	Description	Price
W24088G	8 x 24	Galvanized Wheel for 11.2 x 24 -2° OS	
W240880G	8 x 24	Galvanized Wheel for 11.2 x 24 0° OS	
W24108G	10 x 24	Galvanized Wheel for 11.2 x 24 & 14.9 x 24 -2° OS	
W241083G	10 x 24	Galvanized Wheel for 11.2 x 24 & 14.9 x 24 VOS	
W24128G	12 x 24	Galvanized Wheel for 14.9 x 24 -2° OS	
W38108G-RI	10 x 38	Galvanized Wheel for 11.2 x 38 - Reinforced	



IMPORT TIRE & WHEEL ASSEMBLIES

Part No.	Size	Description	Price
SR12411206-T	11.2 x 24	11.2 x 24 6 Ply Tire / 8 x 24 Wheel / Tube	
SR12414906-T	14.9 x 24	14.9 x 24 6 Ply Tire / 10 x 24 -2° OS / Tube	
SR12414906-T-V	14.9 x 24	14.9 x 24 6 Ply Tire / 10 x 24 VOS / Tube	
SR13811206-T	11.2 x 38	11.2 x 38 6 Ply Tire / 10 x 38 Reinforced Wheel / Tube	

RECAPPED TIRES, GALVANIZED WHEELS, TUBES AND ASSEMBLIES

RECAPPED TIRES

Part No.	Size	Description	Price
9800M	10" x 20	10 x 20 Recap Tire	
9800	10 x 22	10 x 22 Recap Tire	
9800M	11 x 22.5	11 x 22.5 Recap Tire	
9800	11 x 24.5	11 x 24.5 Recap Tire	



TITAN® GALVANIZED WHEELS

Part No.	Size	Description	Price
051620400013	8.25 x 22.5	Galvanized Wheel for 11 x 22.5	
050777100013	8.25 x 24.5	Galvanized Wheel for 11 x 24.5	

TUBE FOR RECAPPED TIRES

Part No.	Size	Description	Price
3FM03	ALL	Tube for 11 x 22.5 & 11 x 24.5	



RECAPPED ASSEMBLIES

Part No.	Size	Description	Price
RT-11X225-GW	11 x 22.5	11 x 22.5 Recap Tire / 8.25 x 22.5 Wheel / Tube	
RT-11X245-GW	11 x 24.5	11 x 24.5 Recap Tire / 8.25 x 24.5 Wheel / Tube	

MACH II TIRES

MACH II - TIRES

Part No.	Description	Price
M-3010-A	11.2x24 Tire Only For 8" RIM - Old Style Plastic	
M-3010-AR	11.2x24 Tire with 8" Galvanized Rim - Old Style Plastic	
M-3010-R	8" Galvanized Rim	
M-3100-A	11.2x24 Tire Only For 8" Rim - New Style Plastic	
M-3100-AR	11.2x24 Tire with 8" Galvanized Rim - New Style Plastic	
M-3010-R	8" Galvanized Rim	
M-3090-A	11.2x24 Tire Only For 10" Rim - New Style Plastic	
M-3090-AR	11.2x24 Tire with 10" Galvanized Rim - New Style Plastic	
M-3020-R	10" Galvanized Rim	
M-3020-A	14.9x24 Tire Only For 10" RIM - Old Style Plastic	
M-3020-AR	14.9x24 Tire with 10" Galvanized Rim - Old Style Plastic	
M-3020-R	10" Galvanized Rim	
M-3120-A	14.9x24 Tire Only For 10" Rim - New Style Plastic	
M-3120-AR	14.9s24 Tire with 10" Galvanized Rim - New Style Plastic	
M-3020-R	10" Galvanized Rim	
M-3030-A	14.9x24 Tire Only For 8" RIM - Old Style Plastic	
M-3030-AR	14.9x24 Tire with 8" Galvanized Rim - Old Style Plastic	
M-3010-R	8" Galvanized RIM	
M-3130-A	14.9x24 Tire Only For 12" Rim - New Style	
M-3040-A	11.2x38 Tire Only For 10" Rim - Old Style	
M-3040-AR	11.2x38 Tire with 10" Galvanized Rim - Old Style	
M-3040-R	10" Galvanized Rim	
M-3080-A	11.2x38 Tire Only For 10" Rim (96 LBS) - New Style Plastic	
M-3080-AR	11.2x38 Tire with 10" Galvanized Rim - New Style Plastic	
M-3040-R	10" Galvanized Rim	
M-3140-A	13.6x38 Tire Only For 10" Rim - New Style	
M-3140-AR	13.6x38 Tire with 10" Galvanized Rim - New Style	
M-3040-R	10" Galvanized Rim	
M-3110-A	10.0x22 Tire Only	
M-3060-A	10x20 Tire Only	
M-3050-A	11.0x22.5R Tire Only	
M-3070-A	11.0x24.5 Tire Only	



This tire design can be used on any combination of towers or complete systems and is made to accommodate all center pivot irrigation systems.

- Made of a high grade polyethylene material containing a UV inhibitor.
- Can be purchased in two halves and bolted onto an existing rim.
- Easy and simple installation. (see Mounting Instructions)
- May also be purchased complete with a furnished steel rim.
- New design features greatly improved flotation and far less strain on drive line components.
- Tire design can be used on any combination of towers or complete systems.
- Made to accommodate all center pivot systems.
- Solves the problem of stuck center pivots and flat tires during irrigation season when down time of the sprinkler system can be crucial to crops.
- This tire keeps sprinkler moving with superior traction, excellent durability, increased longevity, and improved tire track.

MACH II - TRACTION PLATE

Part No.	Description	Price
4105001	Traction Plate	

GALVANIZED RIMS

Part No.	Description	Price
GB-W24088G	RIM, GALV. 24 x 8	
GB-W24108G	RIM, GALV. 24 x 10	
GB-W28108G-RI	RIM, GALV. 38 X 10 REINFORCED	

TIRES AND WHEEL ACCESSORIES

REINFORCING FLANGE

Part No.	Description	Price
WHLCNTR	Reinforcing Flange for Wheel Center	



NO SPIN LUGS

Reversible No Spin Lug

Tower Stuck? This product has over 15 years of successful testing and is field proven. Uniquely designed and manufactured of steel to meet the rigorous demands of heavy duty applications. Light weight from 14 to 19 lbs. depending upon size. Invented by a farmer, for the farmer, making it easy to transport into the field and install on either the leading or trailing tire in minutes. Best results occur when at least two lugs are installed per tower, one on each tire at 180 degree positioning to ensure one lug is engaged into the ground during movement allowing for increased traction. Generation III production features entire smooth metal contact with the tire to reduce tire wear and notched bar to promote stability and prohibit the lug from rolling sideways. The new "tractor tread" type paddle without gussets also promote self cleaning abilities. Patent Pending Stays clean even in clay soils. Little or no maintenance required.

REVERSIBLE NO SPIN LUG - GENERATION III

Part No.	Tire Size	Price
NSL11R	11.2	
NSL14R	14.9	
NSL16R	16.9	

- Taller Paddle Provides 18% more traction than the Generation II
- Curved "Tractor Tread" type paddle without gussets promotes self cleaning during rotation
- Smooth inside body contact to the tire to decrease tire wear
- Notch bar resists side to side movement

NO SPIN LUG PARTS

Part No.	Description	Price
NSL11.2-C	No Spin Lug Chain Assembly 11.2	
NSL14.9-C	No Spin Lug Chain Assembly 14.9	
NSL-LINK	No Spin Lug Link Only	
NSL-NB	No Spin Lug Notched Bar	



MACH II REVERSIBLE NO SPIN LUG

Part No.	Tire Size	Price
NSL-M2-38	No Spin Lug for 3040 & 3080	

Other sizes can be made upon request. Please call for availability.

No Spin Lugs has developed a lug for the Mach II wheel for sprinkler pivots. This lug has all the same dependable features of the conventional Generation III style No Spin Lug, but attaches to the sprinkler pivot wheel by clamping rather than compressing around the tire with a bolt and chain. The current field tested model will fit the 3080 and 3040 - 11.2 tires. Patent Pending



RAAFT TRACKS

Don't be afraid to water

- When water is applied RAAFT tracks will last longer.
- Water cools, cleans, and lubricates polyethylene and prevents mud from building up inside the track.
- When ridges and/or ruts are wet and softened, the track can better align itself with the pivot and tire, thus reducing the stresses from turning and side slipping.
- RAAFT Tracks create "little dams" that increase soil water absorption on hills and flat land, which greatly reduces pivot track wash-outs and erosion.

Features

- Quick & easy to install
- Helps keep center pivots from getting stuck
- Reduces or eliminates tracks and ruts
- Fits tire sizes: 11.2x24, 11x24.5, 11x22.5, 11.2x38, 14.9x24
- Can withstand bridges yet float with ease over acres of muddy terrain
- Environmentally friendly
- RAAFT Tracks are "The Smart Choice"



RAAFT TRACKS

Part Number	Description	Weight	Minimum Tower Units Per Order			Price
			1-9	10-19	20+	
PR-TW-525	Two Each - 5 Piece RAAFT TRACK Assemblies for tire size 11x22.5, 11x24.5 & 11.2x24.	344 Lbs/tower (2 bundles of 172 Lbs each)				
PR-TW-526	Two Each - 6 Piece RAAFT TRACK Assemblies for tire size 11x22.5, 11x24.5 & 11.2x24 including one conversion kit to modify two track assemblies to fit 11.2X38 tires.	412 Lbs/tower (2 bundles of 172 Lbs each and 1 bundle of 68 Lbs)				
PR-TW-700	Two Each - 5 Piece RAAFT TRACK Assemblies for tire size 14.9x24.	456 Lbs/tower (2 bundles of 228 Lbs each)				
2PWS84	Two Each - RAAFT 8 Bolt 4 inch wheel spacers. Note: Spacers needed for all short shaft applications and all 14.9x24 applications. Long shaft gear boxes with offset wheels may be an exception. 11" of clearance is needed from the center of the tire.	33 Lbs/tower (2 each spacers 16.5 lbs each)				

Tough, Rugged, & Built to Last

RAAFT Tracks are Manufactured from a Tough Polyethylene Carbon Composite Plastic that provides superior UV and chemical resistance; 100% recyclable and light weight with just 1/2 the weight of steel tracks.

RAAFT Tracks Feature Innovative Engineering & Design like the unique RAAFT joint that allows for multi-planar movement and the flexibility to traverse rutted and ridged ground. RAAFT Tracks are designed for circular paths, providing low side and turning resistance and maximum forward and reverse traction. The results of which are an increase in drive-train life due to the reduction of load-induced wheel spin.

RAAFT Tracks Provide High Flotation 5-8 times less ground pressure than high floatation tires and 1.5 times more than competitive tracks.

RAAFT Tracks Come Pre-Assembled at the factory. Final assembly in the field can be easily performed by one person and only requires 4 bolts (per tower) to complete.

RAAFT Tracks Resist the Elements. RAAFT Tracks are designed to operate in field conditions of minimum 40°F through a maximum of 105°F with water being applied to wet the track and they can be winter moved at temperatures down to -10°F.

Model	RAAFT 525	RAAFT 526	RAAFT 700	Steel Track	11.2 - 24"	11.2 - 38"	14.9-24"	16.9-24"	
Contact Area in ²	510	510	700	430	90	120	265	283	
Wt.# of 1 ea tire unit (Lbs)	172	204	228	360	85	96	99	144	
Maximum Allowable Ground Pressure PSI	PSI	Maximum Supported Tower Wt (Lbs)							
	6	6120	6120	8400	5160	1080	1440	3180	3396
	8	8160	8160	11200	6880	1440	1920	4240	4528
	10	10200	10200	14000	8600	1800	2400	5300	5660
	12	12240	12240	***	10320	2160	2880	6360	6792
	16	***	***	***	***	2880	3840	8480	9056
	20	***	***	***	***	3600	4800	10600	11320
	24	***	***	***	***	4320	5760	12720	***
28	***	***	***	***	5040	6720	***	***	
Fits Tire Size	11.2-24								
	11-22.5		11.2-38	14.9-24	11-22.5				
	11-24.5								
	10" max rim width	10" max rim width	13" max rim width	Recaps Only					

SECTION 9

Turf Irrigation

CONTENTS

9:3	TURF IRRIGATION NOTES
9:4-8	SPRAY HEADS
9:4	RAIN BIRD® SPRAY HEADS
9:5	RAIN BIRD® 1800 SERIES POP-UP SPRAY HEADS
9:5	RAIN BIRD® UNI-SPRAY™ SERIES POP-UP SPRAY HEADS
9:6	HUNTER® SPRAY HEADS
9:7	HUNTER® POP-UP SPRAY HEADS
9:8	TORO® 570Z SERIES POP-UP SPRAY HEADS
9:9-14	NOZZLES
9:9	RAIN BIRD® MPR NOZZLES
9:9	RAIN BIRD® SPECIALTY NOZZLES
9:10	RAIN BIRD® VARIABLE ARC NOZZLES
9:10	RAIN BIRD® U-SERIES NOZZLES
9:11	TORO® PRECISION™ SERIES NOZZLES
9:12	HUNTER® ADJUSTABLE NOZZLES
9:12	RAIN BIRD® SHRUB ADAPTER
9:12	TORO® PRECISION™ ROTATING NOZZLES
9:12	RAIN BIRD® ROTARY NOZZLES
9:13	HUNTER® MP ROTATOR® ROTARY NOZZLES
9:14	HUNTER® MP ROTATOR® ACCESSORIES
9:14	HUNTER® SPRINKLER COMPANY MP ROTATOR® ACCESSORIES
9:15	BUBBLERS
9:16-21	GEAR DRIVEN ROTORS
9:16	RAIN BIRD® ROTORS
9:17	RAIN BIRD® ROTORS
9:18	RAIN BIRD® ROTORS
9:18	RAIN BIRD® IMPACT ROTORS
9:19	HUNTER® ROTORS
9:20	HUNTER® ROTORS
9:21	HUNTER® ROTORS
9:22-23	GOLF ROTORS
9:24-26	IMPACT SPRINKLERS & NOZZLES
9:24	RAIN BIRD® BRASS IMPACT SPRINKLERS & NOZZLES
9:25	NELSON BRASS IMPACT SPRINKLERS & NOZZLES
9:25	WEATHER-TEC BRASS IMPACT SPRINKLERS
9:26	XCAD BRASS AND MULTI-COMPOSITE™ IMPACT SPRINKLERS & NOZZLES
9:27	QUICK COUPLING VALVES & KEYS
9:28	SWING JOINTS
9:29	NIPPLES, CUT-OFF NIPPLES & RISERS
9:30	SWING PIPE, PVC IPS HOSE & BARBED FITTINGS
9:31-38	CONTROL VALVES
9:31	RAIN BIRD® CONTROL VALVES
9:32	RAIN BIRD® CONTROL VALVES
9:33	HUNTER® CONTROL VALVES
9:34	HUNTER® CONTROL VALVES
9:35	IRRITROL® CONTROL VALVES
9:36	IRRITROL® CONTROL VALVES
9:36	JOHN DEERE™ QUANTUM VALVES
9:36	CHAMPION® CONTROL VALVES
9:37	TORO® VALVES
9:38	TORO® VALVES



RAIN BIRD® SPRAY HEADS



RAIN BIRD® SPRAY HEAD APPLICATIONS AND FEATURES

Primary Applications	1800 Series	1800 PRS	1800 SAM	1800 SAM-PRS	UNI Spray Series
Turfgrass	•	•	•	•	•
Residential / Commercial	•	•	•	•	•
Slopes			•	•	
Ground Cover / Shrubs	•	•	•	•	•
Low Pressure Systems	•				•
Optional SAM™ *			•	•	•
Optional PRS **		•		•	
Optional Non-Potable Water Cover	•	•	•	•	•
Optional Vandal Proof Cap	•	•	•	•	
Pop-Up Heights Available	2", 4", 6", 12"	4", 6", 12"	4", 6", 12"	4", 6", 12"	2", 4", 6"
Spacing Range ***	3' - 24'	3' - 24'	3' - 24'	3' - 24'	8' - 18'
Adjustable Arc Range					0 - 360°
Operating Pressure Range (PSI) ****	15 - 70	15 - 70	25 - 70	25 - 70	15 - 70
Flow Range (GPM)	.07 - 5.32	.07 - 5.32	.07 - 5.32	.07 - 5.32	.07 - 5.32
Inlet Thread (FIPT)	1/2"	1/2"	1/2"	1/2"	1/2"

* Optional Seal-O-Matic (SAM™) check valve holds up to 14 feet (8 feet in the US Series) of elevation change, to prevent puddling and erosion caused by low head drainage. The SAM™ check valve is factory installed in the 1800 series and field installed in the UNI Spray series.

** Optional PRS (Pressure Regulating Stem) reduces operating pressure to an average of 30 PSI; allows for optimal nozzle performance, saves water, and ends misting and fogging caused by high pressure.

*** 3 to 18 feet with standard Rain Bird® Spray Head Nozzles (MPR, VAN, U-Series), 13-24 feet with Rain Bird® Rotary Nozzles.

**** MPR, VAN and U series nozzles recommended at 15 - 30 PSI. Rotary nozzles recommended at 20 -55 PSI.

RAIN BIRD® 1800 SERIES POP-UP SPRAY HEADS

1800® SERIES

Part No.	Pop-Up Size	Description	Price
1802	2"	1800 Spray Head Body Only	
1804	4"	1800 Spray Head Body Only	
1806	6"	1800 Spray Head Body Only	
1812	12"	1800 Spray Head Body Only	

Less Nozzle - 1/2" FIPT Inlet

1800®-SAM SERIES

Part No.	Pop-Up Size	Description	Price
1804SAM	4"	1800 Spray Head Body Only w/SAM	
1806SAM	6"	1800 Spray Head Body Only w/SAM	
1812SAM	12"	1800 Spray Head Body Only w/SAM	

Less Nozzle - 1/2" FIPT Inlet

1800®-PRS SERIES

Part No.	Pop-Up Size	Description	Price
1804PRS	4"	1800 Spray Head Body Only w/PRS	
1806PRS	6"	1800 Spray Head Body Only w/PRS	
1812PRS	12"	1800 Spray Head Body Only w/PRS	

Less Nozzle - 1/2" FIPT Inlet

1800®-SAM-PRS SERIES

Part No.	Pop-Up Size	Description	Price
1804SAM-PRS	4"	1800 Spray Head Body Only w/SAM & PRS	
1806SAM-PRS	6"	1800 Spray Head Body Only w/SAM & PRS	
1812SAM-PRS	12"	1800 Spray Head Body Only w/SAM & PRS	

Less Nozzle - 1/2" FIPT Inlet



RAIN BIRD® UNI-SPRAY™ SERIES POP-UP SPRAY HEADS

UNI-SPRAY™ SERIES

Part No.	Pop-Up Size	Description	Price
US-400	4"	UNI-Spray Spray Head Body Only	
US-600	6"	UNI-Spray Spray Head Body Only	

Less Nozzle - 1/2" FIPT Inlet

UNI-SPRAY™ SERIES WITH VAN NOZZLE

Part No.	Pop-Up Size	Description	Price
US-410	4"	UNI-Spray Spray Head Body Only w/10VAN	
US-412	4"	UNI-Spray Spray Head Body Only w/12VAN	
US-415	4"	UNI-Spray Spray Head Body Only w/15VAN	
US-418	4"	UNI-Spray Spray Head Body Only w/18VAN	

1/2" FIPT Inlet



INTRO
1. ELECTRICAL
2. PUMP, ACC.
3. HOSE, PE PIPE & ACC.
4. IPS, PIP PIPE & ACC.
5. SURFACE
6. SPRINKLERS
7. TRAVELER & WHEEL MOVE
8. PIVOT
9. TURF
10. LOW VOLUME
11. FILTERS
12. INJECTION
13. HARDWARE
INDEX

HUNTER® SPRAY HEADS



HUNTER® SPRAY HEAD APPLICATIONS AND FEATURES

Primary Applications	PS Ultra	PRO Spray®
Turfgrass	•	•
Ground Cover		•
Shrubs	•	•
Residential	•	•
Commercial		•
Adjustable Arc Nozzle Tree Included	•	
Optional Drain Check Valve*	•	•
Optional Non-Potable Water Cover	•	•
Optional Black Rubber Cover		•
Optional Vandal Proof Cap		•
Pop-Up Heights Available	Shrub, 2", 4"	Shrub, 2", 3", 4", 6", 12"
Radius Throw	10' - 19'	4' - 19'
Recommended Pressure Range (PSI)	20 - 40	15 - 70
Flow (GPM)	.2 - 5.3	.09 - 5.62
Precipitation Rate (In./Hr.)	1.4 - 1.7	1.21 - 2.94
Inlet Thread (FIPT)	1/2"	1/2"

* Drain check valves are field installed in the PS and SRS series heads. In the Pro-Spray and Institutional Spray, drain check valves are available for either field or factory installation. The PS and SRS series check valves protect against up to 7 feet of elevation change, the Pro-Spray series against up to 10 feet and the Institutional Spray is protected against up to 14 feet of elevation change.

HUNTER® POP-UP SPRAY HEADS

PS ULTRA 2" POP-UP SPRINKLER WITH NOZZLE

Part No.	Pop-Up Size	Description	Price
PSU-02-10A	2"	10' Radius, Adjustable Arc (1-360°)	
PSU-02-12A	2"	12' Radius, Adjustable Arc (1-360°)	
PSU-02-15A	2"	15' Radius, Adjustable Arc (1-360°)	
PSU-02-17A	2"	17' Radius, Adjustable Arc (1-360°)	
PSU-02-5SS	2"	5' x 30' Side Strip	

With Integral nozzle and 1/2" FIPT Inlet

PS ULTRA 4" POP-UP SPRINKLER WITH NOZZLE

Part No.	Pop-Up Size	Description	Price
PSU-04-10A	4"	10' Radius, Adjustable Arc (1-360°)	
PSU-04-12A	4"	12' Radius, Adjustable Arc (1-360°)	
PSU-04-15A	4"	15' Radius, Adjustable Arc (1-360°)	
PSU-04-17A	4"	17' Radius, Adjustable Arc (1-360°)	
PSU-04-5SS	4"	5' x 30' Side Strip	

With Integral nozzle and 1/2" FIPT Inlet

PRO-SPRAY® SPRINKLER BODIES

Part No.	Pop-Up Size	Description	Price
PROS-04	4"	4" Pop-Up Spray Body, Accepts Female Thread Nozzles	
458520		Reclaimed Water Thread-on Body Cap, Pro-Spray	

Less Nozzle - 1/2" FIPT Inlet



The MP Rotator® has proven to be the most effective and innovative sprinkler on the market today. To make it even easier to use, Hunter is now offering the MPR40 sprinkler body. Based on well known pop-up body technology, the MPR40 body provides 40 psi pressure regulation and a check valve. This delivers the water saving function of a drain check valve at a pressure that will give full range performance from the MP Rotator. The MPR40 body and the non-regulated or checked MPR body are high quality sprinkler bodies made specifically to compliment the MP Rotator.

MPR40 & MPR

Part No.	Model No.	Description	Price
11160-001	MPR40-04CV	4" Pop-Up Body with 40 PSI Regulator & Check Valve	
11160-002	MPR40-06CV	6" Pop-Up Body with 40 PSI Regulator & Check Valve	
11160-003	MPR40-12CV	12" Pop-Up Body with 40 PSI Regulator & Check Valve	
11160-004	MPR40-00	Shrub Adapter Body with 40 PSI Regulator without Check Valve	
11160-005	MPR04	4" Pop-Up Body without Regulator or Check Valve	
11160-006	MPR06	6" Pop-Up Body without Regulator or Check Valve	
11160-007	MPR12	12" Pop-Up Body without Regulator or Check Valve	



MPR40 & MPR PERFORMANCE CHART

Information	MPR	MPR40
Factory Installed Check Valve*	•	
Pressure Regulating	•	
Optional Black Rubber Cover	•	•
Optional Non-Potable Water Cover	•	•
Optional Vandal Proof Cap	•	•
Pop-Up Heights Available	4", 6", 12"	4", 6", 12"
Operating Pressure (PSI)	15 - 100	45 - 100
Radius	8' - 30'	8' - 30'
Inlet Thread (FIPT)	1/2"	1/2"
Flow Rate (GPM)	.14 - 4.27	.14 - 4.27
Precipitation Rate (IN/HR)	.35 - .52	.35 - .52
Arc Adjustment	0 - 360°	0 - 360°

* Protects against low head drainage of up to 14 feet

ACCESSORIES

Part No.	Model No.	Description	Price
11160-009	RC	Field Installed, Snap-On Black Rubber Cover	
11160-010	RWC	Field Installed, Snap-On Purple Reclaimed Water ID Cap	

INTRO
 1. ELECTRICAL
 2. PUMP, ACC.
 3. HOSE, PE PIPE & ACC.
 4. IPS, PIP PIPE & ACC.
 5. SURFACE
 6. SPRINKLERS
 7. TRAVELER & WHEEL MOVE
 8. PIVOT
 9. TURF
 10. LOW VOLUME
 11. FILTERS
 12. INJECTION
 13. HARDWARE
 INDEX

TORO® 570Z SERIES POP-UP SPRAY HEADS

TORO® POP-UP SPRAY HEAD APPLICATIONS AND FEATURES

Primary Applications	570Z	570ZPR
Radius	2' - 18'	2' - 18'
Flow Range	0.05 - 4.50 GPM	0.05 - 3.45 GPM
Recommended Operating Pressure	20 - 50 PSI	30 - 70 PSI
Turf	•	•
Shrubs / Ground Cover	•	•
Slopes	•	•
High Pressure Systems		•
Low Pressure Systems	•	•
Medians		•
High Traffic Areas		•
High Wind		•
Pop-Up Heights Available	2", 3", 4", 6", 12"	4", 6", 12"
Side Inlet Option	6", 12"	6", 12"
Check Valve Option	•	•
Effluent Water Option	•	•
Shrub Model	•	•
Zero Flush	•	•
Built-In Pressure Regulator		•
Serviceable Seal	•	•
Warranty	2 Year	5 Year

The 570Z is ideal for small to medium size landscape areas and intricate designs. The PR model is ideal for applications with high or varying operating pressure, including long lines and slopes.

Additional Features

- Stainless steel retraction spring
- All bodies shipped with flush plug in place

570Z SERIES

Part No.	Pop-Up Size	Description	Price
570Z-2P	2"	Sprinkler	
570Z-3P	3"	Sprinkler	
570Z-4P	4"	Sprinkler	
570Z-4PCOM	4"	Sprinkler, with Check Valve	
570Z-6P	6"	Sprinkler	
570Z-6PSI	6"	Sprinkler, Side-inlet Body	
570Z-6PCOM	6"	Sprinkler, with Check Valve	
570Z-12P	12"	Sprinkler	
570Z-12PSI	12"	Sprinkler, Side-inlet Body	
570Z-12PCOM	12"	Sprinkler, with Check Valve	
570S		Shrub Adapter	

Less Nozzle - 1/2" FIPT Inlet



570ZPR SERIES

Part No.	Pop-Up Size	Description	Price
570Z-4P PR	4"	Sprinkler, with Pressure Regulation	
570Z-4P PR COM	4"	Sprinkler, with Check Valve & Pressure Regulation	
570Z-6P PR	6"	Sprinkler, with Pressure Regulation	
570Z-6P PR COM	6"	Sprinkler, with Check Valve & Pressure Regulation	
570Z-12P PR	12"	Sprinkler, with Pressure Regulation	
570Z-12P PR COM	12"	Sprinkler, with Check Valve & Pressure Regulation	
570S-PR		Shrub, with Pressure Regulation	

Less Nozzle - 1/2" FIPT Inlet



RAIN BIRD® MPR NOZZLES

PLASTIC 5 SERIES WITH SCREEN

Part No.	PSI	Trajectory Ft.	Radius Pattern	Price
5F	15 - 30	3 - 5	Full Circle	
5H	15 - 30	3 - 5	Half Circle	
5Q	15 - 30	3 - 5	Quarter Circle	

PLASTIC 8 SERIES WITH SCREEN

Part No.	PSI	Trajectory Ft.	Radius Pattern	Price
8F	15 - 30	5 - 8	Full Circle	
8H	15 - 30	5 - 8	Half Circle	
8Q	15 - 30	5 - 8	Quarter Circle	

PLASTIC 10 SERIES WITH SCREEN

Part No.	PSI	Trajectory Ft.	Radius Pattern	Price
10F	15 - 30	7 - 10	Full Circle	
10H	15 - 30	7 - 10	Half Circle	
10Q	15 - 30	7 - 10	Quarter Circle	

PLASTIC 12 SERIES WITH SCREEN

Part No.	PSI	Trajectory Ft.	Radius Pattern	Price
12F	15 - 30	9 - 12	Full Circle	
12H	15 - 30	9 - 12	Half Circle	
12Q	15 - 30	9 - 12	Quarter Circle	

PLASTIC 15 SERIES WITH SCREEN

Part No.	PSI	Trajectory Ft.	Radius Pattern	Price
15F	15 - 30	11 - 15	Full Circle	
15H	15 - 30	11 - 15	Half Circle	
15EST	15 - 30	4 x 13 - 15	End Strip	
15CST	15 - 30	4 x 26 - 30	Center Strip	
15SST	15 - 30	4 x 26 - 30	Side Strip	
15LCS	15 - 30	3 x 11 - 15	Left Corner Strip	
15RCS	15 - 30	3 x 11 - 15	Right Corner Strip	
9SST	15 - 30	9 x 15 - 18	Side Strip 9' x 8'	

RAIN BIRD® SPECIALTY NOZZLES

8 SERIES PLASTIC FLAT ANGLE MPR NOZZLE W/ SCREEN

Part No.	PSI	Trajectory Ft.	Radius Pattern	Price
8HFLT	15 - 30	6 - 8	Half Circle	
8QFLT	15 - 30	6 - 8	Quarter Circle	



INTRO | 1. ELECTRICAL | 2. PUMP, ACC. | 3. HOSE, PE PIPE & ACC. | 4. IPS, PIP PIPE & ACC. | 5. SURFACE | 6. SPRINKLERS | 7. TRAVELER & WHEEL MOVE | 8. PIVOT | 9. TURF | 10. LOW VOLUME | 11. FILTERS | 12. INJECTION | 13. HARDWARE | INDEX

RAIN BIRD® VARIABLE ARC NOZZLES

VAN NOZZLE WITH SCREEN

Part No.	PSI	Trajectory Ft.	Radius Pattern	Price
4VAN	15 - 30	3 - 4	0° - 330°	
6VAN	15 - 30	4 - 6	0° - 330°	
8VAN	15 - 30	6 - 8	0° - 330°	
10VAN	15 - 30	8 - 10	0° - 360°	
12VAN	15 - 30	10 - 12	0° - 360°	
15VAN	15 - 30	12 - 15	0° - 360°	
18VAN	15 - 30	14 - 18	0° - 360°	



HIGH EFFICIENCY VAN NOZZLE

Part No.	PSI	Trajectory Ft.	Radius Pattern	Price
HE-VAN-8	15 - 30	6 - 8	90° - 360°	
HE-VAN-10	15 - 30	8 - 10	90° - 360°	
HE-VAN-12	15 - 30	10 - 12	90° - 360°	
HE-VAN-15	15 - 30	12 - 15	90° - 360°	



Efficiency Ratings

Rain Bird HE-VAN Nozzles deliver an average DULQ of 70%, more than a 40% improvement over typical variable arc spray nozzles.

Rain Bird HE-VAN Nozzles deliver an SC less than or equal to 1.6, which is 35% lower than the typical variable arc spray nozzle.

RAIN BIRD® U-SERIES NOZZLES

PLASTIC U-8 SERIES MPR NOZZLE WITH SCREEN

Part No.	PSI	Trajectory Ft.	Radius Pattern	Price
U8F	15 - 30	5 - 8	Full Circle	
U8H	15 - 30	5 - 8	Half Circle	
U8T	15 - 30	5 - 8	Third Circle	
U8Q	15 - 30	5 - 8	Quarter Circle	



PLASTIC U-10 SERIES MPR NOZZLE WITH SCREEN

Part No.	PSI	Trajectory Ft.	Radius Pattern	Price
U10F	15 - 30	7 - 10	Full Circle	
U10H	15 - 30	7 - 10	Half Circle	
U10T	15 - 30	7 - 10	Third Circle	
U10Q	15 - 30	7 - 10	Quarter Circle	



PLASTIC U-12 SERIES MPR NOZZLE WITH SCREEN

Part No.	PSI	Trajectory Ft.	Radius Pattern	Price
U12F	15 - 30	9 - 12	Full Circle	
U12TQ	15 - 30	9 - 12	Three Quarter	
U12TT	15 - 30	9 - 12	Two Thirds	
U12H	15 - 30	9 - 12	Half Circle	
U12T	15 - 30	9 - 12	Third Circle	
U12Q	15 - 30	9 - 12	Quarter Circle	

PLASTIC U-15 SERIES MPR NOZZLE WITH SCREEN

Part No.	PSI	Trajectory Ft.	Radius Pattern	Price
U15F	15 - 30	11 - 15	Full Circle	
U15TQ	15 - 30	11 - 15	Three Quarter	
U15TT	15 - 30	11 - 15	Two Thirds	
U15H	15 - 30	11 - 15	Half Circle	
U15T	15 - 30	11 - 15	Third Circle	
U15Q	15 - 30	11 - 15	Quarter Circle	

TORO® PRECISION™ SERIES NOZZLES

	5' "O" Nozzles		8' "O" Nozzles		10' "O" Nozzles		
Pattern	Male	Female	Male	Female	Male	Female	Price
60°	O-T-5-60	O-5-60	O-T-8-60	O-8-60	O-T-10-60	O-10-60	
90°	O-T-5-Q	O-5-Q	O-T-8-Q	O-8-Q	O-T-10-Q	O-10-Q	
120°	O-T-5-T	O-5-T	O-T-8-T	O-8-T	O-T-10-T	O-10-T	
150°	O-T-5-150	O-5-1501	O-T-8-150	O-8-150	O-T-10-150	O-10-150	
180°	O-T-5-H	O-5-H	O-T-8-H	O-8-H	O-T-10-H	O-10-H	
210°	O-T-5-210	O-5-210	O-T-8-210	O-8-210	O-T-10-210	O-10-210	
240°	O-T-5-TT	O-5-TT	O-T-8-TT	O-8-TT	O-T-10-TT	O-10-TT	
270°	O-T-5-TQ	O-5-TQ	O-T-8-TQ	O-8-TQ	O-T-10-TQ	O-10-TQ	
360°	O-T-5-F	O-5-F	O-T-8-F	O-8-F	O-T-10-F	O-10-F	



	12' "O" Nozzles		15' "O" Nozzles		
Pattern	Male	Female	Male	Female	Price
60°	O-T-12-60	O-12-60	O-T-15-60	O-15-60	
90°	O-T-12-Q	O-12-Q	O-T-15-Q	O-15-Q	
120°	O-T-12-T	O-12-T	O-T-15-T	O-15-T	
150°	O-T-12-150	O-12-150	O-T-15-150	O-15-150	
180°	O-T-12-H	O-12-H	O-T-15-H	O-15-H	
210°	O-T-12-210	O-12-210	O-T-15-210	O-15-210	
240°	O-T-12-TT	O-12-TT	O-T-15-TT	O-15-TT	
270°	O-T-12-TQ	O-12-TQ	O-T-15-TQ	O-15-TQ	
360°	O-T-12-F	O-12-F	O-T-15-F	O-15-F	

	Specialty "O" Nozzles			
Pattern	Male	Female	Price	
Right Corner	O-T-4X9-RCS	O-4X9-RCS		
Left Corner	O-T-4X9-LCS	O-4X9-LCS		
Side Strip	O-T-4X18-SST	O-4X18-SST		
Left Corner	O-T-4X15-RCS	O-4X15-RCS		
Right Corner	O-T-4X15-LCS	O-4X15-LCS		
Side Strip	O-T-4X30-SST	O-4X30-SST		

MPR PLUS SPRAY NOZZLES

Pattern	PSI	5'	8'	10'	12'	15'	Price
90°	20 - 70	5-Q	8-Q	10-Q	12-Q	15-Q	
120°	20 - 70	5-T	8-T	10-T	12-T	15-T	
180°	20 - 70	5-H	8-H	10-H	12-H	15-H	
240°	20 - 70	5-TT	8-TT	10-TT	12-TT	15-TT	
270°	20 - 70	5-TQ	8-TQ	10-TQ	12-TQ	15-TQ	
360°	20 - 70	5-F	8-F	10-F	12-F	15-F	



Pattern	Specialty "O" Nozzles	Price
Side Strip	4SST	4' x 30'
End Strip	4EST	4' x 15'
Center Strip	4CST	4' x 30'
Side Strip	9SST	9' x 18'
Side Strip	4SSST	4' x 18'
Side Strip	2SST	2' x 6'

VARIABLE ARC NOZZLES (TVAN)

Part No.	PSI	Trajectory Ft.	Radius Pattern	Price
TVAN8	20 - 50	8'	0° - 360°	
TVAN10	20 - 50	10'	0° - 360°	
TVAN12	20 - 50	12'	0° - 360°	
TVAN15	20 - 50	15'	0° - 360°	
TVAN17	20 - 50	17'	0° - 360°	



INTRO
 1. ELECTRICAL
 2. PUMP Acc.
 3. HOSE, PE PIPE & Acc.
 4. IPS, PIP Pipe & Acc.
 5. SURFACE
 6. SPRINKLERS
 7. TRAVELER & WHEEL MOVE
 8. PIVOT
 9. TURF
 10. LOW VOLUME
 11. FILTERS
 12. INJECTION
 13. HARDWARE
 INDEX

HUNTER® ADJUSTABLE NOZZLES

ADJUSTABLE ARC NOZZLE

Part No.	PSI	Trajectory Ft.	Radius Pattern	Price
4-A	20 - 40	4	0° - 360°	
6-A	20 - 40	6	0° - 360°	
8-A	20 - 40	8	0° - 360°	
10-A	20 - 40	10	0° - 360°	
12-A	20 - 40	12	0° - 360°	
15-A	20 - 40	15	0° - 360°	
17-A	20 - 40	17	0° - 360°	



Female thread, compatible with all major brands

RAIN BIRD® SHRUB ADAPTER

PLASTIC SHRUB ADAPTER

Part No.	Description	Price
PA8S	Plastic Shrub Adapter Female 1/2" NPT x Nozzle Thread	
PA8SNP	Non-Potable Plastic Shrub Adapter Female 1/2" NPT x Nozzle Thread	



TORO® PRECISION™ ROTATING NOZZLES

PRECISION™ SERIES ROTATING NOZZLE

Part No.	Thread	PSI	Trajectory Ft.	Radius Pattern	Price
PRN-TA	Male	20-55	14' - 26'	45° - 270°	
PRN-TF	Male	20-55	14' - 26'	Full Circle	
PRN-A	Female	20-55	14' - 26'	45° - 270°	
PRN-F	Female	20-55	14' - 26'	Full Circle	



EZ ARC™ VISUAL ARC ADJUSTMENT

Part No.	Description	Price
EZ ARC	Visual indicators allow the user to quickly adjust the arc pattern to the desired arc from 45-270°.	



RAIN BIRD® ROTARY NOZZLES

ROTARY NOZZLE

Part No.	PSI	Trajectory Ft.	Radius Pattern	Price
R1318Q	20 - 55	13 - 18	Quarter Circle	
R1724Q	20 - 55	17 - 24	Quarter Circle	
R1318H	20 - 55	13 - 18	Half Circle	
R1724H	20 - 55	17 - 24	Half Circle	
R1318F	20 - 55	13 - 18	Full Circle	
R1724F	20 - 55	17 - 24	Full Circle	
R1318VAN	20 - 55	13 - 18	45° - 270°	
R1724VAN	20 - 55	17 - 24	45° - 270°	



HUNTER® MP ROTATOR® ROTARY NOZZLES

The revolutionary MP Rotator features a unique, multi-trajectory rotating stream delivery system that achieves water conserving results. Rather than simply “spray” water onto landscapes, MP Rotators deliver multiple streams of water at a steady rate. This slower application rate allows water to gently soak into the soil and achieves an even distribution throughout the area being irrigated. This increased efficiency results in 30% less water use when compared to traditional sprays and significantly reduces wasteful runoff. The MP Rotator can be installed onto any conventional spray head body or shrub adapter, transforming them into high uniformity, low precipitation rate sprinklers with matched precipitation at any arc and any radius.

The MP Rotators are a great choice for new systems, as they provide immense range flexibility (from 5' strip to 35' radius), decrease material costs, and provide better system efficiency. MPs are also perfect for revitalizing older systems. A retrofit can solve both low pressure and poor coverage problems.

MP ROTATOR®

Maintains Matched Precipitation - Any Arc, Any Radius

Part No.	Adjustable Arc	Stem Color	PSI	Radius Feet	GPM	Price
MP1000 (FEMALE THREAD)						
10759-1210	90° - 210°	Maroon	30 - 55	12 - 15	0.16 - 0.50	
10759-1270	210° - 270°	Light Blue	30 - 55	12 - 15	0.37 - 0.66	
10759-1360	360°	Olive	30 - 55	12 - 15	0.65 - 0.87	
MP1000T (MALE THREAD)						
10760-1210	90° - 210°	Maroon	30 - 55	12 - 15	0.16 - 0.50	
10760-1270	210° - 270°	Light Blue	30 - 55	12 - 15	0.37 - 0.66	
10760-1360	360°	Olive	30 - 55	12 - 15	0.65 - 0.87	
MP2000 (FEMALE THREAD)						
10489-1210	90° - 210°	Black	25 - 55	17 - 21	0.31 - 1.01	
10489-1270	210° - 270°	Green	25 - 55	16 - 21	0.68 - 1.30	
10489-1360	360°	Red	25 - 55	16 - 21	1.16 - 1.70	
MP2000T (MALE THREAD)						
10563-1210	90° - 210°	Black	25 - 55	17 - 21	0.31 - 1.01	
10563-1270	210° - 270°	Green	25 - 55	16 - 21	0.68 - 1.30	
10563-1360	360°	Red	25 - 55	16 - 21	1.16 - 1.70	
MP3000 (FEMALE THREAD)						
10661-1210	90° - 210°	Blue	25 - 55	25 - 30	0.69 - 2.49	
10661-1270	210° - 270°	Yellow	25 - 55	25 - 30	1.68 - 3.22	
10661-1360	360°	Gray	25 - 55	25 - 30	2.88 - 4.27	
MP3000T (MALE THREAD)						
10662-1210	90° - 210°	Blue	25 - 55	25 - 30	0.69 - 2.49	
10662-1270	210° - 270°	Yellow	25 - 55	25 - 30	1.68 - 3.22	
10662-1360	360°	Gray	25 - 55	25 - 30	2.88 - 4.27	
MP CORNER (SPECIFY FEMALE OR MALE THREAD)						
10962-1105F	45° - 105°	Turquoise	25 - 55	10.5 - 15	0.17 - 0.53	
10979-1105M	45° - 105°	Turquoise	25 - 55	10.5 - 15	0.17 - 0.53	
MP STRIPS (FEMALE THREAD)						
11009-001	MP Side Strip	Brown	30 - 50	4 x 24 - 6 x 34	0.27 - 0.51	
11009-002	MP Left Strip	Ivory	30 - 50	4 x 12 - 6 x 17	0.14 - 0.26	
11009-003	MP Right Strip	Copper	30 - 50	4 x 12 - 6 x 17	0.14 - 0.26	
MP STRIPS (MALE THREAD)						
11010-001	MP Side Strip T	Brown	30 - 50	4 x 24 - 6 x 34	0.27 - 0.51	
11010-002	MP Left Strip T	Ivory	30 - 50	4 x 12 - 6 x 17	0.14 - 0.26	
11010-003	MP Right Strip T	Copper	30 - 50	4 x 12 - 6 x 17	0.14 - 0.26	



1. ELECTRICAL
2. PUMP, ACC.
3. HOSE, PE PIPE & ACC.
4. IPS, PIP PIPE & ACC.
5. SURFACE
6. SPRINKLERS
7. TRAVELER & WHEEL MOVE
8. PIVOT
9. TURF
10. LOW VOLUME
11. FILTERS
12. INJECTION
13. HARDWARE
INDEX

HUNTER® MP ROTATOR® ACCESSORIES

MP ROTATOR® REPLACEMENT SCREENS

Part No.	Description	Price
10515-001	MP1000/2000/Corner/Strips - Fine (White)	
10580-001	MP1000T/2000T/CornerT/StripsT - Fine (Light Blue)	
10655	MP3000 - Coarse (Light Green)	
10580-002	MP3000T - Coarse (Tan)	



MP ROTATOR® ADJUSTMENT TOOLS

Part No.	Description	Price
10562	Arc/Radius Adjustment Tool	
11081	MP Matchstick Tool Kit (1 yellow, 1 orange tool/bag) - fit 1" PVC Pipe	
3038	MP Matchstick Decal	
10600	Pressure Gauge Adapter	



HUNTER® SPRINKLER COMPANY MP ROTATOR® ACCESSORIES

MP RISER, COMPONENTS AND ACCESSORIES

Part No.	Description	Price
10959	Complete MP Riser (36") - Packaged 10/Box	
10594	Components: MP Rotator Acme Adapter	
9677	Components: Stake Adapter, Acme Threaded	
9099-002	Components: 10mm Flexible Tubing, 100' Coil	
9774	Components: Lateral Take-Off (LTO), 10mm Compression x Barb	
10970	Components: Fiberglass Stake, .3125" (7.9mm) x 36"	
10623	Accessories: 1/2" Compression Adapter	
10615	Accessories: Acme Shut-Off Cap	
9813	Accessories: Coupler, 10mm	
9810	Accessories: Punch Tool, Blue	
10288	Accessories: Stake Installation Tool - 5/16" (8mm)	



RAIN BIRD® BUBBLERS

1300AF ADJUSTABLE BUBBLER WITH SCREEN

Part No.	PSI	GPM	Radius Pattern	Price
1300AF	10 - 60	1.0 - 2.30	Full Circle	

1/2" FIPT Inlet

1400 PRESSURE COMPENSATING BUBBLER W/ SCREEN

Part No.	PSI	GPM	Radius Pattern	Price
1401	20 - 90	0.25	Full, Trickle	
1402	20 - 90	0.50	Full, Trickle	
1404	20 - 90	1.00	Full, Umbrella	
1408	20 - 90	2.00	Full, Umbrella	

1/2" FIPT Inlet



HUNTER® BUBBLERS

AFB - ADJUSTABLE FLOOD BUBBLER

Part No.	GPM	Description	Price
AFB	2.0	1/2" FIPT "Flood Pattern"	
AFB-50	.50	1/2" FIPT "Flood Pattern"	

PCB - PRESSURE COMPENSATING BUBBLER

Part No.	GPM	Description	Price
PCB-25	.25	1/2" FIPT "Flood Pattern"	
PCB-50	.50	1/2" FIPT "Flood Pattern"	
PCB-10	1.0	1/2" FIPT "Flood Pattern"	
PCB-20	2.0	1/2" FIPT "Flood Pattern"	

PCN BUBBLER NOZZLE

Part No.	GPM	Description	Price
PCN-25	.25	Nozzle Thread - Trickle	
PCN-50	.50	Nozzle Thread - Trickle	
PCN-10	1.0	Nozzle Thread - Umbrella	
PCN-20	2.0	Nozzle Thread - Umbrella	



CHAMPION® BUBBLER

BUBBLER NOZZLE

Part No.	GPM	Description	Price
BPU	6	Full Adjustable Plastic Umbrella Bubbler w/UPC Label	



IRRITROL® BUBBLER

ADJUSTABLE FLOOD BUBBLER

Part No.	PSI	GPM	Radius Pattern	Price
533	20 - 40	1.36 - 5.9	Full Circle	

1/2" FIPT Inlet



INTRO
1. ELECTRICAL
2. PUMP Acc.
3. HOSE, PE PIPE & Acc.
4. IPS, PIP Pipe & Acc.
5. SURFACE
6. SPRINKLERS
7. TRAVELER & WHEEL MOVE
8. PIVOT
9. TURF
10. LOW VOLUME
11. FILTERS
12. INJECTION
13. HARDWARE
INDEX

RAIN BIRD® ROTORS

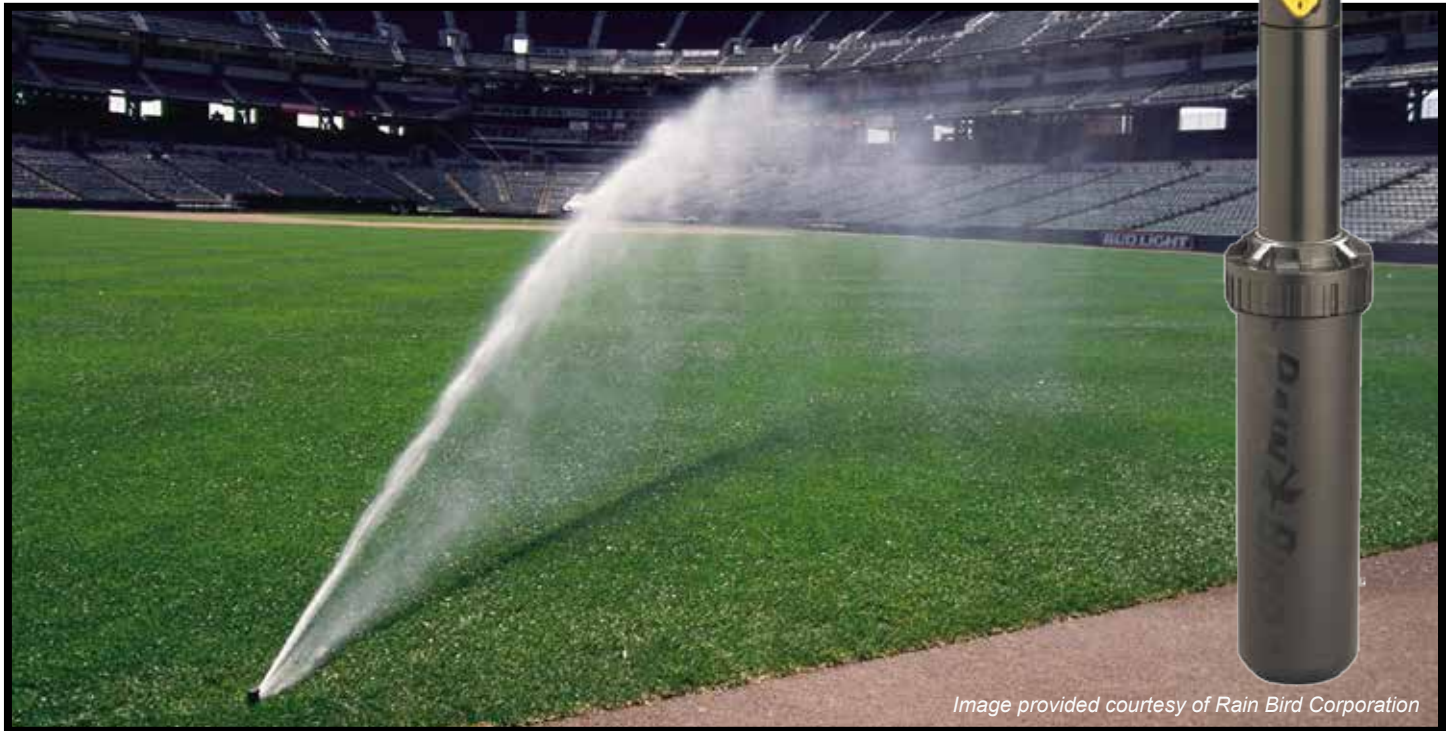

Image provided courtesy of Rain Bird Corporation

RAIN BIRD® ROTORS APPLICATIONS AND FEATURES

Major Products	Closed Case Rotors					Open Case Rotor
Primary Applications	3500 Series	5000 & 5000 Plus Series	5500 Series	8005	Falcon™	2045A Maxi-Paw™
Residential	•	•				
Commercial			•	•	•	•
Vandalism/Damage Prone Areas			•	•	•	•
Slopes	•	•	•	•	•	•
Ground Cover/Shrubs	•	•				
High Wind Areas	•	•	•	•	•	•
Taller Turfgrass		•	•	•		
Non-potable Water*	•	•	•	•	•	•
Full Circle Available	•	•	•	•	•	•
Rain Curtain™ Nozzle Tree Included **	•	•				
Nozzle Included Must Specify Size			•	•	•	•
SAM™ Option Available***	•	•	•	•	•	•
Optional PRS Feature****		•				
Optional Stainless Steel Riser		•	•	•	•	
Pop-Up Heights Available	4"	Shrub, 4", 6", 12"	5", 12"	5"	4"	2-3/4"
Radius Range	15' - 35'	25' - 50'	17' - 55'	57' - 81'	39' - 65'	22' - 45'
Part Circle Radius Range	40° - 360°	40° - 360°	50° - 330°	50° - 330°	40° - 360°	20° - 340°
Radius Adjustment	25%	25%			25%	
Recommended Pressure (PSI)	25 - 55	25 - 65	30 - 90	50 - 100	30 - 90	25 - 60
Flow Rate (GPM)	.54 - 4.66	.73 - 9.63	1.2 - 15.5	11.1 - 36.3	2.9 - 21.7	1.5 - 8.4
Precipitation Rate (In./Hr.)	.37 - .83	.2 - 1.01	.21 - 1.48	.66 - 1.23	.37 - 1.14	.23 - 1.05
Inlet Thread (FIPT)	1/2"	3/4"	3/4"	1"	1"	1/2", 3/4"

* Optional non-potable cover for easy identification of reclaimed water.

**Rain Curtain™ nozzles feature: Large droplets for consistent performance, effective close-in watering and even distribution over the entire radius.

*** Optional Seal-O-Matic™ (SAM™) check valve holds up to 7 feet (10' in the 5500, 7005, 8005, Falcon & Maxi-Paw™ series sprinkler) of elevation change, to prevent puddling and erosion caused by low head drainage.

**** Optional Pressure Regulating Stem (PRS) reduces operating pressure to 45 PSI which helps to eliminate head-to-head pressure variation and eliminate misting due to high pressure.

RAIN BIRD® ROTORS

3500 SERIES ROTOR

Part No.	Description	Price
3504PC	4" Part/Full Circle Reversing	
3504PCSAM	4" Part/Full Circle Reversing w/ SAM	
3504PCSAMNP	4" Part/Full Circle Reversing w/ SAM & NP Cover	

Pop-Up Height 4" - 1/2" FIPT Inlet



5000 SERIES ROTOR

Part No.	Description	Price
5004PC	4" Part/Reverse Full Circle	
5004FC	4" Full Circle	
5004PCSAM	4" Part/Reverse Full Circle w/SAM	
5004FCSAM	4" Full Circle w/SAM	
5004PLPCSNP	4" Part/Reverse Full Circle w/SAM & NP Cover	
5004PLFCSNP	4" Full Circle w/SAM & NP Cover	
5006PC	6" Part/Reverse Full Circle	
5012PC	12" Part/Reverse Full Circle	

Pop-Up Height 4", 6" 12" & Shrubs - 3/4" FIPT Inlet



5000 PLUS SERIES SHRUB ROTOR

Part No.	Description	Price
5000SPLPCS	Shrub Part Circle w/SAM	
5000SPLFCS	Shrub Full Circle w/SAM	
5000SPLPCSNP	Shrub Part Circle w/SAM & NP Cover	
5000SPLFCSNP	Shrub Full Circle w/SAM & NP Cover	

Pop-Up Height Shrubs - 3/4" FIPT Inlet



5500 SERIES ROTOR

Part No.	Description	Price
5505	5" Part/Full Circle w/SAM (incl. 2, 4, 6, 8 Noz.)	
5505NP	5" Part/Full Circle w/SAM & NP Cover (incl. 2, 4, 6, 8 Noz.)	
5505SS	5" Part/Full Circle, Stainless Steel w/SAM (incl. 2, 4, 6, 8 Noz.)	
5505SSNP	5" Part/Full Circle, Stainless Steel w/SAM & NP Cover (incl. 2, 4, 6, 8 Noz.)	
5500NOZ	Nozzles for 5500 Series (2, 3, 4, 5, 6, 8, 10, 12)	



INTRO
1. ELECTRICAL
2. PUMP ACC.
3. HOSE, PE PIPE & ACC.
4. IPS, PIP PIPE & ACC.
5. SURFACE
6. SPRINKLERS
7. TRAVELER & WHEEL MOVE
8. PIVOT
9. TURF
10. LOW VOLUME
11. FILTERS
12. INJECTION
13. HARDWARE
INDEX

RAIN BIRD® ROTORS

RAIN BIRD® FALCON® 6504 SERIES ROTOR

Part No.	Description	Price
F4PC	Part Circle, Less Nozzle	
F4FC	Full Circle, Less Nozzle	
F4PCNP	Part Circle, Less Nozzle w/NP Cover	
F4FCNP	Full Circle, Less Nozzle w/NP Cover	
F4PCSS	Part Circle, Stainless Steel, Less Nozzle	
F4FCSS	Full Circle, Stainless Steel, Less Nozzle	
F4PCSSNP	Part Circle, w/NP Cover & SS, Less Nozzle	
F4FCSSNP	Full Circle, w/NP Cover & SS, Less Nozzle	
F4PCSSHS	Part Circle, SS High Speed, Less Nozzle	
F4FCSSHS	Full Circle, SS High Speed, Less Nozzle	
COMRAINNOZ	Nozzles for Falcon 6504 (4, 6, 8, 10, 12, 14, 16, 18)	



RAIN BIRD® 8005 SERIES ROTOR

Part No.	Description	Price
8005	Part/Full Circle, Less Nozzle	
8005NP	Part/Full Circle, Less Nozzle w/NP Cover	
8005SS	Part/Full Circle, Stainless Steel, Less Nozzle	
8005SSNP	Part/Full Circle, Stainless Steel, Less Nozzle w/NP Cover	
8005RCNOZ	Nozzles for 8005 (12, 14, 16, 18, 20, 22, 24, 26)	



RAIN BIRD® IMPACT ROTORS

RAIN BIRD® 2045A MAXI-PAW™

Part No.	Description	Price
2045A08	Part/Full Circle Maxi-Paw	
2045A08NP	Part/Full Circle Maxi-Paw Non-Potable	
2045ASAM08	Part/Full Circle Maxi-Paw SAM	
2045ASAMNP08	Part/Full Circle Maxi-Paw SAM Non-Potable	



HUNTER® ROTORS



HUNTER® ROTORS APPLICATIONS AND FEATURES

Primary Applications	SRM	PGJ	PGP	PGP Ultra	I-20	I-25	I-35	I-40	I-90
Residential	•	•	•	•	•				
Commercial / Institutional				•	•	•	•	•	•
Athletic Fields					•	•	•	•	•
High Vandalism Areas					•		•	•	
Low Pressure Systems		•	•						
Riser-Mounted Sprinklers		•	•		•				
Ground Cover and/or Shrub		•	•		•				
Nozzle Tree Included	•	•	•	•	•	•	•	•	•
Optional Factory Installed Nozzles	3.0 Only	2.0 Only			•	•	•	•	•
Optional Low Angle Nozzles			•	•	•				
Optional Drain Check Valve*	•	•	•	•	•	•	•	•	•
Optional Non-potable Water Cover		•	•	•	•	•	•	•	•
Optional Stainless Steel Riser					•	•	•	•	•
Optional High Speed Version							•	•	
Pop-Up Sizes Available	4"	Shrub, 4", 6", 12"	Shrub, 4", 12"	4", 12"	Shrub, 4", 6", 12"	4", 6"	6"	4", 6"	3"
Radius Range	15' - 30'	15' - 37'	22' - 52'	17' - 47'	17' - 46'	37' - 71'	47' - 71'	41' - 76'	63' - 104'
Adjustable Arc Range	40° - 360°	40° - 360°	40° - 360°	50° - 360°	50° - 360°	50° - 360°	50° - 360°	50° - 360°	40° - 360°
Recommended Pressure Range (PSI)	30 - 50	30 - 50	25 - 70	25 - 70	30 - 70	40 - 100	40 - 100	40 - 100	60 - 100
Flow Rate (GPM)	.42 - 3.4	.64 - 5.3	.5 - 14.1	.36 - 14.8	1.2 - 9.8	3.8 - 31.5	7.7 - 31.5	7 - 33.7	22 - 83
Precipitation Rate (In./Hr.)	.36 - .84	.55 - .86	.12 - 1.16	.21 - 1.37	.27 - 1.37	.46 - 1.66	.67 - 1.66	.39 - 1.54	.52 - 2.0
Inlet Thread (FIPT)	1/2"	1/2"	3/4"	3/4"	3/4"	1"	1"	1"	1-1/2"

* The optional Drain Check Valve prevents unwanted and wasteful puddling and erosion that occurs from low head drainage due to elevation variations. The check valve protects the PGV series from up to 7 feet of elevation change and up to 10 feet in all other rotor series heads.

INTRO | 1. ELECTRICAL | 2. PUMP ACC. | 3. HOSE, PE PIPE & ACC. | 4. IPS, PIP PIPE & ACC. | 5. SURFACE | 6. SPRINKLERS | 7. TRAVELER & WHEEL MOVE | 8. PIVOT | 9. TURF | 10. LOW VOLUME | 11. FILTERS | 12. INJECTION | 13. HARDWARE | INDEX

HUNTER® ROTORS

SRM 4" POP-UP SPRINKLER

Part No.	Description	Price
SRM-04	Adjustable Arc, 6 Standard Nozzles	

PGJ SHRUB SPRINKLER

Part No.	Description	Price
PGJ-00	Shrub Body, Adjustable Arc, No Check Valve	

With 8 Standard Nozzles & 1/2" Inlet

PGJ 4" POP-UP SPRINKLER

Part No.	Description	Price
PGJ-04	4" Adjustable Arc, No Check Valve	

With 8 Standard Nozzles & 1/2" Inlet

PGJ 6" POP-UP SPRINKLER

Part No.	Description	Price
PGJ-06	6" Adjustable Arc, No Check Valve	

With 8 Standard Nozzles & 1/2" Inlet

PGJ 12" POP-UP SPRINKLER

Part No.	Description	Price
PGJ-12	12" Adjustable Arc, No Check Valve	

With 8 Standard Nozzles & 1/2" Inlet



PGP ULTRA SHRUB ROTOR

Part No.	Description	Price
PGP-00	Adjustable Arc 50° - 360°, No Check Valve	

PGP 4" POP-UP SPRINKLER

Part No.	Description	Price
PGP-ADJ	Adjustable Arc, No Check Valve	
PGP-04	Full-Circle, No Check Valve	

With 12 Standard Nozzles & 3/4" Inlet

PGP 12" POP-UP SPRINKLER

Part No.	Description	Price
PGP-12-CV	Adjustable Arc 50° - 360°, With Check Valve	

With 12 Standard Nozzles & 3/4" Inlet

Low Angle Nozzle Rack for PGP
STD Nozzle Rack for PGP



PGP-ATR, WITH 12 STANDARD NOZZLES

Part No.	Description	Price
PGP-ATR	Impact Replacement Gear Drive, w/Nozzle Set, No. 7 Nozzle factory-installed	
H42064	Wrench to Remove Impact Internal for Installation of PGP-ATR	



HUNTER® ROTORS

I-20 ULTRA, 4" POP-UP ROTOR

Part No.	Description	Price
I-20-04	Adjustable Arc 50° - 360°, No Check Valve	
I-20-04SS	Adj. Arc, with Stainless Steel Riser & Check Valve	

With 8 Standard and 4 Low Angle Nozzle & 1" Inlet



I-25 PLUS, 3-1/2" POP-UP ROTOR

Part No.	Description	Price
I25-04	Adjustable Arc 50-360°, Plastic riser with check valve	
I25-04-SS	Adjustable Arc 50-360°, Stainless Steel riser with check valve	

With 1" Inlet



I-25 PLUS, SPECIAL PURPOSE INSTITUTIONAL SERIES

Part No.	Description	Price
I25-04-SS-HS	High Speed Adjustable Arc 50-360°, Stainless Steel Riser with Check Valve	

I-40, 3-1/2" POP-UP ROTOR

Part No.	Description	Price
I40-04-SS	Adjustable Arc 50-360°, Stainless Steel Riser with Check Valve	

With 6 Nozzles & 1" Inlet



I-90, POP-UP ROTOR

Part No.	Description	Price
I-90-ADV	Adjustable Arc with Check Valve	
I-90-36V	Full Circle with Check Valve	

Large Area with 6 Nozzles and 1-1/2" Inlet



INTRO
1. ELECTRICAL
2. PUMP, ACC.
3. HOSE, PE PIPE & ACC.
4. IPS, PIP PIPE & ACC.
5. SURFACE
6. SPRINKLERS
7. TRAVELER & WHEEL MOVE
8. PIVOT
9. TURF
10. LOW VOLUME
11. FILTERS
12. INJECTION
13. HARDWARE
INDEX

SIGNATURE® GOLF ROTORS

- C Models : include factory-installed check valve.
- E Models : feature electric valve and head.
- H Models : are N.O. hydraulically controlled.
- B Compact Models : feature factory-installed drain valve.
- X-Series : are dual part-circle rotors with adjustable radii.

GOLF ROTOR - SPECIFICATIONS

Rotor Series	Operating Range	Max. Pressure	Min. Pressure	Discharge	Pop-Up Height	Check Valve	Body Height	Top Diameter	Inlet Size	# Per Box
Flange Body Series D50/55	50-80 PSI	100 PSI	40 PSI	11.0 to 31.3 GPM	4"	N/A	9-3/4"	6-1/2"	1" Female NPT, BSP, ACME	4 x D50/D55 C, E or H Series
Block Body Series D50/55B	50-70 PSI	100 PSI	40 PSI	11.0 to 31.3 GPM	4"	Holds back up to 15' difference in elevation	8-1/4"	6"	1" Female NPT, BSP, ACME	8 x D50/D55B, Series
D70/75 Series	60-100 PSI	100 PSI	40 PSI	11.0 to 31.3 GPM	4"		10-3/4"	7-1/2"	1-1/2" Female NPT, BSP, 1-1/4" Female ACME	4 x D70/75 Series

D50 SERIES GOLF ROTORS - (FULL CIRCLE, SHORT TO MEDIUM RANGE 37-72 FT)

Part No.	Description	Price
D50C25A	1" Full Circle Rotor with Check Valve, ACME	
D50E2570A	1" Full Circle Rotor, Electric VIH, ACME	
D50H25A	1" Full Circle Rotor, Hydraulic VIH, ACME	
D50B25A	1" Full Circle Block Rotor, with Drain Valve ACME	

D55 SERIES GOLF ROTORS - (PART CIRCLE, SHORT TO MEDIUM RANGE 37-67 FT)

Part No.	Description	Price
D55C25A	1" Part Circle Rotor with Check Valve, ACME	
D55E2570A	1" Part Circle Rotor, Electric VIH, ACME	
D55H25A	1" Part Circle Rotor, Hydraulic VIH, ACME	
D55B25A	1" Part Circle Block Rotor, with Drain Valve ACME	
D55XC2514A	1" X-Series Rotor with Check Valve, ACME	
D55XE251470A	1" X-Series Rotor, Electric VIH, ACME	
D55XH2514A	1" X-Series Rotor, Hydraulic VIH, ACME	

- Pressure Regulation (Electric Model Only) 60, 70 (Standard Pressure), or 80 PSI
- Inlet thread availability; NPT, BSP, or ACME (Standard Stocking Item)
- Re-Claimed Water Versions Available



D70 SERIES GOLF ROTORS - (FULL CIRCLE, MEDIUM RANGE 67-93 FT)

Part No.	Description	Price
D70C50A	1-1/2" Full Circle Rotor with Check Valve, ACME	
D70E5080A	1-1/2" Full Circle Rotor, Electric VIH, ACME	
D70H50A	1-1/2" Full Circle Rotor, Hydraulic VIH, ACME	

D75 SERIES GOLF ROTORS - (PART CIRCLE, MEDIUM RANGE 67-73 FT)

Part No.	Description	Price
D75C32A	1-1/2" Part Circle Rotor with Check Valve, ACME	
D75E3280A	1-1/2" Part Circle Rotor, Electric VIH, ACME	
D75H32A	1-1/2" Part Circle Rotor, Hydraulic VIH, ACME	
D75XC3516A	1-1/2" X-Series Rotor with Check Valve, ACME	
D75XE351680A	1-1/2" X-Series Rotor, Electric VIH, ACME	
D75XH3516A	1-1/2" X-Series Rotor, Hydraulic VIH, ACME	

- Pressure Regulation (Electric Model Only) 60, 70, 80 (Standard Pressure), 90 or 100 PSI
- Inlet thread availability; NPT, BSP, or ACME (Standard Stocking Item)
- Re-Claimed Water Versions Available



ACCESSORIES

Part No.	Description	Price
D001	Snap ring/pilot valve tool	
D002	Pilot valve key	
D004	1 1/4" ACME & 1 1/2" NPT/BSP valve insertion tool	
D038	Pressure gauge	



SIGNATURE® GOLF ROTORS INTERNAL ASSEMBLIES

SIGNATURE® REPLACEMENT INTERNALS

Part No.	Description	Price
D15025	D50 Replacement Internal, #25 Blue Nozzle	
D150B25	D50B Replacement Internal, #25 Blue Nozzle	
D15525	D55 Replacement Internal, #25 Blue Nozzle	
D155B25	D55B Replacement Internal, #25 Blue Nozzle	
D155x2514	D55X Replacement Internal, #25 Blue (Front) / #14 Yellow (Rear) Nozzle	
D17050	D70 Replacement Internal, #50 Black Nozzle	
D17532	D75 Replacement Internal, #32 Yellow Nozzle	
D175x3518	D75X Replacement Internal, #35 Yellow (Front) / #18 Brown (Rear) Nozzle	

DI5025



DI7532



RAIN BIRD® REPLACEMENT INTERNALS

Part No.	Description	Price
D147R25	Rain Bird® 47DR Replacement Internal, #25 Blue Nozzle	
D147RX2514	Rain Bird® 47DR X-Series Replacement Internal, #25 Blue (Front) / #14 Yellow (Rear) Nozzle	
D151R25	Rain Bird® 51DR Replacement Internal, #25 Blue Nozzle	
D1700R25	Rain Bird® 700DR Replacement Internal, #25 Blue Nozzle	
D1750R25	Rain Bird® 750DR Replacement Internal, #25 Blue Nozzle	
D1750RX2514	Rain Bird® 750 X-Series Replacement Internal, #25 Blue (Front) / #14 Yellow (Rear) Nozzle	

DI47R25



TORO® REPLACEMENT INTERNALS

Part No.	Description	Price
D16734T25	1" Toro® 630/730, 660/760 Insert, #25 Blue Nozzle	
D16735T25	1" Toro® 635/735, 665/765 Insert, #25 Blue Nozzle	
D16735TX25	1" Toro® 630, 660, 730, 760 X Series Insert, #25 Blue (Front) / 14 Yellow (Rear) Nozzle	
D16785T26	1" Toro® 650/750, 680/780 Insert, #26 Blue Nozzle	
D16785TX16	1-1/2" Toro® 650/750, 680/780 X Series Insert, #30 Yellow (Front) / 16 Orange (Rear) Nozzle	
D1674754T50	1-1/2" Toro® 650/750, 680/780 X Series Insert, #50 Black Nozzle	
D1694T50	1-1/2" Toro® 690, Insert, #50 Black Nozzle	
D1834T25	1" Toro® 830/860, Insert, #25 Blue Nozzle	
D1865T25	1" Toro® 835/865, Insert, #25 Blue Nozzle	

DI6735T25



DI694T50



REPLACEMENTS FOR TORO®:

1" Inlet Bodies

DI6734T Full-circle,
DI6735T Part-circle,
DI865T Part-circle
Radius: 52'-75'
Flowrate: 11.0-35.5 GPM
Replacement Upgrades for:
TORO® 630, 660, 730, 760 and 830, 860

1½" Inlet Bodies

DI674754T Full-circle
Radius: 66'-100'
Flowrate: 25.1-66.0 GPM
Replacement Upgrade for:
TORO® 650, 670, 680, 750, 780
DI6785T Part-circle
Radius: 56'-82'
Flowrate: 13.0-35.3 GPM
Replacement Upgrade for:
TORO® 650, 680, 750, 780
DI694T Full-circle
Radius: 91'-100'
Flowrate: 57.0-66.0 GPM
Replacement Upgrade for: Toro 690

REPLACEMENTS FOR Rain Bird®:

1¼" Inlet Bodies

DI700R Full-circle,
DI750R Part-circle
Radius: 53'-72'
Flowrate: 12.5-33.0 GPM
Replacement Upgrades for:
Rain Bird® Eagle 700, Eagle 750

1½" Inlet Bodies

DI51R Full-circle, DI47R Part-circle
Radius: 53'-72'
Flowrate: 12.5-33.0
GPM Replacement Upgrades for:
Rain Bird® 47D, 51D

INTRO
 1. ELECTRICAL
 2. PUMP, ACC.
 3. HOSE, PE PIPE & ACC.
 4. IPS, PIP PIPE & ACC.
 5. SURFACE
 6. SPRINKLERS
 7. TRAVELER & WHEEL MOVE
 8. PIVOT
 9. TURF
 10. LOW VOLUME
 11. FILTERS
 12. INJECTION
 13. HARDWARE
 INDEX

RAIN BIRD® BRASS IMPACT SPRINKLERS & NOZZLES

RAIN BIRD® FULL CIRCLE IMPACT SPRINKLERS

Part No.	Description	Price
A06015	L20H 1/2" Male Brass Single Nozzle 23°	
A05840	20JH 1/2" Male Brass Single Nozzle 23°	
A06501	29JH 1/2" Male Brass Single Nozzle 23°	
A11640	L3030H 3/4" Male Brass Double Nozzle 10°	
A08401	30H 3/4" Male Brass Double Nozzle 27°	
A08411	30WH 3/4" Male Brass Single Nozzle 27°	
A12800	14070H 3/4" Male Brass Double Nozzle 27°	
A20000	70CH 1" Female Brass Double Nozzle 21°	
A20030	70CHM 1" Male Brass Double Nozzle 21°	
A23802	80EHD 1-1/4" Male Brass Double Nozzle 27°	



RAIN BIRD® PART OR FULL CIRCLE IMPACT SPRINKLERS

Part No.	Description	Price
A34403	25BPJ-FP-ADJ-DA-TNT 1/2" Male Brass Impact, PJ Arm, with Diffuser & Distance Control and 5/32" Nozzle	
A32901-XX	25BPJ-FP-ADJ 1/2" Male Brass Impact with PJ Arm, Adjustable Breakup Pin, and SBN Nozzle	
A39200	35A-TNT 3/4" Male Brass Impact Less Nozzle	
A4061312	35A-PJ-ADJ-TNT 3/4" Male Brass Impact with PJ Arm & ADJN-3 Nozzle	
AG2001	65PJ-TNT 1" Female Brass Impact with PJ Arm, Less Nozzle	
A23600	85EHD 1-1/4" Male Brass Impact, Less Nozzles 27°	
A23960	85EHD-LA 1-1/4" Male Brass Low Angle Impact, Less Nozzle 17°	



RAIN BIRD® NOZZLES & ACCESSORIES FOR IMPACT SPRINKLERS

Part No.	Description	Price
100226-xx	LAN-1-20 Brass 20° Low Angle Nozzle 1/2" Body & Spreader Nozzle for 3/4" Bodies & 808A	
105780-xx	SBN-1 Brass Straight Bore Nozzle for 1/2" Body	
105842-xx	SBN-3 Brass Straight Bore Nozzle for 3/4" Body	
100382-xx	SBN-4 Brass Straight Bore Nozzle for 1" Body	
103043-xx	SBN-5 Brass Straight Bore Nozzle for 1-1/4" Body	
100418	SPB-1 Spreader Bushing for 1" Body	
101092-xx	ADJN-1V Brass Adjustable Nozzle w/Vane for 1/2" Body	
100328-xx	ADJN-3 Brass Adjustable Nozzle for 3/4" Body	
100385-xx	ADJN-4 Brass Adjustable Nozzle for 1" Body	
100255	Brass Plug for 1/2" Body	
100289	Brass Plug for 3/4" Body (Range)	
100417	Brass Plug for 1" Body (Spreader Side)	



NELSON BRASS IMPACT SPRINKLERS & NOZZLES

NELSON FULL CIRCLE IMPACT SPRINKLERS

Part No.	Description	Price
6902	F33AS 3/4" Male Brass Single Nozzle 15°	
6717	F33AA 3/4" Male Brass Double Range Nozzle 15°	
6903	F43A 3/4" Male Brass Double Nozzle 15°	
7316	F70M 1" Male Brass Double Nozzle 25°	
7118	F70AM 1" Male Brass Double Nozzle 15°	
8732	F80 1-1/4" Male Brass Double Nozzle 24°	
7155	F80A 1-1/4" Male Brass Double Nozzle 18°	

Less Nozzle

NELSON PART OR FULL CIRCLE BRASS IMPACT SPRINKLERS

Part No.	Description	Price
8805	P65M 1" Male Single Nozzle 24°	
8426	P85 1-1/4" Male Double Nozzle 24°	
7697	P85A 1-1/4" Male Double Nozzle 18°	
8079	P85AS 1-1/4" Male Single Nozzle 18°	

Less Nozzle

NELSON NOZZLES & PLUGS

Part No.	Description	Price
3RN	Brass Nozzle for 3/4" Impacts	
3FCN	Flow Control Nozzle for F33AS, F33AA & F44AAB	
7RN	Drive Nozzle F70M, F70AM & P65M	
8DRN	Drive Nozzle F80, F80A, P85, P85A & P85AS	
3RN PLUG	Brass Secondary Plug for F70A, F80A, P85, F44AAB	



WEATHER-TEC BRASS IMPACT SPRINKLERS

WEATHER-TEC FULL CIRCLE BRASS IMPACT SPRINKLERS

Part No.	Description	Price
10-20G	1/2" Male Single Nozzle 23° with Nozzle	
10-30G	3/4" Male Single Nozzle 23° with Nozzle	
10-30DG	3/4" Male Double Nozzle 23° with Nozzle	
10-30LDG	3/4" Male Double Nozzle 15° with Nozzle	
10-67G	1" Male Single Nozzle 23° with Nozzle	
10-80K	1-1/4" Male Single Nozzle 23° with Nozzle	



WEATHER-TEC PART OR FULL CIRCLE BRASS IMPACT SPRINKLERS

Part No.	Description	Price
15-20KAFF	1/2" Male Single Nozzle 23° with Nozzle	
15-20LKFP	1/2" Male Single Nozzle 23° available with either 7°, 12°, 15°, 18° or 20° Low Angle Nozzle	
15-30KFP	3/4" Male Single Nozzle 27° with Nozzle	
15-67KAFF	1" Male Double Nozzle 23° with Nozzle	
15-80KFP	1-1/4" Male Double Nozzle 23° with Nozzle	
15-80LK	1-1/4" Male Double Nozzle 15° with Nozzle	



XCAD BRASS AND MULTI-COMPOSITE™ IMPACT SPRINKLERS & NOZZLES

XCAD AQUA BURST® FULL CIRCLE IMPACTS

Part No.	Description	Nozzle Guide	Price
AL1023	1/2" Male Multi-Composite Single Nozzle 10° or 23°	NOZ5R	
AL1023W	1/2" Male Multi-Composite Wedge Drive Single Nozzle 10° or 23°	NOZ5R	
HF20	1/2" Full Circle Brass	NOZ75	
HF30	3/4" Male Brass Single Nozzle 23°	NOZ75	
HF30-C	3/4" FC Brass Arm, Single Nozzle W/Chrome Bearing	NOZ75	
HF30D	3/4" Male Brass Double Nozzle 26°	NOZ75	
HF30D-C	3/4" FC Brass Arm, Double Nozzle W/Chrome Bearing	NOZ75	
HF30AL	3/4" Male Brass Aluminum Arm Single Nozzle 26°	NOZ75	
AL30	3/4" Brass Brg., Plastic Body, Alum. Arm Dbl. Noz. 26°	NOZ75	
X65F-S	1" Male Brass Single Nozzle 24° with Spoon	NOZ1	
X85F24	1-1/4" Male Brass Single Nozzle 24°	NOZ125	



XCAD AQUA BURST® PART OR FULL CIRCLE IMPACTS

Part No.	Description	Price
X25ED	1/2" Male Multi-Composite Single Nozzle Anti-Backsplash Arm 23°	
X25EDS	1/2" Male Multi-Composite Single Nozzle STD. Spoon Arm 23°	
X35ED	3/4" Male Brass Single Nozzle 25°	
X65ED-S	1" Male Brass w/Spoon Single Noz. 24°	
X85ED18	1-1/4" Male Brass Dual Nozzle 18°	
X85ED24	1-1/4" Male Brass Dual Nozzle 24°	



XCAD AQUA BURST® ADVANCED FLOW NOZZLES & ACCESSORIES

Part No.	Description	Price
NOZ5R	Brass Straight Bore Nozzle for 1/2" Impacts Fits Aqua Burst® AB20 Series	
NOZ5W	Brass Straight Bore Nozzle for 1/2" Impacts Fits Aqua Burst® RB Series	
NOZ75	Brass Straight Bore Nozzle for 3/4" Impacts Including 1/2" Aqua Burst® RB29F	
NOZ1	Brass Straight Bore Nozzle for 1" Impacts	
NOZ-BKSPRD	Brass Spreader Nozzle 1/8" NPT (3/32" or 1/8")	
NOZPL75	1/4" NPT Straight Bore Nozzle	
NOZ-PLG18	Brass Plug 1/8" NPT	
NOZ-PLG25	Brass Plug 1/4" NPT	
NOZPLPLG18	Plastic Plug 1/8" NPT	
NOZPLPLG25	Plastic Plug 1/4" NPT	
NOZ125	Fits 1-1/4" Impact 11/32, 3/8, 13/32, 7/16, 15/32, 1/2", 17/32, 9/16, 5/8, 11/16	
HF20BRNG	Brass Bearing Assembly for 1/2" AB Series	
HF30BRG	Brass Bearing Assembly for 3/4" Impacts	
X65BRNG	Brass Bearing Assembly for 1" Impacts	
X85BRG	1-1/4" Bearing Assembly, Fits Aqua Burst & Rainbird	



XCAD AQUA BURST NOZZLE MULTI-TOOL

Part No.	Description	Price
NOZTOOL	Nozzle Tool for 3/4" Sprinkler	
NOZTOOL.5	Nozzle Tool for 1/2" Sprinkler	

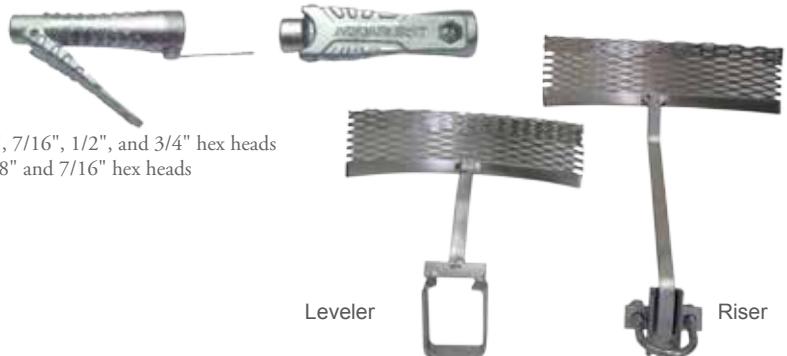

Nozzle Tool Features:

- All stainless steel construction
- EZ grip handles
- Stainless steel nozzle plug wire
- NOZTOOL fits nozzles with 3/8", 7/16", 1/2", and 3/4" hex heads
- NOZTOOL.5 fits nozzles with 3/8" and 7/16" hex heads

ROAD GUARDS (MADE IN THE USA)

Part No.	Description	Price
RGS75P	Wheelline / Leveler	
RGCS100	Handline / Riser	

Leveler

Riser

RAIN BIRD® BRASS QUICK COUPLING VALVES, KEYS & SWIVEL ELLS

RAIN BIRD® QUICK COUPLING VALVES

Part No.	Description	Case Qty.	Price
3RC	1-Piece Body, 3/4" Inlet Rubber Cover	15	
44RC	2-Piece Body, 1" Inlet Rubber Cover	8	
5RC	1-Piece Body, 1" Inlet Rubber Cover	10	
7	1-Piece Body, 1-1/2" Inlet with Standard Cover	8	



RAIN BIRD® QUICK COUPLING VALVE KEYS

Part No.	Description	Case Qty.	Price
33DK	Key, 3/4" MIPT x 1/2" FIPT Top, Double Lug	10	
44K	Key, 1" MIPT x 3/4" FIPT Top Threads	10	
55K1	Key, 1" MIPT Top Threads	15	
7K	Key, 1-1/2" MIPT x 1-1/4" FIPT Top Threads	8	



RAIN BIRD® SWIVEL HOSE ELL

Part No.	Description	Case Qty.	Price
SH0	3/4" FIPT x 3/4" Hose Threads	10	
SH1	1" FIPT x 3/4" Hose Threads	10	
SH2	1" FIPT x 1" MIPT Threads	30	
SH3	1-1/2" FIPT x 1" Hose Threads	8	



HUNTER® BRASS QUICK COUPLING VALVES, KEYS & SWIVEL ELLS

HUNTER® HQ QUICK COUPLING VALVES

Part No.	Description	Case Qty.	Price
HQ-3RC	3/4" FNPT Inlet, 2 Slots, 1 Piece Body	10	
HQ-44RC	1" FNPT Inlet, 1 Slot, 2 Piece Body	10	
HQ-5RC	1" FNPT Inlet, 2 Slots, 1 Piece Body, 1-1/4" Keyway Outlet	10	



HUNTER® QUICK COUPLING VALVE KEYS

Part No.	Description	Case Qty.	Price
HK-33	3/4" Single Lug Inlet, Combination 3/4" MNPT / 1/2" FNPT Outlet	10	
HK-44	1" Single Stainless Lug Inlet, Combination 1" MNPT / 3/4" FNPT Outlet	10	
HK-55	1-1/4" Single Stainless Lug Inlet, 1" MNPT Outlet	10	



HUNTER® SWIVEL HOSE ELL

Part No.	Description	Case Qty.	Price
HS-0	3/4" FNPT x 3/4" Male Hose Outlet	10	
HS-1	1" FNPT x 3/4" Male Hose Outlet	10	
HS-2	1" FNPT x 1" Male Hose Outlet	10	



SWING JOINTS

RAIN BIRD® SWING ASSEMBLIES FOR SPRAY HEADS

Part No.	Description	Price
SA6050	1/2" x 1/2" x 6" Swing Assembly	
SA125050	1/2" x 1/2" x 12" Swing Assembly	
SA185050	1/2" x 1/2" x 18" Swing Assembly	
SA127575	3/4" x 3/4" x 12" Swing Assembly	
SA125075	1/2" x 3/4" x 12" Swing Assembly	



HUNTER® SJ SERIES SWING JOINT ASSEMBLIES

Part No.	Description	Price
SJ-506	1/2" x 6" Standard Swing Joint 4 Swing Elbows	
SJ-512	1/2" x 12" Standard Swing Joint 4 Swing Elbows	
SJ-712	3/4" x 12" Standard Swing Joint 4 Swing Elbows	



RAIN BIRD® TSJ SERIES SWING JOINT ASSEMBLIES

Part No.	Description	Price
TSJ12	12" Long, 1" M x M NPT Swing Joint	
TSJ18	18" Long, 1" M x M NPT Swing Joint	
TSJ12150	12" Long, 1-1/2" M x M NPT Swing Joint	
TSJ12075	12" Long, 3/4" M x M NPT Swing Joint	
TSJ075PRS	12" Long, 3/4" M x M NPT Swing Joint w/45 PSI Pressure Regulator	
TSJ100PRS	12" Long, 1" M x M NPT Swing Joint w/70 PSI Pressure Regulator	



KBI TSA SERIES SWING JOINT ASSEMBLIES

Part No.	Size	Description	Price
TSA-0750-TT	3/4" x 10"	MIPT x MIPT Swing Joint	
TSA-1000-TT	1" x 12"	MIPT x MIPT Swing Joint	
TSA-1250-TT	1-1/4" x 12"	MIPT x MIPT Swing Joint	
TSA-1500-TT	1-1/2" x 12"	MIPT x MIPT Swing Joint	



SPEARS SWING JOINT ASSEMBLIES

Part No.	Size	Description	Price
5805-01012	1" x 12"	Soc x MIPT Swing Joint	
5805-01212	1-1/4" x 12"	Soc x MIPT Swing Joint	
5805-01512	1-1/2" x 12"	Soc x MIPT Swing Joint	
5807-01008	1" x 8"	MIPT x MIPT Swing Joint	
5807-01012	1" x 12"	MIPT x MIPT Swing Joint	
5807-01212	1-1/4" x 12"	MIPT x MIPT Swing Joint	
5807-01512	1-1/2" x 12"	MIPT x MIPT Swing Joint	
5907-01000	1"	MIPT x MIPT Assembly w/o Nipple	
5907-01200	1-1/4"	MIPT x MIPT Assembly w/o Nipple	
5907-01500	1-1/2"	MIPT x MIPT Assembly w/o Nipple	



SPEARS® POLYETHYLENE SCH. 40 NIPPLE

Diameter →		1/2"		3/4"	
Diameter Code →		P42		P43	
Length	Length Code	Part No.	Price	Part No.	Price
CL	005	P42-005		P43-005	
2"	020	P42-020		P43-020	
3"	030	P42-030		P43-030	
4"	040	P42-040		P43-040	
5"	050	P42-050		P43-050	
6"	060	P42-060		P43-060	
8"	080	P42-080		P43-080	
10"	100	P42-100		P43-100	
12"	120	P42-120		P43-120	

SPEARS® POLY CUT-OFF NIPPLE

Part No.	Size	Color	Price
491-060	1/2" x 6"	Black	
493-060	3/4" x 6"	Black	
492-060	1/2" x 3/4" x 6"	Black	

SPEARS® 4 IN 1 POLY CUT-OFF NIPPLE

Part No.	Size	Color	Price
M481-005	1/2" x 6"	Green	
M481-007	3/4" x 6"	Green	
M481-101	3/4" x 1/2" x 6"	Green	

KBI POLY MULTI CUT-OFF NIPPLE

Part No.	Size	Color	Price
MCO-0500	1/2" x 6"	Black	
MCO-0750	3/4" x 6"	Black	
MCO-0750-R	1/2" x 3/4" x 6"	Black	

KBI POLY CUT-OFF RISER EXTENSION

Part No.	Size	Color	Price
CRE-0500-3	1/2" x 3"	Black	
CRE-0750-4	3/4" x 4"	Black	

KBI FLEX CUT-OFF NIPPLE

Part No.	Size	Color	Price
FCO-0500	1/2" x 6"	Black	
FCO-0750-R	1/2" x 3/4" x 6"	Black	

KBI FLEXIBLE VINYL NIPPLE

Part No.	Size	Connection	Price
FVN-0500-4	1/2" x 4"	MIPT x MIPT	
FVN-0500-4F	1/2" x 4"	MIPT x FIPT	
FVN-0500-6	1/2" x 6"	MIPT x MIPT	
FVN-0500-6F	1/2" x 6"	MIPT x FIPT	

COBRA CONNECTOR™ FLEXIBLE RISERS

Part No.	Description	Price
CC-1200	1/2" x 1/2" x 12" Flexible Riser	
CC-1275-2	3/4" x 3/4" x 12" Flexible Riser	



INTRO
1. ELECTRICAL
2. PUMP ACC.
3. HOSE, PE PIPE & ACC.
4. IPS, PIP PIPE & ACC.
5. SURFACE
6. SPRINKLERS
7. TRAVELER & WHEEL MOVE
8. PIVOT
9. TURN
10. LOW VOLUME
11. FILTERS
12. INJECTION
13. HARDWARE
INDEX

PVC IPS FLEX HOSE & POLYETHYLENE SWING PIPE

FLEXIBLE PVC HOSE

Part No.	Description	I.D.	O.D.	Price
11210008	1/2" IPS Flex PVC x 100'	.546"	.840"	
11210061	3/4" IPS Flex PVC x 100'	.742"	1.050"	
11210042	1" IPS Flex PVC x 100'	.957"	1.315"	

Use Flexible PVC Solvent Only - IPS #795 or Equivalent



RAIN BIRD® SWING PIPE (FUNNY PIPE) FOR SPRAY HEADS

Part No.	Description	I.D.	PSI	Price
SPXFLEX100	100' Coil Extra Flexible	.49"	80 PSI	



HUNTER® SWING PIPE (FUNNY PIPE) FOR SPRAY HEADS

Part No.	Description	Price
HFT-100	Hunter Flexible Swing Pipe - 100' Coil	
FLEXSG	Professional - Extra Flexible Swing Pipe - 100' Coil	
FLXSG-18	Precut 18" Proflex Segments	



SPIRAL BARBED FITTINGS

RAIN BIRD® SPIRAL BARBED FITTINGS

Part No.	Description	Price
SBE050	1/2" MNPT x 1/2" Barb Elbow	
SBE075	3/4" MNPT x 1/2" Barb Elbow	
SBA050	1/2" MNPT x 1/2" Barb Adapter	
SBA075	3/4" MNPT x 1/2" Barb Adapter	
SBCPLG	1/2" Barb x Barb Coupling	
SBTEE	1/2" Barb x Barb x Barb Tee	
SBFE050	1/2" FNPT x 1/2" Barb Elbow	



HUNTER® SPIRAL BARBED FITTINGS

Part No.	Description	Price
HSBE-050	1/2" MPT x Insert Poly Barb Elbow	
HSBE-075	3/4" MPT x Insert Poly Barb Elbow	
HSBETOOL	Installation Tool	



RAIN BIRD® CONTROL VALVES

RAIN BIRD® CONTROL VALVE APPLICATIONS AND FEATURES

Primary Applications	DV	DVF	JTV	PGA	PEB	PESB	GB	EFB-CP	BPE	BPES
Residential	*	*	*	*						
Commercial				*	*	*	*	*	*	*
Angle Type	*	*		*					*	*
Globe Type			*	*	*	*	*	*	*	*
Internal Bleed	*	*	*	*	*	*	*	*	*	*
External Bleed	*	*	*		*	*	*	*	*	*
Flow Control		*		*	*	*	*	*	*	*
Low Flow	*	*	*	*			*			
Reclaimed Water						*		*		*
Non-Potable Water				*	*	*	*		*	*
** PSR-D Compatible				*	*	*	*	*	*	*
Brass Body							*	*	*	*
PVC Body	*	*	*	*						
Glass Filled Nylon Body					*	*				
Optional Latching Solenoid	*	*	*	*	*	*	*	*	*	*
Optional Non-Potable Handle				*	*	*	*	*	*	*
Flow Ranges (GPM)	.2 - 40	.2 - 40	.25 - 30	2 - 150	.25 - 200	.25 - 200	5 - 200	5 - 200	60 - 300	60 - 300
Operating Pressure Ranges (PSI)	15 - 150	15 - 150	15 - 150	15 - 150	20 - 200	20 - 200	15 - 200	15 - 200	20 - 200	20 - 200
Inlet / Outlet Options (FIPT)	*	*	*	1", 1-1/2", 2"	1", 1-1/2", 2"	1", 1-1/2", 2"	1", 1-1/4" 1-1/2", 2"	1", 1-1/4" 1-1/2", 2"	3"	3"

* DV/DVF available in globe, slip x slip, male x male and male x barb configurations.
 DVF also available in union x union and union x barb configurations.
 JTV/JTVF available in 1" globe, slip x slip and male x barb configurations.
 ** PRS-D regulates pressure up to 100 PSI to help insure optimal sprinkler performance.

RAIN BIRD® DV SERIES VALVE

Part No.	Description	Case Qty.	Price
75DV	3/4" FIPT without Flow Control	20	
100DVF	1" FIPT with Flow Control	20	
100DV	1" FIPT without Flow Control	20	
100DVFSS	1" Slip with Flow Control	20	
100DVSS	1" Slip without Flow Control	20	



RAIN BIRD® JAR TOP VALVE

Part No.	Description	Case Qty.	Price
100JTV	1" Electric Valve 24 VAC FIPT x FIPT	20	
100JTVSS	1" Electric Valve 24 VAC Slip x Slip	20	
100JTVMB	1" Electric Valve 24 VAC Male x Barb	20	
BWJTV	JTV Series Bonnet Wrench	12	



RAIN BIRD® PGA GLOBE / ANGLE VALVE

Part No.	Description	Case Qty.	Price
100PGA	1" FIPT with Flow Control	10	
150PGA	1-1/2" FIPT with Flow Control	8	
200PGA	2" FIPT with Flow Control	4	

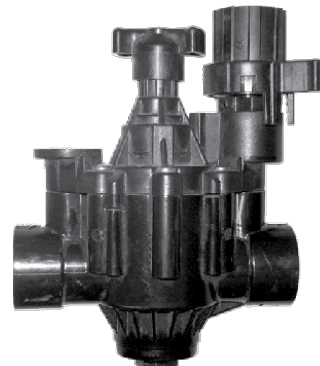

INTRO
 1. ELECTRICAL
 2. PUMP ACC.
 3. HOSE, PE PIPE & ACC.
 4. IPS, PIP PIPE & ACC.
 5. SURFACE
 6. SPRINKLERS
 7. TRAVELER & WHEEL MOVE
 8. PIVOT
 9. TURF
 10. LOW VOLUME
 11. FILTERS
 12. INJECTION
 13. HARDWARE
 INDEX

RAIN BIRD® CONTROL VALVES

RAIN BIRD® PEB & PESB GLOBE VALVE

Part No.	Description	Case Qty.	Price
100PEB	1" FIPT with Flow Control	10	
150PEB	1-1/2" FIPT with Flow Control	8	
200PEB	2" FIPT with Flow Control	8	
100PESB	1" FIPT with Scrubber & Flow Control	10	
150PESB	1-1/2" FIPT with Scrubber & Flow Control	8	
200PESB	2" FIPT with Scrubber & Flow Control	8	

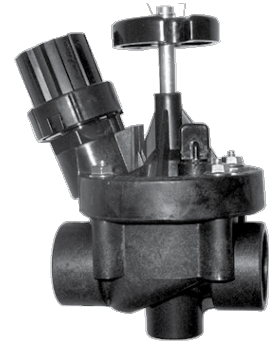

RAIN BIRD® 300BPE BRASS VALVE

Part No.	Description	Case Qty.	Price
300BPE	3" Electric Valve 24 VAC with Flow Control	1	
300BPES	3" Electric Valve 24 VAC Scrubber with Flow Control	1	



RAIN BIRD® EFB-CP SERIES BRASS VALVE

Part No.	Description	Case Qty.	Price
100EFBCP	1" Electric Valve 24 VAC with Flow Control	12	
125EFBCP	1-1/4" Electric Valve 24 VAC with Flow Control	12	
150EFBCP	1-1/2" Electric Valve 24 VAC with Flow Control	10	
200EFBCP	2" Electric Valve 24 VAC with Flow Control	8	



RAIN BIRD® REPLACEMENT SOLENOIDS

Part No.	Description	Case Qty.	Price
208588-01	DV and Jartop Replacement Solenoids	1	
236239	PE and PGA Valves Replacement Solenoids	1	



PRS-DIAL

Part No.	Description	Case Qty.	Price
PRSDIAL	Pressure Regulating Stem	10	



HUNTER® CONTROL VALVES

HUNTER® CONTROL VALVE APPLICATIONS AND FEATURES

Primary Applications	PGV-ASV	PGV	PGV-Jar Top	ICV	IBV
Residential	•	•	•		
Commercial				•	•
Angle Type	•	•		•	
Globe Type		•	•	•	•
Internal Bleed	•	•	•	•	•
External Bleed	•	•	•	•	•
Flow Control Option	•	•	•	•	•
Optional Latching Solenoid	•	•	•	•	
Optional Non-Potable Handle	•	•	•	•	•
Optional Accu-Set Pressure Regulator		•		•	•
Optional Drip Irrigation Kit	•	•	•	•	
Optional Filter Sentry				•	
Optional Solenoid Conduit Cover	•	•	•	•	
Flow Ranges (GPM)	1 - 30	.2 - 120	.2 - 30	.10 - 300	.10 - 300
Operating Pressure Range (PSI)	20 - 150	20 - 150	20 - 150	20 - 200	20 - 200
Inlet / Outlet Options	3/4", 1" FIPT or Slip	*	**	1", 1-1/2", 2", 3" FIPT	1", 1-1/2", 2", 3" FIPT

* Available in 1": Slip x Slip, FIPT x FIPT, MIPT x 1" Barb, MIPT x 1-1/4" Barb;
1-1/4": FIPT x FIPT and 2": FIPT x FIPT

** Available in 1": Slip x Slip, FIPT x FIPT, MIPT x MIPT, MIPT x 3/4" Barb,
MIPT x 1" Barb, MIPT x 1-1/4" BARB

HUNTER® PGV PROFESSIONAL GRADE VALVES

Part No.	Description	Case Qty.	Price
PGV-100G	1" Plastic Globe Valve, without Flow Control, FNPT Inlet and Outlet	20	
PGV-100G-S	1" Plastic Globe Valve, without Flow Control, Slip Inlet and Outlet	20	
PGV-101G	1" Plastic Globe Valve, with Flow Control, FNPT Inlet and Outlet	20	
PGV-151	1-1/2" Plastic Combination Globe Valve, with Flow Control, NPT Inlets	8	
PGV-100-JTGS	1" Plastic Globe Valve, Jar-Top Bonnet, without Flow Control, Female Slip Inlet and Outlet	20	
PGV-101-JTGS	1" Plastic Globe Valve, Jar-Top Bonnet, with Flow Control, Slip Inlet and Outlet	20	



HUNTER® PGV-ASV CONTROL VALVES

Part No.	Description	Case Qty.	Price
PGV-075-ASV	3/4" anti-siphon electric valve with flow control, NPT inlet/outlet	10	
PGV-101-ASV	1" anti-siphon electric valve with flow control, NPT inlet/outlet	10	
PGV-075-ASV-S	1" anti-siphon electric valve with flow control, NPT inlet/outlet	10	
PGV-101-ASV-S	1" anti-siphon electric valve with flow control, Slip inlet/outlet	10	



INTRO | 1. ELECTRICAL | 2. PUMP Acc. | 3. HOSE, PE PIPE & Acc. | 4. IPS, PIP Pipe & Acc. | 5. SURFACE | 6. SPRINKLERS | 7. TRAVELER & WHEEL MOVE | 8. PIVOT | 9. TURF | 10. LOW VOLUME | 11. FILTERS | 12. INJECTION | 13. HARDWARE | INDEX

HUNTER® CONTROL VALVES

HUNTER® ICV INSTITUTIONAL COMMERCIAL VALVES

Part No.	Description	Case Qty.	Price
ICV-101G	1" Glass-filled Nylon, 220 PSI Globe Valve with Flow Control	12	
ICV-101G-FS	1" Glass-filled Nylon, 220 PSI Globe Valve with Flow Control & Filter Sentry™ Option	12	
ICV-151G	1-1/2" Glass-filled Nylon, 220 PSI Globe Valve with Flow Control	8	
ICV-151G-FS	1-1/2" Glass-filled Nylon, 220 PSI Globe Valve with Flow Control & Filter Sentry™ Option	8	
ICV-201G	2" Glass-filled Nylon, 220 PSI Globe Valve with Flow Control	8	
ICV-201G-FS	2" Glass-filled Nylon, 220 PSI Globe Valve with Flow Control & Filter Sentry™ Option	8	
ICV-301	3" Glass-filled Nylon, 220 PSI Globe Valve with Flow Control	4	
ICV-301-FS	3" Glass-filled Nylon, 220 PSI Globe Valve with Flow Control & Filter Sentry™ Option	4	



HUNTER® IBV BRASS VALVES

Part No.	Description	Case Qty.	Price
IBV-101G	1" Brass Globe Valve with Flow Control	4	
IBV-101G-FS	1" Brass Globe Valve with Flow Control, with Factory Installed Filter Sentry™ Diaphragm	4	
IBV-151G	1-1/2" Brass Globe Valve with Flow Control	2	
IBV-151G-FS	1-1/2" Brass Globe Valve with Flow Control, with Factory Installed Filter Sentry™ Diaphragm	2	
IBV-201G	2" Brass Globe Valve with Flow Control	2	
IBV-201G-FS	2" Brass Globe Valve with Flow Control, with Factory Installed Filter Sentry™ Diaphragm	2	
IBV-301G	3" Brass Globe Valve with Flow Control	1	
IBV-301G-FS	3" Brass Globe Valve with Flow Control, with Factory Installed Filter Sentry™ Diaphragm	1	

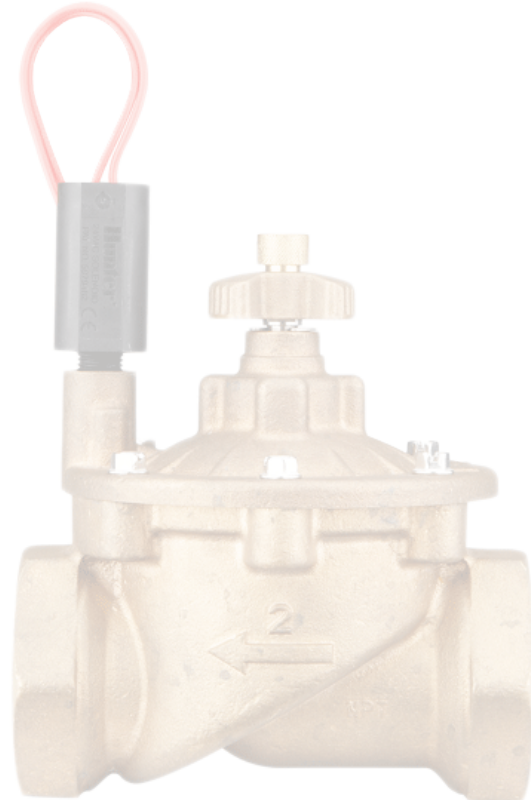
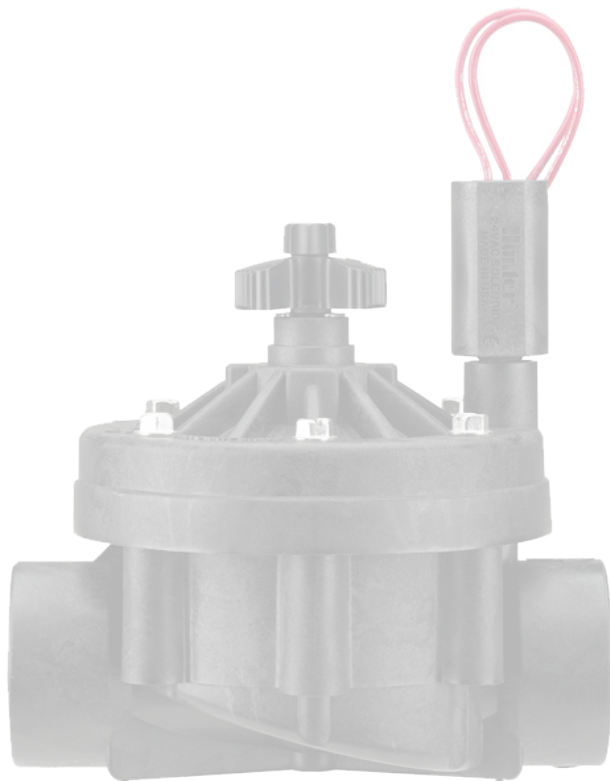
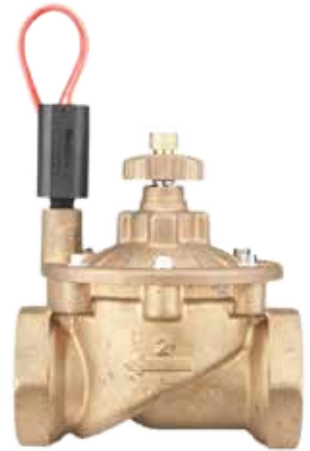

IRRITROL® CONTROL VALVES

IRRITROL® CONTROL VALVE APPLICATIONS & FEATURES

Primary Applications	100 Series	700 Series	205 Series	2500 Series
Residential			•	•
Light Commercial	•	•		•
Commercial	•	•		
Electric Operation	•	•	•	•
Angle Type	•		•	
Globe Type	•	•		•
Flow Control	•	•	•	•
Internal Bleed	•	•		•
External Bleed	•		•	•
Anti-Contamination Model Available	•			
PVC Body			•	•
Glass Reinforced Nylon Body	•	•		
Optional DC Latching Solenoid	•	•	•	•
Optional Recycled Water Kit *	•	•	•	•
Optional OmniReg™ Pressure Regulator	•	•		
Optional Waterproof Gauge	•	•		
Flow Ranges (GPM)	5 - 300	2 - 180	.25 - 30	.25 - 30
Operating Pressure Range (PSI)	10 - 200	10 - 150	10 - 150	10 - 150
Inlet / Outlet Options	1", 1-1/2", 2" 3" FIPT	3/4", 1", 1-1/2", 2" FIPT	1" FIPT or Slip	1" FIPT or Slip

* Includes purple solenoid and purple warning tag.

IRRITROL® 100 SERIES CENTURY GLOBE / ANGLE VALVE

Part No.	Description	Case Qty.	Price
100P1	1" Century Valve with Flow Control	24	
100P1.5	1 1/2" Century Valve with Flow Control	12	
100P2	2" Century Valve with Flow Control	4	
100P3	3" Century Valve with Flow Control	4	



IRRITROL® 700 SERIES ULTRA-FLOW GLOBE VALVE

Part No.	Description	Case Qty.	Price
700B-.75	3/4" Ultra-Flow Valve with Flow Control	12	
700-1	1" Ultra-Flow Valve with Flow Control	24	
700-1.5	1-1/2" Ultra-Flow Valve with Flow Control	12	
700-2	2" Ultra-Flow Valve with Flow Control	8	

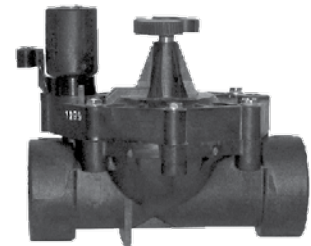

IRRITROL® REPLACEMENT SOLENOIDS

Part No.	Description	Case Qty.	Price
R811-24V	Replacement Solenoids	1	



INTRO | 1. ELECTRICAL | 2. PUMP ACC. | 3. HOSE, PE PIPE & ACC. | 4. IPS, PIP PIPE & ACC. | 5. SURFACE | 6. SPRINKLERS | 7. TRAVELER & WHEEL MOVE | 8. PIVOT | 9. TURF | 10. LOW VOLUME | 11. FILTERS | 12. INJECTION | 13. HARDWARE | INDEX

IRRITROL® CONTROL VALVES

IRRITROL® 205 SERIES RESIDENTIAL GLOBE VALVE

Part No.	Description	Case Qty.	Price
205S	1" Slip Residential Valve	20	
205SF	1" Slip Residential Valve with Flow Control	20	
205T	1" FIPT Residential Valve	20	
205TF	1" FIPT Residential Valve with Flow Control	20	



IRRITROL® 2500 SERIES RESIDENTIAL GLOBE VALVE

Part No.	Description	Case Qty.	Price
2500S	1" Slip Residential Valve	20	
2500SF	1" Slip Residential Valve with Flow Control	20	
2500T	1" FIPT Residential Valve	20	
2500TF	1" FIPT Residential Valve with Flow Control	20	



JOHN DEERE™ QUANTUM VALVES

JOHN DEERE™ ELECTRIC & HYDRAULIC VALVES (PLASTIC)

Part No.	Description	Case Qty.	Price
D100E	1" 24VAC Pressure Regulated Valve MPT	4	
D150E	1-1/2" 24VAC Pressure Regulated Valve MPT	4	
D150E3	1-1/2" 3-Way 24VAC Globe Valve MPT	4	
D150H	1-1/2" Hydraulic Pressure Regulated Valve MPT	4	
D200E	2" 24VAC Pressure Regulated Valve MPT	4	
D200E3	2" 3-Way 24VAC Globe Valve MPT	4	
D200H	2" Hydraulic Pressure Regulated Valve MPT	4	



CHAMPION® CONTROL VALVES

MANUAL ANGLE VALVE WITH CROSS HANDLE

Part No.	Description	Case Qty.	Price
200RS-075Y	3/4" Brass Manual Angle Valve	20	
200RS-100Y	1" Brass Manual Angle Valve	15	
200RS-125	1-1/4" Brass Manual Angle Valve	6	
200RS-150	1-1/2" Brass Manual Angle Valve	4	
200RS-200	2" Brass Manual Angle Valve	2	



TORO® VALVES

EZ-FLO PLUS SERIES VALVES - AC SOLENOIDS

Part No.	Description	Case Qty.	Price
EZF-29-03	3/4" Electric, NPT Anti-siphon	20	
EZF-29-04	1" Electric, NPT Anti-siphon	20	
EZF-20-04	1" Electric, Slip	20	
EZF-26-04	1" Electric, Female NPT	20	
EZF-21-04	1" Electric, Male x Male NPT	10	
EZF-25-04	1" Electric, Male x Barb NPT	10	
EZF-00-04	1" Electric, Slip without Flow Control	20	
EZF-06-04	1" Electric, Female NPT without Flow Control	20	
EZF-05-04	1" Electric, Male x Barb NPT without Flow Control	10	



EZ-FLO PLUS SERIES VALVES - DC SOLENOIDS

Part No.	Description	Case Qty.	Price
EZF-20-94	1" Electric, Slip, with DC Latching Solenoid	20	
EZF-26-94	1" Electric, Female, NPT with DC Latching Solenoid	20	
EZF-21-94	1" Electric, Male x Male NPT with DC Latching	10	
EZF-25-94	1" Electric, Male x Barb NPT with DC Latching	10	

Multiple inlet and outlet configurations as well as a jar-top design give this valve the flexibility and serviceability that can meet residential applications anywhere in the world.

Operating Specifications & Features:

- Female Globe: 5-1/8" H x 3" W x 4" L
- Male Globe: 5-1/8" H x 3" W x 5-1/2" L
- Anti-Siphon: 6" H x 3" W x 6-7/8" L
- Flow Range:
 - 3/4": 0.25 - 20 GPM
 - 1": 0.25 - 30 GPM
- Operating Pressure: 10-150 PSI
- Encapsulated Solenoid (102-7053) with captured hex plunger ring and O-ring (24 VAC):
 - (Inrush Current, 0.4 AMPS)
 - (Holding Current, 0.2 AMPS)
- Available with or without flow control

TPV SERIES VALVES - AC SOLENOIDS

Part No.	Description	Case Qty.	Price
TPV100	1" Female NPT, In-Line, w/o Flow Control	20	
TPVF100	1" Female NPT, In-Line, w/ Flow Control	20	
TPV100MM	1" Male Thread x Male Thread, In-Line, w/o Flow Control	20	
TPVF100MM	1" Male Thread x Male Thread, In-Line, w/ Flow Control	20	
TPV100S	1" Slip x Slip, In-Line, w/o Flow Control	20	
TPVF100S	1" Slip x Slip, In-Line, w/ Flow Control	20	
TPV100MB	1" Male Thread x Barb, In-Line, w/o Flow Control	20	
TPVF100MB	1" Male Thread x Barb, In-Line, w/ Flow Control	20	



TPV SERIES VALVES - DC SOLENOIDS

Part No.	Description	Case Qty.	Price
TPVF100DC	1" Female NPT, In-Line, w/ Flow Control DCLS-P	20	
TPVF100MMDC	1" Male Thread x Male Thread, In-Line, w/ Flow Control, DCLS-P	20	
TPVF100SDC	1" Slip x Slip, In-Line, w/ Flow Control, DCLS-P	20	
TPVF100MBDC	1" Male Thread x Barb, In-Line, w/ Flow Control, DCLS-P	20	

The search for a full-featured, economically priced residential and commercial valve is over thanks to Toro's newest 1" valve offering the TPV Series. These full-featured, rugged, debris-resistant valves feature flow ranges from 0.1 to 40 GPM, making them ideal for everything from drip to high-flow residential and commercial applications. Choose from a variety of inlet and outlet selections to ensure that all site specific requirements are met. The patented DBS Technology™ (Debris Bypass System) ensures valve functionality in nearly all dirty water applications. Add a 5-year warranty and rest assured that the TPV Series will become your workhorse valve for all professional installations.

Operating Specifications & Features:

- 5-1/8" H, 2-3/4" W, 5" L
- Operating Specifications
- Flow Range: 0.1 to 40 GPM
- Operating Pressure: Electric – 10 to 175 psi
- Burst pressure safety rating: 1000 psi
- Solenoid: 24 VAC (50/60 Hz) Standard (102-7053)
 - (Inrush: 0.4 amps) (Holding: 0.2 amps)
- Tough Double-Beaded, Chloramine and Ozone-Resistant Santoprene® Diaphragm ensures a consistent, leak-proof seal all the way up to 175 psi.
- Patented DBS (Debris Bypass System) Technology™
- Multiple Body Styles
- Wide Range of Flows and Pressure
- One valve for all site specific needs.
- Robust Solenoid Design ensures reliable opening and closing.

INTRODUCTION
 1. ELECTRICAL
 2. PUMP ACC.
 3. HOSE, PE PIPE & ACC.
 4. IPS, PIP PIPE & ACC.
 5. SURFACE
 6. SPRINKLERS
 7. TRAVELER & WHEEL MOVE
 8. PIVOT
 9. TURF
 10. LOW VOLUME
 11. FILTERS
 12. INJECTION
 13. HARDWARE
 INDEX

TORO® VALVES

254 / 264 SERIES VALVES - AC SOLENOIDS

Part No.	Description	Case Qty.	Price
264-06-03	3/4" Male Thread x Male Thread w/o Flow Control	20	
254-06-04	1" Male Thread x Male Thread w/ Flow Control	20	
264-06-04	1" Male Thread x Male Thread w/o Flow Control	20	
254-16-04	1" Male Thread x Barb w/ Flow Control	20	
264-16-04	1" Male Thread x Barb w/o Flow Control	20	



Operating Specifications & Features:

- 3/4": 3" H x 4" W
- 1": 6" H x 4-1/2" W
- 1": 4-1/2" H x 4-1/2" W
- Flow Range: 0.25 to 30 GPM
- Operating Pressure: 10 to 150 PSI
- Burst pressure safety rating: 750 PSI
- Inrush:
 - 3/4" = 0.25 AMPS
 - 1" = 0.30 AMPS
- Construction: ABS, Glass-Filled Nylon
- Activation: Electric

These durable valves are designed for contractors who prefer male inlets and male or barbed outlets and need a valve that can withstand the pressures of large residential and light commercial applications.

P-220 SERIES VALVES

Part No.	Description	Case Qty.	Price
P220-26-04	1" In-line, Angle	24	
P220-26-06	1-1/2" In-line, Angle	12	
P220-26-08	2" In-line, Angle	4	
P220-26-00	3" In-line, Angle	4	
P220-26-94	1" In-line, Angle - with Pre-Installed Latching Solenoids	24	
P220-26-96	1-1/2" In-line, Angle - with Pre-Installed Latching Solenoids	12	
P220-26-98	2" In-line, Angle - with Pre-Installed Latching Solenoids	4	
P220-26-90	3" In-line, Angle - with Pre-Installed Latching Solenoids	4	



P-220 SERIES VALVES - PRESSURE REGULATED WITH EZ REG®

Part No.	Description	Case Qty.	Price
P220-27-04	1" In-line, Angle	24	
P220-27-06	1-1/2" In-line, Angle	12	
P220-27-08	2" In-line, Angle	4	
P220-27-00	3" In-line, Angle	4	
P220-27-94	1" In-line, Angle - with Pre-Installed Latching Solenoids	24	
P220-27-96	1-1/2" In-line, Angle - with Pre-Installed Latching Solenoids	12	
P220-27-98	2" In-line, Angle - with Pre-Installed Latching Solenoids	4	
P220-27-90	3" In-line, Angle - with Pre-Installed Latching Solenoids	4	

These heavy-duty glass filled nylon valves are specially designed for commercial applications with pressures up to 220 psi (15.2 BAR), but also have the ability to pressure regulate the flow through the valve anywhere from 5–100 psi (.3 - 6.9 BAR)

Operating Specifications & Features:

- 1": 6-3/4" H x 3-5/8" W
- 1-1/2": 7 1/4" H x 3-5/8" W
- 2": 9-1/2" H x 6-1/8" W
- 3": 10 3/4" H x 6-1/8" W
- Flow Range: 5.0 to 300 GPM
- Operating Pressure: 10 to 220 PSI
- Burst pressure safety rating: 750 PSI
- Inrush: 0.40 AMPS, Spike Guard 0.12 AMPS
- Construction: Glass-Filled Nylon
- Activation: Electric

RAIN BIRD® CONTROLLERS

RAIN BIRD® CONTROLLERS APPLICATIONS AND FEATURES

Primary Applications	ESP-ME Modular	ESP-LX Modular	ESP-MC	TBOS™
Residential	•	•	•	•
Light Commercial	•	•	•	•
Commercial / Industrial			•	•
Indoor	•	•	•	
Outdoor	•	•	•	
Solid State				•
Hybrid	•	•	•	
Battery Operated				•
Master Valve / Pump Start	•	•	•	
Rain Delay		•	•	
Water Budgeting	•	•		
Programmable Delay Between Stations	•	•	•	
Diagnostic Circuit Breaker	•	•		
Vandal / Tamper Resistant				•
230VAC Option	•	•	•	
Optional RSD Rain Sensor	•	•	•	•
Optional RBOS Rain Shut-Off Device				•
Optional Stainless Steel Pedestal			•	
Optional Painted Pedestal			•	
Stations	4, 7, 10, 13, 16, 19, 22	8, 12, 16, 20, 24, 28, 32	8, 12, 16, 24, 28, 32, 36, 40	6
Programs	3	4	4	3

ESP-RZX SERIES CONTROLLERS (INDOOR / OUTDOOR MOUNT)

Part No.	Description	Price
RZX4i-120V	Indoor 4 Station Controller - 120V	
RZX6i-120V	Indoor 6 Station Controller - 120V	
RZX8i-120V	Indoor 8 Station Controller - 120V	
RZX4i-230V	Indoor 4 Station Controller - 230V	
RZX6i-230V	Indoor 6 Station Controller - 230V	
RZX8i-230V	Indoor 8 Station Controller - 230V	
RZX4-120V	Outdoor 4 Station Controller - 120V	
RZX6-120V	Outdoor 6 Station Controller - 120V	
RZX8-120V	Outdoor 8 Station Controller - 120V	
RZX4-230V	Outdoor 4 Station Controller - 230V	
RZX6-230V	Outdoor 6 Station Controller - 230V	
RZX8-230V	Outdoor 8 Station Controller - 230V	



ESP-ME MODULAR CONTROLLER (INDOOR / OUTDOOR MOUNT)

Building on its predecessor—the ESP Modular—the enhanced Rain Bird® ESP-ME offers easy programming, a higher station count and new features so easy to use, you'll actually use them.

With 4 to 22 station capability, vibrant colors, easy-to-read text, oversized LCD display and Extra Simple Programming, tailoring a watering schedule for your unique landscape is foolproof.

Part No.	Description	Price
ESP4MEI	4 Station Base Unit (Indoor Mount), 120V/60Hz	
ESP4ME	4 Station Base Unit (Outdoor Mount), 120V/60Hz	



INTRO
 1. ELECTRICAL
 2. PUMP ACC.
 3. HOSE, PE PIPE & ACC.
 4. IPS, PIP PIPE & ACC.
 5. SURFACE
 6. SPRINKLERS
 7. TRAVELER & WHEEL MOVE
 8. PIVOT
 9. TURF
 10. LOW VOLUME
 11. FILTERS
 12. INJECTION
 13. HARDWARE
 INDEX

RAIN BIRD® CONTROLLERS

ESP-SMT MODULAR CONTROLLER (INDOOR / OUTDOOR MOUNT)

Part No.	Description	Price
ESP4SMTE	4 Station Indoor Smart Timer	
ESP4SMTEi	4 Station Outdoor Smart Timer	

Modular Indoor Smart Controller plus weather sensor, automatically adjusts watering times for each zone based on temperature, effective rainfall and plant/soil type to reduce water use by 30-70%. Expands up to 13 stations with plug-in module. (Modules sold separately)



ESP-M MODULAR EXPANSION MODULE

Part No.	Description	Price
ESPSM3	3 station module (Compatible with all ESP Modular models)	
ESPSM6	6 station indoor module (Compatible with ESP4ME only)	



ESP-LXME CONTROLLER (8 - 48 STATION COMMERCIAL CONTROLLER)

Part No.	Description	Price
ESP8LXME	8 Station, 120 VAC - Base Models	
ESP12LXME	12 Station, 120 VAC - Base Models	
ESP8LXMEF	8 Station, 120 VAC - with Flow Sensing	
ESP12LXMEF	12 Station, 120 VAC - with Flow Sensing	
FSMLXME	Flow Smart Module	
ESPLXMSM4	4 Station Module	
ESPLXMSM8	8 Station Module	
ESPLXMSM12	12 Station Module	



LANDSCAPE IRRIGATION AND MAINTENANCE REMOTE (LIMR)

Part No.	Description	Price
LIMR-KIT	Compatible with ESP-Modular, ESP-SMT, ESP-LX, ESP-LX+, ESP-LXME, ESP-LXMEF, ESP-LXD, ESP-LXDF, STPi, and STP Plus Controllers	

Maintaining Rain Bird system operation and head alignment is easier and faster than ever because you no longer have to walk to the clock to turn zones on or off. A single crew member can activate zones, blow out systems and perform other winterization or maintenance tasks.

- Operating Range – Up to 1.5 miles line of sight.
- Two-way communication using FCC certified 900MHz radios.
- UL Recognized product
- Custom names can be assigned to 20 different receivers for easy identification.
- Each handheld remote can control up to 128 different receivers simultaneously.



ESP-MC CONTROLLER (OUTDOOR FOR COMMERCIAL USE)

Part No.	Description	Price
ESP12MC	12 Station 4 Program Metal Wall Mount Cabinet	
ESP24MC	24 Station 4 Program Metal Wall Mount Cabinet	
ESP40MC	40 Station 4 Program Metal Wall Mount Cabinet	
ESP12MCSS	12 Station 4 Program in SS Pedestal	
ESP24MCSS	24 Station 4 Program in SS Pedestal	

Note: 5 Day lead time for ESPMCSS controllers



RAIN BIRD® CONTROLLERS

RAIN BIRD® ET MANAGER™ CONTROLLER

New from Rain Bird, the ET Manager is flexible and works with virtually any existing irrigation controller. Nearly any irrigation configuration from the smallest residential yard to the largest commercial application can benefit from ET Manager. Dramatic water savings mean that ET Manager is the smart choice for nearly any non-central control application: state agencies, water districts, universities, schools, parks, commercial buildings, planned communities, homeowner associations, apartment buildings, and more.

Although over-watering has always been something homeowners, public water agencies, property managers and landscapers tried to avoid, increasing water scarcity has brought this problem into the spotlight. No matter how efficient an irrigation controller's watering schedule is, it must take into account constantly changing weather conditions, specifically evapotranspiration (ET) and rainfall.

ET is the amount of water lost from the soil through evaporation plus the plant's water loss (known as transpiration), both of which are dramatically affected by weather conditions. Rain Bird ET Manager™ uses current weather information and ET to water your landscape only when it needs it. Since precise landscape water management is key to avoiding over-watering, the ET Manager can be an effective tool.

This simple, powerful irrigation management solution works with virtually any controller, converting a conventional irrigation system into a weather-smart one that adjusts itself according to accurate real-time weather data. The ET Manager helps to maintain the optimum moisture balance in your soil. As the weather changes, your ET Manager receives updates automatically every hour and only allows your controller to water when needed. The result: significant water savings, deeper root systems, and a healthier landscape. Whether you are a water agency, contractor, specifier, or homeowner, the ET Manager is the smart choice. ET Manager technology is based on the Irrigation Association endorsed, ASCE-standardized ET equation, and includes data from all required climatic variables (solar radiation, temperature, wind, and humidity). An optional onsite rain gauge can further localize the weather data accuracy. With the ET Manager, your irrigation system will always be in tune with the weather.

Part No.	Description	Price
ETMi	ET Manager Control Device, Indoor Model Only	

OPTIONAL ACCESSORIES

ETMANT	ETMi Remote Antenna Kit*	
ETMRG	Tipping Rain Gauge	
ETMWRSS	Weather Reach Server Software	
ETMPS	ET Manager Programming Software	
ETMIOE	ETMi Outdoor Enclosure	
ETMITRAN	120VAC Plug-in Transformer-635640	

*ET Manager has a built in antenna. Locations with a weak service signal may require an external antenna.

Note: Not all areas have service coverage for the ET Manager. Please call us or check Rain Bird's website to see if your location has service coverage.



RAIN BIRD® BATTERY POWERED CONTROLLERS

TBOS-II™ SERIES BATTERY POWERED CONTROLLER

Part No.	Description	Price
TBOS2FTUS	Field Transmitter	
TBOS2CM1	1 Station Module	
TBOS2CM2	2 Station Module	
TBOS2CM4	4 Station Module	
TBOS2CM6	6 Station Module	
TBOSPSOL	Potted Latching Solenoid	



INTRO
 1. ELECTRICAL
 2. PUMP ACC.
 3. HOSE, PE PIPE & ACC.
 4. IPS, PIP PIPE & ACC.
 5. SURFACE
 6. SPRINKLERS
 7. TRAVELER & WHEEL MOVE
 8. PIVOT
 9. TURF
 10. LOW VOLUME
 11. FILTERS
 12. INJECTION
 13. HARDWARE
 INDEX

HUNTER® CONTROLLERS

HUNTER® CONTROLLERS APPLICATIONS AND FEATURES

Primary Applications	X-CORE Plastic Cabinet	PRO-C Plastic Cabinet	I-CORE Plastic Cabinet	I-CORE Metal Cabinet	I-CORE Stainless Steel Cabinet	I-CORE Plastic Pedestal	ACC Metal Cabinet	ACC Plastic Pedestal
Residential	•	•	•					
Light Commercial		•	•	•	•	•	•	•
Commercial / Institutional			•	•	•	•	•	•
Indoor	•	•	•	•	•		•	•
Outdoor	•	•	•	•	•	•	•	•
Master Valve / Pump Start Circuit	•	•	•	•	•	•	2	2
Seasonal Adjust / Water Budget	•	•	•	•	•	•	•	•
Programmable Rain Delay	•	•	•	•	•	•	•	•
Rain Sensor Bypass	•	•	•	•	•	•	•	•
True Odd / Even Watering	•	•	•	•	•	•	•	•
Interval Watering	•	•	•	•	•	•	•	•
Cycle and Soak			•	•	•	•	•	•
Programmable Delay Between Stations	•	•	•	•	•	•	•	•
Test Program	•	•	•	•	•	•	•	•
Non-Volatile Memory	•	•	•	•	•	•	•	•
Real Time Flow Sensing							•	•
Battery Operated								
Remote Control Ready		•	•	•	•	•	•	•
Upgradable to Central Control		•	•	•	•	•	•	•
Hunter Quick Check™*	•	•	•	•	•	•		
Optional Pedestal Mounting			•	•	•	•	•	
Number of Stations Available	2, 4, 6, 8	3, 9	8	8	8	8	12	12
Number of Programs	3	3	4	4	4	4	6	6

* Helps troubleshoot field wiring issues.

Note: While all of these controllers are not displayed in our catalog, please contact us for information and pricing if you see one that might better address your system requirements.

X-CORE, RESIDENTIAL CONTROLLERS

Part No.	Description	Price
XC200i	2 Station Controller Indoor Mount Only, 120 VAC or 240 VAC	
XC400	4 Station Controller Indoor / Outdoor Mount, 120 VAC or 240 VAC	
XC600	6 Station Controller Indoor / Outdoor Mount, 120 VAC or 240 VAC	
XC800	8 Station Controller Indoor / Outdoor Mount, 120 VAC or 240 VAC	



PRO-C, RESIDENTIAL / LIGHT COMMERCIAL CONTROLLERS

Part No.	Description	Price
PC-300i	3 Station Controller Indoor Mount, Expandable to 15 Stations	
PC-300	3 Station Controller Outdoor Mount, Expandable to 15 Stations	
PCM-300	3 Station Module for Pro-C Controller	
PCM-900	9 Station Module for Pro-C Controller	



HUNTER® CONTROLLERS

I-CORE COMMERCIAL CONTROLLER

Part No.	Description	Price
IC-600-PL	6 Station Controller, Indoor/Outdoor, Plastic Cabinet	
IC-600-M	6 Station Controller, Indoor/Outdoor, Metal Cabinet	
IC-600-SS	6 Station Controller, Indoor/Outdoor, Stainless Steel Cabinet	
ICM-600	6 Station Plug-in Module Used to Increase Station Count by 6	



PRO-C CONTROLLER (CONVENTIONAL)

Part No.	Description	Price
PCC-600I	6 Station Controller, Indoor Model, Plug-in Transformer	
PCC-600	6 Station Controller, Outdoor Model, Plug-in Transformer	
PCC-900I	9 Station Controller, Indoor Model, Plug-in Transformer	
PCC-900	9 Station Controller, Outdoor Model, Plug-in Transformer	
PCC-1200I	12 Station Controller, Indoor Model, Plug-in Transformer	
PCC-1200	12 Station Controller, Outdoor Model, Plug-in Transformer	
PCC-1500I	15 Station Controller, Indoor Model, Plug-in Transformer	
PCC-1500	15 Station Controller, Outdoor Model, Plug-in Transformer	



HUNTER® BATTERY POWERED CONTROLLERS

NODE

Part No.	Description	Price
NODE-100	Single station controller (DC latching solenoid included)	
NODE-200	2 Station controller (DC latching solenoid ordered separately)	
NODE-400	4 Station controller (DC latching solenoid ordered separately)	
NODE-600	6 station controller (DC latching solenoid ordered separately)	



HUNTER® CONTROLLER

ROAM REMOTE CONTROL SYSTEM

Part No.	Description	Price
ROAM-KIT	Transmitter, receiver (SmartPort® wiring harness, and 4 AAA batteries included)	

The Roam Remote Allows for Controller Operation Up To 1,000 Feet.



TORO® CONTROLLERS

Looking for a rugged waterproof controller ideal for remote or isolated installations? Toro's DDCWP Series controller provides all that and more. Using the new potted DC latching solenoid popular on Toro EZFlo® Plus, TPV, P-220 and 220 Brass Series valves, the DDCWP is battery-operated using two 9V batteries. Toro's exclusive digital dial technology provides the simplicity of a mechanical dial without any moving parts. The digital dial guides users through simple programming functions without the potential for mechanical failure common to traditional dials. Available in 2-, 4-, 6-, and 8-station models, the DDCWP is a controller for those who demand a step above the rest.

DDCWP SERIES CONTROLLERS

Part No.	Description	Price
DDCWP-2-9V	2 Station Module	
DDCWP-4-9V	4 Station Module	
DDCWP-6-9V	6 Station Module	
DDCWP-8-9V	8 Station Module	



TMC-212 SERIES CONTROLLERS

Part No.	Description	Price
TMC-212-ID	4 Station, Indoor	
TMC-212-OD	4 Station, Outdoor	



TMC-212 SERIES MODULES

Part No.	Description	Price
TSM-02	2 Station Expansion Module	



SUPERIOR CONTROLLER

STERLING SOLID STATE CONTROLLER

Part No.	Description	Price
STERLING-4H	4 Station Outdoor Controller w/ Heavy-Duty Transformer	
STERLING-8H	8 Station Outdoor Controller w/ Heavy-Duty Transformer	
STERLING-12H	12 Station Outdoor Controller w/ Heavy-Duty Transformer	
STERLING-18H	18 Station Outdoor Controller w/ Heavy-Duty Transformer	
STERLING-24H	24 Station Outdoor Controller w/ Heavy-Duty Transformer	
STERLING-30H	30 Station Outdoor Controller w/ Heavy-Duty Transformer	
STERLING-36H	36 Station Outdoor Controller w/ Heavy-Duty Transformer	



IRRITROL® CONTROLLERS

IRRITROL® CONTROLLERS APPLICATIONS AND FEATURES

Primary Applications	PC Control	Rain Dial	Smart Dial	Total Control	KWIK DIAL	JR MAX	MC-E	IBOC-PLUS	IBOC300-9V
Residential	•	•	•	•	•	•	•		•
Light Commercial		•	•	•			•	•	•
Commercial			•	•			•	•	•
Hybrid		•	•	•	•		•	•	
Solid State	•					•			•
Indoor	•	•	•	•	•	•			
Outdoor		•	•	•	•	•	•	•	•
Water Budgeting	•	•	•	•	•	•	•	•	
Electronic Circuit Breaker	•	•	•	•	•	•	•	•	
Automatic, ET Based			•						
Remote Ready	•	•			•		•		•
Battery Powered								•	•
Solar Power Option								•	
Optional Pump Start Relay	•	•	•	•	•	•	•		
Optional Wireless Rain Sensor	•	•	•	•	•	•	•		
Optional Wireless Rain / Freeze Sensor	•	•	•	•	•	•	•		
Optional Wired Rain Sensor	•	•	•	•	•	•	•	•	
Optional External Antenna Kit			•						
Optional Pedestal Mount							•	•	
Number of Stations Available	12, 24, 36, 48	6, 9, 12	6, 9, 12, 24	6, 9, 12, 15, 24	4, 6, 9, 12,	4, 6, 8	4, 6, 8, 12, 18, 24, 30, 36, 42, 48	4, 8, 12	1
Programs	N/A	3	2	4	3	3	8	3	1

Note: While all of these controllers are not displayed in our catalog, please contact us for information and pricing if you see one that might better address your system requirements.

MC-E® SERIES CONTROLLER

Part No.	Description	Price
MC-4E	4 Station Outdoor Controller	
MC-6E	6 Station Outdoor Controller	
MC-8E	8 Station Outdoor Controller	
MC-12E	12 Station Outdoor Controller	
MC-18E	18 Station Outdoor Controller	
MC-24E	24 Station Outdoor Controller	
MC-30E	30 Station Outdoor Controller	
MC-36E	36 Station Outdoor Controller	
MC-42E	42 Station Outdoor Controller	
MC-48E	48 Station Outdoor Controller	



Note: Only MC+B Series controllers will be distributed until existing inventory is depleted.

RAIN DIAL CONTROLLER WITH KEY LOCK & PLASTIC CASE

Part No.	Description	Price
RD600-INT-R	6 Station Indoor Controller	
RD900-INT-R	9 Station Indoor Controller	
RD1200-INT-R	12 Station Indoor Controller	
RD600-EXT-R	6 Station Outdoor Controller	
RD900-EXT-R	9 Station Outdoor Controller	
RD1200-EXT-R	12 Station Outdoor Controller	



INTRO
 1. ELECTRICAL
 2. PUMP ACC.
 3. HOSE, PE PIPE & ACC.
 4. IPS, PIP PIPE & ACC.
 5. SURFACE
 6. SPRINKLERS
 7. TRAVELER & WHEEL MOVE
 8. PIVOT
 9. TURF
 10. LOW VOLUME
 11. FILTERS
 12. INJECTION
 13. HARDWARE
 INDEX

HUNTER® PUMP START RELAY

HUNTER® PSR, PUMP START RELAY

Part No.	Description	Price
PSR-22	2 Pole / 1 Throw PSR for 120VAC Pumps up to 2 HP or 240VAC pumps up to 3.5 HP	
PSR-52	2 Pole / 1 Throw PSR for 120VAC Pumps up to 5 HP or 240VAC pumps up to 7.5 HP	



RAIN BIRD® PUMP START RELAY

RAIN BIRD® PSR, UNIVERSAL PUMP START RELAY

Part No.	Description	Price
RBSR24WG1	PSR Universal Pump Start Relay 100V	
RBSR24WG2	PSR Universal Pump Start Relay 220V	



WEATHER SENSORS

RAIN BIRD® WR2 WIRELESS RAIN OR RAIN/FREEZE SENSOR

Part No.	Description	Price
WR2-RC	Rain Combo	
WR2-RFC	Rain / Freeze Combo	
WR2RC	Rain Sensor Only	
WR2RFC	Rain / Freeze Sensor Only	
WR2-RFI	Rain / Freeze Controller Only	
651009S	WRS Battery	
637810S	WR2 Disk Assembly	



RAIN BIRD® RSD SERIES RAIN SENSOR

Part No.	Description	Price
RSD-BEX	with Bracket, Extension Wire	
RSD-CEX	with Threaded Adapter, Extension Wire	



HUNTER® MINI-CLI-K® RAIN SENSORS

Part No.	Description	Price
MINI-CLI-K	Adjusts for Rainfall of 1/8" to 1" includes 25' Wire	
MINI-CLI-K-HV	Adjusts for Rainfall of 1/8" to 1"	



WEATHER SENSORS

HUNTER® RAIN-CLIK™ RAIN SENSORS

Part No.	Description	Price
WRF-CLIK	Wireless Rain/Freeze Sensor	

HUNTER® WIRELESS RAIN-CLIK™ RAIN SENSORS

Part No.	Description	Price
WR-CLIK	Wireless Rain Sensor with Quick Response™ System	

HUNTER® FREEZE-CLIK® FREEZE SENSORS

Part No.	Description	Price
FREEZE-CLIK	3° C (37°F) Setpoint, 25' Wire, Screws, 24VAC, 6AMP	
FREEZE-CLIK-REV	Reverse Switching, 3° C (37°F) Setpoint, 25' Wire, Screws, 24VAC, 6AMP	

HUNTER® WIND-CLIK® WIND SENSOR

Part No.	Description	Price
WIND-CLIK	Adjustable Wind Control 12-35 MPH Shut Down, 24VAC, 5 AMP	

TORO® SENSORS

Part No.	Description	Price
TRS	Wired Rain Sensor	
TWRS	Wireless Rain Sensor	
TWRFS	Wireless Rain & Freeze Sensor	
PSS-KIT	Precision Wireless Soil Sensor	



WATER PRESSURE REDUCING VALVES

NR3 PRESSURE REDUCING VALVE

Part No.	Description	Price
NR3SC-1/2	1/2" 15-75 PSI Factory Set @ 50 PSI	
NR3SC-3/4	3/4" 15-75 PSI Factory Set @ 50 PSI	
NR3SC-1	1" 15-75 PSI Factory Set @ 50 PSI	
NR3SC-1-1/4	1-1/4" 15-75 PSI Factory Set @ 50 PSI	
NR3SC-1-1/2	1-1/2" 25-75 PSI Factory Set @ 50 PSI	
NR3SC-2	2" 25-75 PSI Factory Set @ 50 PSI	

Larger Sizes Available



INTRO
1. ELECTRICAL
2. PUMP ACC.
3. HOSE, PE PIPE & ACC.
4. IPS, PIP PIPE & ACC.
5. SURFACE
6. SPRINKLERS
7. TRAVELER & WHEEL MOVE
8. PIVOT
9. TURF
10. LOW VOLUME
11. FILTERS
12. INJECTION
13. HARDWARE
INDEX

HOSE THREAD BACKFLOW PREVENTION

HOSE THREAD VACUUM BREAKER

Part No.	Description	Price
DG41	3/4" Plastic Hose Thread Vacuum Breaker	
646AS4	3/4" Brass Hose Thread Vacuum Breaker	



FEBCO® BACKFLOW PREVENTION - LEAD FREE

850 SERIES DOUBLE CHECK ASSEMBLY - LEAD FREE

Part No.	Description	Price
0683038	1/2" Double Check Assembly	
0683039	3/4" Double Check Assembly	
0683040	1" Double Check Assembly	
0683041	1-1/4" Double Check Assembly	
0683042	1-1/2" Double Check Assembly	
0683043	2" Double Check Assembly	



860 SERIES REDUCED PRESSURE ASSEMBLY - LEAD FREE

Part No.	Description	Price
0683000	1/2" Reduced Pressure Assembly	
0683001	3/4" Reduced Pressure Assembly	
0683002	1" Reduced Pressure Assembly	
0683003	1-1/4" Reduced Pressure Assembly	
0683004	1-1/2" Reduced Pressure Assembly	
0683005	2" Reduced Pressure Assembly	



CHAMPION® BACKFLOW PREVENTION

MANUAL ANTI-SIPHON VALVE

Part No.	Description	Price
466P-075Y	3/4" Manual Anti-Siphon Valve Less Union	
466P-100Y	1" Manual Anti-Siphon Valve Less Union	



ZURN-WILKINS BACKFLOW PREVENTION

DUAL CHECK ASSEMBLY - LEAD FREE

Part No.	Description	Price
34UFX34F-700XL	3/4" Dual Check Assembly	
1UFX1F-700XL	1" Dual Check Assembly	



ATMOSPHERIC VACUUM BREAKER - LEAD FREE

Part No.	Description	Price
35-3/4XL	3/4" Atmospheric Vacuum Breaker	
35-1XL	1" Atmospheric Vacuum Breaker	



950 SERIES DOUBLE CHECK ASSEMBLY - LEAD FREE

Part No.	Description	Price
3/4-950XLT2	3/4" Double Check Assembly	
1-950XLT2	1" Double Check Assembly	
1-1/2-950XLT2	1-1/2" Double Check Assembly	
2-950XLT2	2" Double Check Assembly	



SXL BRONZE WYE STRAINER - LEAD FREE

Part No.	Description	Price
SXL-75	3/4" Bronze Wye Strainer 20 Mesh	
SXL-1	1" Bronze Wye Strainer 20 Mesh	
SXL-15	1-1/2" Bronze Wye Strainer 20 Mesh	
SXL-20	2" Bronze Wye Strainer 20 Mesh	



720A SERIES PRESSURE VACUUM BREAKER - LEAD FREE

Part No.	Description	Price
3/4-420XL	3/4" Pressure Vacuum Breaker	
1-420XL	1" Pressure Vacuum Breaker	



975XL SERIES REDUCED PRESSURE ZONE ASSEMBLY - LEAD FREE

Part No.	Description	Price
3/4-975XL2	3/4" Reduced Pressure Zone Assembly	
1-975XL2	1" Reduced Pressure Zone Assembly	
1-1/2-975XL2	1-1/2" Reduced Pressure Zone Assembly	
2-975XL2	2" Reduced Pressure Zone Assembly	

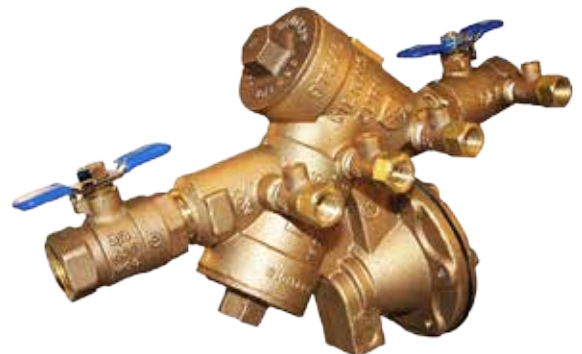

INTRO
1. ELECTRICAL
2. PUMP ACC.
3. HOSE, PE PIPE & ACC.
4. IPS, PIP PIPE & ACC.
5. SURFACE
6. SPRINKLERS
7. TRAVELER & WHEEL MOVE
8. PIVOT
9. TURN
10. LOW VOLUME
11. FILTERS
12. INJECTION
13. HARDWARE
INDEX

ARMOR® VALVE BOXES

10" ROUND VALVE BOX (9" DIA. X 10" HIGH)

Part No.	Description	Price
181104	Assembly - Black Box, Green Lid	
181014	Box Only - Black with 2 Mouse Holes	
181015	Lid Only - Green Control Valve	



12" STANDARD VALVE BOX (10" X 16" X 12" HIGH)

Part No.	Description	Price
170106	Assembly - Black Box, Green Lid w/ Snap Lock	
170101	Box Only - Black with Closed Mouse Holes	
173134	Lid Only - Green Control Valve w/ Snap Lock	
170102	3" Black Extension Only	
170103	6" Black Extension Only	



JUMBO VALVE BOX (13" X 20" X 12" HIGH)

Part No.	Description	Price
190106	Assembly - Black Box, Green Lid w/ Snap Lock	
190101	Box Only - Black with Closed Mouse Holes	
192101	Lid Only - Green Control Valve w/ Snap Lock	
190110	6" Black Extension Only	
144022	Snap Lock Unlocking Tool	



EXTRA LARGE UTILITY VALVE BOX (17" X 30" X 18" HIGH)

Part No.	Description	Price
195103	Assembly - Black Box, Green Lid	
195040	8" Black Extension Only	



DALLAS SPECIALTY & MFG. CO. VALVE BOXES

6" ROUND VALVE BOX (6-1/4" DIA. X 9" HIGH)

Part No.	Description	Price
DS109	Assembly	
DS109B	Box Only	
DS109L	Lid Only	



10" VALVE BOX (9-1/2" X 15" X 10" HIGH)

Part No.	Description	Price
DS1000I	Assembly	
DS1000B	Box Only	
DS1000IL	Lid Only	



NDS VALVE BOXES

6" ROUND VALVE BOX

Part No.	Description	Price
107BC	6" Round Valve Box, Complete	

10" ROUND VALVE BOX

Part No.	Description	Price
111BC	10" Round Valve Box, Complete	

STANDARD VALVE BOX (14" X 19")

Part No.	Description	Price
113BC	14" x 19" Standard Valve Box, Complete	
113-6	6" Extension for Standard Valve Box	

JUMBO VALVE BOX (13" X 20")

Part No.	Description	Price
117BC	13" x 20" Jumbo Valve Box, Complete	
117-6	6" Extension for Jumbo Valve Box	

VALVE BOX (17" X 30")

Part No.	Description	Price
124BCB	17" x 30" x 15", Overlapping Bolt-Down Cover - ICV	
124BCDB	17" x 30" x 15", Drop-in Bolt-Down Cover - ICV	
124B	17" x 30" x 15", Box	

RAIN BIRD® VALVE BOXES

6" ROUND VALVE BOX (6.1" DIA. X 9" HIGH)

Part No.	Description	Price
VB-6RND	Assembly - Body & Green Lid	

10" ROUND VALVE BOX (10.25" DIA. X 10" HIGH)

Part No.	Description	Price
VB-10RND	Assembly - Body & Green Lid	

STANDARD VALVE BOX (12.8" X 16.6" X 12" HIGH)

Part No.	Description	Price
VB-STD	Assembly - Body & Green Lid	

JUMBO VALVE BOX (26.3" X 19.8" X 12.1" HIGH)

Part No.	Description	Price
VB-JMB	Assembly - Body & Green Lid	



DEKORRA® ROCK COVERS

106 ROCK (19" LENGTH X 14" WIDTH X 12" HEIGHT)

Part No.	Description	Price
106-FS	Field Stone Color	
106-RB	River Bed Color	



102 ROCK (27" LENGTH X 21" WIDTH X 25" HEIGHT)

Part No.	Description	Price
102-FS	Field Stone Color	
102-RB	River Bed Color	



103 ROCK (56" LENGTH X 42" WIDTH X 30" HEIGHT)

Part No.	Description	Price
103-FS	Field Stone Color	
103-RB	River Bed Color	



104 ROCK (60" LENGTH X 48" WIDTH X 41" HEIGHT)

Part No.	Description	Price
104-FS	Field Stone Color	
104-RB	River Bed Color	



DEKORRA® ROCK COVER ACCESSORIES

INSULATED POUCHES FOR ROCKS

Part No.	Description	Price
602-GN	24"L x 24"H Insulated Pouch works with 101 & 102 Rocks	
603-GN	48"L x 24"H Insulated Pouch works with 103 & 104 Rocks	
604-GN	48"L x 24"H Insulated Ring or Pouch works with 103 & 104 Rocks	



THE GUARDIAN W51 HEATING ELEMENT

Part No.	Description	Price
751-HTP	Protects Metal or Plastic Pipe from Freezing	



ADS® SINGLE WALL DRAINAGE PIPE

ADS SLOTTED DRAINAGE PIPE

Part No.	Description	Price
0301-0100	3" ADS Slotted x 100' Coil	
0301-0300	3" ADS Slotted x 300' Coil	
0401-0100	4" ADS Slotted x 100' Coil	
0401-0250	4" ADS Slotted x 250' Coil	
0601-0100	6" ADS Slotted x 100' Coil	
0801-0020	8" ADS Slotted x 20' Stick	
1001-0020	10" ADS Slotted x 20' Stick	

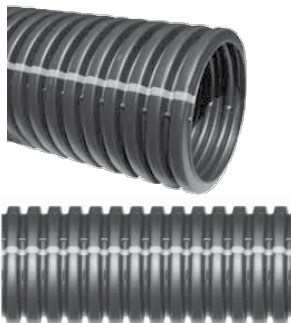

ADS SOLID DRAINAGE PIPE

Part No.	Description	Price
0351-0100	3" ADS Solid x 100' Coil	
0351-0300	3" ADS Solid x 300' Coil	
0451-0100	4" ADS Solid x 100' Coil	
0451-0250	4" ADS Solid x 250' Coil	
0651-0100	6" ADS Solid x 100' Coil	
0851-0020	8" ADS Solid x 20' Stick	
1051-0020	10" ADS Solid x 20' Stick	

DUAL WALL / N-12 SMOOTH INNER WALL PIPE ALSO AVAILABLE IN 4" & 60" SIZES.

ADS® SINGLE WALL PIPE FITTINGS

EXTERNAL COUPLER

Part No.	Size	Price
0312AA	3"	
0412AA	4"	
0612AA	6"	
0812AA	8"	
1012AA	10"	



SNAP END CAP

Part No.	Size	Price
0332AA	3"	
0432AA	4"	
0832AA	8"	
1032AA	10"	



REDUCING COUPLER

Part No.	Size	Price
0314AA	4" x 3"	
0614AA	6" x 4"	
0816AA	8" x 6"	
1018AA	10" x 8"	



BLIND TEE (ONE END)

Part No.	Size	Price
0341AA	3"	
0441AA	4"	
0641AA	6"	
0841AA	8"	
1041AA	10"	



SNAP TEE

Part No.	Size	Price
0321AA	3"	
0421AA	4"	
0626AA	6"	



MULTIPLE TEE

Part No.	Size	Price
0644AA	6" - 3", 4", 5", 6"	
0844AA	8" - 4", 5", 6", 8"	
1044AA	10" - 6", 8", 10"	



END PLUGS

Part No.	Size	Price
0333AA	3"	
0433AA	4"	
0434AA	4" Perf.	
0633AA	6"	



ELBOWS

Part No.	Size	Price
0390AA	3" - 90°	
0445AA	4" - 45°	
0490AA	4" - 90°	



WYES

Part No.	Size	Price
0322AA	3"	
0422AA	4"	
0622AA	6"	
0822AA	8"	



DOWNSPOUT ADAPTER

Part No.	Tube Size	Downspout	Price
0364AA	3"	3.25" x 2.5"	
0464AA	4"	4.25" x 2.5"	
0465AA	4"	4.25" x 3"	
0466AA	4"	2.56" x 2.56"	
0664AA	6"	4" x 6"	



DRAINTECH™ UNIVERSAL END PLUG

Part No.	Size	Price
0633SD	7.1 D x 1 H	



DRAINTECH™ 3" & 4" OFFSET LOCKING PIPE ADAPTER

Part No.	Size	Price
3411SD	7.1 D x 5.0 H	



Use to cap off unused outlets in DrainTech drain basins.

Use to attach 3" or 4" pipe to any size DrainTech drain basin.

INTRO | 1. ELECTRICAL | 2. PUMP, ACC. | 3. HOSE, PE PIPE & ACC. | 4. FPS, PIP PIPE & ACC. | 5. SURFACE | 6. SPRINKLERS | 7. TRAVELER & WHEEL MOVE | 8. PIVOT | 9. TURF | 10. LOW VOLUME | 11. FILTERS | 12. INJECTION | 13. HARDWARE | INDEX

DRAINTECH™ DRAIN BASINS & GRATES

6" ROUND 1 OR 2-HOLE BASIN

Use with 3" or 4" Corrugated Singlewall Pipe; 3" or 4" TripleWall Pipe; 3" or 4" PVC Pipe; Singlewall HDPE Fittings; and the grate types shown below. Use 6" pipe for a riser with this basin.

Part No.	Description	Dimensions Inches	Package Qty.	Price
0606SD1	6" Round 1-Hole Basin	9.2 L x 6.7 D x 7.8 H	5	
0606SD2	6" Round 2-Hole Basin	11.6 L x 6.7 D x 7.8 H	5	



6" ROUND & ATRIUM GRATES

Round Flat Grate: Use with 6" Round Basin, 6" Corrugated Singlewall Pipe or 6" PVC pipe.

Atrium Grate: Use in garden beds and other areas where floatable debris like mulch or leaves would clog a standard flat grate.

Part No.	Description	Dimensions Inches	Package Qty.	Price
0660SDB	6" Round Grate Black	6.7 D x 1.8 H	10	
0660SDG	6" Round Grate Green	6.7 D x 1.8 H	10	
0663SDB	6" Atrium Grate Black	6.7 D x 5.6 H	10	
0663SDG	6" Atrium Grate Green	6.7 D x 5.6 H	10	



9" SQUARE 2-HOLE BASIN

Use to collect medium-volume water flows from wet areas in yards, lawns, fairways and sports fields. Can also be used in patios, garages and driveways. Use with 3", 4" or 6" Corrugated Singlewall Pipe; 3" or 4" TripleWall Pipe; 3", 4" or 6" PVC Pipe; Singlewall HDPE Fittings; DrainTech 9" Square Riser; DrainTech Universal End Plug; DrainTech Pipe Adapters; and the grate types shown below.

Part No.	Description	Dimensions Inches	Package Qty.	Price
0909SD4	9" Square 2-Hole Basin	9.4 L x 9.4 D x 10.1 H	4	

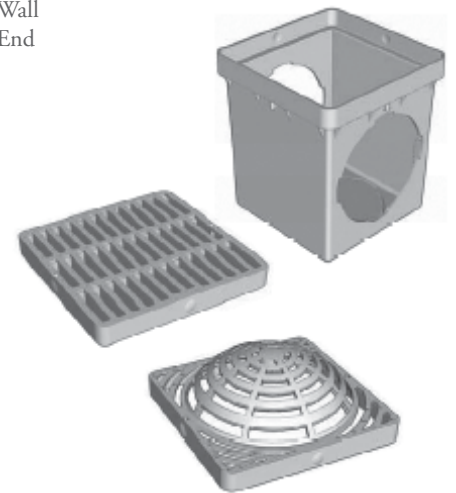

9" SQUARE & ATRIUM GRATES

Square Flat Grate: Use with 9" Square Basin.

Atrium Grate: Use in garden beds and other areas where floatable debris like mulch or leaves would clog a standard, flat grate. Use with 9" Square Basin.

Part No.	Description	Dimensions Inches	Package Qty.	Price
0902SDB	9" Square Grate Black	9.0 L x 9.0 D x 1.1 H	8	
0902SDG	9" Square Grate Green	9.0 L x 9.0 D x 1.1 H	8	
0903SDB	9" Atrium Grate Black	9.0 L x 9.0 D x 3.5 H	8	
0903SDG	9" Atrium Grate Green	9.0 L x 9.0 D x 3.5 H	8	

12" SQUARE 2-HOLE BASIN

Use to collect medium to high-volume water flows from wet areas in yards, lawns, fairways and sports fields. Can also be used in patios, garages and driveways. Use with 3", 4", 6" or 8" Corrugated Singlewall Pipe; 3" or 4" TripleWall Pipe; 3", 4", 6" or 8" PVC Pipe; Singlewall HDPE Fittings; DrainTech 12" Square Riser, Drain Tech Universal End Plug; DrainTech Pipe Adapters; and the grate types shown below.

Part No.	Description	Dimensions Inches	Package Qty.	Price
1212SD2	12" Square 2-Hole Basin	12.1 L x 12.1 D x 12.8 H	4	

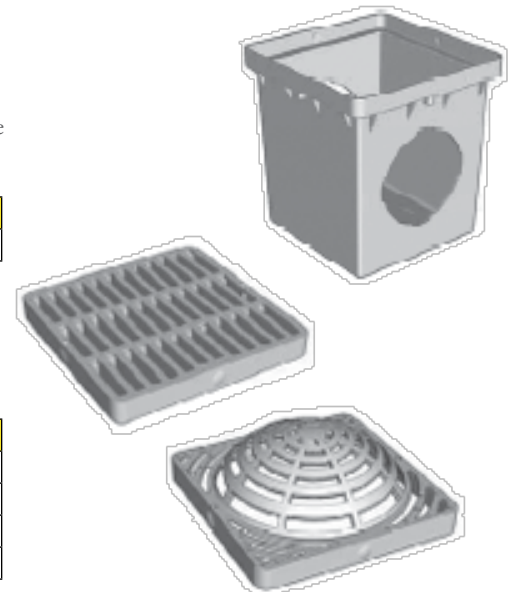

12" SQUARE & ATRIUM GRATES

Square Flat Grate: Use with 12" Square Basin.

Atrium Grate: Use in garden beds and other areas where floatable debris like mulch or leaves would clog a standard, flat grate. Use with 12" Square Basin.

Part No.	Description	Dimensions Inches	Package Qty.	Price
1202SDB	12" Square Grate Black	11.8 L x 11.8 D x 1.1 H	8	
1202SDG	12" Square Grate Green	11.8 L x 11.8 D x 1.1 H	8	
1203SDB	12" Atrium Grate Black	11.8 L x 11.8 D x 4.6 H	8	
1203SDG	12" Atrium Grate Green	11.8 L x 11.8 D x 4.6 H	8	

BUSHMAN RAIN WATER HARVESTING

Rainwater harvesting has been around for decades, but only recently has it received national attention due to water shortages throughout the United States. Since harvesting rainwater is relatively new to the USA, many of the available tanks and barrels are not suitable for the average home and garden; they are either too small or too large.

With this in mind, Bushman has designed rainwater harvesting tanks that may be a better fit for your smaller residential and commercial needs. We offer two lines of tanks, including a Slimline Series and a Round Series, which allow customers to choose which style fits their application best. All tanks come with features and benefits that set them apart from conventional farm tanks, allowing customers to store rainwater safely for months at a time.

TANK CODES & COLORS

C3= GREEN

C4=MOCHA

C5=RED

C7=TAUPE

C8=DARK MOSS

C9=TERRA COTTA

CRB-60	60 GALLON RAIN BARREL	
Part No.	Description	Price
CRB60C7P2	60 Gallon rain barrel includes diverter kit to connect to downspout plus spigot and hose adapter fitting.	
CRB60C8P2		
CRB60C9P2		



BSLT-130	130 GALLON SLIM LINE TANK	
Part No.	Description	Price
BLST130C3P1	Tank includes inlet strainer and cover, one 1" lower threaded outlet with plug, one 3/4" outlet with spigot, one overflow assembly with mosquito mesh, and one accessory port.	
BLST130C4P1		
BLST130C5P1		



BRTT-205	205 GALLON ROUND TALL TANK	
Part No.	Description	Price
BRTT205C3P1	Tank includes inlet strainer and cover, two lower 1" threaded bulkhead outlets with plugs, overflow assembly with mosquito mesh.	
BRTT205C4P1		
BRTT205C5P1		



BSLT-265E	265 GALLON SLIM LINE TANK - (NEW)	
Part No.	Description	Price
BSLT265EC3P1	Tank includes inlet strainer and cover, two 1" lower bulkhead fittings, overflow assembly with mosquito mesh, and one accessory port.	
BSLT265EC4P1		
BSLT265EC5P1		



BRTT-420	420 ROUND TALL TANK - (NEW)	
Part No.	Description	Price
BRTT420C3P1	Tank includes inlet strainer and cover, two lower 1" threaded bulkhead outlets with plugs, overflow assembly with mosquito mesh.	
BRTT420C4P1		
BRTT420C5P1		



BSLT-530E	530 GALLON SLIM LINE TANK - (NEW)	
Part No.	Description	Price
BSLT530EC3P1	Tank includes inlet strainer and cover, two 1" lower bulkhead fittings, overflow assembly with mosquito mesh, and one accessory port.	
BSLT530EC4P1		
BSLT530EC5P1		



- 1. ELECTRICAL
- 2. PUMP ACC.
- 3. HOSE, PE PIPE & ACC.
- 4. IPS, PIP PIPE & ACC.
- 5. SURFACE
- 6. SPRINKLERS
- 7. TRAVELER & WHEEL MOVE
- 8. PIVOT
- 9. TURF
- 10. LOW VOLUME
- 11. FILTERS
- 12. INJECTION
- 13. HARDWARE
- INDEX

RAIN WATER TANKS

BUSHMAN RAIN WATER HARVESTING

BLPT-660E 660 GALLON LOW PROFILE ROUND TANK		
Part No.	Description	Price
BLPT660C3P1	Tank includes inlet strainer and cover, two 1" lower bulkhead fittings, overflow assembly with mosquito mesh, and one accessory port.	
BLPT660C4P1		
BLPT660C5P1		



BRTT-865 865 GALLON ROUND TALL TANK		
Part No.	Description	Price
BRTT865C3P1	Tank includes inlet strainer and cover, two 1" lower bulkhead fittings, overflow assembly with mosquito mesh, and one accessory port.	
BRTT865C4P1		
BRTT865C5P1		



BLPT-1110 1110 GALLON LOW PROFILE ROUND TANK		
Part No.	Description	Price
BLPT1110C3P1	Tank includes inlet strainer and cover, two 1" lower bulkhead fittings, overflow assembly with mosquito mesh, and one accessory port.	
BLPT1110C4P1		
BLPT1110C5P1		



BLPT-1320 1320 GALLON LOW PROFILE ROUND TANK		
Part No.	Description	Price
BLPT1320C3P1	Tank includes inlet strainer and cover, two 1" lower bulkhead fittings, overflow assembly with mosquito mesh, and one accessory port.	
BLPT1320C4P1		
BLPT1320C5P1		



BRTT-2825 2825 GALLON ROUND TALL TANK		
Part No.	Description	Price
BRTT2825C3P1	Tank includes inlet strainer and cover, two 1" lower bulkhead fittings, overflow assembly with mosquito mesh, and one accessory port.	
BRTT2825C4P1		
BRTT2825C5P1		



KITS & ACCESSORIES		
Part No.	Description	Price
BCK0001	Bushman Connection Kit - Standard	
BCK0002	Bushman Connection Kit - BSLT 130 Tank Only	
BCK0003	Bushman Connection Kit - Contractor - Debris Separator, First Flush Filter Assembly Only	
BPK1225CXP1A01	Pump Kit - To Specify Color Replace CX with: C0 Black - C3 Forest Green - C4 Mocha Brown - C5 Brick Red	
BTA9780	Pump Only	
BFH-K01	Flex Hose Kit - Connect Multiple Tanks Together to Increase Capacity	
BTP-K01	Bushman Tri-Port Auto Fill Kit - Includes Tri-Port Plate Assembly with Check Valve and Auto Fill Valve	
BCS12001	Filter Assembly for Bushman Water Diverter Kit - Sold in Case of 12 Only	
BCS12006	Overflow Assembly with Mosquito Screen, C-Plate, Gasket, and Hardware - Sold in Case of 12 Only	
BCS12003	Debris Separator and Screen - Sold in Case of 122 Only	

COMPOST TEA

Part No.	Description	Price
COMPOST-T-GA	Organic liquid fertilizer made of Liquid Compost, Liquid Humate, Orange Oil, and Molasses	



MULCH

Part No.	Description	Price
Cedar Mulch	2 CU. FT. DBL GRND 55 Pallet	
Hard Wood Mulch	3 CU FT Hardwood Mulch 40" Pallet	

KING DRAINS® AUTOMATIC DRAIN VALVE

Part No.	Description	Price
22163	1/2" MPT Inlet	
23167	3/4" MPT Inlet	



RAIN BIRD® AUTOMATIC DRAIN VALVE

Part No.	Description	Price
16AFDV	1/2" MPT Inlet	
16AFDV075	3/4" MPT Inlet	



CHRISTY TERRY TOWELS

Part No.	Description	Price
TC-RAGS	Terry Towels	



RAIN BIRD® TOOLS

Part No.	Description	Price
ROTORTOOL	Flat Blade Screw Drive and Pull Up Tool	
PTC-1	Spray Head Pull-up Tool	



HUNTER® ADJUSTMENT TOOL

Part No.	Description	Price
172000	Hunter PGP Adjustment Tool	



HUNTER® T HANDLE TOOL

Part No.	Description	Price
D53191	Nozzle Insertion, Lift-up and Arc Adjustment Tool for Most Rotors	



HOLD UP TOOL

Part No.	Description	Price
123200	Hunter® Nozzle Insertion Collar Works On All Rotors Except PGJ, I-60 and I-90	
HOLDUPTOOL	Rain Bird® Hold Up Tool with Bubble Level Works with 5000, 5500, Falcon®, 6504, 7005 and 8005	



INTRO
 1. ELECTRICAL
 2. PUMP Acc.
 3. HOSE, PE PIPE & Acc.
 4. IPS, PIP Pipe & Acc.
 5. SURFACE
 6. SPRINKLERS
 7. TRAVELER & WHEEL MOVE
 8. PIVOT
 9. TURF
 10. LOW VOLUME
 11. FILTERS
 12. INJECTION
 13. HARDWARE
 INDEX

SPRINKLER BASES



GS1 GEAR DRIVE SPRINKLER

- Easily adjustable full or part circle operation
- Waters up to 72 feet
- Operating pressure: 15 - 60 PSI. Best operation at 35 PSI
- Slides easily to relocate
- Stable in use
- Includes quick snap-on hose connector

Part No.	Description	Price
17055	Full or Part Circle Gear Drive Sprinkler w/Base	



SPRINKLER ASSEMBLY

Part No.	Description	Price
208-B46100-08	Plastic Hose Thread Weighted Sled Base with Maxi-Bird	
208-10662-1360	Plastic Hose Thread Weighted Sled Base with MP Rotator®	
208-WOBLA1/2M	Plastic Hose Thread Weighted Sled Base with Wobbler®	



SPRINKLER BASE

Part No.	Description	Price
208	Plastic Hose Thread Weighted Sled Base with 1/2" FIPT Outlet	
208-WOB-11	Sled base with Wobbler w/noz	
167SMB	Metal Base with Impact Sprinkler	
WB05	Red Pipe Base with 1/2" FIPT Outlet	
WB07	Red Pipe Base with 3/4" FIPT Outlet	
MST-TRI-050	Trident 500 Aluminum Base with 1/2" FIPT Outlet	
MST-TRI-075	Trident 750 Aluminum Base with 3/4" FIPT Outlet	

Please specify which nozzle you would like.

JOHN DEERE™ GUZZLER HAND SUCTION PUMP

Part No.	Description	Price
DN100G	2" Dia. x 9" Hand Suction Pump for Small Cavity Water Removal	



BECKSON UTILITY HAND SUCTION PUMP

Part No.	Description	Price
136PF-6	1-3/4" Dia. x 36" Hand Suction Pump with 35 oz. Stroke and 1-1/4" x 72" Hose	



KING INNOVATION® UTILITY HAND SUCTION PUMP

Part No.	Description	Price
48024	24" Pump x 36" Hose Package of 1	
48036	36" Pump x 36" Hose Package of 1	
48072	36" Pump x 72" Hose Package of 1	



- Corrosion proof
- Self-priming, lightweight utility pump
- Removable intake foot for easy cleaning
- Large, easy grip, ergonomic handle
- Includes 36" or 72" flexible discharge hose for directing water evacuation
- 4 strokes per gallon provides quick removal of water
- Perfect for removing water from irrigation valve boxes, meter pits, pipe trenches, and anywhere water accumulates

INTRO
1. ELECTRICAL
2. PUMP ACC.
3. HOSE, PE PIPE & ACC.
4. IPS, PIP PIPE & ACC.
5. SURFACE
6. SPRINKLERS
7. TRAVELER & WHEEL MOVE
8. PIVOT
9. TURF
10. LOW VOLUME
11. FILTERS
12. INJECTION
13. HARDWARE
INDEX

MARKING FLAGS, TAPE, PAINT AND ACCESSORIES

MARKING FLAGS

Whether your use is for staking pipelines, wire, valves, sprinkler locations, pivot points or any other use, you're sure to be satisfied with the quality of these marking flags. Made from durable 4 mil plastic sheeting, they will stand up to sun, wind and inclement weather. The plastic flags will stay on the staffs and the colors won't fade. Flags are 4" x 5" and attached to a sturdy 15.5 gauge 21" steel wire staff. Sold only in bundles of 100 flags. Standard colors are listed below, however additional colors are available by special order.

Part No.	Color	Size	100-900	1000+
FLAG-RED-1C	Red	Flag 4" x 5" Staff 21"	Per Bundle of 100 Flags	Per Bundle of 100 Flags
FLAG-WHT-1C	White			
FLAG-YEL-1C	Yellow			
FLAG-ORG-1C	Orange			
FLAG-BLU-1C	Blue			
FLAG-GRN-1C	Green			
FLAG-SIL-1C	Silver			
FLAG-PPL-1C	Purple			
FLAG-FLP-1C	Flr. Pink			
FLAG-FLO-1C	Flr. Orange			



Note: Additional flag sizes, staff lengths & custom flags available upon request.

MARKING TAPE

Made from fade resistant color saturated 2.5 mil PVC, this fluorescent orange tape is a bold and vibrant color, making it easy to see. Additional colors available are white and blue.

Part No.	Description	Price
TFOG	1-3/16" x 300' Roll, Fluorescent Orange	
TFW	1-3/16" x 300' Roll, Fluorescent White	
TFB	1-3/16" x 300' Roll, Fluorescent Blue	



PRINTED MARKING TAPE

Custom and Standard prints are available to fit your needs. Many additional colors available upon request.

Part No.	Description	Price
CU-BLK-XX	1-1/2" x 300' Roll, Black	
CU-BLU-XX	1-1/2" x 300' Roll, Blue	
CU-GRN-XX	1-1/2" x 300' Roll, Green	
CU-RED-XX	1-1/2" x 300' Roll, Red	



DAY NIGHT VISIBILITY FLAGGING

Part No.	Description	Price
SOGREF	1-3/16" x 150' Roll, Orange Glow	

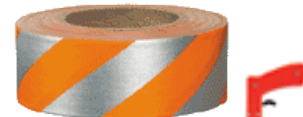

MARKING PAINT & MARKING TOOLS

This economical paint is lead free and APWA approved.

Part No.	Description	Price
S03610	Fluorescent RED Marking Paint	
S03612	Fluorescent PINK Marking Paint	
S03700	Fluorescent ORANGE Paint	
S03722	Fluorescent BLUE Marking Paint	
S03801	Fluorescent YELLOW Marking Paint	
S03901	Fluorescent WHITE Marking Paint	
MW34	34" Marking Paint Wand	



BARRICADE TAPE

Part No.	Description	Price
B332XX	2 Mil. 3" x 300' Polyethylene	
B3102XX	2 Mil. 3" x 1000' Polyethylene	
B3322XX	2.5 Mil. 3" x 300' Polyethylene	
B31022XX	2.5 Mil. 3" x 1000' Polyethylene	
B333XX	3 Mil. 3" x 300' Polyethylene	
B3103XX	3 Mil. 3" x 1000' Polyethylene	

XX = Color and wording

Colors Available: Black, Blue, Green, Orange, Red, White, Yellow, Yellow/Black Striped.

Prints Include: Caution, Caution Do Not Enter, Danger, Danger Do Not Enter, and many others.

Materials Available: Biodegradable Cellulosic and Woven Polypropylene.

Easy to tear off markers & pennant flags also available.



ADHESIVE MARKING TAPE

Part No.	Color	Description	Price
A2SWBK18	White / Black	Hazard Warning Tape 6 Mil. 2" 18 Yards	
A2SWBK36	White / Black	Hazard Warning Tape 6 Mil. 2" 36 Yards	
A2SWR18	White / Red	Hazard Warning Tape 6 Mil. 2" 18 Yards	
A2SWR36	White / Red	Hazard Warning Tape 6 Mil. 2" 36 Yards	
A2SYBK18	Black / Yellow	Hazard Warning Tape 6 Mil. 2" 18 Yards	
A2SYBK36	Black / Yellow	Hazard Warning Tape 6 Mil. 2" 36 Yards	



AISLE MARKING TAPE

Part No.	Color	Description	Price
A2BK36	Black	Aisle Marking Tape Solid 6 Mil. 2" 36 Yards	
A2B36	Blue	Aisle Marking Tape Solid 6 Mil. 2" 36 Yards	
A2G36	Green	Aisle Marking Tape Solid 6 Mil. 2" 36 Yards	
A2R36	Red	Aisle Marking Tape Solid 6 Mil. 2" 36 Yards	
A2W36	White	Aisle Marking Tape Solid 6 Mil. 2" 36 Yards	
A2Y36	Yellow	Aisle Marking Tape Solid 6 Mil. 2" 36 Yards	



DETECTABLE UNDERGROUND WARNING TAPE

For accurately locating & preventing damage to underground utility installations with aluminum backing to make underground assets easy to find using a non-ferrous locator. Standard prints are available.

Part No.	Description	Price
D2105XX	5 Mil. 2" x 1000'	
D3105XX	5 Mil. 3" x 1000'	
D6105XX	5 Mil. 6" x 1000'	

XX = Color and wording



NON DETECTABLE UNDERGROUND WARNING TAPE

Part No.	Description	Price
B3104XX	4 Mil. 3" x 1000'	
B6104XX	4 Mil. 6" x 1000'	

XX = Color and wording

Available in Blue, Green, Orange, Purple, Red, Yellow and Black. Made of highly visible polyethylene material. Custom print and numerous standard legends are available.



INTRO
1. ELECTRICAL
2. PUMP Acc.
3. HOSE, PE PIPE & Acc.
4. IPS, PIP Pipe & Acc.
5. SURFACE
6. SPRINKLERS
7. TRAVELER & WHEEL MOVE
8. PIVOT
9. TURF
10. LOW VOLUME
11. FILTERS
12. INJECTION
13. HARDWARE
INDEX

SECTION 10

Low Volume Irrigation

CONTENTS

- 10:4 POLYETHYLENE BLANK TUBING
- 10:5 POLYETHYLENE BLANK TUBING & DRIP TUBING
- 10:6-7 DRIP TUBING
- 10:8-9 DRIP TAPE
- 10:8 NETAFIM™ STREAMLINE THINWALL DRIPPERLINE
- 10:8 NETAFIM™ TYPHOON THINWALL DRIPPERLINE
- 10:9 EURODRIP® SEAMLESS DRIP TAPE
- 10:10-11 EMITTERS
- 10:10 BOWSMITH® EMITTERS
- 10:11 TORO® AG EMITTERS
- 10:11 RAIN BIRD® EMITTERS
- 10:11 NETAFIM™ ON-LINE DRIPPERS
- 10:11 SUBMATIC ORIFICE EMITTERS
- 10:12 DRIP KITS
- 10:13-21 MICRO SPRINKLERS
- 10:13 ANTELCO® ADJUSTABLE FLOW & RAIN BIRD® XERI-BUBBLER™ PRODUCTS
- 10:14 BOWSMITH FAN-JET®
- 10:15 BOWSMITH FAN-JET®
- 10:16 ANTELCO® JET PRODUCTS
- 10:16 OLSON JET PRODUCTS
- 10:17 MICRO SPRINKLER PRODUCTS
- 10:18 MICRO SPRINKLER PRODUCTS
- 10:18 NELSON R5 POP UP ROTATOR® PRODUCTS
- 10:19 NELSON R5 ROTATOR® PRODUCTS
- 10:20 NELSON R5 ROTATOR® FEEDTUBE ASSEMBLIES & ACCESSORIES
- 10:21 NELSON R5 ROTATOR® FEEDTUBE ASSEMBLIES & ACCESSORIES
- 10:21 5MM FEEDTUBE OPTIONS FOR THE R5 &R10
- 10:22 FOGGERS & MISTERS
- 10:23-24 NURSERY SPRAY STICKS
- 10:25-26 PRESSURE REGULATORS
- 10:27-29 COMPRESSION FITTINGS
- 10:30-34 POWER-LOC™ FITTINGS
- 10:35-37 TAPE-LOC® FITTINGS
- 10:38 TWIST-LOCK FITTINGS™
- 10:39 INSERT & CONNECTOR FITTINGS
- 10:40 INSERT & CONNECTOR FITTINGS AND OUTLET ADAPTERS
- 10:41 RISER TUBING AND WIRE TIES
- 10:42-46 CONTROL VALVES
- 10:42 BERHAD CONTROL VALVES
- 10:42 NETAFIM™ CONTROL VALVES
- 10:43 RAIN BIRD® CONTROL VALVES
- 10:43 TORO® AG CONTROL VALVES
- 10:43 CONTROL ZONE KIT ASSEMBLY
- 10:44 NELSON 800 SERIES CONTROL VALVES
- 10:45 NETAFIM™ CONTROL VALVES
- 10:46 XCAD AUTOMATIC CONTROL VALVES
- 10:47-48 CONTROLLERS
- 10:47 EDSTROM CONTROLLERS
- 10:47 RAINMASTER CONTROLLERS
- 10:47 TORO® AG CONTROLLERS
- 10:48 SUPERIOR STERLING CONTROLLERS
- 10:48 BERHAD CONTROLLERS
- 10:48 NETAFIM™ CONTROLLERS
- 10:49 HOSE THREAD SHUT-OFF VALVES & QUICK CONNECTORS



POLYETHYLENE BLANK TUBING

Our Polyethylene Tubing is extruded exclusively from virgin linear low density polyethylene (LLDPE) base resin and combined with a suitable virgin carbon concentrate compound to provide a minimum of 2% carbon black, which is blended, mixed and dispersed into the finished product for maximum UV protection. Strict quality control procedures followed during the extrusion process ensure the highest uniformity and product quality. Because the tubing is a vital and integral part of your irrigation system, we will only distribute the highest quality, most reliable and dependable premium drip irrigation tubing available in the market.



SHORT COILED POLYETHYLENE TUBING

Part No.	Model No.	Description	O.D.	I.D.	Price
SW-455-100	455P40-1C	3/8" Poly x 100'	0.455"	0.375"	
SW-455-500	455P40-5C	3/8" Poly x 500'	0.455"	0.375"	
SW-700-100	700P50-1C	1/2" Poly x 100'	0.700"	0.600"	
SW-940-100	935P62-1C	3/4" Poly x 100'	0.935"	0.811"	

BOWSMITH POLYETHYLENE TUBING

Part No.	Model No.	Description	O.D.	I.D.	Price
9444	625P50-1M	16mm Poly x 1000'	0.625"	0.525"	
9411	700P50-5C	1/2" Poly x 500'	0.700"	0.600"	
9433	700P50-1M	1/2" Poly x 1000'	0.700"	0.600"	
9435	720P48-1M	18mm Poly x 1000'	0.720"	0.625"	
9439	835P52-1M	5/8" Poly x 1000'	0.835"	0.730"	
9414	935P62-5C	3/4" Poly x 500'	0.935"	0.811"	
9438	935P62-1M	3/4" Poly x 1000'	0.935"	0.811"	
9443	3/4P50-1M	3/4" Poly x 1000'	0.935"	0.818"	
9441	1195P72-5C	1" Poly x 500'	1.195"	1.050"	

NETAFIM™ POLYETHYLENE TUBING

Part No.	Model No.	Description	O.D.	I.D.	Price
40510-000002	14037045	3/8" Poly x 1000'	0.455"	0.375"	
40510-000003	14052062	16mm Poly x 1000'	0.620"	0.520"	
40510-000005	14060070	1/2" Poly x 1000'	0.700"	0.600"	
40510-000036	14060070-05	1/2" Poly x 500'	0.700"	0.600"	
40510-000009	14069079	20mm Poly x 1000'	0.790"	0.690"	
14070080	14070080	21mm Poly x 1000'	0.800"	0.700"	
14072084	14072084	5/8" Poly x 1000'	0.840"	0.720"	
40510-000018	14082094	3/4" Poly x 500'	0.940"	0.820"	
14082094-1000	14082094-1000	3/4" Poly x 1000'	0.940"	0.820"	
40510-000020	14106120	1" Poly x 500'	1.200"	1.060"	

JAIN® POLYETHYLENE TUBING

Part No.	Model No.	Description	O.D.	I.D.	Price
11190529	455X375-100PE	3/8" Poly x 100'	.455	.375	
11190531	455X375-500PE	3/8" Poly x 500'	.455	.375	
11200002	700X600-100PE	1/2" Poly x 100'	.700	.600	
11200061	620X520-100PE	16mm Poly x 100'	0.620"	0.520"	
11200064	620X520-500PE	16mm Poly x 500'	0.620"	0.520"	
11200067	620X520-1000PE	16mm Poly x 1000'	0.620"	0.520"	

MICRO TUBING

SMALL DIAMETER VINYL & POLYETHYLENE (P.E.) TUBING

Part No.	Model No.	Description	O.D.	I.D.	Price
11190661	125X063-3500PE	1/8" P.E. Micro Tube x 3500'	0.125"	0.063"	
11190663	128X076-3500PE	1/8" P.E. Micro Tube x 3500'	0.128"	0.076"	
SW185-100	SW-185-100PE	1/8" SWISH STIK™ P.E. Tube x 100'	0.185"	0.125"	
SW185-1000	SW-185-1000PE	1/8" SWISH STIK™ P.E. Tube x 1000'	0.185"	0.125"	
11190149	187X125-100PE	.187" x .125" P.E. Micro Tube x 100'	0.187"	0.125"	
11190589	187X125-1000PE	.187" x .125" P.E. Micro Tube x 1000'	0.187"	0.125"	
11190593	188X128-3000PE	.188" x .128" # 3 Chapin P.E. Micro Tube x 3000'	0.188"	0.128"	
11190255	220X160-100PE	.220" x .160" P.E. Micro Tube x 100'	0.220"	0.160"	
11190595	220X160-1000PE	.220" x .160" P.E. Micro Tube x 1000'	0.220"	0.160"	
11190042	220X160-100V	.220" x .160" Vinyl Tube x 100'	0.220"	0.160"	
11190597	220X160-1000V	.220" x .160" Vinyl Tube x 1000'	0.220"	0.160"	
11190609	225X155-2500PE	.225" x .155" # 4 Chapin P.E. Micro Tube x 2500'	0.225"	0.155"	
558	245X160-1250PE	.245" x .160" P.E. Micro Tube x 1250'	0.245"	0.160"	
SW-250-100	RXO-250H-100	.250" x .125" Hydraulic Tubing x 100'	0.250"	0.125"	
SW-250-1000	RXO-250H-1000	.250" x .125" Hydraulic Tubing x 1000'	0.250"	0.125"	
SW-250-3000	RXO-250H-3000	.250" x .125" Hydraulic Tubing x 3000'	0.250"	0.125"	
607	250X140-1000V	.250" x .140" Vinyl Micro Tube x 1000'	0.250"	0.140"	
DRXO-250-100	RXO-250-100	.250" x .170" Relax-O Micro Tube x 100'	0.250"	0.170"	
DRXO-250-1000	RXO-250-1000	.250" x .170" Relax-O Micro Tube x 1000'	0.250"	0.170"	
11190334	250X170-100PE	.250" x .170" P.E. Micro Tube x 100'	0.250"	0.170"	
11190601	250X170-2000PE	.250" x .170" P.E. Micro Tube x 2000'	0.250"	0.170"	
11190351	250X170-100V	.250" x .170" Vinyl Micro Tube x 100'	0.250"	0.170"	
11190602	250X170-1000V	.250" x .170" Vinyl Micro Tube x 1000'	0.250"	0.170"	
11190614	272X188-1500PE	.272" x .188" # 4.5 Chapin P.E. Micro Tube x 1500'	0.272"	0.188"	
11190616	275X210-1500PE	.275" x .210" # 5 Chapin P.E. Micro Tube x 1500'	0.275"	0.210"	
11190621	350X250-500PE	.350" x .250" P.E. Micro Tube x 500'	0.350"	0.250"	

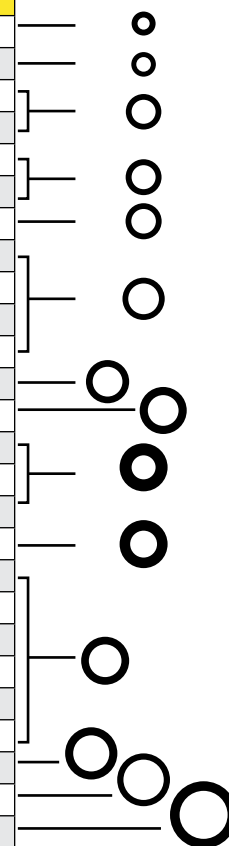

DRIP TUBING

NETAFIM™ TECHLINE® CV PRESSURE COMPENSATING LANDSCAPE DRIPPERLINE

Netafim™ Techline® CV is a market leader in landscape dripperline. Colored brown to make it less visible in landscape applications, this very flexible dripperline has a minimum bend radius of 7". This dripperline is self cleaning, UV resistant and each dripper has a 2 PSI Check Valve. This means that all drippers turn on and off at the same time. The Techline® CV minimizes water loss, holds back up to 4-1/2 feet of water, is great on slopes, provides more precise watering, and has a built-in physical root barrier. Please call for quote on special pricing and large quantities.

Part No.	Model No.	Description	O.D.	I.D.	Price
14696-0000XX	TLCV#-1210	17mm, 12" Spacing, 1000'	0.66"	0.56"	
14696-0000XX	TLCV#-12025	17mm, 12" Spacing, 250'	0.66"	0.56"	
14696-0000XX	TLCV#-1201	17mm, 12" Spacing, 100'	0.66"	0.56"	
14696-0000XX	TLCV#-1810	17mm, 18" Spacing, 1000'	0.66"	0.56"	
14696-0000XX	TLCV#-18025	17mm, 18" Spacing, 250'	0.66"	0.56"	
14696-0000XX	TLCV#-1801	17mm, 18" Spacing, 100'	0.66"	0.56"	
14696-0000XX	TLCV#-2410	17mm, 24" Spacing, 1000'	0.66"	0.56"	
14696-0000XX	TLCV#-24025	17mm, 24" Spacing, 250'	0.66"	0.56"	
14696-0000XX	TLCV#-2401	17mm, 24" Spacing, 100'	0.66"	0.56"	
14696-000034	TLCV001	17mm, Blank Tubing, 100'	0.66"	0.56"	



Order by Model No.

Denotes flow rate (GPH), flow rates available 0.4, 0.6, 0.9 GPH

DRIP TUBING

RAIN BIRD® XFD™ 16MM SERIES LANDSCAPE DRIPLINE TUBING

Part No.	Description	O.D.	I.D.	Price
XFD-##-12-100	16mm, 12" Spacing, 100'	0.63"	0.54"	
XFD-##-12-250	16mm, 12" Spacing, 250'	0.63"	0.54"	
XFD-##-12-500	16mm, 12" Spacing, 500'	0.63"	0.54"	
XFDP-##-12-500	16mm, 12" Spacing, 500' (Purple)	0.63"	0.54"	
XFD-##-18-100	16mm, 18" Spacing, 100'	0.63"	0.54"	
XFD-##-18-250	16mm, 18" Spacing, 250'	0.63"	0.54"	
XFD-##-18-500	16mm, 18" Spacing, 500'	0.63"	0.54"	
XFDP-##-18-500	16mm, 18" Spacing, 500' (Purple)	0.63"	0.54"	
XFD-##-24-100	16mm, 24" Spacing, 100'	0.63"	0.54"	
XFD-##-24-250	16mm, 24" Spacing, 250'	0.63"	0.54"	
XFD-##-24-500	16mm, 24" Spacing, 500'	0.63"	0.54"	
XFDP-##-24-500	16mm, 24" Spacing, 500' (Purple)	0.63"	0.54"	

Denotes flow rate (GPH), flow rates available 0.6, 0.9 GPH



RAIN BIRD® XQ .25" POLYETHYLENE DISTRIBUTION TUBING

Part No.	Model No.	Description	O.D.	I.D.	Price
X33010	XQ100	1/4" Tubing 100'	0.25"	0.17"	
X33100	XQ1000	1/4" Tubing 1000'	0.25"	0.17"	
X33101	XQ1000B	1/4" Tubing 1000' In Bucket	0.25"	0.17"	

Order by Model No.



RAIN BIRD® XFS™ 16MM SERIES SUB-SURFACE DRIPLINE TUBING

Part No.	Description	O.D.	I.D.	Price
XFS-##-12-100	16mm, 12" Spacing, 100'	0.63"	0.54"	
XFS-##-12-500	16mm, 12" Spacing, 500'	0.63"	0.54"	
XFS-P-##-12-500	16mm, 12" Spacing, 500' (Purple)	0.63"	0.54"	
XFS-##-18-100	16mm, 18" Spacing, 100'	0.63"	0.54"	
XFS-##-18-500	16mm, 18" Spacing, 500'	0.63"	0.54"	
XFS-P-##-18-500	16mm, 18" Spacing, 500' (Purple)	0.63"	0.54"	
XFS-##-24-500	16mm, 24" Spacing, 500'	0.63"	0.54"	

Denotes flow rate (GPH), flow rates available 0.6, 0.9 GPH



RAIN BIRD® A5 PC™ SERIES PRESSURE COMPENSATING DRIPLINE TUBING

Part No.	Description	O.D.	I.D.	Price
A5-1635-##-XX	16mm (.035") wall thickness	0.610	0.540	
A5-1645-##-XX	16mm (.045") wall thickness	0.630	0.540	
A5-18-##-XX	18mm (.045") wall thickness	0.709	0.619	
A5-20-##-XX	20mm (.050") wall thickness	0.787	0.687	

Denotes Flow Rates: XX Emitter Spacing:
 04 = 0.42 GPH (1.6 l/h) 18 = 18"
 05 = 0.53 GPH (2.0 l/h) 24 = 24"
 06 = 0.61 GPH (2.3 l/h) 30 = 30"
 10 = 1.06 GPH (4.0 l/h) 36 = 36"
 42 = 42"
 48 = 48"
 60 = 60"



BOWSMITH "PCI" SERIES 18MM PC INLINE DRIP TUBING

Part No.	Description	O.D.	I.D.	Price
PCI-18-##-24-1000	18mm, 24" Spacing, 1000'	0.71"	0.62"	
PCI-18-##-36-1000	18mm, 36" Spacing, 1000'	0.71"	0.62"	
PCI-18-##-48-1000	18mm, 48" Spacing, 1000'	0.71"	0.62"	

Denotes flow rate (GPH), flow rates available 0.53, 1.0 GPH



DRIP TUBING

JAIN® AQUA-LINE™ PC INLINE EMITTERLINE

Part No.	Model No.	Description	O.D.	I.D.	Weight Lbs.	Price
11500192	A16-2-12PC-500	16mm, 12" Spacing, .5 GPH, 500'	0.633"	0.543"	23	
11500119	A16-2-18PC-100	16mm, 18" Spacing, .5 GPH, 100'	0.633"	0.543"	4.3	
11500118	A16-2-18PC-100B	16mm, 18" Spacing, .5 GPH, 100' Brown	0.633"	0.543"	4.3	
11500116	A16-2-18PC-500B	16mm, 18" Spacing, .5 GPH, 500' Brown	0.633"	0.543"	21.5	
11500113	A16-2-24PC-100	16mm, 24" Spacing, .5 GPH, 100'	0.633"	0.543"	4.3	
11500112	A16-2-24PC-100B	16mm, 24" Spacing, .5 GPH, 100' Brown	0.633"	0.543"	4.3	
11500091	A16-4-12PC-100	16mm, 12" Spacing, 1 GPH, 100'	0.633"	0.543"	4.6	
11500090	A16-4-12PC-100B	16mm, 12" Spacing, 1 GPH, 100' Brown	0.633"	0.543"	4.6	
11500079	A16-4-12PC-500	16mm, 12" Spacing, 1 GPH, 500'	0.633"	0.543"	21	
11500080	A16-4-12PC-500B	16mm, 12" Spacing, 1 GPH, 500' Brown	0.633"	0.543"	21	
11500093	A16-4-18PC-100	16mm, 18" Spacing, 1 GPH, 100'	0.633"	0.543"	4.3	
11500083	A16-4-18PC-500	16mm, 18" Spacing, 1 GPH, 500'	0.633"	0.543"	21.5	
11500084	A16-4-18PC-500B	16mm, 18" Spacing, 1 GPH, 500' Brown	0.633"	0.543"	21.5	
11500095	A16-4-24PC-100	16mm, 24" Spacing, 1 GPH, 100'	0.633"	0.543"	4.2	
11500088	A16-4-24PC-500B	16mm, 24" Spacing, 1 GPH, 500' Brown	0.633"	0.543"	21	
11500265	A18-2-12PC-100	18mm, 12" Spacing, .5 GPH, 100'	0.710"	0.620"	4.6	
11500263	A18-2-12PC-500	18mm, 12" Spacing, .5 GPH, 500'	0.710"	0.620"	23	
11500261	A18-2-24PC-1000	18mm, 24" Spacing, .5 GPH, 1000'	0.710"	0.620"	42	
11500245	A18-2-30PC-1000	18mm, 30" Spacing, .5 GPH, 1000'	0.710"	0.620"	41	
11500260	A18-2-36PC-1000	18mm, 36" Spacing, .5 GPH, 1000'	0.710"	0.620"	40	
11500267	A18-4-12PC-100	18mm, 12" Spacing, 1 GPH, 100'	0.710"	0.620"	4.6	
11500256	A18-4-18PC-1000	18mm, 18" Spacing, 1 GPH, 1000'	0.710"	0.620"	44	
11500255	A18-4-24PC-1000	18mm, 24" Spacing, 1 GPH, 1000'	0.710"	0.620"	42	
11500239	A18-4-30PC-1000	18mm, 30" Spacing, 1 GPH, 1000'	0.710"	0.620"	41	
11500264	A18-4-36PC-1000	18mm, 36" Spacing, 1 GPH, 1000'	0.710"	0.620"	40	



MICRO DRIP TUBING

JAIN® / PEPCO™ MINI-PEPLINE™ TF MINI-DRIPPERLINE

Part No.	Model No.	Description	O.D.	I.D.	Carton Qty.	Price
11500023	PM0406100	1/4", 6" Spacing, .5 GPH, 100' Black	0.250"	0.170"	20	
11500880	PM0406100B	1/4", 6" Spacing, .5 GPH, 100' Brown	0.250"	0.170"	20	
11500025	PM0412100	1/4", 12" Spacing, .5 GPH, 100' Black	0.250"	0.170"	20	
11500881	PM0412100B	1/4", 12" Spacing, .5 GPH, 100' Brown	0.250"	0.170"	20	

PM0406 MINI-PEPLINE PRECIPITATION RATE FOR GRID PATTERN LAYOUT

Lateral Spacing	Inches / Hour
6"	3.2
9"	2.1
12"	1.6
15"	1.3

PM0412 MINI-PEPLINE PRECIPITATION RATE FOR GRID PATTERN LAYOUT

Lateral Spacing	Inches / Hour
12"	.80
16"	.64
18"	.53
24"	.40
30"	.32
36"	.27



MINI-PEPLINE PRECIPITATION RATES FOR SINGLE LINE LAYOUT (INCHES/HOUR)

Part No.	Sand	Sandy Loam	Loam	Clay Loam	Clay
PM0406	2.4	1.8	1.3	1.1	.9
PM412	1.2	.9	.7	.6	.5

NETAFIM™ STREAMLINE THINWALL DRIPPERLINE

STREAMLINE 630

Wall thickness available in 4, 6, 8, 10 mil. Common dripper spacing at 8, 10, 12, 16, 18, 24 inch.

Part No.	Diameter	Thickness	Spacing	Reel Length	1-63 Reels	64+ Reels
06SLF6638.X-12	5/8"	6 mil	12"	11,500'		
06SLF8636.X-08	5/8"	8 mil	8"	9,000'		
06SLF8636.X-12	5/8"	8 mil	12"	9,000'		
06SLF8636.X-16	5/8"	8 mil	16"	9,000'		
06SLF8636.X-18	5/8"	8 mil	18"	9,000'		
06SLF8636.X-24	5/8"	8 mil	24"	9,000'		



STREAMLINE 875

Wall thickness available in 6, 8, 10 mil. Common dripper spacing at 8, 12, 16, 18 inch.

Part No.	Diameter	Thickness	Spacing	Reel Length	1-63 Reels	64+ Reels
06PYF8.XSL-12	7/8"	8 mil	12"	6,000'		
06PYF10.XSL-12	7/8"	10 mil	12"	5,500'		

Add to Part No. (X)	Emitter Flow Rate (GPH) at 10 PSI	Spacing	Flow Rate (GPM) per 100 Ft. at 10 PSI
16	0.16	12"	0.245
2	0.22	12"	0.364
4	0.38	12"	0.555

NETAFIM™ TYPHOON THINWALL DRIPPERLINE

TYPHOON 630

Wall thickness available in 8, 10, 13, 15 mil. Common dripper spacing at 12, 16, 18, 24, 30 inch.

Part No.	Diameter	Thickness	Spacing	Reel Length	1-63 Reels	64+ Reels
06TSF8636.X-12	5/8"	8 mil	12"	8,000'		
06TSF10636.X-12	5/8"	10 mil	12"	6,500'		
06TSF13636.X-12	5/8"	13 mil	12"	5,000'		
06TSF15636.X-12	5/8"	15 mil	12"	4,100'		



TYPHOON 875

Wall thickness available in 8, 10, 13 mil. Common dripper spacing at 12, 16, 18, 20, 24, 30 inch.

Part No.	Diameter	Thickness	Spacing	Reel Length	1-63 Reels	64+ Reels
06PYF8.X-12	7/8"	8 mil	12"	6,000'		
06PYF10.X-12	7/8"	10 mil	12"	5,500'		
06PYF13.X-20	7/8"	13 mil	20"	4,000'		
06PYF13.X-24	7/8"	13 mil	24"	4,000'		

TYPHOON 990

Wall thickness available in 13 mil. Common dripper spacing at 12, 18, 20, 24, 30 inch.

Part No.	Diameter	Thickness	Spacing	Reel Length	1-63 Reels	64+ Reels
06T990F13.X-20	1"	13 mil	20"	3,000'		
06T990F13.X-24	1"	13 mil	24"	3,000'		

TYPHOON 1-3/8"

Wall thickness available in 15 mil. Common dripper spacing at 14, 20, 24 inch.

Part No.	Diameter	Thickness	Spacing	Reel Length	1-47 Reels	48+ Reels
06TF13815.X-24	1-3/8"	15 mil	24"	2,700'		

EMITTER FLOW DATA

Add to Part No. (X)	Emitter Flow Rate (GPH) at 10 PSI	Spacing	Flow Rate (GPM) per 100 Ft. at 10 PSI
16	0.18	24"	0.137
2	0.24	24"	0.184
4	0.36	24"	0.272
6	0.58	24"	0.444

EURODRIP® SEAMLESS DRIP TAPE

5/8" SEAMLESS DRIP TAPE

Wall thickness available in 6, 8, 10, 12 mil. Common dripper spacing (SP) at 8, 12, 16, 24 inch.

Part No.	Diameter	Thickness	Spacing	Reel Length	1-63 Reels	64+ Reels
P210206-XX-INSP	5/8"	6 mil	8"	9,000'		
P210208-XX-INSP	5/8"	8 mil	8"	7,700'		
P210210-XX-INSP	5/8"	10 mil	8"	6,700'		
P210212-XX-INSP	5/8"	12 mil	8"	5,000'		
P210206-XX-INSP	5/8"	6 mil	12"	9,000'		
P210208-XX-INSP	5/8"	8 mil	12"	7,700'		
P210210-XX-INSP	5/8"	10 mil	12"	6,700'		
P210212-XX-INSP	5/8"	12 mil	12"	5,000'		
P210206-XX-INSP	5/8"	6 mil	16"	9,000'		
P210208-XX-INSP	5/8"	8 mil	16"	7,700'		
P210210-XX-INSP	5/8"	10 mil	16"	6,700'		
P210212-XX-INSP	5/8"	12 mil	16"	5,000'		
P210206-XX-INSP	5/8"	6 mil	24"	9,000'		
P210208-XX-INSP	5/8"	8 mil	24"	7,700'		
P210210-XX-INSP	5/8"	10 mil	24"	6,700'		
P210212-XX-INSP	5/8"	12 mil	24"	5,000'		

XX= Emitter Flow Code SP = Spacing



7/8" SEAMLESS DRIP TAPE

Wall thickness available in 8, 10, 12, 15 mil. Common dripper spacing (SP) at 8, 12, 16, 20, 24 inch.

Part No.	Diameter	Thickness	Spacing	Reel Length	1-63 Reels	64+ Reels
P210608-XX-INSP	7/8"	8 mil	8"	5,700'		
P210610-XX-INSP	7/8"	10 mil	8"	4,700'		
P210612-XX-INSP	7/8"	12 mil	8"	4,200'		
P210615-XX-INSP	7/8"	15 mil	8"	3,600'		
P210608-XX-INSP	7/8"	8 mil	12"	5,700'		
P210610-XX-INSP	7/8"	10 mil	12"	4,700'		
P210612-XX-INSP	7/8"	12 mil	12"	4,200'		
P210615-XX-INSP	7/8"	15 mil	12"	3,600'		
P210608-XX-INSP	7/8"	8 mil	16"	5,700'		
P210610-XX-INSP	7/8"	10 mil	16"	4,700'		
P210612-XX-INSP	7/8"	12 mil	16"	4,200'		
P210615-XX-INSP	7/8"	15 mil	16"	3,600'		
P210608-XX-INSP	7/8"	8 mil	20"	5,700'		
P210610-XX-INSP	7/8"	10 mil	20"	4,700'		
P210612-XX-INSP	7/8"	12 mil	20"	4,200'		
P210615-XX-INSP	7/8"	15 mil	20"	3,600'		
P210608-XX-INSP	7/8"	8 mil	24"	5,700'		
P210610-XX-INSP	7/8"	10 mil	24"	4,700'		
P210612-XX-INSP	7/8"	12 mil	24"	4,200'		
P210615-XX-INSP	7/8"	15 mil	24"	3,600'		

XX= Emitter Flow Code SP = Spacing



EMITTER FLOW DATA

Emitter Flow Code Add to Part No.	Nominal Emitter Flow Rate (GPH)	Emitter Flow Rate (GPH) at 8 PSI	Emitter Flow Rate (GPH) at 10 PSI
XX=07	.16	0.15	0.17
XX=13	.25	0.23	0.26
XX=16	.40	0.31	0.35

BOWSMITH® EMITTERS

NONSTOP® GRIPPER EMITTERS

Model No.	Part No.	Description	Box Qty.	Price
NSG-06	6050	Green, 0.6 GPH @ 20 PSI	1000	
NSG-10	6051	Blue, 1.0 GPH @ 20 PSI	1000	
NSG-20	6053	Red, 2.0 GPH @ 20 PSI	1000	



NONSTOP® SHUR-LOK™ EMITTERS

Model No.	Part No.	Description	Box Qty.	Price
NSS-06	6065	Green, 0.6 GPH @ 20 PSI	1000	
NSS-10	6066	Blue, 1.0 GPH @ 20 PSI	1000	
NSS-20	6067	Red, 2.0 GPH @ 20 PSI	1000	



NONSTOP® VGN EMITTERS W/ CLIP & WIRE HOOK (FOR 1/2" POLY)

Model No.	Part No.	Description	Box Qty.	Price
VGN-06-7	6108	Green, 0.6 GPH @ 20 PSI	2000	
VGN-10-7	6109	Blue, 1.0 GPH @ 20 PSI	2000	
VGN-20-7	6110	Red, 2.0 GPH @ 20 PSI	2000	



NONSTOP® SB SERIES EMITTERS, 0.250 BARB X 0.175 BARB

Model No.	Part No.	Description	Box Qty.	Price
SB-06	6120	Green, 0.6 GPH @ 20 PSI	1000	
SB-10	6121	Blue, 1.0 GPH @ 20 PSI	1000	
SB-20	6123	Red, 2.0 GPH @ 20 PSI	1000	
SB-30	6124	Yellow, 3.0 GPH @ 20 PSI	1000	

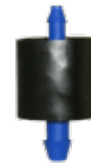

TRU-FLO™ GRIPPER TURBULENT FLOW EMITTERS

Model No.	Part No.	Description	Box Qty.	Price
TFG-05	6090	Green, 0.5 GPH @ 15 PSI	1000	
TFG-10	6091	Blue, 1.0 GPH @ 15 PSI	1000	
TFG-20	6092	Red, 2.0 GPH @ 15 PSI	1000	



TRU-FLO™ SHUR-LOK™ EMITTERS

Model No.	Part No.	Description	Box Qty.	Price
TFS-05	6095	Green, 0.5 GPH @ 15 PSI	1000	
TFS-10	6096	Blue, 1.0 GPH @ 15 PSI	1000	
TFS-20	6097	Red, 2.0 GPH @ 15 PSI	1000	



TRU-FLO™ VG EMITTERS W/ CLIP & WIRE HOOK (FOR 1/2" POLY)

Model No.	Part No.	Description	Box Qty.	Price
VGT-05-7	6100	Green, 0.5 GPH @ 15 PSI	2000	
VGT-10-7	6101	Blue, 1.0 GPH @ 15 PSI	2000	
VGT-20-7	6103	Red, 2.0 GPH @ 15 PSI	2000	



FAN-JET "PC" SERIES PRESSURE COMPENSATORS

Model No.	Part No.	Description	Color	Nominal Flow	Price
PC-4	3229	Barb inlet and outlet Wide regulating range Self-Flushing High clog Resistance	Brown	4.0 GPH	
PC-6	3230		Black	6.0 GPH	
PC-8	3231		Orange	8.0 GPH	
PC-10	3232		Blue	10.0 GPH	
PC-12	3233		Gray	12.0 GPH	
PC-14	3234		Violet	14.0 GPH	
PC-18	3235		Green	16.0 GPH	



TORO® AG EMITTERS

TURBO-KEY® TURBULENT FLOW EMITTERS

Part No.	Description	Bag Qty.	Price
DNK02-3	0.5 GPH @ 15 PSI	200	
DNK04-3	1.0 GPH @ 15 PSI	200	
DNK08-3	2.0 GPH @ 15 PSI	200	



E-2® TAKE APART EMITTERS

Part No.	Description	Bag Qty.	Price
DBK04	1.0 GPH @ 15 PSI	100	
DBK08	2.0 GPH @ 15 PSI	100	
DBK16	4.0 GPH @ 15 PSI	100	



TURBO-SC® PLUS PRESSURE COMPENSATING EMITTERS

Part No.	Description	Bag Qty.	Price
DPJ02-3	0.5 GPH @ 15-50 PSI	200	
DPJ04-3	1.0 GPH @ 10-50 PSI	200	
DPJ08-3	2.0 GPH @ 15-45 PSI	200	



RAIN BIRD® EMITTERS

Self Piercing, use with XM-Tool to Speed Installation.

LADY BUG TURBULENT FLOW EMITTERS

Part No.	Description	Bag Qty.	Price
EM-L05	Blue, 0.5 GPH @ 15 PSI	250	
EM-L10	Black, 1.0 GPH @ 15 PSI	250	
EM-L20	Red, 2.0 GPH @ 15 PSI	250	



RAIN BUG PRESSURE COMPENSATING EMITTERS

Part No.	Description	Bag Qty.	Price
PCEM10SPB	Black, 1.0 GPH @ 15-50 PSI	250	
PCEM20SPB	Red, 2.0 GPH @ 15-50 PSI	250	



NETAFIM™ ON-LINE DRIPPERS

WOODPECKER PRESSURE COMPENSATING JUNIOR DRIPPERS

Part No.	Description	Bag Qty.	Price
01WPCJL2	Red, 0.5 GPH @ 7-50 PSI	250	
01WPCJL4	Gray, 1.0 GPH @ 7-50 PSI	250	
01WPCJL8	Green, 2.0 GPH @ 7-50 PSI	250	



SUBMATIC ORIFICE EMITTERS

E2 AND E4 ORIFICE EMITTERS

Part No.	Description	Bag Qty.	Price
E2	Black, 2 GPH @ 10 PSI	100	
E4	Blue, 4 GPH @ 10 PSI	100	



Use with E-IT Insertion Pliers to speed up installation.

EZ-TRENCH

You can install low voltage lighting, or subsurface tubing quickly and easily with the EZ-Cable Installer. You are actually installing the wire or tubing and backfilling while digging the trench with this machine. The C7 installs the wire or tubing up to 7" deep.



EZ-TRENCH

Part No.	Weight	Rate of Cut	Engine	Wire Install Depth	Price
TP400CL7	150 Lbs	Appx 100' in 5 Min	Gonda GX200 (6.5 Hp)	5", 6", 7"	

DRIP TAPE KIT

DRIP TAPE KIT

Part No.	Base Type	Pack Qty	Price
DTK-10	10 Row Drip Tape Kit	1	

DRIP SYSTEM PARTS LIST

Item	Description	Qty Needed for 100'
1	Drip Tape 1,000' Roll 8 Mil 12" Space, 43 Gph	1
2	Barbed Ball Valve Start Connections	10
3	Drip Tape End Caps	10
4	Drip Tape Repair Couplings (Orange)	10
5	3/4" Poly Supply Tubing	1
6	3/4" Swivel Connector	1
7	3/4" Figure 8	2
8	3/4" Poly Repair Couplings	5
9	Punch Tool	1
10	3/4" Filter	1
11	3/4" 15# Pressure Regulator	1
12	Drip Tape Stakes	25
13	Poly Tubing Tee	1
14	Poly Tubing Goof Plugs	1



ANTELCO® DRIP MATE® DRIP & SPRAY KITS

Part No.	Description	Price
81495	Drip Mate® Drip Kit (Contains Shrubblers®)	
83495	Drip Mate Professional Drip Kit (Contains Shrubblers®)	
82095	Drip Mate® Spray Kit (Contains Spectrum 360°™)	

SYSTEM COMPONENTS INCLUDED

Item	Description
1	50' Mainline Tubing
2	50' of 1/4" Tubing
3	25 Shrubbler® 360° or Spectrum 360°™
4	Snap-on Tap Adapter
5	Snap-on Filter
6	Ratchet Clamp
7	End Caps (2)
8	Goof Plug (10)
9	Key Punch™
10	Elbow
11	Tee



ANTELCO® ADJUSTABLE FLOW & RAIN BIRD® XERI-BUBBLER™ PRODUCTS

Mini Bubbler 360°:

Produces a gentle umbrella pattern for rapid watering near the root zone. Flow to individual plants can be adjusted or shut off.

Shrubbler® 360° and 180°:

When the cap is rotated the flow and radius adjust from a gentle stream pattern, to a drip and finally shut off.

Spectrum 360°™ Jet:

Adjustable full circle vortex spray jet with fine water droplets. Reduce diameter and flow by simply rotating the cap.

MINI BUBBLER, SHRUBBLER® & SPECTRUM 360™ ADJUSTABLE FLOW PRODUCTS

Performance	Pressure (PSI)	Mini Bubbler		Shrubbler®			Spectrum 360°™	
		Flow (GPH)	Diameter (Ft.)	Flow (GPH)	360° (D)'	180° (R)'	Flow (GPH)	Diameter (Ft.)
fully open (approximately 22 clicks)	15	27.0	0.69	8.7	1.2	1.2	17.3	9.4
	20	30.1	1.05	10.3	1.9	1.5	19.8	11.2
	30	35.0	1.89	13.0	3.0	2.0	24.3	13.3

MINI BUBBLER 360° ADJUSTABLE FLOW UMBRELLA PATTERN

Part No.	Base Type	Pack Qty	Price
31745	Barb 0.16"	100	
31715	Threaded 10-32 UNF	100	
31725	Thread 1/2" FIPT	25	
31795	Spike	25	

SHRUBBLER® 360° ADJUSTABLE FLOW STREAM PATTERN

Part No.	Base Type	Pack Qty	Price
31445	Barb 0.16"	100	
31415	Threaded 10-32 UNF	100	
31425	Thread 1/2" FIPT	25	
31495	Spike	25	

SHRUBBLER® 180° ADJUSTABLE FLOW STREAM PATTERN

Part No.	Base Type	Pack Qty	Price
31245	Barb 0.16"	100	
31215	Threaded 10-32 UNF	100	
31225	Thread 1/2" FIPT	25	
31295	Spike	25	

SPECTRUM 360°™ JET ADJUSTABLE FLOW FAN PATTERN

Part No.	Base Type	Pack Qty	Price
32045	Barb 0.16"	50	
32015	Threaded 10-32 UNF	50	
32025	Thread 1/2" FIPT	25	
32095	Spike	25	



BOWSMITH FAN-JET®

BOWSMITH FAN-JET® MICROSPRAYS

High quality, with quick threading bases for strength and fast installation. Available in a wide variety of sizes and patterns. Used in orchards, vineyards, nurseries and landscape beds. Excellent for sandy soils.



Part No.	Description			Bag Qty.	Price
FAN-JET® See below for part numbers. Approximate diameter in feet at 20 PSI listed next. *Configurations not recommended due to runoff.	30 Black	6.0 GPH	@ 20 PSI	1000	
	35 Orange	8.4 GPH	@ 20 PSI	1000	
	40 Blue	10.7 GPH	@ 20 PSI	1000	
	45 Violet	14.1 GPH	@ 20 PSI	1000	
	50 Green	16.7 GPH	@ 20 PSI	1000	
	55 Yellow	20.5 GPH	@ 20 PSI	1000	
	60 Red	24.0 GPH	@ 20 PSI	1000	

		Nozzle							
Pattern	Trajectory	.030 Black	.035 Orange	.040 Blue	.045 Violet	.050 Green	.055 Yellow	.060 Red	
	A High / Low Diameter, Ft.	3800 14/10	3814 18/13	3827 21/16	3840 24/18	3852 26/19	3865 27/20	3875 28/22	
	B High Diameter, Ft.	3801 16	3815 18	3828 20	3841 21	3853 22	3866* 26*	3876* 28*	
	B1 Standard Diameter, Ft.	3920 17	3921 18	3922 21	3923 22	3924 24	3925 27	3926 28	
	C Standard Diameter, Ft.	3802 12	3816 16	3829 19	3842 22	3854 22	3867 27	3877 29	
	D Flat Diameter, Ft.	3803 9	3817 11	3830 13	3843* 14*	3855* 15*	3868* 16*	3878* 17*	
	E Standard Diameter, Ft.	3804 9	3818 11	3831 13	3844 15	3856 15	3869 19	3879 19	
	F Inverted Diameter, Ft.	3805 15	3819 18	3832 21	3845 23	3857 25	3870 27	3880 29	
	G Flat Diameter, Ft.	3902 9	3903 12	3904 13	3905 14	Not Available	Not Available	Not Available	
	H Standard Diameter, Ft.	3806 14	3820 16	3833 17	3896* 18*				
	J2 Standard Diameter, Ft.	3808 9	3821 11	3834 12	3846 14	3859 16	3871* 19*	3882* 19*	
	K Mist Diameter, Ft.	3809 8	3822 8	3835 8	3847 9	3860 9	3872 9	3883 11	
	L High Diameter, Ft.	3810 4	3823 4	3836 5	3848 5	3861 6	3873 7	3884 7	
	N High / Low Diameter, Ft.	3811 16/15	3824 20/16	3837 22/18	3849 25/20	3862 28/23	3889 29/24	3885 31/25	
	P Inverted Diameter, Ft.	3964 8 x 15	3965 9 x 16.5	3966 10 x 18.5	3967 11 x 20.5	3968* 12 x 22*	Not Available	Not Available	
	R Standard Diameter, Ft.	3812 15 x 6	3825 16 x 7	3838 18 x 8	3850 20 x 10	3863 20 x 10	3874 23 x 17	3886 24 x 16	
	U Standard Diameter, Ft.	3901 14	3958 17	3959 19	3960 22	3961 25	3962 26	3963 28	
	V Standard Diameter, Ft.	3971 7 x 11	3972 7.5 x 11.5	3973 8 x 12.5	3974 9 x 14	Not Available	Not Available	Not Available	
	X Standard Diameter, Ft.	3813 17 x 7	3826 19 x 8	3839 21 x 10	3851 22 x 12	3864 24 x 14	3898 25 x 15	3887 27 x 16	

BOWSMITH TOP HAT™

Snaps onto Fan-Jet® head to deflect streams downward which reduces the coverage of the wetted area. The Top Hat™ is used for new plantings and other application areas where the plants root system hasn't developed past the point where a broader wetted area is required. The Top Hat™ is easily removed when a larger wetted area is needed.



Part No.	Description	Price
3146	Top Hat™ Throw Limiter	

BOWSMITH FAN-JET®

FAN-JET® PLUS SPRINKLER HEADS

Part No.	Bag Qty	Price
Fan-Jet Plus	250	



Nozzle Sizes	Spray Pattern			
	A+	B+	J+	U+
30 Black	4001	NA	4030	NA
35 Orange	4002	4011	4031	4041
40 Blue	4003	4012	4032	4042
45 Violet	4004	4013	4033	4043
50 Green	4005	4014	4034	4044
55 Yellow	4006	4015	4035	4045
60 Red	4007	4016	4036	4046
Shaded Areas not recommended				

The Bowsmith Fan-Jet micro-sprinkler combines the quality of the original Fan-Jet micro-sprinkler, plus the added feature that prevents clogging or pattern distortion due to insects and other external objects - saving you time and money.

"SK" SERIES FAN-JET®

Part No.	Feeder Tubing®	Fan-Jet Head	Coupling	SK Stake	Price
8519	24" / PE	Specify by Nozzle Size and Pattern	Specify Standard Barb or Restrictor	Specify "J" or "C" Type	
8520	36" / PE				
8523	48" / PE				
8524	60" / PE				
8521	72" / PE				
8530	24" / Vinyl				
8507	36" / Vinyl				
8534	48" / Vinyl				
8539	60" / Vinyl				
8304	72" / Vinyl				

* Feeder tubing: PE is 0.160" I.D. x 0.245" O.D. / Vinyl is 0.140" I.D. x 0.250" O.D.

"SP" SERIES FAN-JET®

Part No.	Riser* Length	Fan-Jet Head	SP Spike	Price
8655	3" / PE	Specify by Nozzle Size and Pattern	Assembled with Choice of #3018 Thread or #3028 Barb Spike	
8656	6" / PE			

* Riser is 0.158" I.D. x 0.300" O.D.

"TB" SERIES FAN-JET®

Part No.	Riser* Length	Fan-Jet Head	SP Spike	Price
8645	3" / PE	Specify by Nozzle Size and Pattern	Assembled with Choice of 3/8" or 1/2" MPT Base	
8646	6" / PE			

* Riser is 0.158" I.D. x 0.300" O.D.

"DC" SERIES FAN-JET®

Part No.	Drop Tube* Length	Fan-Jet Head	PVC Weighted Sleeve	Barb Coupling	Price
8686	12"	Specify by Nozzle Size and Pattern	Assembled with other Components	Assembled with other Components	

* Drop tube is 0.158" I.D. x 0.300" O.D.



ANTELCO® JET PRODUCTS

ANTELCO® VERI-JETS™

Veri-Jets™ applications include home gardens and landscaping and is ideal for adjusting overhead watering of plants and hanging baskets. Available in four spray patterns, all with 10-32 thread for installation on rigid risers. Valve reduces flow and adjusts radius of throw.



Part No.	Spray Type	Pack Qty.	Price
13115	90° Fan	50	
13125	180° Fan	50	
13145	360° x 18 Hole	50	
13195	Mist	50	

Performance	Pressure (PSI)	JET				MIST	
		Flow (GPH)	360° Dia. of Throw (Ft.)	180° Rad. of Throw (Ft.)	90° Rad. of Throw (Ft.)	Flow (GPH)	360° Dia. of Throw (Ft.)
Valve Fully Open	15	0 - 21.0	0 - 22.6	0 - 8.1	0 - 8.1	0 - 5.0	0 - 2.6
	20	0 - 24.5	0 - 25.7	0 - 9.5	0 - 9.4	0 - 5.9	0 - 2.9
	25	0 - 28.0	0 - 26.7	0 - 10.1	0 - 9.8	0 - 6.6	0 - 2.8
	30	0 - 31.0	0 - 26.3	0 - 10.6	0 - 10.3	0 - 7.4	0 - 2.6

OLSON JET PRODUCTS

OLSON O-JET® FAN TYPE SPRAY JET - 10-32 THREAD

The O-Jet features low cost, simple one piece molded construction & industry standard color coding for ease in identifying nozzle size.

Part No.	Color	GPH	PSI	Bag Qty.	Price	
See Below For Part Numbers	Black	6.0	20	500		
	Blue	10.4	20	500		
	Green	16.7	20	500		
	Yellow	20.4	20	500		
	Red	24.0	20	500		
Part number listed first, approximate diameter (in feet at 20 PSI) listed next.						
Pattern	Trajectory	Nozzle				
		.030 Black	.040 Blue	.050 Green	.055 Yellow	.060 Red
300°	20°	OL-6013	OL-6023	OL-6033	OL-6083	OL-6043
Diameter, Ft.		8	10	12	13	14
180°	20°	OL-6012	OL-6022	OL-6032	OL-6082	OL-6042
Diameter, Ft.		8	10	14	15	15
90°	35°	OL-6014	OL-6024	OL-6034	OL-6084	OL-6044
Diameter, Ft.		9	12.5	16	16	22



MICRO SPRINKLER PRODUCTS

RAIN BIRD® MICRO-BIRD® II SPRINKLER (TWO STEP THREAD)

Part No.	Color	Orifice Size	Base Type	Flow (GPH) @ PSI			Bag Qty.	Price
				15	20	25		
SP12-340	Blue	0.039"	5/16" x 32 or 3/16" x 32	10.1	11.6	12.9	200	
SP16-340	Green	0.048"		15.1	17.4	19.4	200	
SP24-340	Red	0.057"		20.9	24.1	26.9	200	
SP30-340	Orange	0.068"		28.9	33.4	37.2	200	



ANTELCO® ROTOR SPRAY™

Part No.	Color	Orifice Size	Base Type	Flow (GPH) @ PSI				Price
				15	20	25	30	
20025	Brown	0.035"	10-32 UNF	8.1	9.4	10.5	---	
20015	Blue	0.040"	10-32 UNF	9.8	11.7	13.0	---	
20035	Green	0.050"	10-32 UNF	16.8	19.5	22.0	24.0	
20055	Red	0.060"	10-32 UNF	22.5	26.5	30.0	33.0	
20075	Orange	0.070"	10-32 UNF	27.0	31.5	35.5	39.0	
20045	Gray	0.080"	10-32 UNF	32.5	39.0	43.5	48.0	



ANTELCO® ROTOR RAIN™

Part No.	Color	Orifice Size	Base Type	Flow (GPH) @ PSI				Price
				15	20	25	30	
20535	Green	0.055"	1/2" MIPT	20.0	23.5	26.5	29.2	
20515	Blue	0.070"	1/2" MIPT	26.5	31.0	35.0	38.5	
20545	Gray	0.075"	1/2" MIPT	32.5	38.5	44.0	49.0	
20595	Yellow	0.080"	1/2" MIPT	40.0	47.0	53.0	58.5	
20585	Olive	0.085"	1/2" MIPT	44.0	51.0	58.0	63.5	
20555	Red	0.095"	1/2" MIPT	52.5	61.0	69.0	76.0	
20575	Orange	0.100"	1/2" MIPT	63.5	75.0	85.0	94.5	
20565	Purple	0.110"	1/2" MIPT	70.5	83.0	94.5	105.0	



TORO® AG MICRO-SPRINKLER® VI CLASSIC

Part No.	Color	Orifice Size	Base Type	Flow (GPH) @ PSI			Bag Qty.	Price
				15	20	25		
SAM610	Black	0.034"	3/8" MIPT	7.9	9.1	10.2	50	
SAM613	White	0.041"	3/8" MIPT	11.8	13.7	15.3	50	
SAM614	Maroon	0.049"	3/8" MIPT	16.5	19.0	21.2	50	
SAM616	Green	0.055"	3/8" MIPT	21.5	24.8	27.8	50	
SAM620	Blue	0.065"	3/8" MIPT	29.2	33.7	37.7	50	
SAM622	Gray	0.071"	3/8" MIPT	33.8	39.0	43.6	50	
SAM624	Yellow	0.079"	3/8" MIPT	41.7	48.1	53.8	50	
SAM628	Red	0.091"	3/8" MIPT	56.4	65.1	72.8	50	



NETAFIM™ MEGANET™ ROTATING IMPACT SPRINKLER

Part No.	Model No.	Nozzle Color	Nominal Flow	Trajectory	Base Type	Flow (GPH) @ PSI			Price
						15	20	25	
63600-001700	MGN24D-088HO	Yellow	0.88 GPM	High - 24°	1/2" MIPT	37	42	47	
63600-001750	MGN24D-110HO	Purple	1.10 GPM		1/2" MIPT	45	52	58	
63600-001000	MGN24D-154HO	Green	1.54 GPM		1/2" MIPT	63	72	81	
63600-002000	MGN24D-198HO	Blue	1.98 GPM		1/2" MIPT	80	92	103	
63600-003000	MGN24D-242HO	Brown	2.42 GPM		1/2" MIPT	95	110	123	
63600-004000	MGN24D-286HO	Orange	2.86 GPM		1/2" MIPT	117	135	151	
63600-004500	MGN24D-330HO	Red	3.30 GPM		1/2" MIPT	135	156	175	
63600-004900	MGN15D-088HO	Yellow	0.88 GPM	Low - 15°	1/2" MIPT	37	42	47	
63600-004950	MGN15D-110HO	Purple	1.10 GPM		1/2" MIPT	45	52	58	
63600-005000	MGN15D-154HO	Green	1.54 GPM		1/2" MIPT	63	72	81	
63600-006000	MGN15D-198HO	Blue	1.98 GPM		1/2" MIPT	80	92	103	
63600-007000	MGN15D-242HO	Brown	2.42 GPM		1/2" MIPT	95	110	123	
63600-008000	MGN15D-286HO	Orange	2.86 GPM		1/2" MIPT	117	135	151	



MICRO SPRINKLER PRODUCTS

NETAFIM™ SUPERNET JR. ROTATING IMPACT SPRINKLER

		Model No. (Sprinkler Head Only)	Color Code	Nozzle Color	Nozzle Size	Flow (GPH) @ PSI			Purple Swivel		Black Swivel		Blue Swivel		Max Stream Height*		Price
						15	20	25	LR	LRD	LR	LRD	SR	SRD	LR	SR	
Filtration Recommended	120 Mesh	032210280000E	#28	Brown	.030"	5.6	6.4	7.2	13.1'	4.9'	-	-	14.8'	4.3'	24"	8"	
		032210400000E	#40	Blue	.035"	8.2	9.5	10.6	18.0'	4.9'	-	-	14.8'	4.3'	31"	10"	
		032210580000E	#58	Gray	.043"	12.0	13.8	15.4	-	-	23.0'	4.9'	16.4'	4.3'	33"	12"	
	80 Mesh	032210700000E	#70	Black	.047"	14.4	16.7	18.6	-	-	23.0'	6.6'	18.0'	4.3'	35"	14"	
		032210900000E	#90	Orange	.055"	18.5	21.4	23.9	-	-	23.0'	6.6'	19.7'	4.3'	35"	16"	
		032211200000E	#120	Red	.063"	24.7	28.6	31.9	-	-	26.2'	6.6'	21.3'	4.3'	43"	16"	
		032211500000E	#150	Sky Blue	.071"	30.9	35.7	39.9	-	-	27.9'	-	23.0'	8.2'	47"	16"	

Note: LR= Long Range, LRD = Long Range with Stream Deflector, SR= Short Range, SRD = Short Range with Stream Deflector



NETAFIM™ SUPERNET JR ACCESSORIES

Part No.	Model No.	Nozzle Color	Price
63520-005800	031735	Stream Splitter	
65080-001000	03175624	24" Steel Stake	
65080-001220	03175648	48" Steel Stake	
64020-002000	03173700	Poly Adapter	

NELSON R5 POP UP ROTATOR® PRODUCTS

R5 POP-UP PLATES

Model No.	Color	Description	Nozzle Options - XX					Price
11261-1XX	Green	High Pressure upright mount Radius 12 - 18'	#35 Orange	#40 Blue	#45 Purple	#50 Green	#55 Yellow	
11261-2XX	Wine	Inverted mount Radius 7 - 14'	#35 Orange	#40 Blue	#45 Purple	#50 Green		
11261-3XX	Blue	Low Pressure upright mount Radius 10 - 16'	#35 Orange	#40 Blue	#45 Purple	#50 Green	#55 Yellow	



NOZZLES

Description			Price
35 Orange	8.5 GPH	@ 20 PSI	
40 Blue	10.8 GPH	@ 20 PSI	
45 Purple	13.7 GPH	@ 20 PSI	
50 Green	16.8 GPH	@ 20 PSI	
55 Yellow	20.3 GPH	@ 20 PSI	

NELSON R5 ROTATOR® PRODUCTS

The R5 Rotator® is a completely different micro sprinkler, with a unique and patented drive principle. The water stream emitting from the nozzle is directed into an offset channel on the rotor plate, creating a reactionary drive force. A viscous silicone fluid in the rotor motor controls the rotation speed. Rotator® technology gives the R5 high uniformity and a distance of throw greater than that of any other micro sprinkler.



The R5 Rotator® is available with either a standard or flow control nozzle. The flow control nozzle option for the R5 Rotator® features a flow control nozzle that regulates flow starting as low as 15 PSI. Commonly used micro sprinklers with pressure compensation are not recommended for use under 20 PSI. Flow Control Nozzles deliver more accurate flow regulation at lower pressures. Further, they assure uniform application of water throughout the crop.

Always use the recommended pressure for a given plate and nozzle combination. The absence of flow data on the chart below for a particular plate / nozzle combination indicates the pressure is outside the recommended range. Filtration is suggested to be 75 mesh or finer. The plate and nozzle of the R5 should not be removed when cleaning plugged nozzles. Any attempt to do so will likely cause permanent damage. Please give us a call if you have any questions pertaining to the R5.

PLATE / NOZZLE OPTIONS AND FLOW PERFORMANCE IN GPH

Plate Options	Part No.	Recommended Nozzles	PSI					
			15	20	25	30	35	40
<ul style="list-style-type: none"> • Green-Upright Mount • High Pressure Model • Shaded combinations not recommended • Radius 14-17 Ft. 	9836-135	#35 Orange				10.5	11.4	12.1
	9836-140	#40 Blue			12.2	13.3	14.4	15.5
	9836-145	#45 Purple			15.4	16.8	18.2	19.6
	9836-150	#50 Green			18.8	20.6	22.3	23.9
	9836-155	#55 Yellow			22.8	25	27	29
<ul style="list-style-type: none"> • Wine-Inverted Mount • Shaded combinations not recommended • Radius 11-15 Ft. 	9836-235	#35 Orange			9.5	10.5	11.4	12.1
	9836-240	#40 Blue		10.8	12.2	13.3	14.4	15.5
	9836-245	#45 Purple	11.7	13.7	15.4	16.8	18.2	19.6
	9836-250	#50 Green	14.3	16.8	18.8	20.6		
<ul style="list-style-type: none"> • Blue-Upright Mount • Low Pressure Model • Shaded combinations not recommended • Radius 11-16 Ft. 	9836-335	#35 Orange		8.5	9.5	10.5		
	9836-340	#40 Blue	9.3	10.8	12.2	13.3		
	9836-345	#45 Purple	11.7	13.7	15.4	16.8		
	9836-350	#50 Green	14.3	16.8	18.8	20.6		
	9836-355	#55 Yellow	17.4	20.3	22.8			



R5FCN PART NUMBER AND PRESSURE RANGE IN PSI

R5FCN Nozzle Options	Green Plate Part No.	PSI Range	Wine Plate Part No.	PSI Range	Blue Plate Part No.	PSI Range
8.5 GPH Orange	9836-109	-	9836-209	20-45	9836-309	20-40
11 GPH Blue	9836-111	25-45	9836-211	15-45	9836-311	15-40
14 GPH Purple	9836-114	25-45	9836-214	15-45	9836-314	15-35
18 GPH Yellow	9836-118	25-45	9836-218	15-30	9836-318	15-30
24 GPH Red	9836-124	25-45	9836-224	15-25	9836-324	15-30

R5 ROTATOR®

Part No.	Description	Price
Refer to Top Table	R5 Rotator® Including Plate & Standard Nozzle	
Refer to Lower Table	R5 Rotator® Including Plate & Flow Control Nozzle	

NELSON R5 ROTATOR® FEEDTUBE ASSEMBLIES & ACCESSORIES

Nelson Rotator® Feedtube Assemblies

These versatile stake mounting options feature durable stakes, UV and kink resistant flexible PVC tubing for fast simple installation. Please contact us if you have any questions in regard to these mounting options or any of the following R5 Rotator® accessories.

FT-01 FEEDTUBE ASSEMBLY FOR THE R5 (UPRIGHT MOUNT)

Part No.	Description	Price
10847	Stake 12"	
10848	Stake 17-1/2"	
9960-924	24" Tube with Barb	
9960-930*	30" 4MM Flexible PVC Feedtube & LTO, 4MM Barb Assembly	
9960-936	36" Tube with Barb	
10745-024	12" Stake & 24" Tube with Barb - Assembled	
10745-036	12" Stake & 36" Tube with Barb - Assembled	
10744-036	17-1/2" Stake & 36" Tube with Barb - Assembled	

* 30" Feedtube not available as stake assembly

FT-02 FEEDTUBE ASSEMBLY* FOR THE R5 (INVERTED MOUNT)

Part No.	Description	Price
10136	R5 Rod Stake Adapter	
9987	Hanger Rod Clip (2 are Required)	
9960-930	30" Tube with Barb	
9960-948	48" 4MM Flexible PVC Feed Tube & LTO, 4MM Barb Assembly	
10040-024	24" 6.3MM Fiberglass Plastic Rod Stake	
9726-024	24" 6.3MM Steel Rod Stake	
9982-148	48" 4.7MM Steel Rod Stake	

* For complete assembly order adapter, 2 clips, feedtube & stake

FT-03 FEEDTUBE ASSEMBLY* FOR THE R5 (UPRIGHT MOUNT)

Part No.	Description	Price
10136	R5 Rod Stake Adapter	
9960-924	24" 4MM Flexible PVC Feedtube & LTO, 4MM Barb Assembly	
9960-930	30" 4MM Flexible PVC Feedtube & LTO, 4MM Barb Assembly	
9960-936	36" 4MM Flexible PVC Feedtube & LTO, 4MM Barb Assembly	
10040-018	18" 6.3MM Fiberglass Plastic Rod Stake	
10040-024	24" 6.3MM Fiberglass Plastic Rod Stake	
9982-124	24" 4.7MM Steel Rod Stake	

* For complete assembly order adapter, feedtube & stake

1/2 PVC-4 FEEDTUBE ASSEMBLY* FOR THE R5

Part No.	Description	Price
10081-002	Tubing, 4MM Flexible - 1000' (305M) Coil	
11258	Adapter Assembly, PV-4, Gray, 4MM Tubing	
9960-924	24" 4MM Flexible PVC Feedtube & LTO, 4MM Barb Assembly	
9960-930	30" 4MM Flexible PVC Feedtube & LTO, 4MM Barb Assembly	
9960-936	36" 4MM Flexible PVC Feedtube & LTO, 4MM Barb Assembly	
9960-948	48" 4MM Flexible PVC Feedtube & LTO, 4MM Barb Assembly	
11259-209	Stake, PVC, 1/2" x 9" Long Sch. 40	
11259-212	Stake, PVC, 1/2" x 12" Long Sch. 40	
11259-215	Stake, PVC, 1/2" x 15" Long Sch. 40	
11259-221	Stake, PVC, 1/2" x 21" Long Sch. 40	

* For complete assembly order adapter, feedtube & stake

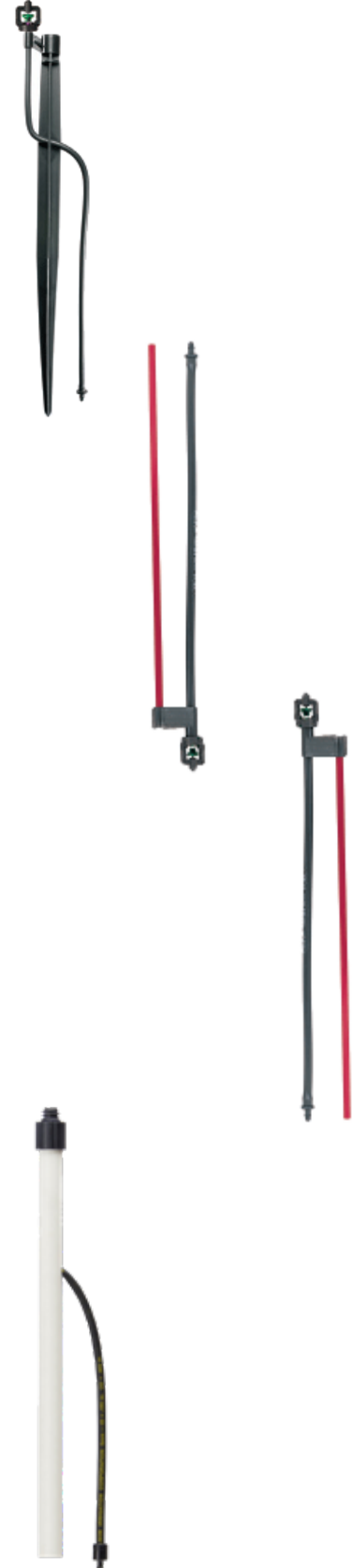

NELSON R5 ROTATOR® FEEDTUBE ASSEMBLIES & ACCESSORIES

PVC ADAPTER FOR R5 MOUNTING

Part No.	Description	Price
10352	PVC Adapter for R5 Mounting	
10615	Threaded Cap For Acme Adapter	
10616	R5 Female Acme x R5 Adapter	
10060-001	Male Acme x 1/2" PVC Socket Adapter	
10060-002	Male Acme x 3/4" PVC Socket Adapter	
10367	Pressure Gauge Tap Assembly	
8968-002	Pressure Gauge 0-60 PSI	
8968-003	Pressure Gauge 0-100 PSI	
8968-004	Pressure Gauge 0-160 PSI	



STREAM SPLITTERS & DEFLECTOR CAP FOR THE R5

Part No.	Description	Price
10746	Single Sided Stream Splitter for Next to Tree	
10976	Two Sided Stream Splitter for Between Trees	
10951	Deflector Cap to Reduce Radius to 2-3 Feet	



ACCESSORIES FOR THE R5

Part No.	Description	Price
9986	PLUG, GOOF, DUAL	
10997	Green Hand Punch Tool, 4MM	
10287	FT-03 Stake Installation Tool, 6.3MM Stake	
10081-002	4MM Flexible PVC Feedtube, 1000 Ft. Coil	
10080	4MM Lateral Take Off (LTO) Barbed Coupling	
11108	Installation Tool - R5	



5MM FEEDTUBE OPTIONS FOR THE R5 & R10

FT2 FEEDTUBE ASSEMBLY FOR THE R10

Part No.	Description	Price
9677	Steel Rod Stake Adapter Acme	
9284-030	5MM x 30" (76cm) Flexible PVC Feedtube	
9284-042	5MM x 42" (107cm) Flexible PVC Feedtube	
9305	LTO, 5MM Compression x 5MM Barb	
9741-030	FT2 Total with 30" Tube - Total Assembled (stake not included)	
9741-042	FT2 Total with 42" Tube - Total Assembled (stake not included)	
9726-024	6.3MM Steel Rod Stake 24" (61cm)	
10040-018	6.3MM Fiberglass Plastic Rod Stake 18" (45cm)	
10040-024	6.3MM Fiberglass Plastic Rod Stake 24" (61cm)	

TOOLS & PARTS FOR 5MM ASSEMBLIES

Part No.	Description	Price
9284	5MM Feedtube, 1000' (305 M) Coil	
10287	Stake Installation Tool for the 6.3MM Stake	
9349	FT2 & 3/4" PVC-5 Hand Punch Tool, 5MM (Red)	
9835-003	FT2 & 3/4" PVC-5 Drill Punch Tool, 5MM	
9986	FT2 & 3/4" PVC-5 Dual Goof Plug (Order in 20's)	
9195	Converts FT2, FT4, & FT5 to 3/4" PVC Stake	

1/2" PVC-5 FEEDTUBE ASSEMBLY FOR THE R5 & R10 (#40-60, .35 & .5 FCN)

Part No.	Description	Price
11271	PVC Stake Adapter (Black) - 5MM	
11283-030	5MM x 30" (76cm) Flexible PVC Feedtube & 9305 LTO	
11284-22130	1/2" PVC Stake 21" (53cm) - hole 9.5" from top, PVC Stake Adapter, 5MM x 30" (76cm) Tube w/ Barb (Assy)	
11284-22142	1/2" PVC Stake 21" (53cm) - hole 9.5" from top, PVC Stake Adapter, 5MM x 42" (107cm) Tube w/ Barb (Assy)	
11284-32130	1/2" PVC Stake 21" (53cm) - hole 1.5" from top, PVC Stake Adapter, 5MM x 30" (76cm) Tube w/ Barb (Assy)	

3/4" PVC-5 FEEDTUBE ASSEMBLY FOR THE R5 & R10

Part No.	Description	Price
11429	3/4" PVC Stake Adapter - 5MM Compression x Male Acme	
9284-030	5MM x 30" (76cm) Flexible PVC Feedtube	
9305	LTO, 5MM Compression x 5MM Barb	
11455-12130	3/4" PVC Stake 21" (53cm) - hole 10" from top, PVC Stake Adapter, 5MM x 30" (76cm) Tube w/ Barb (Assy)	

FT1 REPAIR PARTS

Part No.	Description	Price
9262	FT1 Collar Adapter 3/8" FNPT	
9284-30	5MM x 30" (76cm) Flexible PVC Feedtube	
9305	LTO, 5MM Compression x 5MM Barb	
11283-030	5MM x 30" Flexible PVC Feedtube & 9305 LTO	

FOGGERS

TORO® AG BARBED FOGGERS

Part No.	Description	Bag Qty.	Price
SFJ408	1.9 GPH Barbed Fogger	100	
SFJ412	3.0 GPH Barbed Fogger	100	
SFJ416	3.9 GPH Barbed Fogger	100	

TORO® AG THREADED FOGGERS

Part No.	Description	Bag Qty.	Price
SFL408	1.9 GPH Fogger, 1/8" MIPT	100	
SFL412	3.0 GPH Fogger, 1/8" MIPT	100	
SFL416	3.9 GPH Fogger, 1/8" MIPT	100	

TORO® AG THREADED FOGGER WITH STAKE (BARB)

Part No.	Description	Bag Qty.	Price
SFL4081	1.9 GPH Threaded Fogger with Stake	100	
SFL4121	3.0 GPH Threaded Fogger with Stake	100	
SFL4161	3.9 GPH Threaded Fogger with Stake	100	



MISTERS

MISTING NOZZLE

Part No.	Description	Price
CS301AF0.7-80	Light Gray, 80° Spray Angle, .72 GPH* 1/8" MIPT	
CS301AF1.6-100	Royal Blue, 100° Spray Angle, 1.68 GPH* 1/8" MIPT	

*Performance @ 40 PSI



TEE-JET® MISTER

Part No.	Description	Price
TEEJETPLASTIC	Quick TeeJet Nozzle with Check Valve, 1/4" MPT, Plastic	
TEEJETBRASS	Quick TeeJet Nozzle with Check Valve, 1/4" MPT, Brass	



NURSERY SPRAY STICKS

Used for watering individual pots in Greenhouses and Nurseries.

SWISH STIK™

Part No.	Description	Bag Qty.	Price / Bag
SS-2	SWISH STIK™, Dual Purpose, Single Groove 4.8 GPH, Double Groove 8.4 GPH	100	

Use with 3/16" (0.125" I.D.) SWISH STIK™ Tube. Sold in bags of 100 only. Flow shown @ 20 PSI.

SPOT SPITTER®

Part No.	Description	Bag Qty.	Price / Bag
SS-AG160BLK-100	High Flow Black, 160°, 15.0 GPH	100	
SS-AG160DGN-100	Med. Flow Dark Green, 160°, 11.4 GPH	100	
SS-AG160LGN-100	Low Flow Light Green, 160°, 6.6 GPH	100	
SS-AG160ORG-100	Mini Flow Orange, 160°, 4.2 GPH	100	
SS-AG90BRN-100	Low Flow Brown, 90°, 6.6 GPH	100	
SS-AG90GRY-100	Mini Flow Gray, 90°, 3.0 GPH	100	
SS-AG360BLU-100	Med. Flow Blue, 360°, 10.8 GPH	100	

Use with 3/16" (0.125" I.D.) SWISH STIK™ Tube. Sold in bags of 100 only. Flow shown @ 20 PSI.

NDS TRI-FLO™ SPRAY STICK

Part No.	Description	Bag Qty.	Price / Bag
TFS9	Blue, 90°, 10.6 GPH	100	
TFS16	Green, 160°, 15.9 GPH	100	

Use with 3/16" (0.125" I.D.) SWISH STIK™ Tube. Flow shown @ 20 PSI using high flow node.

SENNINGER® SPRAY STAKES

Part No.	Description	Box Qty.	Price / Bag
SPRST040	Spray Stake, Black, 90°, 4 GPH	1500	
SPRST080	Spray Stake, Brown, 120°, 8 GPH	1500	
SPRST120	Spray Stake, Green, 160°, 12 GPH	1500	

Use with 3/16" (0.125" I.D.) SWISH STIK™ Tube. Sold in boxes of 1500 only. Flow shown @ 20 PSI.

BOWSMITH® JETSTAKE

Part No.	Description	Bag Qty.	Price / Bag
1081	Jet Stake, 5.2 GPH @ 20 PSI (Brown)	100	
1082	Jet Stake, 6.0 GPH @ 20 PSI (Black)	100	
1083	Jet Stake, 8.4 GPH @ 20 PSI (Orange)	100	

Use .220" x .160" P.E. Micro Tube.

JAIN® API® ACU-SPRAY STICK™ PRESSURE COMPENSATING

Part No.	Description	Bag Qty.	Price / Bag
12500952	FCSS-6, 6 GPH, 15" Radius, 180° Spray, Blue w/ Shut Off Hole	50	
12500953	FCSS-8, 8 GPH, 18" Radius, 180° Spray, Brown w/ Shut Off Hole	50	
12500611	FCSS-10, 10 GPH, 22" Radius, 180° Spray, Violet w/ Shut Off Hole	50	
12500612	FCSS-12, 12 GPH, 25" Radius, 180° Spray, Green w/ Shut Off Hole	50	
12500950	FCSS-16, 16 GPH, 30" Rad., 180° Spray, Yellow w/ Shut Off Hole	50	

Flow shown @ 10 PSI.



NURSERY SPRAY STICKS

Used for watering individual pots in Greenhouses and Nurseries.

NETAFIM™ SPRAY STAKE

Part No.	Description	Bag Qty	Price
22500-001030	Yellow Stake, 3.0 GPH Non-Pressure Compensating	100	
22500-001120	Green Stake, 5.0 GPH Non-Pressure Compensating	100	
22500-001220	Black Stake, 7.0 GPH Non-Pressure Compensating	100	

NURSERY GROOVE POT SPRAY STAKES

Part No.	Description	Bag Qty	Price
MSONGST	Rust, 4.2 GPH @ 20 PSI	100	
MSLNGST	Lime Green, 6.6 GPH @ 20 PSI	100	
MSGNGSTST	Green, 11.4 GPH @ 20 PSI	100	
MSBNGST	Black, 15.0 GPH @ 20 PSI		

NETAFIM™ DRIPPER STAKE ASSEMBLIES

.5 GPH Pressure Compensating with CNL Check Valve Feature
Standard with Super Flex UV White PE Tubing

Part No.	Description	Price
40201-020600	Complete Assembly with 24" Tube Length	
40201-020700	Complete Assembly with 30" Tube Length	
40201-021000	Complete Assembly with 36" Tube Length	
40001-002500	UVR White PE Tube Only, 5mm OD x 3mm ID x 1000 Ft.	
40510-000100	UVR White PE Tube Only, 16mm x 500 Ft.	
40510-000105	UVR White PE Tube Only, 3/4 x 500 Ft.	

Note: 1.0 and 2.0 GPH also available

ANTELCO CFD® DOWNSPRAY

Part No.	Description	Price
19005	Black .032" Orifice CFd Downspray Only	
19025	Brown .035" Orifice CFd Downspray Only	
19015	Blue .039" Orifice CFd Downspray Only	
54305	Black CFd Downspray w/ Galvanized Wire Stake Assembly	
54325	Brown CFd Downspray w/ Galvanized Wire Stake Assembly	
54315	Blue CFd Downspray w/ Galvanized Wire Stake Assembly	

MAXI JET MAX-DOUBLE DOWN STREAM

Part No.	Description	Price
RGB360BU36R1	Complete Assembly, Nursery Clip & 12" Rod	
MAU36R1	Blue 3-4 Ft. Diameter @ 20 PSI	
MYO	Orange Nursery Clip	
MROD12	12" Rod Stake	
MOB	Orange Vinyl Collar (Lock Jet Threads into Vinyl)	
MJBBXB9	.195" Barb x 195" Barb Extension Adapter	
MVU36	36" Blue Vinyl Precut Tubing	
MVU500B	500' Blue Vinyl Tubing	

JAIN® (CHAPIN) MICRO TUBE & SPRAY TUBE

Part No.	Description	Bag Qty.	Price
12770X18	Standard Tube Weight w/ 18" 128x0XX-PE Tubing	100	
12770X36	Standard Tube Weight w/ 36" 128x0XX-PE Tubing	100	
12770X48	Standard Tube Weight w/ 48" 128x0XX-PE Tubing	100	
12771X18	On/Off Tube Weight w/ 18" 128x0XX-PE Tubing	100	
12771X36	On/Off Tube Weight w/ 36" 128x0XX-PE Tubing	100	
12771X72	On/Off Tube Weight w/ 72" 128x0XX-PE Tubing	100	
12781324	"P" Spray Tube Stake w/ 24" 128x076-PE Tubing - For Pots	100	
12783436	"N" Spray Tube Stake w/ 36" 187x125-PE Tubing - For Containers	100	

X - Use with .128 O.D. x .036, .050, .060, .076 I.D. Micro Tube.

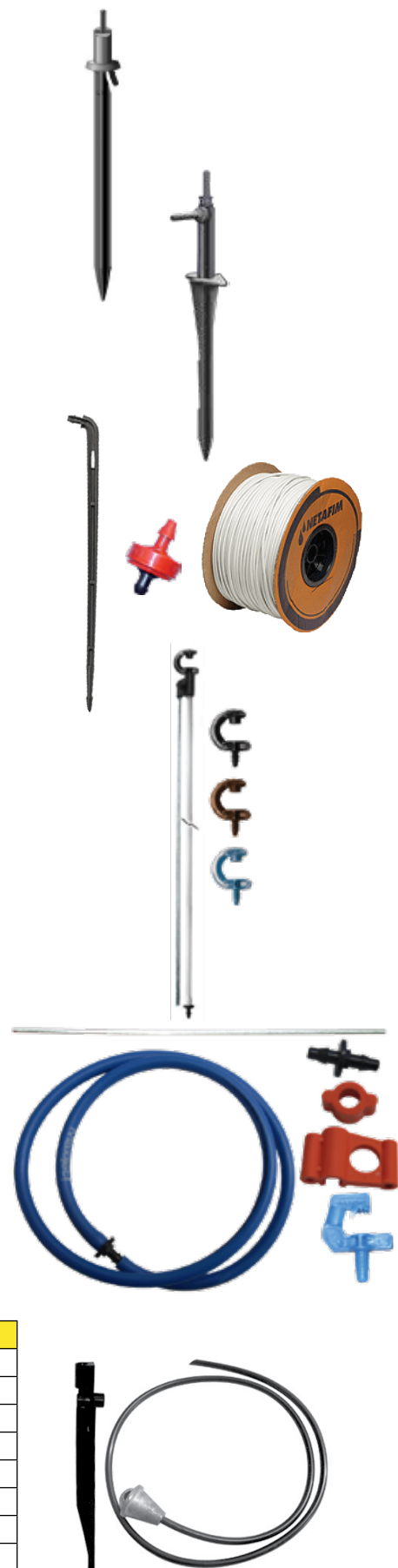

NELSON MINI PRESSURE REGULATORS & DRAIN CHECKS



Mini Regulator Drain Check (MRDC)

Ensure high uniformity and even flow throughout your system and eliminate the effects of pressure gains and losses due to uneven topography or high friction loss. The drain check feature eliminates sprinkler drizzle during shut down and start up. Choose from 20, 30, 35, 40, 45, 50 or 60 PSI (1.4, 2.1, 2.4, 2.8, 3.1, 3.4 or 4.1 BAR) nominal pressures.

Mini Regulator (MR)

For systems in which pressure ranges are excessive, the Nelson Mini Regulator provides uniform flow and distribution at each sprinkler through pressure regulation. Ensure high uniformity and even flow throughout your system and eliminate the effects of pressure gains and losses due to uneven topography or high friction loss. Choose from 20, 30, 35, 40, 45, 50 or 60 PSI (1.4, 2.1, 2.4, 2.8, 3.1, 3.4 or 4.1 BAR) nominal pressures.

Mini Drain Check (MDC)

The MDC is a check valve only that opens 2-5 PSI (.14-.35 BAR) below the nominal pressure rating. Available in 20 and 35 PSI (1.4-2.4 BAR) options. Ideal when a check feature only is needed or when it is necessary to operate sprinklers at different pressures that best suit environmental conditions. Perfect for overhead cooling of apples and other crops. The MDC prevents draining of the system in between frequent on / off cooling cycles.

NELSON MINI REGULATOR DRAIN CHECK

Part No.	Price
Mini Regulator Drain Check Brown	
Mini Regulator Gray	
Mini Drain Check Green	

Eliminate sprinkler drainage during shut down and start up with the Nelson Mini Regulator Drain Check. It is available in the same pressure options as the Mini Regulator.

For Mini Regulator Drain Check (MRDC) and Mini Regulator (MR) specify pressure: 20, 30, 35, 40, 45, 50 or 60 PSI nominal pressures and specify connection. The MDC is a check valve that only opens 2-5PSI below the nominal pressure rating. Available 20 and 35 PSI.

**1/2" FNPT INLET X
1/2" MNPT OUTLET**

Model	Part No.
MRDC	11150-0XX
MR	11146-0XX
MDC	11154-020 or 035



**1/2" MNPT INLET X
1/2" MNPT OUTLET**

Model	Part No.
MRDC	11152-0XX
MR	11148-0XX
MDC	11156-020 or 035



**ACME INLET X
ACME OUTLET**

Model	Part No.
MRDC	10407-0XX
MR	10099-0XX
MDC	11139-020 or 035



**1/2" FNPT INLET X
ACME OUTLET**

Model	Part No.
MRDC	10406-0XX
MR	10020-0XX
MDC	11140-020 or 035



**1/2" MNPT INLET X
ACME OUTLET**

Model	Part No.
MRDC	11153-0XX
MR	11149-0XX
MDC	11157-020 or 035



PRESSURE REGULATORS



NELSON PRESSURE REGULATORS

Part No.	Description	Flow Range (GPM)	Price
9491-XXX	Blue Top/Gray Lo-Flo 3/4" FIPT	.5 - 10/12	
9561-XXX	Blue Top/Gray Lo-Flo FHT x MHT	.5 - 10/12	
9071-XXX	Blue Top/Black Hi-Flo 3/4" FIPT	2 - 16/20	

XXX - 10, 15, 20, 25, 30, 40, 50 PSI



SENNINGER® PRESSURE REGULATORS

Part No.	Description	Flow Range (GPM)	Price
PRL-##	3/4" FIPT Low Flow	1/2 - 5 & 1/10 - 8	
PMR-##MF	3/4" FIPT Medium Flow	4 - 16 & 2 - 20	
PR-##HF	1-1/4" FIPT x 1" FIPT High Flow	10 - 32	
PRXF-##	3" Socket x Socket	20 - 80/85/90/95/100	
## - 6, 10, 12, 15, 20, 25, 30, 35, 40, 50, 60 PSI			
PRLG-##	"3/4 FHT X 3/4 MHT"	0.1 - 7	
## - 10, 15, 20, 25, 30, 35, 40 PSI			



NETAFIM™ PRESSURE REGULATORS

Part No.	Description	Flow Range (GPM)	Price
32PRV.75-LF##V2	3/4" FIPT x 3/4" FIPT	0.25 - 4.4	
32PRV.75-##V2K	3/4" FIPT x 3/4" MIPT	5.50 - 17.6	
32PRV1.5-##V2K	1-1/2" MIPT x 1-1/2" MIPT	11.00 - 35.0	
32PRV2-4##V2K	2" FIPT x 2" FIPT	22.00 - 70.0	
32PRV2-6##V2K	2" FIPT x 2" FIPT	33.00 - 105.6	
32PRV3-10##V2K	3" FIPT x 3" FIPT	55.00 - 175.0	

- 9, 12, 15, 20, 25, 30, 35, 42, 43, 50, 57, 65 PSI

COMPRESSION FITTINGS

COMPRESSION SIZE SELECTION CHART

Fitting Series Guide	Color of Ends	O.D. Inches	I.D. Inches	O.D. Millimeters	I.D. Millimeters
400	Red	.455	.375	11.6	9.5
600	Green	.620	.520	15.7	13.2
700 / RA440	Black	.685 - .700	.590	17.4 - 17.8	15.0
710	Blue	.700 - .715	.600	17.8 - 18.2	15.2
790	Green	.790	.680	20.1	17.3
800	Black	.830	.720	21.1	18.3
900 / RA770	Gray / Black	.927	.817	23.5	20.8
1000	Black	1.174	1.050	29.8	26.7

COMPRESSION ADAPTER

Part No.	Model No.	End Color	Description	Bag Qty.	Price
12010107	400-CA	Red	3/8" Comp x 1/2" Spig	100	
12010213	600-CA	Green	16mm Comp x 1/2" Spig	100	
12010299	700-CA	Black	1/2" Comp x 3/4" Spig	100	
RA740	700-CA	Black	1/2" Comp x 3/4" Spig	100	
12010351	710-CA	Blue	1/2" Comp x 1/2" Spig	100	
12010407	790CA	Green	20mm Comp x 3/4" Spig	50	
12010430	800CA	Black	5/8" Comp x 1/2" Spig	100	
12010503	900-CA	Gray / Black	3/4" Comp x 3/4" Spig	50	
12010008	1000-CA-IA	Black	1" Comp x 1" Spig	50	

Gluing recommendations: for compression adapters 400-710, Use IPS #790 (or equivalent) PVC to ABS transition cement. For Compression adapter 800-1000, use IPS #711 or equivalent.



COMPRESSION X 3/4" FEMALE HOSE SWIVEL COUPLING

Part No.	Model No.	End Color	Description	Bag Qty.	Price
12010123	400-CHS-WW	Red	3/8" Comp x 3/4" FHT Swivel, with Washer	25	
12010233	600-CHS-WW	Green	16mm Comp x 3/4" FHT Swivel, with Washer	25	
12010320	700-CHS-WW	Black	1/2" Comp x 3/4" FHT Swivel, with Washer	25	
12010372	710-CHS-WW	Blue	1/2" Comp x 3/4" FHT Swivel, with Washer	25	
12010449	800-CHS-WWG	Black	5/8" Comp x 3/4" FHT Swivel, with Washer	25	
12010522	900-CHS-WWG	Gray / Black	3/4" Comp x 3/4" FHT Swivel, with Washer	25	
12010122	400-CHS-WS	Red	3/8" Comp x 3/4" FHT Swivel, with Screen	25	
12010232	600-CHS-WS	Green	16mm Comp x 3/4" FHT Swivel, with Screen	25	
12010319	700-CHS-WS	Black	1/2" Comp x 3/4" FHT Swivel, with Screen	25	
12010371	710-CHS-WS	Blue	1/2" Comp x 3/4" FHT Swivel, with Screen	25	
12010448	800-CHS-WSG	Black	5/8" Comp x 3/4" FHT Swivel, with Screen	25	
12010521	900-CHS-WSG	Gray / Black	3/4" Comp x 3/4" FHT Swivel, with Screen	25	



COMPRESSION X 3/4" MALE HOSE THREAD COUPLING

Part No.	Model No.	End Color	Description	Bag Qty.	Price
12010109	400-CE	Red	3/8" Comp x 3/4" MHT Coupling	25	
12010215	600-CE	Green	16mm Comp x 3/4" MHT Coupling	25	
12010303	700-CE	Black	1/2" Comp x 3/4" MHT Coupling	25	
12010354	710-CE	Blue	1/2" Comp x 3/4" MHT Coupling	25	
12010409	790-CE	Green	20mm Comp x 3/4" MHT Coupling	25	
12010433	800-CEG	Black	5/8" Comp x 3/4" MHT Coupling	25	
12010506	900-CEG	Grey / Black	3/4" Comp x 3/4" MHT Coupling	25	



COMPRESSION FITTINGS

COMPRESSION X 3/4" MALE HOSE THREAD COUPLING WITH CAP

Part No.	Model No.	End Color	Description	Bag Qty.	Price
12010188	400-CETC	Red	3/8" Comp x 3/4" MHT Coupling with Cap	25	
12010226	600-CETC	Green	16mm Comp x 3/4" MHT Coupling with Cap	25	
12010313	700-CETC	Black	1/2" Comp x 3/4" MHT Coupling with Cap	25	
12010365	710-CETC	Blue	1/2" Comp x 3/4" MHT Coupling with Cap	25	
12010443	800-CETCG	Black	5/8" Comp x 3/4" MHT Coupling with Cap	25	
12010516	900-CETCG	Grey / Black	3/4" Comp x 3/4" MHT Coupling with Cap	25	



COMPRESSION X 3/4" FEMALE HOSE SWIVEL TEE

Part No.	Model No.	End Color	Description	Bag Qty.	Price
12010131	400-CST-WW	Red	3/8" Comp x 3/4" FHT Swivel, with Washer	25	
12010244	600-CST-WW	Green	16mm Comp x 3/4" FHT Swivel, with Washer	25	
12010332	700-CST-WW	Black	1/2" Comp x 3/4" FHT Swivel, with Washer	25	
12010384	710-CST-WW	Blue	5/8" Comp x 3/4" FHT Swivel, with Washer	25	
12010458	800-CST-WW	Black	5/8" Comp x 3/4" FHT Swivel, with Washer	25	
12010533	900-CST-WW	Grey / Black	3/4" Comp x 3/4" FHT Swivel, with Washer	25	
12010130	400-CST-WS	Red	3/8" Comp x 3/4" FHT Swivel, with Screen	25	
12010243	600-CST-WS	Green	16mm Comp x 3/4" FHT Swivel, with Screen	25	
12010331	700-CST-WS	Black	1/2" Comp x 3/4" FHT Swivel, with Screen	25	
12010383	710-CST-WS	Blue	1/2" Comp x 3/4" FHT Swivel, with Screen	25	
12010456	800-CST-WSG	Black	5/8" Comp x 3/4" FHT Swivel, with Screen	25	
12010531	900-CST-WSG	Grey / Black	3/4" Comp x 3/4" FHT Swivel, with Screen	25	



COMPRESSION X 3/4" MALE HOSE THREAD TEE

Part No.	Model No.	End Color	Description	Bag Qty.	Price
12010106	400-C3TM	Red	3/8" Comp x 3/4" MHT Tee	25	
12010211	600-C3TM	Green	16mm Comp x 3/4" MHT Tee	25	
12010297	700-C3TM	Black	1/2" Comp x 3/4" MHT Tee	25	
12010349	710-C3TM	Blue	1/2" Comp x 3/4" MHT Tee	25	
12010428	800-C3TM	Black	5/8" Comp x 3/4" MHT Tee	25	
12010501	900-C3TM	Grey / Black	3/4" Comp x 3/4" MHT Tee	25	



COMPRESSION X MALE PIPE THREAD ADAPTER

Part No.	Model No.	End Color	Description	Bag Qty.	Price
12010234	600-CMA	Red	16mm Comp x 1/2" MIPT Adapter	25	
12010321	700-CMA	Green	1/2" Comp x 1/2" MIPT Adapter	25	
12010373	710-CMA	Black	1/2" Comp x 1/2" MIPT Adapter	25	
12010236	600-CRMAG	Green	16mm Comp x 3/4" MIPT Adapter	25	
12010323	700-CRMAG	Black	1/2" Comp x 3/4" MIPT Adapter	25	
12010375	710-CRMAG	Blue	1/2" Comp x 3/4" MIPT Adapter	25	
12010450	800-CMAG	Black	5/8" Comp x 3/4" MIPT Adapter	25	
12010523	900-CMAG	Grey / Black	3/4" Comp x 3/4" MIPT Adapter	25	



COMPRESSION X MALE PIPE THREAD TEE

Part No.	Model No.	Description	Bag Qty.	Price
TMP444	TMP444	1/2" Compression x 1/2" MIPT Tee	25	
TMP446	TMP446	1/2" Compression x 3/4" MIPT Tee	25	
TMP776	TMP776	3/4" Compression x 3/4" MIPT Tee	25	



COMPRESSION FITTINGS

COMPRESSION COUPLER

Part No.	Model No.	Description	Bag Qty.	Price
12010108	400-CC	3/8" Compression Coupler	25	
12010214	600-CC	16mm Compression Coupler	25	
12010301	700-CC	1/2" Compression Coupler	25	
12010353	710-CC	1/2" Compression Coupler	25	
12010408	790-CCG	20mm Compression Coupler	25	
12010431	800-CC	5/8" Compression Coupler	25	
12010504	900-CC	3/4" Compression Coupler	25	



COMPRESSION ELBOW

Part No.	Model No.	Description	Bag Qty.	Price
12010113	400-CELL	3/8" Compression Elbow	25	
12010220	600-CELL	16mm Compression Elbow	25	
12010307	700-CELL	1/2" Compression Elbow	25	
12010359	710-CELL	1/2" Compression Elbow	25	
12010438	800-CELL	5/8" Compression Elbow	25	
12010511	900-CELL	3/4" Compression Elbow	25	



COMPRESSION TEE

Part No.	Model No.	Description	Bag Qty.	Price
12010105	400-C3T	3/8" Compression Tee	25	
12010210	600-C3T	16mm Compression Tee	25	
12010296	700-C3T	1/2" Compression Tee	25	
12010348	710-C3T	1/2" Compression Tee	25	
12010426	800-C3T	5/8" Compression Tee	25	
12010499	900-C3T	3/4" Compression Tee	25	



COMPRESSION CROSS

Part No.	Model No.	Description	Bag Qty.	Price
X4444	X4444	1/2" Compression Cross	25	
X7777	X7777	3/4" Compression Cross	25	



COMPRESSION END PLUGS

Part No.	Model No.	Description	Bag Qty.	Price
P300	P300	3/8" Compression End Plug	25	
P400	P400	1/2" Compression End Plug	25	
P700	P700	3/4" Compression End Plug	25	
P800	P800	1" Compression End Plug	25	



FIGURE 8 END CLOSURE

Part No.	Model No.	Description	Bag Qty.	Price
12290016	400-AP8	3/8" fits up to .400" OD	100	
12290017	600-AP8	16mm fits up to .660" OD	100	
12290018	700-AP8	1/2" fits up to .720" OD	100	
12290019	800/900-AP8	3/4" fits up to .927" OD	50	
12290001	1000-AP8	1" fits up to 1.3" OD	50	



POWER-LOC™ SIZE SELECTION CHART NOMINAL TUBING SIZE

Fitting Series Guide	Acceptable I.D.		Wall Thickness	
	Inches	Millimeters	Inches	Millimeters
50	0.500 - 0.580	12.7 - 14.7	0.035 - 0.055	0.89 - 1.40
55	0.520 - 0.620	13.2 - 15.7	0.045 - 0.055	1.14 - 1.40
60	0.580 - 0.675	14.7 - 17.1	0.025 - 0.055	0.64 - 1.40
70	0.665 - 0.765	16.9 - 19.4	0.035 - 0.055	0.89 - 1.40
80	0.790 - 0.845	20.1 - 21.5	0.045 - 0.065	1.14 - 1.65
100	1.035 - 1.075	26.3 - 27.3	0.062 - 0.075	1.57 - 1.91

POWER-LOC™ COUPLING

Part No.	Model No.	Description	Bag Qty.	Price
12050005	PL-50-PC	Coupling	25	
72050305	PL-55-PC	Coupling	25	
12050105	PL-60-PC	Coupling	25	
12050205	PL-70-PC	Coupling	25	
12050607	PL-80-PC	Coupling	25	
12050611	PL-100-PC	Coupling	25	



POWER-LOC™ TEE

Part No.	Model No.	Description	Bag Qty.	Price
12050001	PL-50-P3T	Tee	25	
72050301	PL-55-P3T	Tee	25	
12050101	PL-60-P3T	Tee	25	
12050201	PL-70-P3T	Tee	25	
12050606*	PL-80-P3T	Tee	10	
12050619*	PL-100-P3T	Tee	10	

* Glued fittings



POWER-LOC™ X 3/4" FH SWIVEL TEE W/ WASHER

Part No.	Model No.	Description	Bag Qty.	Price
12050002	PL-50-PST-WW	with Washer	25	
72050302	PL-55-PST-WW	with Washer	25	
12050102	PL-60-PST-WW	with Washer	25	
12050202	PL-70-PST-WW	with Washer	25	
12050600	PL-80-PST-WW	with Washer	25	
12050610	PL-100-PST-WW	with Washer	25	



POWER-LOC™ X 3/4" FH SWIVEL TEE WITH SCREEN

Part No.	Model No.	Description	Bag Qty.	Price
12050003	PL-50-PST-WS	with Screen	25	
72050315	PL-55-PST-WS	with Screen	25	
12050103	PL-60-PST-WS	with Screen	25	
12050203	PL-70-PST-WS	with Screen	25	
12050601	PL-80-PST-WS	with Screen	25	
12050612	PL-100-PST-WS	with Screen	25	



POWER-LOC™ X BARB ADAPTER TEE

Part No.	Model No.	Description	Bag Qty.	Price
12050043	PL-50-400BT	Barb Adapter Tee	25	
12050045	PL-50-700BT	Barb Adapter Tee	25	
12050143	PL-60-400BT	Barb Adapter Tee	25	
12050145	PL-60-700BT	Barb Adapter Tee	25	
12050243	PL-70-400BT	Barb Adapter Tee	25	
12050245	PL-70-700BT	Barb Adapter Tee	25	



POWER-LOC™ X 3/4" MHT ADAPTER TEE

Part No.	Model No.	Description	Bag Qty.	Price
12050032	PL-50-P3TM	MHT Adapter Tee	25	
12050508	PL-60-P3TM	MHT Adapter Tee	25	
12050530	PL-70-P3TM	MHT Adapter Tee	25	



POWER-LOC™ TEE W/ 1/2" SOCKET / 3/4" SPIGOT

Part No.	Model No.	Description	Bag Qty.	Price
12050046	PL-50-SSPT	Socket / Spigot	25	
12050146	PL-60-SSPT	Socket / Spigot	25	
12050246	PL-70-SSPT	Socket / Spigot	25	



POWER-LOC™ TEE W/ 3/4" SOCKET / 1" SPIGOT

Part No.	Model No.	Description	Bag Qty.	Price
12050047	PL-50-SSP1T	Socket / Spigot	25	
12050147	PL-60-SSP1T	Socket / Spigot	25	
12050247	PL-70-SSP1T	Socket / Spigot	25	



POWER-LOC™ 90° ELBOW

Part No.	Model No.	Description	Bag Qty.	Price
12050004	PL-50-PELL	90° Elbow	25	
72050304	PL-55-PELL	90° Elbow	25	
12050104	PL-60-PELL	90° Elbow	25	
12050204	PL-70-PELL	90° Elbow	25	
12050617*	PL-80-PELL	90° Elbow	20	
12050618*	PL-100-PELL	90° Elbow	20	

* Glued fittings



POWER-LOC™ X 3/4" FH SWIVEL W/ WASHER

Part No.	Model No.	Description	Bag Qty.	Price
12050026	PL-50-PSELL-WW	With Washer	25	
12050120	PL-60-PSELL-WW	With Washer	25	
12050232	PL-70-PSELL-WW	With Washer	25	



POWER-LOC™ X MALE HOSE ADAPTER (1/2" MPT)

Part No.	Model No.	Description	Bag Qty.	Price
12050009	PL-50-P1/2-MA	1/2" MPT	25	
72050308	PL-55-P1/2-MA	1/2" MPT	25	
12050109	PL-60-P1/2-MA	1/2" MPT	25	
12050209	PL-70-P1/2-MA	1/2" MPT	25	



POWER-LOC™ X MALE HOSE ADAPTER (3/4" MPT)

Part No.	Model No.	Description	Bag Qty.	Price
12050010	PL-50-P3/4-MA	3/4" MPT	25	
72050317	PL-55-P3/4-MA	3/4" MPT	25	
12050110	PL-60-P3/4-MA	3/4" MPT	25	
12050210	PL-70-P3/4-MA	3/4" MPT	25	
12050604	PL-80-P3/4-MA	3/4" MPT	25	
12050704	PL-100-P3/4-MA	3/4" MPT	25	



POWER-LOC™ X MALE HOSE ADAPTER (3/4" MHT)

Part No.	Model No.	Description	Bag Qty.	Price
12050011	PL-50-PMT	3/4" MHT	25	
72050311	PL-55-PMT	3/4" MHT	25	
12050111	PL-60-PMT	3/4" MHT	25	
12050211	PL-70-PMT	3/4" MHT	25	
12050603	PL-80-PMT	3/4" MHT	25	
12050711	PL-100-PMT	3/4" MHT	25	



POWER-LOC™ X 500 HOSE REDUCING COUPLING

Part No.	Model No.	Description	Bag Qty.	Price
12050313	PL-60X50-PRC	Reducing Coupling	25	
12050013	PL-70X50-PRC	Reducing Coupling	25	



POWER-LOC™ X TAPE-LOC ADAPTERS

Part No.	Model No.	Description	Bag Qty.	Price
12010020	PL-50X06-LS	PL x TL Adapters	50	
12010025	PL-60X06-LS	PL x TL Adapters	50	
12010032	PL-50X09-LS	PL x TL Adapters	50	
12010035	PL-60X09-LS	PL x TL Adapters	50	
12010085	PL-80X09-LS	PL x TL Adapters	50	



POWER-LOC™ X BARB ADAPTER

Part No.	Model No.	Description	Bag Qty.	Price
12050042	PL-50-400B	400 Barb	50	
12050044	PL-50-700B	700 Barb	50	
12050142	PL-60-400B	400 Barb	50	
12050144	PL-60-700B	700 Barb	50	
12050242	PL-70-400B	400 Barb	50	
12050244	PL-70-700B	700 Barb	50	
12050644	PL-80-700B	700 Barb	50	



POWER-LOC™ W/ 3/4" FHT THREADED CAP

Part No.	Model No.	Description	Bag Qty.	Price
12050006	PL-50-PETC	3/4" Threaded Cap	25	
72050306	PL-55-PETC	3/4" Threaded Cap	25	
12050106	PL-60-PETC	3/4" Threaded Cap	25	
12050206	PL-70-PETC	3/4" Threaded Cap	25	
12050620	PL-80-PETC	3/4" Threaded Cap	25	
12050720	PL-100-PETC	3/4" Threaded Cap	25	



POWER-LOC™ W/ 3/4" FEMALE HOSE SWIVEL W/ WASHER

Part No.	Model No.	Description	Bag Qty.	Price
12050007	PL-50-PHS-WW	FHS with Washer	25	
72050307	PL-55-PHS-WW	FHS with Washer	25	
12050107	PL-60-PHS-WW	FHS with Washer	25	
12050207	PL-70-PHS-WW	FHS with Washer	25	
12050605	PL-80-PHS-WW	FHS with Washer	25	
12050614	PL-100-PHS-WW	FHS with Washer	25	



POWER-LOC™ W/ 3/4" FEMALE HOSE SWIVEL W/ SCREEN

Part No.	Model No.	Description	Bag Qty.	Price
12050008	PL-50-PHS-WS	FHS with Screen	25	
72050316	PL-55-PHS-WS	FHS with Screen	25	
12050108	PL-60-PHS-WS	FHS with Screen	25	
12050208	PL-70-PHS-WS	FHS with Screen	25	
12050606	PL-80-PHS-WS	FHS with Screen	25	
12050615	PL-100-PHS-WS	FHS with Screen	25	



POWER-LOC™ PIPE THREAD SWIVEL

Part No.	Model No.	Description	Bag Qty.	Price
72050325	PL-55-PPS-WW	Pipe Thread Swivel	25	
12050326	PL-60-PPS-WW	Pipe Thread Swivel	25	



POWER-LOC™ W/ 1/2" SOCKET, 3/4" SPIGOT

Part No.	Model No.	Description	Bag Qty.	Price
12050019	PL-50-SSP	Socket / 3/4" Spigot	25	
72050324	PL-55-SSP	Socket / 3/4" Spigot	25	
12050121	PL-60-SSP	Socket / 3/4" Spigot	25	
12050219	PL-70-SSP	Socket / 3/4" Spigot	25	
12050608	PL-80-SSP	Socket / 3/4" Spigot	25	
12050708	PL-100-SSP	Socket / 3/4" Spigot	25	



POWER-LOC™ W/ 3/4" SOCKET, 1" SPIGOT

Part No.	Model No.	Description	Bag Qty.	Price
12050018	PL-50-SSP1	Socket / 1" Spigot	25	
72050321	PL-55-SSP1	Socket / 1" Spigot	25	
12050124	PL-60-SSP1	Socket / 1" Spigot	25	
12050220	PL-70-SSP1	Socket / 1" Spigot	25	
12050602	PL-80-SSP1	Socket / 1" Spigot	25	
12050613	PL-100-SSP1	Socket / 1" Spigot	25	



POWER-LOC™ X LAYFLAT CONNECTOR

Part No.	Model No.	Description	Bag Qty.	Price
12051021	31-H5LF	50 Series - Replaces 505-KMA	50	
12041068	31-H6LF	60 Series - Replaces 565-KMA	50	
12051116	31-H7LF	70 Series	50	

Use LFP-1 Punch (Orange). Use AP-H-2 Handle to install.



POWER-LOC™ X LAYFLAT ADAPTERS SHUT-OFF VALVE

Part No.	Model No.	Description	Bag Qty.	Price
12051029	KMA-VAL-PL-50	Shut-Off Valve	50	
12051030	KMA-VAL-PL-60	Shut-Off Valve	50	



POWER-LOC™ END FLUSH VALVE

Part No.	Model No.	Description	Bag Qty.	Price
12050012	PL-50-PEF	Green Handle	25	
12050015	PL-50-PEFB	Black Handle	25	
72050312	PL-55-PEF	Green Handle	25	
12050113	PL-60-PEF	Green Handle	25	
12050115	PL-60-PEFB	Black Handle	25	
12050213	PL-70-PEF	Green Handle	25	
12050215	PL-70-PEFB	Black Handle	25	



POWER-LOC™ X MPT WITH BALL VALVE

Part No.	Model No.	Description	Bag Qty.	Price
12062006	HV5TH50	1/2" MPT	50	
12062008	HV6TH50	1/2" MPT	50	
12062015	HV7TH50	1/2" MPT	50	
12062034	HV8TH50	1/2" MPT	50	
12062003	HV5TH75	3/4" MPT	50	
12062009	HV6TH75	3/4" MPT	50	
12062012	HV7TH75	3/4" MPT	50	
12062014	HV8TH75	3/4" MPT	50	



POWER-LOC™ W/ BALL VALVE, 1/2" SOCKET, 3/4" SPIGOT

Part No.	Model No.	Description	Bag Qty.	Price
12050017	SSP-BV-PL-50	Socket / 3/4" Spigot	25	
72050322	SSP-BV-PL-55	Socket / 3/4" Spigot	25	
12050118	SSP-BV-PL-60	Socket / 3/4" Spigot	25	
12050217	SSP-BV-PL-70	Socket / 3/4" Spigot	25	



POWER-LOC™ W/ BALL VALVE, 3/4" SOCKET, 1" SPIGOT

Part No.	Model No.	Description	Bag Qty.	Price
12050016	SSP1-BV-PL-50	Socket / 1" Spigot	25	
72050323	SSP1-BV-PL-55	Socket / 1" Spigot	25	
12050119	SSP1-BV-PL-60	Socket / 1" Spigot	25	
12050216	SSP1-BV-PL-70	Socket / 1" Spigot	25	



POWER-LOC™ COUPLING W/ BALL VALVE

Part No.	Model No.	Description	Bag Qty.	Price
12050127	PL-50-BV-PC	with Ball Valve	25	
72050314	PL-55-BV-PC	with Ball Valve	25	
12050126	PL-60-BV-PC	with Ball Valve	25	
12050223	PL-70-BV-PC	with Ball Valve	25	



POWER-LOC™ COUPLING WITH BALL VALVE

Part No.	Model No.	Description	Bag Qty.	Price
72062000	HV55	50 Series	25	
12062005	HV66	60 Series	25	
12062011*	HV77	70 Series	25	
12062013*	HV88	80 Series	25	
* Rabbit Cylinder				



POWER-LOC™ W/ BALL VALVE X BARB

Part No.	Model No.	Description	Bag Qty.	Price
12050040	250B-BV-PL-50	250 Barb	25	
12050140	250B-BV-PL-60	250 Barb	25	
12050240	250B-BV-PL-70	250 Barb	25	
12062001	31-HV5B400	50 Series	50	
12062007	31-HV6B400	60 Series	50	



POWER-LOC™ TEE X AUTOMATIC FLUSH VALVE - LOW PRESSURE

Part No.	Model No.	Description	Bag Qty.	Price
12050051	PL-50-P3TM-FCH-L	Low Pressure	25	
12050151	PL-60-P3TM-FCH-L	Low Pressure	25	
12050251	PL-70-P3TM-FCH-L	Low Pressure	25	



POWER-LOC™ TEE X AUTOMATIC FLUSH VALVE - HIGH PRESSURE

Part No.	Model No.	Description	Bag Qty.	Price
12050061	PL-50-P3TM-FCH-H	High Pressure	25	
12050161	PL-60-P3TM-FCH-H	High Pressure	25	
12050261	PL-70-P3TM-FCH-H	High Pressure	25	



POWER-LOC™ X MHT ADAPTER & FLUSH VALVE - LOW PRESSURE

Part No.	Model No.	Description	Bag Qty.	Price
12050050	PL-50-MTFCH-L	Low Pressure	25	
12050150	PL-60-MTFCH-L	Low Pressure	25	
12050250	PL-70-MTFCH-L	Low Pressure	25	
12050628	PL-80-MTFCH-L	Low Pressure	25	



POWER-LOC™ X MHT ADAPTER & FLUSH VALVE - HIGH PRESSURE

Part No.	Model No.	Description	Bag Qty.	Price
12050060	PL-50-MTFCH-H	High Pressure	25	
12050160	PL-60-MTFCH-H	High Pressure	25	
12050260	PL-70-MTFCH-H	High Pressure	25	
12050630	PL-80-MTFCH-H	High Pressure	25	



TAPE-LOC® FITTINGS

TAPE-LOC® SIZE CHART

Tape-Loc Fittings are designed for use with drip tape.

Tape-Loc® Series	used for Tape I.D. Size
"06" Series	5/8" I.D. Tapes
"08" Series	3/4" I.D. Tapes
"09" Series	7/8" I.D. Tapes
"10" Series	1" I.D. Tapes
"11" Series	1-1/8" I.D. Tapes
"14" Series	1-3/8" I.D. Tapes

**FLAT TAPE WIDTHS
(SHOWN ACTUAL SIZE)**

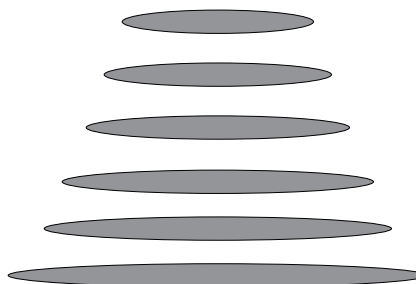

TAPE-LOC® COUPLING

Part No.	Model No.	Description	Bag Qty.	Price
12030062	CPT-06-LSO	5/8" Tape-Loc Coupling	50	
12030032	CPT-09-LSO	7/8" Tape-Loc Coupling	50	
12030135	CPT-11-LS	1-1/8" Tape-Loc Coupling	25	
12030025	CPT-14-LS	1-3/8" Tape-Loc Coupling	25	



TAPE-LOC® X COMPRESSION

Part No.	Model No.	Description	Bag Qty.	Price
12030030	CSP-06-LS400	5/8" Tape-Loc x 3/8" Compression	50	
12030033	CSP-06-LS600	5/8" Tape-Loc x 16mm Compression	50	
12030036	CSP-06-LS710	5/8" Tape-Loc x 1/2" Compression	50	
12030041	CSP-09-LS600	7/8" Tape-Loc x 16mm Compression	50	
12030043	CSP-09-LS710	5/8" Tape-Loc x 1/2" Compression	50	
12030047	CSP-09-LS1-900	1-3/8" Tape-Loc x 3/4" Compression	25	
12030147	CSP-11-LS1-900	1-1/8" Tape-Loc x 3/4" Compression	25	



TAPE-LOC® X SOCKET/SPIGOT

Part No.	Model No.	Description	Bag Qty.	Price
12030085	SSP-06-LS	5/8" Tape-Loc x 1/2" Soc / 3/4" Spigot	50	
12030087	SSP-09-LS	7/8" Tape-Loc x 1/2" Soc / 3/4" Spigot	50	
12030088	SSP-09-LS1	7/8" Tape-Loc x 3/4" Soc / 1" Spigot	50	
12030089	SSP-09-LS2	7/8" Tape-Loc x 1" Soc / 1-1/4" Spigot	50	
12030136	SSP-11-LS1	1-1/8" Tape-Loc x 3/4" Soc / 1" Spigot	25	
12030090	SSP-14-LS2	1-3/8" Tape-Loc x 1" Soc / 1-1/4" Spigot	25	



TAPE-LOC® X BARB

Part No.	Model No.	Description	Bag Qty.	Price
12030004	250B-06-LS	5/8" Tape-Loc x 250 (1/4") Barb	50	
12030008	400B-06-LS	5/8" Tape-Loc x 400 (3/8") Barb	50	
12030112	520I-06-LS	5/8" Tape-Loc x 520 (16mm) Barb	50	
12030014	700B-06-LS	5/8" Tape-Loc x 700 (1/2") Barb	50	
12030015	700B-09-LS	7/8" Tape-Loc x 700 (1/2") Barb	50	



TAPE-LOC® X BARB WITH TAMPER RESISTANT SHUTOFF VALVE

Part No.	Model No.	Description	Bag Qty.	Price
12030005	250BV-06-LS	5/8" Tape-Loc x 250 (1/4") Barb w/ Valve	50	
12030010	400BV-06-LS	5/8" Tape-Loc x 400 (3/8") Barb w/ Valve	50	



TAPE-LOC® X MALE THREAD

Part No.	Model No.	Description	Bag Qty.	Price
12030076	MA-06-LS	5/8" Tape-Loc x 1/2" MIPT	50	
12030017	MA-06-LS1	3/4" Tape-Loc x 3/4" MIPT	50	
12030077	MA-09-LS	7/8" Tape-Loc x 3/4" MIPT	50	
12030081	MHT-06-LS	5/8" Tape-Loc x 3/4" MHT	50	
12030082	MHT-09-LS	5/8" Tape-Loc x .520" MHT (16mm Barb)	50	



TAPE-LOC® X FEMALE HOSE SWIVEL

Part No.	Model No.	Description	Bag Qty.	Price
12030071	FHS-06-LS-WW	5/8" Tape-Loc x 3/4" FHT w/ Washer	50	
12030151	FHS-09-LS-WW	7/8" Tape-Loc x 3/4" FHT w/ Washer	50	



TAPE-LOC® X LAY FLAT CONNECTOR

Part No.	Model No.	Description	Bag Qty.	Price
12030064	FHC-06-PLUG	Tape-Loc x Lay Flat Plug for 5/8" & 7/8"	50	



TAPE-LOC® X LAY FLAT CONNECTOR

Part No.	Model No.	Description	Bag Qty.	Price
12030063	FHC-06-LS	5/8" Tape-Loc x Lay Flat	50	
12030065	FHC-09-LS	7/8" Tape-Loc x Lay Flat	50	



TAPE-LOC® TEE

Part No.	Model No.	Description	Bag Qty.	Price
12030092	TEE-06-LS	5/8" Tape-Loc Tee	50	



TAPE-LOC® X COMPRESSION TEE

Part No.	Model No.	Description	Bag Qty.	Price
12030097	TEE-06-LSL1/2	Tape-Loc x 1/2" Socket / 3/4" Spigot Tee	50	



TAPE-LOC® X COMPRESSION TEE

Part No.	Model No.	Description	Bag Qty.	Price
12030100	TEE-06-LSL600	5/8" Tape-Loc Tee x 16mm Comp. Tee	50	



TAPE-LOC® X FHT SWIVEL TEE

Part No.	Model No.	Description	Bag Qty.	Price
12030073	LST-06-LS-WW	5/8" Tape-Loc x FHT Swivel Tee	50	



TAPE-LOC® 90° ELBOW

Part No.	Model No.	Description	Bag Qty.	Price
12030049	ELL-06-LS	5/8" Tape-Loc Elbow	50	
12030146	ELL-09-LS	7/8" Tape-Loc Elbow		



TAPE-LOC® 90° ELBOW

Part No.	Model No.	Description	Bag Qty.	Price
12030053	END-06-LSC	5/8" Tape-Loc x Hose Thread Cap	50	
12030054	END-09-LSC	7/8" Tape-Loc x Hose Thread Cap	50	



TAPE-LOC® X BALL VALVE X SOCKET / SPIGOT

Part No.	Model No.	Description	Bag Qty.	Price
12030117	SSP-BV-06-LS	5/8" Tape-Loc x 1/2" Soc / 3/4" Spig	25	
12030118	SSP-BV-09-LS	7/8" Tape-Loc x 1/2" Soc / 3/4" Spig	25	
12030119	SSP1-BV-09-LS	7/8" Tape-Loc x 3/4" Soc / 1" Spig	25	



TAPE-LOC® X SHUT-OFF VALVE

Part No.	Model No.	Description	Bag Qty.	Price
12030160	250B-BV-06-LS	5/8" Tape-Loc x 250 Barb	50	
12030165	400B-BV-06-LS	5/8" Tape-Loc x 400 Barb	50	
12030175	PT50-BV-06-LS	5/8" Tape-Loc x 1/2" MIPT	50	
12030177	PT75-BV-06-LS	5/8" Tape-Loc x 3/4" MIPT	50	



TAPE-LOC® X WITH SHUT-OFF VALVE

Part No.	Model No.	Description	Bag Qty.	Price
12062019	31-TV5B250	5/8" Tape-Loc x 250 Barb	50	
12062020	31-TV5B400	5/8" Tape-Loc x 400 Barb	50	
12062023	31-TV5TH50	5/8" Tape-Loc x 1/2" MIPT	50	
12062024	31-TV5TH75	5/8" Tape-Loc x 3/4" MIPT	50	



TAPE-LOC® X COUPLING SHUT-OFF VALVE

Part No.	Model No.	Description	Bag Qty.	Price
12030131	CPT-BV-06-LS	5/8" Tape-Loc Coupling Shut-off	50	
12030048	CPT-BV-09-LS	7/8" Tape-Loc Coupling Shut-off	50	



TAPE-LOC® X COUPLING WITH SHUT-OFF VALVE

Part No.	Model No.	Description	Bag Qty.	Price
12062018	31-TV55	5/8" Tape-Loc Coupling with Shut-off	50	
12062026	31-TV77	7/8" Tape-Loc Coupling with Shut-off	50	



TAPE-LOC® X LAY FLAT VALVE CONNECTOR (SMALL SHAFT ON TEARDROP)

Part No.	Model No.	Description	Bag Qty.	Price
12051028	FHC-VAL-06-LS	5/8" Tape-Loc Coupling with Shut-off	50	
12051069	FHC-VAL-09-LS	7/8" Tape-Loc Coupling with Shut-off	50	



TAPE-LOC® ADJUSTABLE SLIP FITTING

Part No.	Model No.	Description	Bag Qty.	Price
12030040	BASF-09-LS	7/8" Tape-Loc Adjustable Slip Fitting	50	
12030137	BASF-11-LS	1-1/8" Tape-Loc Adjustable Slip Fitting	50	



For use with 31-H5LF (12051021) and 620x520 c/l 40 (11200078)

NETAFIM™ RISER CONNECTORS

COUPLERS

Direct Connection from Thinwall Dripperline (TWD) to Polyethylene (PE) Tubing

Part No.	Model Number	Description	Bag Qty.	Price
00115-005500	T63036651617-B	630 TWD x 16mm PE	100	
00115-005750	T63036651817-B	630 TWD x 18mm PE	100	
00115-005900	T63036652017	630 TWD x 20mm PE	900	
00115-007850	T87536651822-B	875 TWD x 18mm PE	100	
00115-007950	T87536652022-B	875 TWD x 20mm PE	100	



START CONNECTORS

Direct Connection from PVC Submain to Polyethylene (PE) Tubing

Part No.	Model Number	Description	Bag Qty.	Price
00115-001600	H52034260160-B	16mm PE x PVC with Grommet	100	
00115-002550	H57034260180-B	18mm PE x PVC with Grommet	100	
00115-003550	H68034260200-B	20mm PE x PVC with Grommet	100	



Requires 5/8" Drill Size (15.88mm)

START CONNECTORS

Direct Connection from PVC Submain to Thinwall (TWD)

Part No.	Model Number	Description	Bag Qty.	Price
00115-005150	H63036450170-B	630 Series TWD x PVC with Grommet	100	
00115-007450	H87536450220-B	875 Series TWD x PVC with Grommet	100	

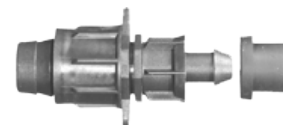

Requires 5/8" Drill Size (15.88mm)

COUPLERS

Direct Connection from Thinwall (TWD) to Thinwall (TWD)

Part No.	Model Number	Description	Bag Qty.	Price
00115-004550	T63036100170-B	630 Series TWD x 630 Series TWD	100	
00115-007050	T87536100220-B	875 Series TWD x 875 Series TWD	50	



START CONNECTORS

Direct Connection from PVC Submain to Polyethylene (PE) Tubing

Part No.	Model Number	Description	Bag Qty.	Price
32500-013720	H520IAPVC-B	0.520" PE Insert Adapter to PVC with 0.680" Grommet (16.5mm drill bit size) fits 0.520" x 0.620" PE Tubing	50	
32500-010330	H680IAPVC-B	0.680" PE Insert Adapter to PVC with 0.680" Grommet (16.5mm drill bit size) fits 0.720" x 0.840" PE Tubing	50	
32500-018420	H820IAPVC-B	0.820" PE Insert Adapter to PVC with 0.680" Grommet (19mm) fits 0.820" x 0.940" PE Tubing (23.8mm hole saw)	50	
32000-007015	HGROMM680-B	Grommet for use with H520IAPVC-B and H680IAPVC-B	50	
00115-000650	HGROMM820	Grommet for use with H820IAPVC-B	1	



START CONNECTORS MALE ADAPTER

Thinwall dripperline MIPT Male Adapter with Twist Lock.

Transitions MIPT coupling to thinwall dripperline.

Part No.	Model Number	Description	Bag Qty.	Price
00115-004750	T6303620017C-B	630 TWD x 1/2" MIPTS Adapter	100	
00115-004850	T6303620017D-B	630 TWD x 3/4" MIPTS Adapter	100	
00115-007150	T8753620022D-B	875 TWD x 3/4" MIPTS Adapter	100	



RAIN BIRD® DRIPLINE FITTINGS

RAIN BIRD® DRIPLINE XF™ SERIES 17MM INSERT FITTINGS

Part No.	Description	Bag Qty.	Price
XFD-COUP	Insert Coupling	25	
XFD-ELBOW	Insert Elbow	25	
XFD-TEE	Insert Tee	10	

Rain Bird's 17mm barbed insert fittings are used with all Rain Bird XF Series Dripline, including XFD Dripline and XFS Subsurface Dripline. They have been redesigned and can now be installed over twice as fast as other barbed fittings*



NETAFIM™ TECHLINE & CONNECTOR FITTINGS

NETAFIM™ TECHLINE® 17MM FITTINGS

Part No.	Description	Bag Qty.	Price
TLCOUP	Insert Coupling	25	
TLELL	Insert Elbow	25	
TLTEE	Insert Tee	25	
TL050MA	1/2" Male Adapter	25	
TL075MA	3/4" Male Adapter	25	
TLCROS	Insert Cross	25	
TL075FTEE	Insert x Insert x 3/4" FIPT Combination Tee	10	
TL2W075MA	3/4" MIPT x Insert "V"	10	
TLIAPE-B	Insert Adapter for 1" or Larger PE	50	
TLIAPVC-B	Insert Adapter for 1-1/2" or Larger PVC	50	
TL050MFV-1	1/2" MIPT Automatic Flush Valve	1	
TLFV-1	Insert Automatic Flush Valve	1	
TLAVRV	1/2" MIPT Air / Vacuum Relief Valve	10	
TLCV-B	In-Line Check Valve - Insert	10	
TLCV050M-B	In-Line Check Valve - 1/2" MIPT	10	
TLS6	6" Soil Staple	25	

Compatible with Dripperline .660" OD X .560" ID

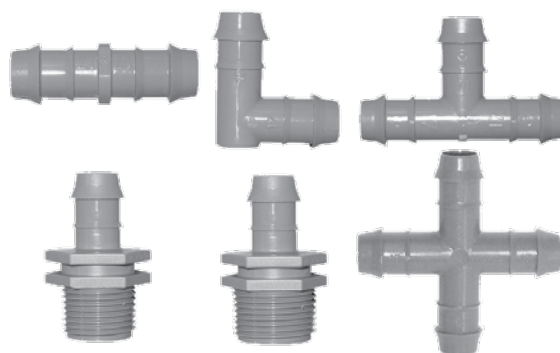

JAIN® POLY BARBED & THREADED FITTINGS

JAIN® POLY BARBED & THREADED FITTINGS

Part No.	Description	Bag Qty.	Price
12290075	.375" ID Insert Coupler for 12mm OD Tubing	100	
12290078	.520" ID Insert Coupler for 16mm OD Tubing	100	
12290082	.620" ID Insert Coupler for 18mm OD Tubing	100	
12290085	.710" ID Insert Coupler for 20mm OD Tubing	50	
12290077	.375" ID Insert Tee for 12mm OD Tubing	100	
12290080	.520" ID Insert Tee for 16mm OD Tubing	100	
12290084	.620" ID Insert Tee for 18mm OD Tubing	50	
12290087	.710" ID Insert Tee for 20mm OD Tubing	50	
12290076	.375" ID Insert Elbow for 12mm OD Tubing	100	
12290079	.520" ID Insert Elbow for 16mm OD Tubing	100	
12290083	.620" ID Insert Elbow for 18mm OD Tubing	50	
12290086	.710" ID Insert Elbow for 20mm OD Tubing	50	
12290081	.520" ID Ins. x 3/4" MIPT for 16mm OD Tubing	50	



JAIN® / API® CONNECTOR FITTINGS & GROMMETS

JAIN® / API® EPDM PIPE GROMMETS

Part No.	Description	Bag Qty.	Price
12290031	400-GRO For 400 Series Barbs For Min. 1" Diameter PVC Pipe	100	
12290032	700-GRO For 700 Series Barbs For Min. 1-1/2" Diameter PVC Pipe	100	
12020002	1000-GRO For 1000 Series Barbs For Min. 3" Dia. PVC Pipe	50	

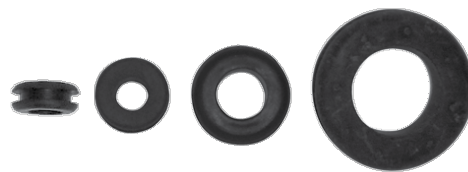

JAIN® / API® CONNECTOR FITTINGS

Part No.	Description	Bag Qty.	Price
12030009	400 Barb x 0.520" (16mm) Insert Barb	25	
120400XX	400 Barb x .400, .600, .700 Compression	50	
12040044	400 Barb x 1/2" Socket / 3/4" Spigot	50	
12040045	400 Barb x 1/2" Spigot	50	
12040046	400 Barb x 400 Barb Coupling	250	
12290036	400 Barbed Plug for 400-GRO	50	
120400XX	700 Barb x .600 or .710 Compression	50	
12040061	700 Barb x 1/2" Socket / 3/4" Spigot	50	
12040092	700 Barb x 3/4" Socket / 1" Spigot	50	
12040062	700 Barb x 1/2" Spigot	50	
12040063	700 Barb x 700 Barb Coupling	250	
12290037	700 Barb Plug for 700-GRO	50	
12040006	1000 Barb x 1" Socket / 1-1/4" Spigot	25	



CONNECTOR FITTINGS & GROMMETS

CONNECTOR FITTINGS AND BARBED COUPLINGS

Part No.	Description	Bag Qty.	Price
101001886	Head Connector Grommet	1000	
101001883	Head Connector 12mm Diameter	500	
101001885	Head Connector 16mm Diameter	500	
101003837	Head Connector 17mm Diameter	500	
101001884	Head Connector 20mm Diameter	500	
101001887	Barbed Couplings 12mm Diameter	500	
101001889	Barbed Couplings 16mm Diameter	500	
101001965	Barbed Couplings 17mm Diameter	500	
101001888	Barbed Couplings 20mm Diameter	500	



OUTLET ADAPTERS

VINYL BUNGIE ADAPTER

Part No.	Description	Bag Qty.	Price
TA50	1/2" FIPT Vinyl Grommet Adapter (use HSA-100)	50	
TA75	3/4" FIPT Vinyl Grommet Adapter (use HSA-1316)	50	
TA100	1" FIPT Vinyl Grommet Adapter (use HSA-1716)	50	

HSA = Hole Saw - Not for use with pressure exceeding 40 PSI

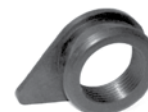

ONE PIECE BONDABLE SADDLE, SOCKET / SPIGOT

Part No.	Description	Bag Qty.	Price
See Below For Part Numbers	1/2" Socket / 3/4" Spigot	25	
	3/4" Socket / 1" Spigot	25	
	1" Socket / 1 1/4" Spigot	25	



Outlet Size	Pipe Size						
	1-1/2" Black	2" White	2-1/2" Gray	3" Brown	4" Green	6" Blue	8"-10" Orange
1/2" / 3/4"	12080035	12080036	12080037	12080038	12080039	12080041	---
3/4" / 1"	---	12080049	12080050	12080051	12080052	12080054	12080055
1" / 1-1/4"	---	---	---	---	12080043	12080045	---

Use of a heavy bodied cement IPS #719 or equivalent is recommended. Always prime pipe and fitting.

RISER TUBING

RISER LINE - POLYETHYLENE

Part No.	Model Number	Description	Coil Length	Price
40510-000003	14052062	0.520" x 0.620" PE Riser Tubing	1000'	
40510-000014	14072084	0.720" x 0.840" PE Riser Tubing	1000'	
40510-000017	14082093	0.820" x 0.930" PE Riser Tubing	500'	



FLEX VINYL IRRIGATION HOSE

Part No.	Model Number	Description	Coil Length	Price
1/2-IH	11210034	0.500" x 0.680" 1/2" Flex Irrigation Hose	500'	
5/8-IH	11210093	0.625" x 0.825" 5/8" Flex Irrigation Hose	300'	
3/4-IH	11210054	0.750" x 0.970" 3/4" Flex Irrigation Hose	200'	



WIRE TIES & TOOLS

GALVANIZED WIRE TIES

Part No.	Description	5M Bundle	Price
18GALV4	4" 18GA Galvanized Wire Tie		
18GALV6	6" 18GA Galvanized Wire Tie		
18GALV8	8" 18GA Galvanized Wire Tie		



STAINLESS STEEL WIRE TIES

Part No.	Description	5M Bundle	Price
18STST4	4" 18GA Stainless Steel Wire Tie		
18STST6	6" 18GA Stainless Steel Wire Tie		
18STST7	7" 18GA Stainless Steel Wire Tie		
18STST8	8" 18GA Stainless Steel Wire Tie		
16STST7	7" 16GA Stainless Steel Wire Tie		
16STST8	8" 16GA Stainless Steel Wire Tie		

WIRE TIE TOOLS

Part No.	Description	Price
HTTB	Wire Tie Twister Black Handle	
BTP	Red Plastic Handle Automatic Tool	



BERMAD CONTROL VALVES

BERMAD SOLENOID VALVE WITH FLOW CONTROL

Part No.	Size	Description	Price
210-015GP-ONP-M	1-1/2"	200 Series Control Valve w/ Flow Control	
210-020GP-ONP-M	2"	200 Series Control Valve w/ Flow Control	
110-030YP-ONP-M	3/23	100 Series HYFLOW Valve w/ Flow Control	

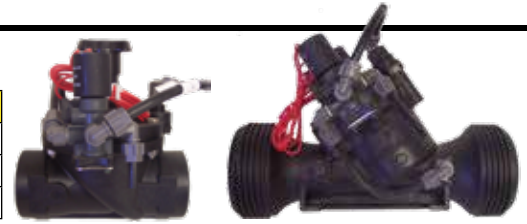

BERMAD PRESSURE REDUCING SOLENOID VALVE

Part No.	Size	Description	Price
120-55-020YP-ONP-M	2"	100 Series HYFLOW Pressure Reducing Valve	
120-55-030YP-ONP-M	3/23	100 Series HYFLOW Pressure Reducing Valve	
120-55-03LYP-ONP-M	3"	100 Series HYFLOW Pressure Reducing Valve	
120-55-040YP-OA1-5	4"	100 Series HYFLOW Pressure Reducing Valve	



BERMAD PRESSURE SUSTAINING NORMALLY OPEN SOLENOID VALVE

Part No.	Size	Description	Price
130-030YP-ONP-M	3/23	100 Series HYFLOW PSNO Valve	
130-030YP-ONP-5	3"	100 Series HYFLOW PSNO Valve	
130-040YP-OA1-5	4"	100 Series HYFLOW PSNO Valve	



BERMAD PRESSURE RELIEF VALVE - MANUAL

Part No.	Size	Description	Price
230-020GP-ONP-M	2"	Pressure Relief Globe Valve, 10 - 80 PSI	
230-020AP-ONP-M	2"	Pressure Relief Angle Valve, 10 - 80 PSI	



NETAFIM™ CONTROL VALVES

NETAFIM™ PRESSURE REDUCING ELECTRIC VALVE

Part No.	Size	Description	Price
61PREL2PL-Y	2"	Pressure Reducing w/ Yellow Spring 7 - 30 PSI	
61PREL323PL-Y	3/23	Pressure Reducing w/ Yellow Spring 7 - 30 PSI	
61PREL3PLS-Y	3"	Pressure Reducing w/ Yellow Spring 7 - 30 PSI	
61PREL4PLS-Y	4"	Pressure Reducing w/ Yellow Spring 7 - 30 PSI	



NETAFIM™ PRESSURE SUSTAINING NORMALLY OPEN ELECTRIC VALVE

Part No.	Size	Description	Price
61PSNO2PL-G	2"	PSNO Valve w/ Green Spring 14 - 65 PSI	
61PSNO323PL-G	3/23	PSNO Valve w/ Green Spring 14 - 65 PSI	
61PSNO3PLS-G	3"	PSNO Valve w/ Green Spring 14 - 65 PSI	
61PSNO4PLS-G	4"	PSNO Valve w/ Green Spring 14 - 65 PSI	
61PSNO6PLS-G	6"	PSNO Valve w/ Green Spring 14 - 65 PSI	



NETAFIM™ PRESSURE RELIEF VALVE - MANUAL

Part No.	Size	Description	Price
61PS2PL-G	2"	Pressure Sustaining, Green Spring, 14 - 65 PSI	
61PS323PL-G	3/23	Pressure Sustaining, Green Spring, 14 - 65 PSI	
61PS3PLS-G	3"	Pressure Sustaining, Green Spring, 14 - 65 PSI	
61PS4PLS-G	4"	Pressure Sustaining, Green Spring, 14 - 65 PSI	



NOTE: REPLACEMENT SOLENOIDS AND PARTS ARE AVAILABLE UPON REQUEST

RAIN BIRD® CONTROL VALVES

RAIN BIRD® DV SERIES VALVE

Part No.	Description	Case Qty	Price
75DV	3/4" FIPT without Flow Control	20	
100DVF	1" FIPT with Flow Control	20	
100DV	1" FIPT without Flow Control	20	
100DVFSS	1" Slip with Flow Control	20	
100DVSS	1" Slip without Flow Control	20	

RAIN BIRD® PGA GLOBE / ANGLE VALVE

Part No.	Description	Case Qty	Price
100PGA	1" FIPT with Flow Control	10	
150PGA	1-1/2" FIPT with Flow Control	8	
200PGA	2" FIPT with Flow Control	4	

RAIN BIRD® PEB & PESB GLOBE VALVE

Part No.	Description	Case Qty	Price
100PEB	1" FIPT with Flow Control	10	
150PEB	1-1/2" FIPT with Flow Control	8	
200PEB	2" FIPT with Flow Control	8	
300BPE	3" FIPT with Flow Control	1	
100PESB	1" FIPT with Scrubber & Flow Control	10	
150PESB	1-1/2" FIPT with Scrubber & Flow Control	8	
200PESB	2" FIPT with Scrubber & Flow Control	8	
300BPES	3" FIPT with Scrubber & Flow Control	1	

TORO® AG CONTROL VALVES

TORO® AG CENTURY (100 SERIES) GLOBE / ANGLE VALVE

Part No.	Description	Case Qty	Price
A-100P1	1" Century Valve with Flow Control	24	
A-100P1.5	1-1/2" Century Valve with Flow Control	12	
A-100P2	2" Century Valve with Flow Control	4	
A-100P3	3" Century Valve with Flow Control	4	

TORO® AG ULTRA-FLOW (700 SERIES) GLOBE VALVE

Part No.	Description	Case Qty	Price
A-700B-.75	3/4" Ultra-Flow Valve with Flow Control	12	
A-700-1	1" Ultra-Flow Valve with Flow Control	24	
A-700-1.5	1-1/2" Ultra-Flow Valve with Flow Control	12	
A-700-2	2" Ultra-Flow Valve with Flow Control	8	

CONTROL ZONE KIT ASSEMBLY

3/4" DRIP ZONE ASSEMBLY

Part No.	Description	Price
XCZ075PRF	3/4" Ball Valve, 155 Mesh "Y" Filter, 3/4" Solenoid Valve, 20 PSI Regulator, Flow Range .2 - 5 GPM	



NELSON 800 SERIES CONTROL VALVES



Nelson 800 Series Valves are available in a variety of configurations for all types of irrigation systems. They have a barrel style design that minimizes friction losses and allows high flow rates. Valve body sizes 2", 3", and 4" are constructed of anodized aluminum while 6" and 8" bodies are galvanized steel, all with epoxy coated cast iron cages inside. Example valves are listed directly below. Custom design your valve by adding together the various options. Pressure reducing and sustaining pilots, rate of flow, solenoids, and filters (sections D, E, and H) are also available as separate add-on kits. Each valve is custom built to order and tested before shipment.

BASE VALVE				ACCESSORIES				
A	B		C	D		E		H
Size / Material	Connection Style & Hardware		Operating Pressure	Pressure / Flow Control		On / Off Mode		Filter
Aluminum	Wafer Style			None		Manual		
A2" Aluminum -	B9	(No Studs) Includes Manual Selector & Mounting Bracket Kits	C1	10-50 PSI	D01	E1	No Solenoid	H2
					Reducing (small body pilot)		Electric Solenoid DC (voltage, orifice diameter)	
	B10	(4 studs, 8 nuts) Includes Manual Selector & Mounting Bracket Kits	C2	30-200 PSI	D11	E21	12VDC 1/16"	H3
					D12	E34	24VDC 3/64"	Internal for 2" & 3"
A3" Aluminum -	B11	Wafer for Big Gun ANSI w/ bolts 4 studs & 4 nuts (To include Manual On-Off Control specify D01)	C3	18-80 PSI	D13	DC Latching		
	B12	Wafer for Big Gun ANSI w/o bolts (To include Manual On-Off Control specify D01)			Sustaining (small body pilot)		E23	9/12VDC, 3/64"
					D15	E27	12VDC, 1/16"	
					D16	E28	12-50V, 11/128"	
Cast Iron	Threaded			Rate-of-Flow		AC (voltage, orifice diameter)		
A2" Cast Iron -	B3	(Specify NPT or BSP) Includes Manual Selector & Mounting Bracket Kits			D18	E43	24VAC (.13 AMP)	
					Sleeve Exhaust		E46	24VAC 1/16" (.43 AMP Inrush)
A3" Cast Iron -	B6	Includes Manual Selector & Mounting Bracket Kits			D6	E53	120VAC	
					Shuttle Check			
					D7	Shuttle Check Valve (Must accompany solenoid or		
Aluminum	Wafer Style			None		Manual		
A4" -	B9	(No Studs) Includes Manual Selector & Mounting Bracket Kits	C1	10-50 PSI	D01	E1	No Solenoid	H2
					Reducing (large body pilot)		Electric Solenoid DC (voltage, orifice diameter)	
	B10	(8 studs, 16 nuts) Includes Manual Selector & Mounting Bracket Kits	C2	30-200 PSI	D2	E21	12VDC 1/16"	H3
					D3	E30	24VAC 1/16"	Internal for 4"
			C3	18-80 PSI	D4	DC Latching		
					Sustaining (large body pilot)		E27	12VDC, 1/16"
					D5	E28	12-50V, 11/128"	
Cast Iron	Wafer Style				D8	AC (voltage, orifice diameter)		
A4" -	B4	(No Studs) Includes Manual Selector & Mounting Bracket Kits			D9	E40	24VAC 1/16" (.15 AMP)	
					Rate-of-Flow		E41	24VAC 1/16" (1.1 AMP)
A6" -	B5	(8 studs, 16 nuts) Includes Manual Selector & Mounting Bracket Kits			D18	E46	24VAC 1/16" (.08 AMP)	
		4" Valve			Sleeve Exhaust			
		6" Valve			D6	E50	120VAC 1/16"	
A8" -		8" Valve			Shuttle Check			
					D7	E52	120VAC 1/16" (6" & 8" Valve Only)	
					Shuttle Check Valve (Must accompany solenoid or sustaining ctrl.)			

NETAFIM™ CONTROL VALVES

Netafim™ Control Valves are available in a wide range of sizes and flow rates to cover most applications. These iron valves have a protective polyester coating that is resistant to corrosive elements. The unique design allows a straight flow pattern with low friction loss. A direct sealing diaphragm, the valves only moving part, operates by pipeline or external pressure. Sizes range from 1" to 24" with a variety of control functions and connection options. These valves are excellent for high pressure applications, drip and sprinkler irrigation systems, or for linear and center pivot control. Maximum working pressure is 230 PSI. Optional control functions include: manual, electrical, pressure reducing, pressure sustaining, remote control and flow control. Each valve is custom built to order and tested before shipping.



BASIC VALVES

Part No.	Description	Price
61B2IT-XX	2" Basic Hydraulic Control*	
61B2-TH-AN	2" Basic Angle Hydraulic Threaded	
61B4IF-XX	4" Basic Hydraulic Flange*	
61B6IFCP	6" Basic Hydraulic Flange	
61B8IFCP	8" Basic Hydraulic Flange	
61B868IF-XX	868 Basic Hydraulic Flange	
61B10IF	10" Basic Hydraulic Flange	
* Substitute XX with HP or LP.		

MANUAL VALVES

Part No.	Description	Price
61M2IT-HP	2" Manual Threaded	
61M4IF-HP	4" Manual Flange	
61M6IF-HP	6" Manual Flange	
61M868IF-HP	868 Manual Flange	
61M8IF	8" Manual Flange	
61M10IF	10" Manual Flange	

ELECTRIC VALVES-120V

Part No.	Description	Price
61EL2IT-HPCP	2" Electric Threaded	
61EL2B-ANCP	2" Angle Electric Threaded	
61EL4IFCP	4" Electric Flange	
61EL6IFCP	6" Electric Flange	
61EL8IFCP	8" Electric Flange	
61EL868IFCP	868 Electric Flange	
61EL10IF	10" Electric Flange	

MANUAL ELECTRIC VALVES

Part No.	Description	Price
61MEL2IT-HP	2" Manual Electric Threaded	
61MEL4IFCP	4" Manual Electric Flange	
61MEL6IFCP	6" Manual Electric Flange	
61MEL868IF-HP	868 Manual Electric Flange	
61MEL8IF	8" Manual Electric Flange	
61MEL10IF	10" Manual Electric Flange	

PRESSURE REDUCING VALVES-120V

Part No.	Description	Price
61PREL4IFCP-X	4" Pressure Reducing Electric Flange	
61PR4IF-X	4" Pressure Reducing Valve Flange	
61PREL6IFCP-X	6" Pressure Reducing Electric Flange	
61PR6IF-X	6" Pressure Reducing Valve Flange	
61PREL8IFCP-X	8" Pressure Reducing Electric Flange	
61PR8IF-X	8" Pressure Reducing Valve Flange	
61PREL868IFCP-X	868 Pressure Reducing Electric Flange	
61PR868IF-X	868 Pressure Reducing Valve Flange	
61PREL10IF-X	10" Pressure Reducing Electric Flange	
61PR10IF-X	10" Pressure Reducing Valve Flange	
Substitute X with Y, G or B for downstream pressure.		

PRESSURE REDUCING VALVE SPRING RANGES

Part No.	Description
1" to 4" Valves Spring Range:	Y - Yellow (7-30 PSI)
	G - Green (14-65 PSI)
	R - Red (30-90 PSI)
6" to 24" Valves Spring Range:	Y - Yellow (8-45 PSI)
	G - Green (14-90 PSI)
	R - Red (30-130 PSI)
	B - Black (100-285 PSI)

XCAD AUTOMATIC CONTROL VALVES

X-MAX VALVES

Part No.	Description	Price
XMAX6B	6"Basic Valve	
XMAX6WS	6"Electric On/Off Valve	



SMV BASIC VALVES

Part No.	Description	Price
SMV75B	3/4" NPT Threaded	
SMV1B	1" NPT Threaded	
SMV2B	2" NPT Threaded	
SMV902B	2" 90° NPT Threaded	
SMV3B	3" NPT Threaded	
SMV4B	4" Flanged	
SMV6B	6" Flanged	



SMV ELECTRIC ON/OFF

Part No.	Description	Price
SMV75WS	3/4" NPT Threaded	
SMV1WS	1" NPT Threaded	
SMV2WS	2" NPT Threaded	
SMV902WS	2" 90° NPT Threaded	
SMV3WS	3" NPT Threaded	
SMV4WS	4" Flanged	
SMV6WS	6" Flanged	



SMV DIAPHRAGM

Part No.	Description	Price
SMV75DIA	3/4" Diaphragm	
SMV1DIA	1" Diaphragm	
SMV2DIA	2" Diaphragm	
SMV3DIA	3" Diaphragm	
SMV4DIA	4" Diaphragm	
SMV6DIA	6" Diaphragm	



EDSTROM CONTROLLERS

EDSTROM COOLING CONTROLLER

Part No.	Description	Price
7400-8910-015	C-110S, 110VAC In, 24VAC Out, 1 Station	
7400-8940-015	C-440S, 110VAC In, 24VAC Out, 4 Station	



EDSTROM COOL SENSE™ - MOTION COOLING SYSTEM

The fully-automated cooling system for any cow traffic lane. Cool Sense™ is temperature and motion activated to provide a cool shower to cows in transit. The system is triggered only when the dual motion sensors detect an animal is present and the air temperature is above your specified set point.

Part No.	Description	Price
7400-8941-100	COOL SENSE SINGLE DIRECTION	



RAINMASTER CONTROLLERS

SENTAR II SERIES CONTROLLER

Part No.	Description	Price
RME6SE-T	6 Station Outdoor Controller	
RME12SE-T	12 Station Outdoor Controller	
RME18SE-T	18 Station Outdoor Controller	

Input power required: 105-130 VAC, 50/60 Hz, .5 Amp maximum, .1 Amp idle
 Output power: 24 VAC, 1.5 Amps maximum total output (36VA) 1 Amp per station or Master Valve



TORO® AG CONTROLLERS

MC-E® SERIES CONTROLLER

Part No.	Description	Price
A-MC-4E	4 Station Outdoor Controller	
A-MC-6E	6 Station Outdoor Controller	
A-MC-8E	8 Station Outdoor Controller	
A-MC-12E	12 Station Outdoor Controller	
A-MC-18E	18 Station Outdoor Controller	
A-MC-24E	24 Station Outdoor Controller	
A-MC-30E	30 Station Outdoor Controller	
A-MC-36E	36 Station Outdoor Controller	
A-MC-42E	42 Station Outdoor Controller	
A-MC-48E	48 Station Outdoor Controller	



SUPERIOR STERLING CONTROLLERS

STERLING SOLID STATE CONTROLLER

Part No.	Description	Price
STERLING-4H	4 Station Outdoor Controller w/ Heavy-Duty Transformer	
STERLING-8H	8 Station Outdoor Controller w/ Heavy-Duty Transformer	
STERLING-12H	12 Station Outdoor Controller w/ Heavy-Duty Transformer	
STERLING-18H	18 Station Outdoor Controller w/ Heavy-Duty Transformer	
STERLING-24H	24 Station Outdoor Controller w/ Heavy-Duty Transformer	
STERLING-30H	30 Station Outdoor Controller w/ Heavy-Duty Transformer	
STERLING-36H	36 Station Outdoor Controller w/ Heavy-Duty Transformer	

Note: Lightning protection also available



BERMAD CONTROLLERS

BERMAD BIC 1000 IRRIGATION CONTROLLER

Part No.	Description	Price
EXBIC121204	BIC1000 AC 12 Out / 4 In	
EXBIC121804	BIC1000 AC 18 Out / 4 In	
EXBIC122404	BIC1000 AC 24 Out / 4 In	
EXBIC123004	BIC1000 AC 30 Out / 4 In	
EXBIC123604	BIC1000 AC 36 Out / 4 In	

BERMAD BIC 1000 LIGHTNING PROTECTION CARD

Part No.	Description	Price
EXLP21600	Lightning Protection 16 Out AC	
EXLP23200	Lightning Protection 32 Out AC	



NETAFIM™ CONTROLLERS

NETAFIM™ NMC-64 IRRIGATION CONTROLLER

Part No.	Description	Price
31NMC64	NMC-64, 16 Out, 24VAC, 8 In.	
31NMC64LC	NMC-64, 16 Out, 24VAC, 8 In., LARGE	



HOSE THREAD SHUT-OFF VALVES



SINGLE METAL SHUT-OFF

05V - Rugged zinc die cast.
AS1FFM (pictured) - Heavy-duty aluminum has 45% more water flow.

Part No.	Size	Price
05V	3/4" GHT	
AS1FFM	3/4" GHT	



DOUBLE METAL "Y" SHUT-OFF

15 - Rugged zinc die cast.
AY2FFM (pictured) - Heavy-duty aluminum has 45% more water flow.

Part No.	Size	Price
15	3/4" GHT	
AY2FFM	3/4" GHT	



FOUR WAY ALUMINUM SHUT-OFF

Controls water flow to specific areas.
Extra large handles for easier on / off operation.
Has 45% more water flow than other models.

Part No.	Size	Price
AY4FFM	3/4" GHT	



SINGLE PLASTIC SHUT-OFF

Two great shut-off valves.
However AS1FF (pictured) has 45% more water flow.

Part No.	Size	Price
07V	3/4" GHT	
AS1FF	3/4" GHT	



DOUBLE PLASTIC "Y" SHUT-OFF

Two great shut-off valves.
However AY2FF (pictured) has 45% more water flow.

Part No.	Size	Price
17	3/4" GHT	
AY2FF	3/4" GHT	



FOUR WAY PLASTIC SHUT-OFF

Controls water flow to specific areas.
Extra large handles for easier on / off operation.
Has 45% more water flow than other models.

Part No.	Size	Price
AY4FF	3/4" GHT	

HOSE THREAD FULL FLOW QUICK CONNECTORS

- Connectors for quick & easy attachment & removal of hose to faucet.
- 45% More water flow compared to similar connectors.
- Durable rustproof polymer construction.



FAUCET CONNECTOR SET

Part No.	Size	Price
39QFF	3/4" MHT/FHT	



FEMALE FAUCET CONNECTOR

Part No.	Size	Price
39QFFF	3/4" MHT	



MALE FAUCET CONNECTOR

Part No.	Size	Price
39QMFF	3/4" FHT	



MALE HOSE END QUICK CONNECTORS

Part No.	Size	Price
29QMFF	3/4" MHT	

HOSE THREAD FITTINGS & TRANSITION ADAPTERS

VINYL HOSE WASHER

Part No.	Description	Bag Qty.	Price
12290014	Washer	100	
12290015	Washer with Screen	100	



HOSE THREAD SWIVEL TEE

Part No.	Description	Bag Qty.	Price
12010564	3/4" MHT x 3/4" FHT Swivel Tee	25	



MALE HOSE THREAD NIPPLE

Part No.	Description	Bag Qty.	Price
12040085	3/4" MHT x 3/4" MHT Plastic Nipple	50	



HOSE THREAD PLUG

Part No.	Description	Box Qty.	Price
HPL-6	MHT Plug, Plastic	100	



HOSE THREAD END CAPS

Part No.	Description	Pkg. Qty.	Price
750C	Plastic FHT End Cap with Vinyl Washer	100	
GHC7	Brass FHT End Cap with Vinyl Washer	50	
12060034	Auto Flushing FHT End Cap, Orange High Flow	50	
12060036	Auto Flushing FHT End Cap, White Low Flow	50	



FEMALE HOSE THREAD SWIVEL COUPLING

Part No.	Description	Box Qty.	Price
AP-110	3/4" FHT x 3/4" FHT, Plastic	50	
BA977	3/4" FHT x 3/4" FHT, Brass	100	



FEMALE PIPE THREAD TO FEMALE HOSE THREAD SWIVEL ADAPTER

Part No.	Description	Box Qty.	Price
AP-105	1/2" FIPT x 3/4" FHT, Plastic	50	
AP-106	3/4" FIPT x 3/4" FHT, Plastic	50	
BAS974	1/2" FIPT x 3/4" FHT, Brass	25	
BAS976	3/4" FIPT x 3/4" FHT, Brass	100	



MALE PIPE THREAD TO FEMALE HOSE THREAD SWIVEL ADAPTER

Part No.	Description	Box Qty.	Price
AP-112	1/2" MIPT x 3/4" FHT, Plastic	50	
AP-109	3/4" MIPT x 3/4" FHT, Plastic	50	



PIPE THREAD TO HOSE THREAD TRANSITION NIPPLE

Part No.	Description	Pkg Qty.	Price
MHA-12MP	1/2" MIPT x 3/4" MHT, Plastic	50	
MHA-34MP	3/4" MIPT x 3/4" MHT, Plastic	50	
BA776	3/4" MIPT x 3/4" MHT, Brass	25	
BA74	1/2" MIPT x 3/4" MHT, Brass	25	



HOSE THREAD X PVC SOLVENT WELD FITTINGS

Part No.	Model No.	Description	Bag Qty.	Price
12040026	3/4-FHS-WW	1/2" Socket / 3/4" Spigot x 3/4" FHS w/ Washer	50	
12040024	3/4-FHS-1-WW	3/4" Socket / 1" Spigot x 3/4" FHT w/ Washer	50	
12040003	1/2-MHA	1/2" Socket / 3/4" Spigot x 3/4" MHT	50	
12040028	3/4-MHA	3/4" Socket / 1" Spigot x 3/4" MHT	50	
12290011	1-MHA	1" Socket x 3/4" MHT	25	
12010005	1/2-90-MHA	1/2" Socket x 3/4" MHT Elbow	50	
12010002	3/4-90-MHA	3/4" Socket x 3/4" MHT Elbow	25	



LOW VOLUME SHRUB ADAPTERS

ADAPTERS TO 10-32 THREAD & 1/8" THREAD

Part No.	Description	Bag Qty.	Price
41015	Poly Adapter, 1/2" FIPT x 10-32 Self Tap Thread	25	
12500523	Poly Adapter, 1/2" FIPT x 10-32 Self-Tap Thread	50	
12500930	PVC Adapter, 1/2" FIPT x 10-32 Thread	50	
PA2020-01	PVC Adapter, 1/2" Soc x 10-32 Thread	50	
12500931	PVC Adapter, 1/2" FIPT x 1/8" FIPT	50	
PA2020-02	PVC Adapter, 1/2" Soc x 1/8" FIPT	50	
12500521	Riser Adapter, 1/2" FIPT x 1/2" MIPT x 1/4" Barb	50	



THREADED & BARBED SHUT-OFF VALVES

HOSE THREAD BALL VALVE

Part No.	Description	Bag Qty.	Price
12060017	Plastic Black Body / Black Handle	25	
12060046	Plastic Low Profile Black Body / Green Handle	25	



BARBED SHUT-OFF VALVES

Part No.	Description	Bag Qty.	Price
VAVB-06	1/4" Barb Valve (Tube .175" I.D.)	100	
45505	1/2" Shut-off Valve (Tube .520" I.D.)	25	
45515	5/8" Shut-off Valve (Tube .570" - .620" I.D.)	25	
45535	3/4" Shut-off Valve (Tube .810" - .820" I.D.)	25	
45545	1" Shut-off Valve (Tube 1.050" I.D.)	25	



BARBED DISTRIBUTION FITTINGS

.125" INSERT BARB FITTINGS (FOR .125" I.D. TUBING)

Part No.	Description	Bag Qty.	Price
12290006	1/8" Barb Coupling	100	
12500541	1/8" Barb Tee	50	



.175" INSERT BARB FITTINGS (FOR .160" I.D. TUBING)

Part No.	Description	Bag Qty.	Price
C-25	.175" Barbed Coupling	100	
3019	.175" Barbed Coupling	100	
EL-25	.175" Barbed 90° Elbow	100	
T-25	.175" Barbed Tee	100	



THREADED DISTRIBUTION ADAPTER

Part No.	Description	Bag Qty.	Price
12500492	10-32 Thread x 10-32 Thread	100	
6093	10-32 Thread x .175" Barb	100	
12500383	3/4" FHT x .175" Barb	50	
RD32605	3/4" FIPT x .175" Barb	100	



.250" INSERT BARB FITTINGS (FOR .250" I.D. TUBING)

Part No.	Description	Bag Qty.	Price
2025	.250" x .250" Barbed Coupling	100	
3020	.250" x .175" Barbed Reducer Coupling	100	



GOOF PLUGS, BUG CAPS, STAKES & ACCESSORIES

GOOF PLUGS

Part No.	Description	Bag Qty.	Price
12290034	Double End Tree of 20	5	
42325	Single End - Tree of 10	10	



BUG CAP

Part No.	Description	Bag Qty.	Price
EOCV125	.125" Green Bug Cap	100	
EOCV220	.220" Black Bug Cap	100	



STAKE ANCHORS

Part No.	Description	Bag Qty.	Price
LD16STK	7-3/4" Plastic Stake for Dripline or Techline®	25	
12290041	8" Plastic Stake for 1/2" Tubing - Bottom Clip	25	
12290042	Micro Tubing from .167" to .350" O.D.	25	
12290043	Micro Tubing from .187" O.D.	25	
12290044	5" Plastic Stake for 1/2" Tubing - Top Clip	25	
*12290045	Wire Anchor Use on Tubing Up to 1" O.D.	-	
12500937	8" Wire Stake, Fits 1/8" - 1/2" Tube	100	
*TLS6	6" Wire Stake	25	



*Also used for anchoring landscape fabric. Sold in bag quantity only.

RISER TUBING (.30" O.D. X .16" I.D.) WITH SP-T SPIKE

Part No.	Description	Bag Qty.	Price
532	3" Riser	50	
12500969	6" Riser	25	
535	9" Riser	50	
11195029	12" Riser	25	
3018	SP-T Spike	50	



RISER STAKES

Part No.	Description	Pack Qty.	Price
3072	9" J Stake	50	
3178	13" Clip-On Riser Stake	50	
IPS0403	12" Barbed Riser Stake - 4mm Barb x 10/32 UNF Self Tapping Threads	50	
40875	12" Asta® Stake	50	



RISER STAKE ASSEMBLIES WITH CONNECTOR TUBING AND BARB

Part No.	Description	Pack Qty.	Price
3075-3708	SP-T Spike with 6" Riser and 24" Vinyl Tubing	50	
8520	J Stake or Clip-on Riser Stake with 36" PE Tubing	50	
8507	J Stake or Clip-on Riser Stake with 36" Vinyl Tubing	50	
IPS0403-36V	Stake x 10/32 Self Tapping Threads with 36" Vinyl Tubing	50	
50365	12" Asta® Stake with 24" Vinyl Tubing	50	

VINEYARD FASTENERS

VINEYARD TYES

Part No.	Description	Case Qty.	Price
AGLOK™	Universal Agricultural Fastener	500 Ft.	
GREEN-TIE™	UV Stabilized Tye	1000	
DRIPLOK™	1/2" Clip - Dripline to Trellis Wire	6000 / Ea.	
DRIPLOK™	7/8" Clip - Dripline to Trellis Wire	4000 / Ea.	
TRELLIS CLIP	Flat Strap 4" fits 12-14 Wire Sizes	500	
VINYL-TIE™	Elastic Stabilized Tye	1000 Ft	
WIREWISE™	Fence Wire Anchor	500 / Ea.	
WIRELINK™	Wire Splicer	500	
11240003	Flex Strap™ Vinyl Tree Tye-500'	1	

VINE CURL

Part No.	Description	Case Qty.	Price
11050003	3" for 0.700" O.D. Tubing	1,000	
11050013		40,000	
11050004	4" for 0.700" O.D. Tubing	1,000	
11050014		25,000	
11050005	3" for 0.830" O.D. Tubing	1,000	
11050015		25,000	
11050006	4" for 0.830" O.D. Tubing	1,000	
11050016		20,000	
11050008	4" for 0.940" O.D. Tubing	750	
11050017		15,000	

NURSERY FASTENERS

NURSERY TYES

Part No.	Description	Case Qty.	Price
3401	1/2" x 200' Economy	144	
3402	1/2" x 150' Heavy Duty 24/144	144	
3421	1" x 150' Giant 12/72	72	
3704	HT-B2 Max Tapener	10	
3708	604-E-L Staples	4800	
3910	Ring Knife Size #10	12	
3912	Ring Knife Size #12	12	

Note: Additional colors are available in 100' rolls upon special request.
Staples sold in case quantity only.

SOIL MOISTURE TENSIOLOGERS

"LT" - SOIL MOISTURE TENSIOLOGERS FOR CONTAINERS & SERVICE PUMP

Part No.	Length	Description	Price
IR-506LT	6"	Irrrometer "LT" Model	
IR-512LT	12"	Irrrometer "LT" Model	
IR-518LT	18"	Irrrometer "LT" Model	
IR-524LT	24"	Irrrometer "LT" Model	
IR-536LT	36"	Irrrometer "LT" Model	
IR-1001		Irrrometer Service Kit	

"R" - SOIL MOISTURE SENSOR (AGRICULTURE)

Part No.	Length	Description	Price
106	6"	Irrrometer "R" Model	
112	12"	Irrrometer "R" Model	
118	18"	Irrrometer "R" Model	
124	24"	Irrrometer "R" Model	
136	36"	Irrrometer "R" Model	
148	48"	Irrrometer "R" Model	



Designed for situations where tensions above 30 cb (kPa) are rarely expected. Ideal for very coarse soils and non-soil container-media or where rapidly changing soil water status needs to be observed.



For general use with row, tree, and field crops. Shorter lengths for greenhouse & pots.

SOIL MOISTURE TENSIOMETERS

"SR" MODEL - SOIL MOISTURE SENSOR (REPLACEABLE TIP)

Threaded replaceable tip for easy field repair, for general use with row, tree & field crops.

Part No.	Length	Description	Price
206	6"	Irrrometer "SR" Model	
212	12"	Irrrometer "SR" Model	
218	18"	Irrrometer "SR" Model	
224	24"	Irrrometer "SR" Model	
236	36"	Irrrometer "SR" Model	
248	48"	Irrrometer "SR" Model	
SRT		Replacement Tips	



200SS SOIL MOISTURE SENSOR (BASIC)

Part No.	Length	Description	Price
200SS-5	5'	Soil Sensor with 2 Wire Leads (20 AWG)	
200SS-10	10'	Soil Sensor with 2 Wire Leads (20 AWG)	
200SS-15	15'	Soil Sensor with 2 Wire Leads (20 AWG)	
200SS-X	No Wire	Soil Sensor without Wire Leads	



DIGITAL METER - (HAND HELD)

Part No.	Description	Price
30-KTCD-NL	Digital Readout Meter	
30-KTCD-Cable	Replacement Cable	

MONITOR & TRANSMITTER

Part No.	Description	Price
900M	Monitor Collects & Records up to 8 sensors & inputs	



SENSOR INSTALLATION TOOLS

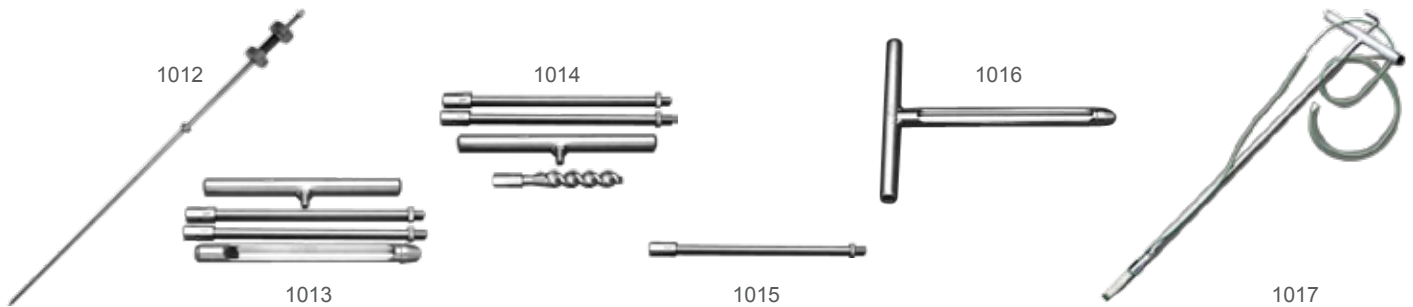

Name	Part No.	Description	Price
Slide Hammer	1012	Steel slide hammer with 7/8" (22mm) diameter x 48" (120cm) long insertion tip, calibrated every 12"	
Coring Tool Kit	1013	Nickel Plated 7/8" (22mm) soil coring tool. Comes with two 12" (30cm) extensions and handle for making up to a 36" (90cm) access hole. Can also be used for soil sampling.	
Auger Tool Kit	1014	Nickel Plated 1" (25mm) soil auger. Makes oversize hole for grout style sensor installation in hard or rocky soils. Comes with two 12" (30cm) extensions and handle for making up to a 36" (90cm) access hole.	
Extension Rod	1015	12" (30cm) extension rod for #1013 or #1014 (above) for making deeper access holes.	
Turf Coring Tool	1016	Turf style installation tool for shallow sensor installation depths, to 12" (30cm). Nickel plated 7/8" (22mm) soil coring tool with integral handle. Can also be used for soil sampling	
Sensor Insertion Tool	1017	Tee handle style tool for inserting the sensor up to 30" (76cm) into the borehole created by one of the tools shown here. Has internal ejection rod inside tube to push sensor off of tool once fully inserted into borehole.	

LIQUID FILLED PRESSURE GAUGE

2-1/2" FACE, STAINLESS STEEL

Part No.	PSI Range	Price
2141GXB15	0-15 PSI	
2141GXB30	0-30 PSI	
2141GXB60	0-60 PSI	
2141GXB100	0-100 PSI	
2141GXB160	0-160 PSI	
2141GXB300	0-300 PSI	

4" FACE, STAINLESS STEEL

Part No.	PSI Range	Price
4141GXB30	0-30 PSI	
4141GXB60	0-60 PSI	
4141GXB100	0-100 PSI	
4141GXB160	0-160 PSI	

2-1/2" FACE, BLACK ABS PLASTIC CASE

Part No.	PSI Range	Price
LFS220-30	0-30 PSI	
LFS220-60	0-60 PSI	
LFS220-100	0-100 PSI	
LFS220-160	0-160 PSI	

4" FACE, BLACK ABS PLASTIC CASE

Part No.	PSI Range	Price
LFS310-30	0-30 PSI	
LFS310-60	0-60 PSI	
LFS310-100	0-100 PSI	
LFS310-160	0-160 PSI	



PRESSURE GAUGE ACCESSORIES

ACCESSORIES

Part No.	Description	Price
PIT25	Pitot Tube	
A90917	Pitot Tube	
A90952	Silcock Adapter	
12070006	Lock on Gauge Chuck 1/4" FIPT	
13180129	Schrader Valve	
12070010	Pocket Pressure Gauge 0-50 PSI	
9438-002	Fem. Quick Connect 1/4" FIPT	
9498	Male Quick Connect 1/4" FIPT	



NELSON PRESSURE GAUGE TAP ASSEMBLY

Part No.	Description	Price
10367	Acme Tap Assembly	



EMITTER INSTALLATION TOOLS

BUG GUN INSTALLATION TOOL

Part No.	Description	Price
EMABGX	Bug Gun Installation Tool	

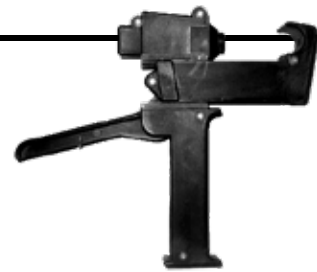

SUBMATIC TYPE EMITTER INSTALLATION TOOL

Part No.	Description	Price
IT	E2 & E4 Emitter Installation Pliers	



PUNCH TOOLS

PUNCHES

Part No.	Description	Price
2151	Yellow Punch Tool, 0.93	
2154	Black Punch Tool, .156	
000-HP125	Stik Punch for .185 Poly Tubing	
XMTOOL	Xeriman Punch Tool	
1093	Plastic Twist Punch	
TP	Plastic Twist Punch	



PUNCH TOOLS

Part No.	Description	Price
12070015	Handle Only	
12070040	Handle Only - Ejector Type	
(1) 12070028	Red Tip	
(2) 12070029	Yellow Tip	
(3) 12070026	Green Tip	
12015085	Disposable Mini Hole Punch	

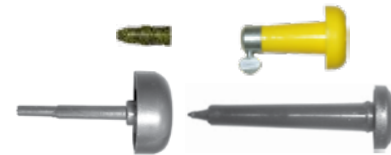

Hole Size	Emitter Shaft Size
(1) Red = .100"	.130 - .160
(2) Yellow = .125"	.165 - .190
(3) Green = .135"	.200 - .250

MIRACLE PUNCH

Part No.	Description	Price
50038	Miracle Punch	



LAYFLAT TOOLS

LAYFLAT PUNCHES

Part No.	Model No.	Description	Price
12070054	LFP-1	14mm Orange Handle Punch for 2 Step Jain® FHC(-1)-06-LS Connector	
12070055	LFP-LS-1	19mm Blue Handle Punch for Standard Jain® FHC-06(09)-LS Connector	



T-HANDLE INSTALLATION TOOLS

Part No.	Description	Price
12070013	Jain® Two Step Hex Driver for FHC(-1)-06-LS	
12070012	Jain® Single Step Hex Driver for FHC-06(09)-LS	



DRILL BITS

DRILL BITS FOR PVC PIPE

Part No.	Description	Price
12070071	1" for AS Saddles	
12070070	Drill 15/16" Hole for JAIN® 1000 Grommet	
12070069	Drill 13/16" Hole for JAIN® 700 Grommet	
12070068	Drill 9/16" Hole for JAIN® 400 Grommet	
TDBIT16.5	Drill 21/32" Hole for Netafim™ Grommet	



HOLE SAWS

HOLE SAW WITH ARBOR

Part No.	Description	Price
HSA-100	1" Hole Saw with Arbor	
HSA-1316	1-3/16" Hole Saw with Arbor	
HSA-1716	1-7/16" Hole Saw with Arbor	



OETIKER PINCERS AND CLAMPS

OETIKER PINCERS

Part No.	Description	Box Qty.	Price
14100082	Standard Jaw Pincers	6	
14100084	Long Handle Pincers	6	



OETIKER CLAMPS

Part No.	Description	Bag Qty.	Price
15500011-100	Oetiker Clamp #198 for 1/2" Poly	100	
15500017-100	Oetiker Clamp #286 for 3/4" Poly	100	
15500020-100	Oetiker Clamp #331 for 1" Poly	100	



PIPE CUTTERS

PIPE CUTTER

Part No.	Description	Price
T1004-0	1" Pipe Cutter	
T135SS	1-1/4" Pipe Cutter	
SS200	2" Pipe Cutter	



BLADE ONLY

Part No.	Description	Price
BT100SS	Stainless Blade for 1" Pipe Cutter	
BT135SS	Stainless Blade for 1-1/4" Pipe Cutter	
SSB200	Stainless Blade for 2" Pipe Cutter	

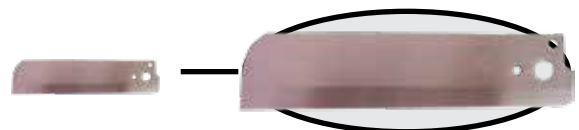

SECTION 11

Filters, Separators & Strainers

CONTENTS

- 11:3 FILTER IRRIGATION NOTES
- 11:4-25 FILTERS
 - 11:4 DROP FILTERS
 - 11:4 HOSE THREAD FILTERS
 - 11:4 JAIN SUPER FLOW FILTERS
 - 11:5 AMIAD® PLASTIC FILTERS
 - 11:6 AMIAD® STEEL FILTERS
 - 11:7 AMIAD® AUTOMATIC FILTERS
 - 11:7 AMIAD® FILTER ELEMENTS SELECTION GUIDES
 - 11:8 BANJO LINE STRAINERS
 - 11:8 BANJO POLYPROPYLENE "T" LINE STRAINERS
 - 11:9 BANJO POLYPROPYLENE "Y" STRAINERS
 - 11:9 BANJO LSQ POLYPROPYLENE LINE STRAINERS
 - 11:10 BANJO 3" "Y" STRAINERS
 - 11:10 BANJO POLYPROPYLENE MINI "T" LINE STRAINERS
 - 11:11 CLEMONS PRESSURE FINE GALVANIZED FILTERS
 - 11:11 FRESNO FLOW-GUARD GALVANIZED SCREEN 1500 SERIES
 - 11:12 JAIN® PLASTIC FILTERS
 - 11:13 JAIN® 4-E HIGH FLOW STEEL SCREEN FILTERS
 - 11:14 JAIN® 5-E HIGH FLOW STEEL SCREEN FILTERS FOR SURFACE WATER
 - 11:15 NETAFIM™ PLASTIC DISC FILTERS
 - 11:16 NETAFIM™ DISC-KLEEN FILTER BATTERIES
 - 11:17 NETAFIM™ DISC-KLEEN FILTERS
 - 11:18 NETAFIM™ AGF MEDIA FILTER BATTERIES
 - 11:19 NETAFIM™ BACKFLUSH CONTROLLERS
 - 11:20 PENTEK® FILTERS AND CARTRIDGES
 - 11:21 PENTEK® FILTERS AND CARTRIDGES
 - 11:22 LAKOS® TWISTIICLEAN FILTER
 - 11:22 VU-FLOW FILTERS
 - 11:23 VU-FLOW FILTERS
 - 11:24 YARDNEY FILTERS
 - 11:25 YARDNEY FILTERS
- 11:26-27 SAND SEPARATORS
 - 11:26 SAND SEPARATORS
 - 11:27 YARDNEY SAND SEPARATORS
- 11:28 FILTER ACCESSORIES
 - 11:28 AUTOMATIC PURGE SYSTEMS
 - 11:28 SAND & ROCK FOR SAND MEDIA FILTRATION
- 11:29 PUMP SUCTION SCREENS & CONE SCREENS
 - 11:29 SELF CLEANING PUMP SUCTION SCREEN
 - 11:29 CONE SCREENS
- 11:30-33 INTAKE STRAINERS
 - 11:30 INTAKE STRAINERS - OD TUBING CONNECTION
 - 11:31 INTAKE STRAINERS - IPS PIPE CONNECTION
 - 11:32 INTAKE STRAINERS - THREADED CONNECTION
 - 11:33 INTAKE STRAINERS - COMPANION FLANGE CONNECTION

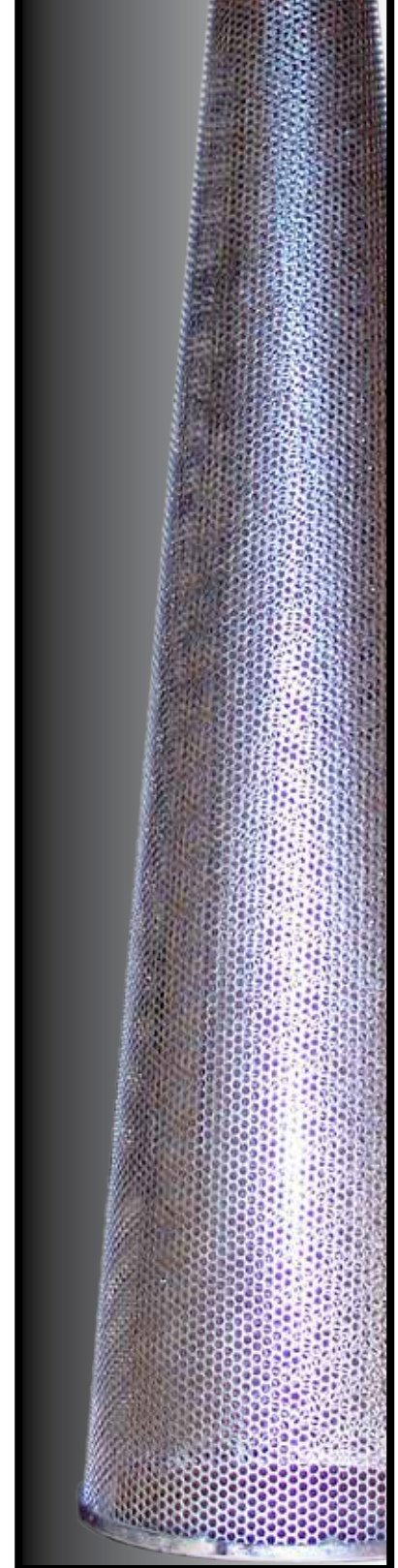

DROP FILTERS

3/4" AQUA-DROP FILTER

Threads into bottom of pivot drop for easy access.
Screen sized to reduce and / or prevent nozzles from clogging with debris.

Part No.	Description	Price
ADF075FF	3/4" Aqua-Drop Filter FIPT x FIPT	
ADF075FM	3/4" Aqua-Drop Filter FIPT x MIPT	
ADF075MF	3/4" Aqua-Drop Filter MIPT x FIPT	
ADF075MM	3/4" Aqua-Drop Filter MIPT x MIPT	

Screen Features:

- 20 mesh screen - 1/64th inch smaller than smallest nozzle available
- 5 inch screen increases surface area to reduce cleaning frequency
- 304 stainless steel screen for long life and rugged use
- Positive seal - gasket is molded into screen and sealed between fittings



3/4" EXCLUDER FILTER

Plug into the inlet side of the gooseneck prior to screwing gooseneck into pivot mainline.
Developed to prevent debris from plugging nozzles.

Part No.	Size	Description	Price
EXC34	3/4"	Insert Filter for Galvanized Gooseneck	
EXC58	5/8"	Insert Filter for PVC Gooseneck	



HOSE THREAD FILTERS

HOSE THREAD TEE FILTERS

Part No.	Description	Price
12130084	Tee Filter with 150 Mesh Stainless Steel Screen - 5 GPM Max.	
12130086	Tee Filter with 200 Mesh Stainless Steel Screen - 5 GPM Max.	
12110032	Black 150 Mesh Stainless Steel Replacement Screen	
12110033	Red 200 Mesh Stainless Steel Replacement Screen	



HOSE THREAD INLINE FILTERS

Part No.	Description	Price
12500488	Hose Thread Inline Filter with 120 Mesh Poly Screen	
12501096	Hose Thread Inline Filter Body Only	
12501097	120 Mesh Poly Replacement Screen Only	



JAIN SUPER FLOW FILTERS

Jain filters are manufactured from reinforced polypropylene material. They are designed to keep the system clear of debris downstream, and are ideal for use in landscape, nursery, and home garden applications.

JAIN SUPERFLOW FILTERS

Part No.	Model No.	Description	Price
JF-075-150	72130302	3/4" with SS Screen 150 Mesh	
JF-100-150	72130311	1" with SS Screen 150 Mesh	

Available with stainless steel screen sizes of 50, 100, 150, & 200 mesh.



AMIAD® PLASTIC FILTERS

Amiad® plastic filters are available with different filter elements to suit a variety of filtration requirements and needs. These multipurpose filters are made with different engineering plastic materials that can be suited for mechanical strength, chemical and corrosion resistance. Amiad® plastic filters feature removable filter elements for quick and easy cleaning without tools. Amiad® plastic filters may also be upgraded to semi-automatic cleaning filters by adding Brushaway and Scanaway assemblies.

AMIAD® PLASTIC FILTERS

Part No.	Description	Max GPM	Max PSI	Price
1-0703-4151-8010	Econo 3/4" Y w/Cap Flush & 155M Poly Screen	9	115	
1-1003-4151-8010	Econo 1" Y w/Cap Flush & 155M Poly Screen	9	115	
1-0701-1151-1XXX	3/4" Y Filter with Stainless Steel Screen	13	150	
1-1201-1151-7XXX	1" Y Filter with Grooved Disc Element	30	150	
1-1201-1151-1XXX	1" Y Filter with Stainless Steel Screen	30	150	
1-1501-1151-7XXX	1-1/2" Y Filter with Grooved Disc Element	45	150	
1-1501-1151-1XXX	1-1/2" Y Filter with Stainless Steel Screen	45	150	
1-1601-1151-7XXX	1-1/2" Super Y Filter with Grooved Disc Element	45	150	
1-1601-1151-1XXX	1-1/2" Super Y Filter with Stainless Steel Screen	45	150	
1-2021-2151-7XXX	2" T Filter with Grooved Disc Element	80	150	
1-2021-2151-1XXX	2" T Filter with Stainless Steel Screen	80	150	
1-2221-2151-7XXX	2" Super T Filter with Grooved Disc Element	110	150	
1-2221-2151-1XXX	2" Super T Filter with Stainless Steel Screen	110	150	
1-3021-2151-7XXX	3" T Threaded Filter with Grooved Disc Element	180	150	
1-3021-2151-1XXX	3" T Threaded Filter with Stainless Steel Screen	180	150	

XXX Screen Mesh Available: 30, 50, 75, 120, 155, 200, 300 XXX Disc Mesh Available: 60, 120, 155

AMIAD® SCANAWAY PLASTIC FILTERS

Part No.	Description	Max GPM	Max PSI	Price
1-2021-2151-5XXX	2" T Scanaway with Clog Indicator	80	150	
1-2221-2151-5XXX	2" Super T Scanaway with Clog Indicator	110	150	
1-3021-2151-5XXX	3" T Threaded Scanaway with Clog Indicator	200	150	

XXX Screen Mesh Available: 30, 50, 75, 120, 155, 200, 300
35 PSI Minimum

AMIAD® BRUSHAWAY PLASTIC FILTERS

Part No.	Description	Max GPM	Max PSI	Price
1-2021-2151-4XXX	2" T Brush Filter with Clog Indicator	80	150	
1-2221-2151-4XXX	2" Super T Brush Filter with Clog Indicator	110	150	
1-3021-2151-4XXX	3" T Threaded Brush Filter with Clog Indicator	200	150	

XXX Screen Mesh Available: 30, 50, 75



INTRO
1. ELECTRICAL
2. PUMP, ACC.
3. HOSE, PE PIPE & ACC.
4. IPS, PIP PIPE & ACC.
5. SURFACE
6. SPRINKLERS
7. TRAVELER & WHEEL MOVE
8. PIVOT
9. TURF
10. LOW VOLUME
11. FILTERS
12. INJECTION
13. HARDWARE
INDEX

AMIAD® STEEL FILTERS

Amiad® steel filters are available with different filter elements to suit a variety of filtration requirements and needs. These multipurpose filters are made of carbon steel with a high quality polyester coating. The housings can also be made of stainless steel. Amiad® steel filters feature removable filter elements for quick and easy cleaning without tools. Amiad® steel filters may also be upgraded to semi-automatic cleaning filters by adding Brushaway, and Scanaway assemblies.

AMIAD® STEEL FILTERS

Part No.	Description	Max GPM	Price
2-0200-1150-7XXX	2" Y Steel Threaded Filter w/Grooved Disc Element	110	
2-0200-1150-1XXX	2" Y Steel Threaded Filter w/Stainless Steel Screen	110	
2-0300-1110-7XXX	3" Y Steel Flg Filter with Grooved Disc Element	220	
2-0300-1110-1XXX	3" Y Steel Flg Filter with Stainless Steel Screen	220	
2-0400-1110-7XXX	4" Y Steel Flg Filter with Grooved Disc Element	330	
2-0400-1110-1XXX	4" Y Steel Flg Filter with Stainless Steel Screen	330	
2-0420-1110-0XXX	4" Super Y Steel Flg Filter w/Stainless Steel Screen	350	
2-0600-1110-0XXX	6" Compact Y Steel Flg Filter w/Stainless Steel Screen	700	
2-0800-1110-0XXX	8" Y Steel Flg Filter with Stainless Steel Screen	1200	
2-0840-1110-0XXX	8" Modular Steel Flg Filter w/Stainless Steel Screen	1200	

XXX Screen Mesh Available: 30, 50, 75, 120, 155, 200, 300

XXX Disc Mesh Available: 60, 120, 155



AMIAD® SCANAWAY STEEL FILTERS

Part No.	Description	Max GPM	Price
2-0200-1150-5XXX	2" Y Threaded Steel Scanaway Filter	110	
2-0300-1110-5XXX	3" Y Flg Steel Scanaway Filter	220	
2-0420-1110-5XXX	4" Super Y Flg Steel Scanaway Filter	350	
2-0600-1110-5XXX	6" Compact Y Flg Steel Scanaway Filter	600	
2-0800-1110-5XXX	8" Y Flg Steel Scanaway Filter	1100	
2-0840-1110-5XXX	8" Modular Flg Steel Scanaway Filter	1100	

XXX Screen Mesh Available: 30, 50, 75, 120, 155, 200, 300

35 PSI Minimum



AMIAD® BRUSHAWAY STEEL FILTERS

Part No.	Description	Max GPM	Price
2-0200-1150-4XXX	2" Y Threaded Steel Brushaway Filter	110	
2-0300-1110-4XXX	3" Y Flg Steel Brushaway Filter	220	
2-0420-1110-4XXX	4" Super Y Flg Steel Brushaway Filter	350	
2-0600-1110-4XXX	6" Compact Y Flg Steel Brushaway Filter	700	
2-0800-1110-4XXX	8" Y Flg Steel Brushaway Filter	1200	
2-0840-1110-4XXX	8" Modular Flg Steel Brushaway Filter	1200	

XXX Screen Mesh Available: 4, 6, 10, 20, 30, 50, 75



AMIAD® AUTOMATIC FILTERS



AMIAD® TAF-750E ELECTRIC FILTER 110V

Part No.	Description	Max GPM	Max PSI	Price
3-9202-2151-3400	2" Super TAF-750E Electric Filter Body (NPT)	110	115	
3-9301-2151-3400	3" TAF-750E Electric Filter Body (NPT)	220	115	

XXX Screen Mesh Available: 30, 50, 75, 120, 155, 200, 300
30 PSI Minimum

AMIAD® FILTER ELEMENTS SELECTION GUIDES

AMIAD® PLASTIC FILTER ELEMENTS SELECTION GUIDE

Type	Perforated Screen				Weave-Wire Screen									Disc Element			
	Brown	Purple	Orange	Gray	Gray	Green	Blue	White	Red	Yellow	Black	Orange	Brown	Brown	Red	Yellow	Green
Micron	3500	2500	1500	800	800	500	300	200	130	100	80	50	22	250	130	100	25
Mesh	4	6	10	20	20	30	50	75	120	155	200	300	450	60	120	155	450
XXX	350	250	150	080	080	050	030	020	013	010	008	005	002	025	013	010	002
3/4"					*	*	*	*	*	*	*	*	*				
1"					*	*	*	*	*	*	*	*	*	*	*	*	*
1-1/2"					*	*	*	*	*	*	*	*	*	*	*	*	*
1-1/2"-S					*	*	*	*	*	*	*	*	*	*	*	*	*
2"T	*	*	*	*		*	*	*	*	*	*	*	*	*	*	*	*
2"T-S	*	*	*	*		*	*	*	*	*	*	*	*	*	*	*	*
3"T	*	*	*	*		*	*	*	*	*	*	*	*	*	*	*	*
3"-S	*	*	*	*		*	*	*	*	*	*	*	*	*	*	*	*

AMIAD® STEEL FILTER ELEMENTS SELECTION GUIDE

Type	Perforated Stainless Screen Cylinder				Stainless Steel Screen								Grooved Discs *		
	Brown	Purple	Orange	Gray	Green	Blue	White	Red	Yellow	Black	Orange	Brown	Red	Yellow	
Micron	3500	2500	1500	800	500	300	200	130	100	80	50 **	250	130	100	
Mesh	4	6	10	20	30	50	75	120	155	200	300	60	120	155	
XXX	350	250	150	080	050	030	020	013	010	008	005	025	013	010	

* Discs are available for 2" - 4" filters only.

** 50 Micron screens are available for 2" - 3" steel only.

INTRODUCTION
 1. ELECTRICAL
 2. PUMP ACC.
 3. HOSE, PE PIPE & ACC.
 4. IPS, PIP PIPE & ACC.
 5. SURFACE
 6. SPRINKLERS
 7. TRAVELER & WHEEL MOVE
 8. PIVOT
 9. TURF
 10. LOW VOLUME
 11. FILTERS
 12. INJECTION
 13. HARDWARE
 INDEX

EXTERNAL LINE FILTERS

Part No.	Description	Price
14591	External Filter 1/4"M x 1/4"M	



BANJO LINE STRAINERS

STANDARD MESH & DATA (FOR GENERAL USE ONLY)

Mesh	Microns	Wire Diameter	Opening	% Open Area
6	3360	.035	.132	62.7
8	2380	.028	.097	60.2
10	2000	.025	.075	56.3
12	1680	.023	.060	51.8
16	1190	.018	.044	50.7
20	841	.016	.034	46.2
30	595	.012	.021	40.8
40	446	.012	.021	36.0
50	297	.009	.011	30.3
80	177	.0055	.007	31.4
100	149	.0045	.005	30.3
120	116	.0037	.0046	30.5

2" POLY RIBBED SCREEN COLOR CHART

Mesh Size	Rib Color
6 Mesh	White
12 Mesh	Black
20 Mesh	Beige
30 Mesh	Yellow
40 Mesh	Brown
50 Mesh	Red
80 Mesh	Blue
100 Mesh	Green
120 Mesh	Black

BANJO POLYPROPYLENE "T" LINE STRAINERS

3/4" & 1" POLY "T" STRAINERS

Part No.	Size	Description	Price
LST075-16	3/4" x 3/4"	Strainer - 16 Mesh S.S. Screen	
LST075-30	3/4" x 3/4"	Strainer - 30 Mesh S.S. Screen	
LST075-50	3/4" x 3/4"	Strainer - 50 Mesh S.S. Screen	
LST075-80	3/4" x 3/4"	Strainer - 80 Mesh S.S. Screen	
LST075-100	3/4" x 3/4"	Strainer - 100 Mesh S.S. Screen	
LST100-16	1" x 1"	Strainer - 16 Mesh S.S. Screen	
LST100-30	1" x 1"	Strainer - 30 Mesh S.S. Screen	
LST100-50	1" x 1"	Strainer - 50 Mesh S.S. Screen	
LST100-80	1" x 1"	Strainer - 80 Mesh S.S. Screen	
LST100-100	1" x 1"	Strainer - 100 Mesh S.S. Screen	

Features:

- Heavy-duty glass reinforced polypropylene.
- Clean-out plug.
- 304 Stainless steel reinforced screens.
- EPDM gaskets standard. FKM (viton type) available.
- 150 PSI at 70°F.



1-1/4" & 1-1/2" POLY "T" STRAINERS

Part No.	Size	Description	Price
LST125-16	1-1/4" x 1-1/4"	Strainer - 16 Mesh S.S. Screen	
LST125-30	1-1/4" x 1-1/4"	Strainer - 30 Mesh S.S. Screen	
LST125-50	1-1/4" x 1-1/4"	Strainer - 50 Mesh S.S. Screen	
LST125-80	1-1/4" x 1-1/4"	Strainer - 80 Mesh S.S. Screen	
LST125-100	1-1/4" x 1-1/4"	Strainer - 100 Mesh S.S. Screen	
LST150-16	1-1/2" x 1-1/2"	Strainer - 16 Mesh S.S. Screen	
LST150-30	1-1/2" x 1-1/2"	Strainer - 30 Mesh S.S. Screen	
LST150-50	1-1/2" x 1-1/2"	Strainer - 50 Mesh S.S. Screen	
LST150-80	1-1/2" x 1-1/2"	Strainer - 80 Mesh S.S. Screen	
LST150-100	1-1/2" x 1-1/2"	Strainer - 100 Mesh S.S. Screen	

Features:

- Heavy-duty glass reinforced polypropylene.
- Clean-out plug.
- 304 Stainless steel reinforced screens.
- EPDM gaskets standard. FKM (viton type) available.
- 150 PSI at 70°F.



2" POLY / STAINLESS STEEL COMBO "T" STRAINERS

Part No.	Size	Description	Price
LST200-04SS	2" x 2"	Strainer - 4 Mesh S.S. Screen	
LST200-06SS	2" x 2"	Strainer - 6 Mesh S.S. Screen	
LST200-08SS	2" x 2"	Strainer - 8 Mesh S.S. Screen	
LST200-10SS	2" x 2"	Strainer - 10 Mesh S.S. Screen	
LST200-16SS	2" x 2"	Strainer - 16 Mesh S.S. Screen	
LST200-30SS	2" x 2"	Strainer - 30 Mesh S.S. Screen	
LST200-50SS	2" x 2"	Strainer - 50 Mesh S.S. Screen	
LST200-80SS	2" x 2"	Strainer - 80 Mesh S.S. Screen	
LST200-100SS	2" x 2"	Strainer - 100 Mesh S.S. Screen	

2" Features:

- 316 Stainless steel head.
- Glass reinforced polypropylene bowl.
- Clean-out plug.
- 316 Stainless steel reinforced screens.
- FKM (viton type) gaskets.
- 150 PSI at 70°F.



BANJO POLYPROPYLENE "Y" STRAINERS

1/2" THROUGH 1-1/4" WITH SS SCREEN

Part No.	Size	Description	Price
LS050-20	1/2" x 1/2"	20 Mesh S.S. Screen	
LS050-40	1/2" x 1/2"	40 Mesh S.S. Screen	
LS050-80	1/2" x 1/2"	80 Mesh S.S. Screen	
LS075-20	3/4" x 3/4"	20 Mesh S.S. Screen	
LS075-40	3/4" x 3/4"	40 Mesh S.S. Screen	
LS075-80	3/4" x 3/4"	80 Mesh S.S. Screen	
LS100-20	1" x 1"	20 Mesh S.S. Screen	
LS100-40	1" x 1"	40 Mesh S.S. Screen	
LS100-80	1" x 1"	80 Mesh S.S. Screen	
LS125-20	1-1/4" x 1-1/4"	20 Mesh S.S. Screen	
LS125-40	1-1/4" x 1-1/4"	40 Mesh S.S. Screen	
LS125-80	1-1/4" x 1-1/4"	80 Mesh S.S. Screen	

Features:

- Precision molded construction.
- Corrosion resistant.
- Lightweight.
- Fiberglass reinforced.
- Easy grip end cap.
- Poly ribbed 316 stainless steel screen.
- EPDM gaskets FKM (viton type) available.
- Heavy duty end cap threads.
- 1/2"-1-1/4" 75 PSI Maximum.
- 1-1/2" - 2" 150 PSI Maximum.
- Clean-out plug.
- FNPT x FNPT.



1-1/2" THROUGH 2" POLY RIBBED WITH 316 SS SCREEN

Part No.	Size	Description	Price
LS150-06	1-1/2" x 1-1/2"	6 Mesh All Poly Screen	
LS150-12	1-1/2" x 1-1/2"	12 Mesh S.S. Screen	
LS150-20	1-1/2" x 1-1/2"	20 Mesh S.S. Screen	
LS150-30	1-1/2" x 1-1/2"	30 Mesh S.S. Screen	
LS150-50	1-1/2" x 1-1/2"	50 Mesh S.S. Screen	
LS150-80	1-1/2" x 1-1/2"	80 Mesh S.S. Screen	
LS150-120	1-1/2" x 1-1/2"	120 Mesh S.S. Screen	
LS200-06	2" x 2"	6 Mesh All Poly Screen	
LS200-12	2" x 2"	12 Mesh S.S. Screen	
LS200-20	2" x 2"	20 Mesh S.S. Screen	
LS200-30	2" x 2"	30 Mesh S.S. Screen	
LS200-50	2" x 2"	50 Mesh S.S. Screen	
LS200-80	2" x 2"	80 Mesh S.S. Screen	
LS200-100	2" x 2"	100 Mesh S.S. Screen	
LS200-120	2" x 2"	120 Mesh S.S. Screen	

1-1/2" & 2" WITH ALL POLY SCREENS

Part No.	Size	Description	Price
LS150-12P	1-1/2" x 1-1/2"	12 Mesh All Poly Screen	
LS150-20P	1-1/2" x 1-1/2"	20 Mesh All Poly Screen	
LS150-50P	1-1/2" x 1-1/2"	50 Mesh All Poly Screen	
LS200-12P	2" x 2"	12 Mesh All Poly Screen	
LS200-20P	2" x 2"	20 Mesh All Poly Screen	
LS200-50P	2" x 2"	50 Mesh All Poly Screen	

BANJO LSQ POLYPROPYLENE LINE STRAINERS

LSQ SERIES POLY STRAINERS

Part No.	Size	Description	Price
LSQ150-06	1-1/2" x 1-1/2"	All Poly 6 Mesh Screen	
LSQ150-12	1-1/2" x 1-1/2"	12 Mesh Screen	
LSQ150-20	1-1/2" x 1-1/2"	20 Mesh Screen	
LSQ150-30	1-1/2" x 1-1/2"	30 Mesh Screen	
LSQ150-50	1-1/2" x 1-1/2"	50 Mesh Screen	
LSQ150-80	1-1/2" x 1-1/2"	80 Mesh Screen	
LSQ150-120	1-1/2" x 1-1/2"	120 Mesh Screen	
LSQ200-06	2" x 2"	All Poly 6 Mesh Screen	
LSQ200-12	2" x 2"	12 Mesh Screen	
LSQ200-20	2" x 2"	20 Mesh Screen	
LSQ200-30	2" x 2"	30 Mesh Screen	
LSQ200-50	2" x 2"	50 Mesh Screen	
LSQ200-80	2" x 2"	80 Mesh Screen	
LSQ200-120	2" x 2"	120 Mesh Screen	

Features:

- Precision molded in glass reinforced polypropylene.
- Cam lever configuration for easy access for cleaning & servicing.
- 3/4" plug in cam lever cap for attaching ball valve for draining or back flushing.
- Poly ribbed stainless steel screen.
- EPDM lathe cut gasket.
- FKM (viton type) gaskets available.
- 75 PSI maximum.



INTRO
1. ELECTRICAL
2. PUMP ACC.
3. HOSE, PE PIPE & ACC.
4. IPS, PIP PIPE & ACC.
5. SURFACE
6. SPRINKLERS
7. TRAVELER & WHEEL MOVE
8. PIVOT
9. TURF
10. LOW VOLUME
11. FILTERS
12. INJECTION
13. HARDWARE
INDEX

BANJO 3" "Y" STRAINERS

3" POLY "Y" STRAINERS

Part No.	Description	Price
LSM300-04	3" Line Strainer with 4 Mesh Screen	
LSM300-06	3" Line Strainer with 6 Mesh Screen	
LSM300-08	3" Line Strainer with 8 Mesh Screen	
LSM300-12	3" Line Strainer with 12 Mesh Screen	
LSM300-20	3" Line Strainer with 20 Mesh Screen	
LSM300-50	3" Line Strainer with 50 Mesh Screen	
M300MPT	3" Flange x 3" Male Thread	
M300FPT	3" Flange x 3" Female NPT Thread	
FC300	300 Series Worm Screw Clamp	
300G	300 Series EPDM Gasket	

*Warning: 3" Polypropylene "Y" Strainer to be used on suction side or non-pressure side in all applications.

Features:

- Lightweight.
- High volume.
- Constructed of glass filled polypropylene.
- 1/2" drain plug in bottom of cap.
- Reinforced stainless steel screen.
- 3" FNPT threads.
- 75 PSI maximum.*



3" 316 STAINLESS STEEL "Y" STRAINERS

Part No.	Description	Price
LSS300-BC	S.S. Line Strainer Body, Cap & Gasket	
*LSS3XX	Stainless Steel Screen	
LSS300-B	Stainless Steel Line Strainer Body	
LSS300-C	Stainless Steel Line Strainer Cap	
LSS300-S	Screen Seal	
LSS300-SV	Screen Seal FKM (Viton Type)	
LSS300-G	Replacement Gasket-Cap EPDM	
LSS300-GV	Replacement Gasket-Cap FKM (Viton Type)	
LSS300-H	Handle/Clamp Assembly	

*Screens sold separately:

XX = 06 6Mesh, 08 8Mesh, 12 12 Mesh, 20 20Mesh, 30 30Mesh, 50 50Mesh

Features:

- EPDM gaskets standard.
- FKM (viton type) available.
- Corrosion resistant.
- 200 PSI maximum.
- Clean-out plug.
- Stainless steel screens sold separately.



BANJO POLYPROPYLENE MINI "T" LINE STRAINERS

1/2" MINI T-STRAINER WITH CLEAR BOWL

Part No.	Size	Description	Price
LSTM050-30C	1/2" x 1/2"	30 Mesh Screen	
LSTM050-50C	1/2" x 1/2"	50 Mesh Screen	
LSTM050-80C	1/2" x 1/2"	80 Mesh Screen	
LSTM050-100C	1/2" x 1/2"	100 Mesh Screen	

Features:

- Heavy-duty glass reinforced polypropylene.
- Clear or black polypropylene bowl.
- Polypropylene ribbed 304 stainless steel screens.
- EPDM gaskets standard. FKM (viton type) available.
- Clear Bowl Max 100 PSI at 70°F.
- Black Bowl Max 150 PSI at 70°F.

3/4" MINI T-STRAINER WITH CLEAR BOWL

Part No.	Size	Description	Price
LSTM075-30C	3/4" x 3/4"	30 Mesh Screen	
LSTM075-50C	3/4" x 3/4"	50 Mesh Screen	
LSTM075-80C	3/4" x 3/4"	80 Mesh Screen	
LSTM075-100C	3/4" x 3/4"	100 Mesh Screen	

1/2" MINI T-STRAINER WITH BLACK BOWL

Part No.	Size	Description	Price
LSTM050-30	1/2" x 1/2"	30 Mesh Screen	
LSTM050-50	1/2" x 1/2"	50 Mesh Screen	
LSTM050-80	1/2" x 1/2"	80 Mesh Screen	
LSTM050-100	1/2" x 1/2"	100 Mesh Screen	

3/4" MINI T-STRAINER WITH BLACK BOWL

Part No.	Size	Description	Price
LSTM075-30	3/4" x 3/4"	30 Mesh Screen	
LSTM075-50	3/4" x 3/4"	50 Mesh Screen	
LSTM075-80	3/4" x 3/4"	80 Mesh Screen	
LSTM075-100	3/4" x 3/4"	100 Mesh Screen	



CLEMONS PRESSURE FINE GALVANIZED FILTERS

HIGH FLOW STEEL FILTERS

Galvanized Body - Perforated Stainless Screen (1/32" - .031") - Plain End or Flange						
GPM	Size	Weight Lbs.	Part No. Plain End	Price	Part No. Flanged End	Price
275	4"	70	275A		275AF	
475	6"	130	475A		475AF	
700	8"	170	700A		700AF	
1,200	8"-10"	250	1200A		1200AF	
2,000	12"	412	2000A		2000AF	

Add an "F" to the part number for flanged ends with 2" half coupler, 1" drain coupler and 2 gauge ports. Specify end feed or center feed.



24 Gage Stainless Steel Screen
 3/64" - .045" Protects pivots and other systems
 3/32" - .094" Protects pivots and other systems
 2000A Model Filter Available Only In .045" & .094 Perf (20 & 24 Ga in .094")

New 24 Gage Perforated Sizes
 1/32" - .031" Protects pivots and other systems
 1/8" - .125" Coarse system protection
 1/4" - .250" Coarse system protection
 *NEW 1200 Filter Only Available in 20ga 3/32"

FRESNO FLOW-GUARD GALVANIZED SCREEN 1500 SERIES

8"/1200 GPM WITH 1/16" SCREEN

Part No.	Inlet	Outlet	Price
P3821-01	Victaulic	Victaulic	
P3821-02	Flange	Flange	
P3821-03	Plain End	Plain End	
P3821-04	Ringlock Male	Ringlock Bell	

8"/1200 GPM WITH 3/32" SCREEN

Part No.	Inlet	Outlet	Price
P3821-21	Victaulic	Victaulic	
P3821-22	Flange	Flange	
P3821-23	Plain End	Plain End	
P3821-24	Ringlock Male	Ringlock Bell	

8"/1200 GPM WITH 3/32" SCREEN CENTER FEED

Part No.	Inlet	Outlet	Price
P3821-47	Victaulic	Victaulic	
P3821-48	Flange	Flange	
P3821-49	Plain End	Plain End	
P3821-50	Ringlock Male	Ringlock Bell	

8"/1200 GPM WITH 1/16" SCREEN CENTER FEED WITH LEGS

Part No.	Inlet	Outlet	Price
P0074-60	Ringlock Male	Ringlock Bell	

8"/1200 GPM WITH 3/32" SCREEN CENTER FEED WITH LEGS

Part No.	Inlet	Outlet	Price
P0073-82	Ringlock Male	Ringlock Bell	

LEG KIT

Part No.	Description	Price
P9093-02	Pivot Filter Leg Kit	

8"/1750 GPM WITH 1/16" SCREEN

Part No.	Inlet	Outlet	Price
P3850-01	Victaulic	Victaulic	
P3850-02	Flange	Flange	
P3850-03	Plain End	Plain End	
P3850-04	Ringlock Male	Ringlock Bell	

8"/1750 GPM WITH 3/32" SCREEN

Part No.	Inlet	Outlet	Price
P3850-11	Victaulic	Victaulic	
P3850-12	Flange	Flange	
P3850-13	Plain End	Plain End	
P3850-14	Ringlock Male	Ringlock Bell	



Note: 1750 GPM filters use two screens each.

INTRO
 1. ELECTRICAL
 2. PUMP ACC.
 3. HOSE, PE PIPE & ACC.
 4. IPS, PIP PIPE & ACC.
 5. SURFACE
 6. SPRINKLERS
 7. TRAVELER & WHEEL MOVE
 8. PIVOT
 9. TURF
 10. LOW VOLUME
 11. FILTERS
 12. INJECTION
 13. HARDWARE
 INDEX

JAIN® PLASTIC FILTERS

3/4" 4-EH SERIES PLASTIC FILTER (MIPT) W/ FLUSH & BALL VALVE

Part No.	Model	Max Flow GPM	Screen Mesh	Max PSI	Price
72130118	4EH-3/4B-30	9	30	150	
72130119	4EH-3/4B-50	9	50	150	
72130115	4EH-3/4B-100	9	100	150	
72130116	4EH-3/4B-150	9	150	150	
72130117	4EH-3/4B-200	9	200	150	

1" 4-EH SERIES PLASTIC FILTER (MIPT) W/ FLUSH & BALL VALVE

Part No.	Model	Max Flow GPM	Screen Mesh	Max PSI	Price
72130201	4EH-1B-30	18	30	150	
72130203	4EH-1B-50	18	50	150	
72130205	4EH-1B-100	18	100	150	
72130207	4EH-1B-150	18	150	150	
72130209	4EH-1B-200	18	200	150	

1-1/2" 4-EH SERIES PLASTIC FILTER (MIPT) W/ FLUSH & BALL VALVE

Part No.	Model	Max Flow GPM	Screen Mesh	Max PSI	Price
72130093	4EH-1-1/2-30	55	30	150	
72130094	4EH-1-1/2-50	55	50	150	
72130090	4EH-1-1/2-100	55	100	150	
72130091	4EH-1-1/2-150	55	150	150	
72130092	4EH-1-1/2-200	55	200	150	

2" 4-EH SERIES PLASTIC FILTER (MIPT) W/ FLUSH & BALL VALVE

Part No.	Model	Max Flow GPM	Screen Mesh	Max PSI	Price
72130108	4EH-2P-30	110	30	150	
72130109	4EH-2P-50	110	50	150	
72130105	4EH-2P-100	110	100	150	
72130106	4EH-2P-150	110	150	150	
72130107	4EH-2P-200	110	200	150	

3/4" 4-E SERIES PLASTIC FILTER (MIPT) W/ FLUSH & BALL VALVE

Part No.	Model	Max Flow GPM	Screen Mesh	Max PSI	Price
72130079	4E-3/4B-30	9	30	80	
72130080	4E-3/4B-50	9	50	80	
72130076	4E-3/4B-100	9	100	80	
72130077	4E-3/4B-150	9	150	80	
72130078	4E-3/4B-200	9	200	80	

1" 4-E SERIES PLASTIC FILTER (MIPT) W/ FLUSH & BALL VALVE

Part No.	Model	Max Flow GPM	Screen Mesh	Max PSI	Price
72130181	4E-1BN-30	18	30	80	
72130183	4E-1BN-50	18	50	80	
72130185	4E-1BN-100	18	100	80	
72130187	4E-1BN-150	18	150	80	
72130189	4E-1BN-200	18	200	80	

1-1/2" 5-E SERIES PLASTIC FILTER (MIPT) W/ FLUSH & BALL VALVE (SURFACE WATER)

Part No.	Model	Max Flow GPM	Screen Mesh	Max PSI	Price
13170009	5E-40-30	40	30	150	
13170007	5E-40-50	40	50	150	
13170008	5E-40-100	40	100	150	
13170004	5E-40-150	40	150	150	
13170005	5E-40-200	40	200	150	

These Spin Clean® filters are unique in that incoming water is forced through a directional nozzle plate onto the inside of the all stainless steel filter screen. This centrifugal control of the contaminated water helps prevent debris build up on the filter screen by constantly rotating the particles and forcing them toward the debris holding basin at the bottom of the filter. By opening the flush valve periodically, the particles can be removed, or the 4E can be made self cleaning by constantly bleeding the contaminates through the flush valve which has been set slightly open.



JAIN® 4-E HIGH FLOW STEEL SCREEN FILTERS

2" 4-E SERIES FLANGED STEEL FILTER

Part No.	Model	Max Flow GPM	Screen Mesh	Price
13150027	4E-2-30F	103	30	
13150029	4E-2-50F	103	50	
13150013	4E-2-100F	103	100	
13150017	4E-2-150F	103	150	
13150022	4E-2-200F	103	200	

Features:

- No moving parts.
- Unique Spin Clean® action helps keep the screen clean.
- All welded steel housing.
- Scotchkote™ #306 fusion bond epoxy coating.
- Bonded three layer stainless steel screen.
- No backwashing down time.
- Easy screen accessibility.
- 150 PSI maximum operating pressure.
- Includes pressure check device & air vent.

3" 4-E SERIES FLANGED STEEL FILTER

Part No.	Model	Max Flow GPM	Screen Mesh	Price
13150045	4E-3-30F	210	30	
13150047	4E-3-50F	210	50	
13150032	4E-3-100F	210	100	
13150037	4E-3-150F	210	150	
13150041	4E-3-200F	210	200	

4" 4-E SERIES FLANGED STEEL FILTER

Part No.	Model	Max Flow GPM	Screen Mesh	Price
13150062	4E-4-30F	365	30	
13150064	4E-4-50F	365	50	
13150052	4E-4-100F	365	100	
13150056	4E-4-150F	365	150	
13150059	4E-4-200F	365	200	



Note: 2", 3" and 4" 4-E Series Filters are available for order with grooved ends. Please Call for pricing and availability.

6" 4-E SERIES FLANGED STEEL FILTER

Part No.	Model	Max Flow GPM	Screen Mesh	Price
13150072	4E-6-30F	550	30	
13150073	4E-6-50F	550	50	
13150067	4E-6-100F	550	100	
13150069	4E-6-150F	550	150	
13150071	4E-6-200F	550	200	

6" 4-E SERIES HIGH FLOW FLANGED STEEL FILTER

Part No.	Model	Max Flow GPM	Screen Mesh	Price
13150078	4E-6HF-30F	1000	30	
13150079	4E-6HF-50F	1000	50	
13150075	4E-6HF-100F	1000	100	
13150076	4E-6HF-150F	1000	150	
13150077	4E-6HF-200F	1000	200	

8" 4-E SERIES FLANGED STEEL FILTER

Part No.	Model	Max Flow GPM	Screen Mesh	Price
13150083	4E-8-30F	1300	30	
13150084	4E-8-50F	1300	50	
13150080	4E-8-100F	1300	100	
13150081	4E-8-150F	1300	150	
13150082	4E-8-200F	1300	200	

10" 4-E SERIES FLANGED STEEL FILTER

Part No.	Model	Max Flow GPM	Screen Mesh	Price
13150004	4E-10-30F	2200	30	
13150005	4E-10-50F	2200	50	
13150001	4E-10-100F	2200	100	
13150002	4E-10-150F	2200	150	
13150003	4E-10-200F	2200	200	

JAIN® 5-E HIGH FLOW STEEL SCREEN FILTERS FOR SURFACE WATER

3" 5-E SERIES FLANGED STEEL FILTER

Part No.	Model	Max Flow GPM	Screen Mesh	Price
13170040	5E-130-30	140	30	
13170041	5E-130-50	140	50	
13170042	5E-130-100	140	100	
13170043	5E-130-150	140	150	
13170044	5E-130-200	140	200	

Features:

- Designed for use on surface water: canals, reservoirs, rivers or ponds.
- Low installation costs.
- Unique Spin Clean® action helps keep the screen clean.
- No moving parts.
- No backwashing down time.
- All 304 stainless steel housing.
- Low maintenance.
- Laminated 316 stainless steel screen.
- Easy screen accessibility.
- 150 PSI maximum operating pressure.

4" 5-E SERIES FLANGED STEEL FILTER

Part No.	Model	Max Flow GPM	Screen Mesh	Price
13170045	5E-225-30	250	30	
13170046	5E-225-50	250	50	
13170047	5E-225-100	250	100	
13170048	5E-225-150	250	150	
13170049	5E-225-200	250	200	

6" 5-E SERIES FLANGED STEEL FILTER

Part No.	Model	Max Flow GPM	Screen Mesh	Price
13170050	5E-350-30	350	30	
13170051	5E-350-50	350	50	
13170052	5E-350-100	350	100	
13170053	5E-350-150	350	150	
13170054	5E-350-200	350	200	



6" 5-E SERIES HIGH FLOW FLANGED STEEL FILTER

Part No.	Model	Max Flow GPM	Screen Mesh	Price
13170055	5E-550-30	550	30	
13170056	5E-550-50	550	50	
13170057	5E-550-100	550	100	
13170058	5E-550-150	550	150	
13170059	5E-550-200	550	200	

8" 5-E SERIES FLANGED STEEL FILTER

Part No.	Model	Max Flow GPM	Screen Mesh	Price
13170060	5E-950-30	950	30	
13170061	5E-950-50	950	50	
13170062	5E-950-100	950	100	
13170063	5E-950-150	950	150	
13170064	5E-950-200	950	200	

8" 5-E SERIES HIGH FLOW FLANGED STEEL FILTER

Part No.	Model	Max Flow GPM	Screen Mesh	Price
13170065	5E-1300-30	1300	30	
13170066	5E-1300-50	1300	50	
13170067	5E-1300-100	1300	100	
13170068	5E-1300-150	1300	150	
13170069	5E-1300-200	1300	200	

NETAFIM™ PLASTIC DISC FILTERS

NETAFIM™ MESH TO MICRON EQUIVALENT

Mesh	Micron	Color
040	400	Blue
080	200	Yellow
120	130	Red
140	100	Black
200	70	Orange



MANUAL DISC FILTERS

Part No.	Item	Description	Flow Range (GPM)	Max (PSI)	Price
25A45-XXX	1	3/4" Manual Disc Filter	1-12	140	
25A47-XXX	2	1" Manual Disc Filter	5-26	140	
25A48-XXX	3	1" Super Manual Disc Filter	10-35	140	
25A15-XXX	4	1-1/2" Manual Disc Filter	10-35	140	
25A17-XXX	5	1-1/2" Super Manual Disc Filter	10-52	140	
25A30-XXX	6	2" Dual Manual Disc Filter	40-120	174	
25A2DL-XXX	7	2" Dual Lite Manual Disc Filter	40-110	115	
25A3TL-XXXF	8	3" Twin Lite Manual Disc Filter	80-220	115	
25A53-XXXG	9	3" Angle Grooved Manual Disc Filter	80-220	140	
25A53-XXXF	9A	3" Angle Flanged Manual Disc Filter	80-200	140	
25A78-XXXF	10	4" Twin Flanged Manual Disc Filter	160-450	140	
25A80-XXXF		6" Twin Flanged Manual Disc Filter	200-600	140	

Substitute XXX for proper mesh size - 040, 080, 120, 140, & 200 are available.
200 Mesh not available with 3/4" size.

MANUAL DISC FILTER SPECIFICATIONS

Item	1	2	3	4	5	6	7
Filtering Surface Area	24.8In. ²	48.91In. ²	77.78In. ²	49In. ²	77.8In. ²	148In. ²	148In. ²
Filtering Volume	5.8In. ³	26.8In. ³	36.1In. ³	26.8In. ³	36.1In. ³	75In. ³	75In. ³
Length	8-1/16"	8-7/8"	13-11/16"	8-25/32"	14-1/16"	18-5/16"	19-13/32"
Width	9-5/8"	5-1/8"	5-1/8"	5-1/8"	5-1/8"	7-7/8"	5-1/8"
Weight	.8Lbs.	2.4Lbs.	3.13Lbs.	2.9Lbs.	3.32Lbs.	11Lbs.	13.2Lbs.

Item	8	9	10	11	12	13
Filtering Surface Area	291In. ²	291In. ²	287In. ²	287In. ²	574In. ²	574In. ²
Filtering Volume	150In. ³	150In. ³	54In. ³	54In. ³	108In. ³	108In. ³
Length	35.3"	35.3"	25-7/32"	25-7/32"	47"	47"
Width	11-13/16"	11-13/16"	11-13/16"	11-13/16"	17-17/32"	17-17/32"
Weight	25.4Lbs.	26.8Lbs.	26Lbs.	26Lbs.	44.7Lbs.	48Lbs.

TECHFILTER® WITH TECHLINE® CV

Part No.	Description	Flow Range	Price
00120-000121	3/4" Techfilter® w/100' .9 GPH 12" Techline® CV	1-7	
00120-000148	1" Techfilter® w/100' .9 GPH 12" Techline® CV	3-22	
00120-000161	1" Long Techfilter® w/100' .9 GPH 12" Techline® CV	8-40	
00120-000175	1-1/2" Long Techfilter® w/100' .9 GPH 12" Techline® CV	8-40	
00120-000189	2" Techfilter® w/100' .9 GPH 12" Techline® CV	14-90	



INTRO | 1. ELECTRICAL | 2. PUMP Acc. | 3. HOSE, PE PIPE & Acc. | 4. IPS, PIP Pipe & Acc. | 5. SURFACE | 6. SPRINKLERS | 7. TRAVELER & WHEEL MOVE | 8. PIVOT | 9. TURF | 10. LOW VOLUME | 11. FILTERS | 12. INJECTION | 13. HARDWARE | INDEX

NETAFIM™ DISC-KLEEN FILTER BATTERIES

2" COMPACT LP DISC-KLEEN FILTER

Includes built-in battery operated backflush controller. Maximum operating pressure 90 PSI. Standard with plastic backflush valves and digital pressure differential (PD) gauge.

Part No.	Model No.	No. of Filters	Manifold Inlet / Outlet	Flow Range (GPM)	Max (PSI)	Price
70641-007225	26LP2A1-120ACAX	1	2" TH	1-80	90	
70641-007240	26LP2A1-140ACAX	1	2" TH	1-80	90	
-	26LP2A1LF-120ACAX	1	2" TH	1-40	90	
70641-007237	26LP2A1LF-140ACAX	1	2" TH	1-40	90	

Other mesh options available.
 Minimum pressure for backflush is 30 PSI downstream.
 Standard with (4) "C" batteries.



2" LP DISC-KLEEN FILTER BATTERIES

Standard with polypropylene manifolds, plastic backflush valves and installed drain manifold. Maximum Operating Pressure 90 PSI.

Part No.	No. of Filters	Manifold Inlet / Outlet	Flow Range (GPM)	Solenoid Type	Price
26LP2PP2XXXAC	2	4" GR	50-160	24VAC	
26LP2PP2XXXDC				12VDC	
26LP2PP2XXXDCL				12VDCL	
26LP2PP3XXXAC	3	4" GR	100-240	24VAC	
26LP2PP3XXXDC				12VDC	
26LP2PP3XXXDCL				12VDCL	
26LP2PP4XXXAC	4	4" GR	150-320	24VAC	
26LP2PP4XXXDC				12VDC	
26LP2PP4XXXDCL				12VDCL	

Substitute XXX with proper mesh size.
 Minimum backflush is 30 PSI downstream - backflush controller not included. Standard with 24VAC solenoids for up to 90 PSI maximum. For higher pressure applications (91-140 PSI), specify high pressure solenoids. Drain manifold - 2" grooved.



3" LP DISC-KLEEN FILTER BATTERIES

Standard with polypropylene manifolds, plastic backflush valves, and installed drain manifold. Maximum operating pressure 90 PSI.

Part No.	No. of Filters	Manifold Inlet / Outlet	Flow Range (GPM)	Solenoid Type	Price
26LP3PP3XXXAC	3	6" GR	150-450	24VAC	
26LP3PP3XXXDC				12VDC	
26ALP3PP3XXXDCL				12VDCL	
26LP3PP4XXXAC	4	6" GR	250-600	24VAC	
26LP3PP4XXXDC				12VDC	
26LP3PP4XXXDCL				12VDCL	
26LP3PP5XXXAC	5	6" GR	350-750	24VAC	
26LP3PP5XXXDC				12VDC	
26LP3PP5XXXDCL				12VDCL	

Substitute XXX with proper mesh size.
 Minimum backflush is 30 PSI downstream - backflush controller not included. Standard with 24VAC solenoids for up to 90 PSI maximum. For higher pressure applications (91-140 PSI), specify high pressure solenoids. Drain manifold - 2" grooved.



NETAFIM™ DISC-KLEEN FILTERS

APOLLO™ DISC-KLEEN FILTERS

Part No.	Filter Size	Manifold Connection	Voltage	Price
26ASK3APP4XXX-AC	4 Unit Angle	6"	24VAC	
26ASK3APP4XXX-DC			12VDC	
26ASK3APP4XXX-DCL			12VDCL	
26ASK4APP3XXX-AC	3 Unit Twin	8"	24VAC	
26ASK4APP3XXX-DC			12VDC	
26ASK4APP3XXX-DCL			12VDCL	
26ASK4APP4XXX-AC	4 Unit Twin	10"	24VAC	
26ASK4APP4XXX-DC			12VDC	
26ASK4APP4XXX-DCL			12VDCL	
26ASK4APP5XXX-AC	5 Unit Twin	10"	24VAC	
26ASK4APP5XXX-DC			12VDC	
26ASK4APP5XXX-DCL			12VDCL	
26ASK4APP6XXX-AC	6 Unit Twin	10"	24VAC	
26ASK4APP6XXX-DC			12VDC	
26ASK4APP6XXX-DCL			12VDCL	
26ASK4APP7XXX-AC	7 Unit Twin	12"	24VAC	
26ASK4APP7XXX-DC			12VDC	
26ASK4APP7XXX-DCL			12VDCL	
26ASK4APP8XXX-AC	8 Unit Twin	12"	24VAC	
26ASK4APP8XXX-DC			12VDC	
26ASK4APP8XXX-DCL			12VDCL	

The Apollo™ Automatic Disc-Kleen Filter allows you to filter more for less. It has all the benefits of the Galaxy Filter - which has been used by growers successfully and reliably for 10 years - but with these enhanced features.

- More Filter Area
- Less Pressure Required for Cleaning
- More Portable
- More Chemical Resistance
- Less Installation Costs



Substitute XXX with proper mesh size. Refer to Mesh Micron Equivalent Chart for mesh options. Minimum pressure for backflush is 30 PSI downstream. Backflush controller not included. Standard with 24VAC solenoids for up to 90 psi maximum. For higher pressure applications (91-140 PSI), specify the High Pressure Version Drain manifold - 4" grooved.

19000 SERIES SCREEN FILTERS

Part No.	Model No.	Size	Max. Flow (GPM)	Body Material	Price
70021-002800	23SF19903-120	3"	250	Epoxy Grooved	
70021-002820	23SF19903-150				
70021-002900	23SF19904-120	4"	400	Epoxy Grooved	
70021-002920	23SF19904-150				
70021-003000	23SF19806-120	6"	700	Epoxy Grooved	
70021-003020	23SF19806-150				
70021-003220	23SF19808-120	8"	1200	Epoxy Grooved	
70021-003240	23SF19808-150				
70021-003520	23SL19803-120	3"	250	Stainless Steel Flanged	
70021-003540	23SL19803-150				
70021-003620	23SL19804-120	4"	400	Stainless Steel Flanged	
70021-003640	23SL19804-150				
70021-003420	23SL19806-120	6"	700	Stainless Steel Flanged	
70021-003440	23SL19806-150				
70021-004000	23SL19808-120	8"	1200	Stainless Steel Flanged	
70021-004020	23SL19808-150				
70021-004030	23SL19810-120	10"	1800	Stainless Steel Flanged	
-	23SL19810-150				



Other mesh options (special order): 40, 80 and 200.

INTRO | 1. ELECTRICAL | 2. PUMP ACC. | 3. HOSE, PE PIPE & ACC. | 4. IPS, PIP PIPE & ACC. | 5. SURFACE | 6. SPRINKLERS | 7. TRAVELER & WHEEL MOVE | 8. PIVOT | 9. TURF | 10. LOW VOLUME | 11. FILTERS | 12. INJECTION | 13. HARDWARE | INDEX

NETAFIM™ AGF MEDIA FILTER BATTERIES



MEDIA INFORMATION

Media Type	Mesh	Mean Effective Size (mm)	Uniformity Coefficient	Minimum Backflush
Crushed Silica 12	80-130	1.1 - 1.2	1.5	240 GPM
Standard Sand 6/20	100-140	0.9 - 1.0	1.5	240 GPM
Crushed Silica 16	155-200	0.6 - 0.7	1.5	200 GPM
US Silica 80	160-200	0.6 - 0.7	1.5	225 GPM
Crushed Silica 20	170-230	.45 - 0.5	1.4	180 GPM

AGF MEDIA FILTER BATTERIES

Standard with polypropylene manifolds and plastic backflush valves. Maximum operating pressure 85 PSI.

Part No.	Model No.	No. of Filters	Flow Range (GPM)	Solenoid Type	Manifold Inlet / Outlet	Price
70661-016200	27AGF4802PP	2	400 - 600	24VAC	6"	
70661-016201	27AGF4802PP-12DC			12VDC		
70661-016202	27AGF4802PP-12DCL			12VDCL		
70661-016400	27AGF4803PP	3	600 - 900	24VAC	6"	
70661-016401	27AGF4803PP-12DC			12VDC		
70661-016402	27AGF4803PP-12DCL			12VDCL		
70661-016500	27AGF4804PP-S	4	800 - 1,200	24VAC	8"	
70661-016501	27AGF4804PP-S12DC			12VDC		
70661-016506	27AGF4804PP-S12DCL			12VDCL		
70661-016600	27AGF4804PP-T	4	800 - 1,200	24VAC	6" x 8" x 6" Tee	
70661-016602	27AGF4804PP-T12DC			12VDC		
-	27AGF4804PP-T12DCL			12VDCL		
70661-016900	27AGF4805PP-T	5	1,000 - 1,500	24VAC	6" x 10" x 6" Tee	
70661-016903	27AGF4805PP-T12DC			12VDC		
70661-016710	27AGF4805PP-T12DCL			12VDCL		
70661-017100	27AGF4806PP-T	6	1,200 - 1,800	24VAC	6" x 10" x 6" Tee	
70661-017115	27AGF4806PP-T12DC			12VDC		
70661-017120	27AGF4806PP-T12DCL			12VDCL		
70661-017300	27AGF4807PP-T	7	1,400 - 2,100	24VAC	8" x 10" x 8" Tee	
70661-017301	27AGF4807PP-T12DC			12VDC		
-	27AGF4807PP-T12DCL			12VDCL		
70661-017500	27AGF4808PP-T	8	1,600 - 2,400	24VAC	8" x 10" x 8" Tee	
70661-017501	27AGF4808PP-T12DC			12VDC		
-	27AGF4808PP-T12DCL			12VDCL		
70661-017700	27AGF4810PP-T	10	2,000 - 3,000	24VAC	6" x 12" x 6" H	
70661-017720	27AGF4810PP-T12DC			12VDC		
70661-017810	27AGF4810PP-T12DCL			12VDCL		
-	27AGF4812PP-H	12	2,400 - 3,600	24VAC	6" x 10" x 6" H	
-	27AGF4812PP-H12DC			12VDC		
-	27AGF4812PP-H12DCL			12VDCL		
-	27AGF4815PP-H	15	3,000 - 4,500	24VAC	8" x 14" x 8" H	
-	27AGF4815PP-H12DC			12VDC		
-	27AGF4815PP-H12DCL			12VDCL		
70640-015000	27AGF48	1	Tank Only	-	4" GR	

Backflush controller not included.

Sand required per tank is 1300 LBS and is not included in the price.

Note: Refer to page 11:28 for Media.

NETAFIM™ BACKFLUSH CONTROLLERS



CONTROLLERS ONLY

Part No.	Model No.	No. of Stations	Included	Voltage	Price
00105-001400	23AXF2ACDC-D	2	PD Gauge, Transformer	24VAC/12VDC	
00105-001550	23AXF2DCL-P	2	PD, (2) 9V Lithium Batteries	12VDCL	
00105-001700	23AXF3ACDC-D	3	PD Gauge, Transformer	24VAC/12VDC/12VDCL	
00105-002300	23AXF4ACDC-D	4	PD Gauge, Transformer	24VAC/12VDC/12VDCL	
00105-004950	23AXF8ACDC-D	8	PD Gauge, Transformer	24VAC/12VDC/12VDCL	
00105-003750	23AXF12ACDCDCLD	12	PD Gauge, Transformer	24VAC/12VDC/12VDCL	

CONTROLLER INSTALLED ON DISC-KLEENS AND AGF MEDIA FILTER BATTERIES

Part No.	Model No.	No. of Stations	Included	Voltage	Price
-	23AXF2ACDC-D-I	2	PD Gauge, Transformer	24VAC/12VDC	
-	23AXF2DCL-P-I	2	PD, (2) 9V Lithium Batteries	12VDCL	
-	23AXF3ACDC-D-I	3	PD Gauge, Transformer	24VAC/12VDC/12VDCL	
-	23AXF4ACDC-D-I	4	PD Gauge, Transformer	24VAC/12VDC/12VDCL	
-	23AXF8ACDC-D-I	8	PD Gauge, Transformer	24VAC/12VDC/12VDCL	
-	23AXF12ACDC-D-I	12	PD Gauge, Transformer	24VAC/12VDC/12VDCL	

CONTROLLER WITH SOLAR PANEL KIT

Part No.	Model No.	No. of Stations	Included	Voltage	Price
00105-004450	23AXF3DCLSP	3	Controller, Solar Panel & Brkt	12VDCL	
00105-002600	23AXF4DCLSP	4	Controller, Solar Panel & Brkt	12VDCL	
00105-005220	23AXF8DCLSP	8	Controller, Solar Panel & Brkt	12VDCL	
00105-003760	23AXF12DCLSP	12	Controller, Solar Panel & Brkt	12VDCL	

PARTS

Part No.	Model No.	Description	Price
00105-003500	23SP5	Solar Panel	
00105-003600	23SP5BRKT	Solar Panel Bracket	
00105-003100	23BATT-7	Battery	
00105-003200	23GALPD	Murphy PD Gauge	

Note: For part numbers not listed, please give us a call.

INTRO
 1. ELECTRICAL
 2. PUMP ACC.
 3. HOSE, PE PIPE & ACC.
 4. IPS, PIP PIPE & ACC.
 5. SURFACE
 6. SPRINKLERS
 7. TRAVELER & WHEEL MOVE
 8. PIVOT
 9. TURF
 10. LOW VOLUME
 11. FILTERS
 12. INJECTION
 13. HARDWARE
 INDEX

PENTEK® FILTERS AND CARTRIDGES

STANDARD HOUSING FEATURES:

- Ideal for a wide range of residential, commercial and industrial applications
- 3/4" NPT inlet / outlet
- Available in 10" and 20" lengths
- Equipped with black mounting bracket cap
- #10 Filter available with either clear or opaque sump
- Maximum operating pressure 125 PSI @ 125° F
- Tested and certified by NSF International to NSF / ANSI Standard 42 for material and structural integrity requirements only

Part No.	Sump	Head	Inlet / Outlet	Length	Width	Price
150068	#10 Blue	Black	3/4" NPT	12-1/4"	5-1/8"	
150436	#10 Clear	Black	3/4" NPT	12-1/4"	5-1/8"	
150070	#20 Blue	Black	3/4" NPT	22-3/8"	5-1/8"	



STANDARD CARTRIDGE FEATURES: (2-1/2" DIA. X 9-3/4" LENGTH)

Polypropylene Cord Wound

- Economically priced
- Use for general purpose filtration
- Ideal for fine sediment reduction including sand, silt, scale & rust
- String wound design

Pleated Polyester

- Excellent for water well, institutional and light industrial applications
- 4 Sq. Ft. of Fabric in every cartridge
- Will not support bacteria growth
- Can be washed & reused several times

Part No.	Model	Medium	Construction	Micron	Mesh	GPM	Price
155187-52	CW-MF	Polypropylene	Cord Wound	30	420	5	
155214-52	CW-50	Polypropylene	Cord Wound	50	300	5	
155017-52	R30	Polyester	Pleated	30	420	12	
155038-52	R50	Polyester	Pleated	50	300	12	
155003	Cartridge Coupler used to connect 2 Cartridges for use in 20" filter						



PARTS AND ACCESSORIES FOR CARTRIDGE TYPE FILTERS

Part No.	Description	Price
150578	MC-1A Mounting Bracket Kit for 3/4" Standard Filters Includes Bracket and Screws	
150061	WB-SS Mounting Bracket Kit for Big Blue® Filters Includes Stainless Steel Bracket with Screws	
150295	SW-2 Spanner Wrench for 3/4" Standard Housing	
150296	SW-3 Spanner Wrench for 10" Big Blue® Housing	
SH144368	SW-4 Spanner Wrench for 20" Big Blue® Housing	
155003	Cartridge Coupler for Standard Cartridges	
SH144229	Cartridge Coupler for Big Blue® Cartridges	



PENTEK® FILTERS AND CARTRIDGES

BIG BLUE®/ BIG CLEAR: LARGE DIAMETER HOUSING FEATURES:

- Available in 10" and 20" lengths
- Large capacity housing designed for whole house and high-flow applications
- The high-flow cap is designed with a 1-1/4" internal port which allows for larger flow rates
- Equipped with black mounting bracket cap
- Caps are molded from polypropylene which is compatible with a broad range of chemicals
- Large capacity 4-1/2" diameter cartridges create a larger surface area for heavy-sediment applications
- Maximum operating pressure is 100 PSI for the 10" length and 90 PSI for the 20" length at 100°F

BIG BLUE®

LARGE DIAMETER HOUSING FEATURES:

- Available with 3/4", 1" or 1-1/2" NPT inlet / outlet
- Housing and Cap are molded from polypropylene which is compatible with a broad range of chemicals

BIG CLEAR

LARGE DIAMETER HOUSING FEATURES:

- Available 1" NPT inlet / outlet
- Housings are molded from Lexan (#10), Polycarbonate (#20)



Part No.	Sump	Head	Inlet / Outlet	Length	Width	Price
150469	#10 Blue	Black	3/4" NPT	13-1/8"	7-1/4"	
150467	#20 Blue	Black	3/4" NPT	23-3/8"	7-1/4"	
150238	#10 Blue	Black	1" NPT	13-1/8"	7-1/4"	
150234	#20 Blue	Black	1" NPT	23-3/8"	7-1/4"	
150240	#10 Blue	Black	1-1/2" NPT	13-5/8"	7-1/4"	
150236	#20 Blue	Black	1-1/2" NPT	23-3/8"	7-1/4"	
166219	#10 Clear	Blue	1" NPT	13-1/2"	7-1/8"	
166201	#20 Clear	Blue	1" NPT	23-3/4"	7-1/8"	

NOTE: The Big Clear Series of housings are not NSF component listed.

BIG BLUE® CARTRIDGE FEATURES: (4-1/2" DIA. X 10" LENGTH)

- Excellent for water well, institutional and light industrial applications
- 20 Square feet of media in every cartridge
- Pleated polyester fabric filter can be washed and reused several times. Reuse is not recommended in potable water applications
- Synthetic construction will not support bacteria growth
- Available with nominal 30 and 50 micron ratings

Part No.	Model	Medium	Construction	Micron	Mesh	GPM	Price
155101-51	R30-BB	Polyester	Pleated	30	420	25	
155053-51	R50-BB	Polyester	Pleated	50	300	25	
355221-43	WPX100BB97P	Filibraid	Wound	100	155	40	
SH144229	Cartridge Coupler used to connect 2 Cartridges for use in 20" filter						



INTRO
 1. ELECTRICAL
 2. PUMP Acc.
 3. HOSE, PE PIPE & Acc.
 4. IPS, PIP Pipe & Acc.
 5. SURFACE
 6. SPRINKLERS
 7. TRAVELER & WHEEL MOVE
 8. PIVOT
 9. TURF
 10. LOW VOLUME
 11. FILTERS
 12. INJECTION
 13. HARDWARE
 INDEX

LAKOS® TWISTIICLEAN FILTER

Key Features:

- Durable construction
- Just an easy TWIST of the handle to clean out the filter (purge)
- No Leaks or watery MESSSES
- Over 200% larger screen area than competing designs
- Cleans COMPLETELY after purge
- Innovative NEW technology
- Large selection of screen filters for every situation



TWISTIICLEAN

Model Number	Inlet/Outlet	Mesh	Micron	Length	Width	Price
T2C-075-100	3/4"	100	150	11-3/4"	8-3/4"	
T2C-100-100	1"	100	150	11-3/4"	8-3/4"	
T2C-150-100	1-1/2"	100	150	15-1/4"	11-3/4"	

Mesh Size Available	Micron	Element
30	600	Brown
60	250	White
100	150	Grey
140	105	Black

VU-FLOW FILTERS

Tee Style Screen Filter Features:

- 180° In-Line "T" style installation
- Increased effective screen area
- Case Quantity = 10 filters per case
- Filters can be ordered individually
- Mesh size is indicated by the part number

T-STYLE SCREEN FILTER - POLYESTER

Mesh Size	1" (1-25 GPM)	Price	1-1/2" (10-50 GPM)	Price	2" (18-100 GPM)	Price
30	NT100-30		NT150-30		NT200-30	
40	NT100-40		NT150-40		NT200-40	
60	NT100-60		NT150-60		NT200-60	
100	NT100-100		NT150-100		NT200-100	
140	NT100-140		NT150-140		NT200-140	
250	NT100-250		NT150-250		NT200-250	
500	NT100-500		NT150-500		NT200-500	

T-STYLE SCREEN FILTER - STAINLESS STEEL

Mesh Size	1" (1-25 GPM)	Price	1-1/2" (10-50 GPM)	Price	2" (18-100 GPM)	Price
30	NT100-30SSP		NT150-30SSP		NT200-30SSP	
60	NT100-60SSP		NT150-60SSP		NT200-60SSP	
100	NT100-100SSP		NT150-100SSP		NT200-100SSP	
140	NT100-140SSP		NT150-140SSP		NT200-140SSP	
200	NT100-200SSP		NT150-200SSP		NT200-200SSP	



VU-FLOW FILTERS

Combo Style Screen Filter Features:

- Versatile 90° "L" or 180° In-Line "T" style installation
- Increased effective screen area
- Case Quantity = 10 filters per case
- Filters can be ordered individually
- Mesh size is indicated by the part number

COMBO STYLE SCREEN FILTER - POLYESTER

Mesh Size	1-1/2" (10-50 GPM)	Price	2" (18-100 GPM)	Price
30	CF150-30P		CF200-30P	
40	CF150-40P		CF200-40P	
60	CF150-60P		CF200-60P	
100	CF150-100P		CF200-100P	
140	CF150-140P		CF200-140P	
250	CF150-250P		CF200-250P	
500	CF150-500P		CF200-500P	

COMBO STYLE SCREEN FILTER - STAINLESS STEEL

Mesh Size	1-1/2" (10-50 GPM)	Price	2" (18-100 GPM)	Price
30	CF150-30SSP		CF200-30SSP	
60	CF150-60SSP		CF200-60SSP	
100	CF150-100SSP		CF200-100SSP	
140	CF150-140SSP		CF200-140SSP	
200	CF150-200SSP		CF200-200SSP	



VU-FLOW 1" REPLACEMENT PARTS

Part No.	Description	Price
NT30B	1" Body	
NT30C	1" Cover	
NT30SCXXX	Screen	
NT30SCXXXSS	Screen	

VU-FLOW 1-1/2" REPLACEMENT PARTS

Part No.	Description	Price
NT60B	1.5" Body	
CF60B	1.5" Angle or Globe Body	
NT60C	Cover	
NT60SCXXX	Screen	
NT60SCXXXSS	Screen	

VU-FLOW 2" REPLACEMENT PARTS

Part No.	Description	Price
NT120B	2" Body	
CF120B	2" Angle or Globe Body	
NT120C	Cover	
NT120SCXXX	Screen	
NT120SCXXXSS	Screen	

XXX Specify Mesh Size: 24, 30, 40, 60, 100, 140, 200, 250, 500, 1000



INTRO
1. ELECTRICAL
2. PUMP ACC.
3. HOSE, PE PIPE & ACC.
4. IPS, PIP PIPE & ACC.
5. SURFACE
6. SPRINKLERS
7. TRAVELER & WHEEL MOVE
8. PIVOT
9. TURF
10. LOW VOLUME
11. FILTERS
12. INJECTION
13. HARDWARE
INDEX

YARDNEY FILTERS

YARDNEY MAXI-FLUSH® AUTOMATIC BACKWASH SCREEN FILTERS

Part No.	Rated Flow GPM 40-150 Mesh	Rated Flow GPM 200 Mesh	Inlet / Outlet Size	Maximum Pressure PSI	Shipping Weight Lbs.	System Price
AMFS6-2	250	167	4"	100	390	
AMFS8-2	500	334	6"	100	454	
AMFS8-3	750	500	6"	100	563	
AMFS10-2	1000	667	8"	100	585	
AMFS10-3	1500	1000	8"	100	1026	
AMFS10-4	2000	1334	10"	100	1470	
AMFS10-5	2500	1668	10"	100	1982	



Notes:

- Standard model includes stainless steel wedgewire cartridge.
Specify mesh size when ordering: 40, 60, 80, 100, 150, or 200.
- Mainline connections are grooved. Flanged available - consult factory.
- Grooved couplings & PVC groove x slip adapters not included.
- Backwash manifold & throttling valve not included.
- 12 Volt D/C latching solenoids for solar systems available.
Add \$___ list / each valve position at time of system purchase in lieu of standard solenoid.
- Solar package compatible with 12 volt D/C latching solenoids available for \$_____ list.
The package includes solar panel & battery pack, metering system, wiring harness & enclosure box.
Solar package part number 252550004.
- System is shipped unassembled.
- System is fusion epoxy lined with 3M Scotchkote™ 134 (or equal) as a standard.

YARDNEY MAXI-CLEAN® EPOXY COATED SCREEN FILTERS

Rated Flow GPM	Maximum Pressure PSI	Inlet / Outlet Size	Shipping Weight Grooved Lbs.	Shipping Weight Flanged Lbs.	Part No. Grooved	Grooved Price	Part No. Flanged	Flanged Price
110	100	2"	25	35	MCS2-1V		MCS2-1F	
225	100	3"	56	45	MCS3-1V		MCS3-1F	
400	100	4"	66	70	MCS4-1V		MCS4-1F	
900	100	6"	120	160	MCS6-1V		MCS6-1F	
1800	100	10"	400	440	MCS6-2V		MCS6-2F	
2700	100	12"	585	685	MCS6-3V		MCS6-3F	
3600	100	12"	815	885	MCS6-4V		MCS6-4F	
1250	100	8"	160	210	MCS8-1V		MCS8-1F	
2500	100	12"	435	585	MCS8-2V		MCS8-2F	



Notes:

- Standard models include polymeric mesh screen. Specify mesh size when ordering: 40, 80, 100, 150, or 200.
- System is fusion epoxy lined with 3M Scotchkote™ 134 (or equal) as a standard.

YARDNEY EPOXY LINED CARBON STEEL MINI MEDIA® SAND FILTERS

Part No.	Min. / Max. Rated Flow GPM	Maximum Pressure PSI	Inlet / Outlet Size	Shipping Weight Lbs.	Sand/Gravel Bags	Manual System Price	Automatic System Price
SP1016-2	15 / 30	125	1"	510	2/1		
SP1016-3	23 / 45	125	1"	765	3/1		

Notes:

- Units are fusion epoxy lined with 3M Scotchkote™ 134 (or equal) and include media and gravel pack, PVC manifolds and valves, automation package, liquid filled stainless steel pressure gauge, and backwash restrictor valve.



Note: Refer to page 11:28 for media.

YARDNEY FILTERS

YARDNEY CARBON STEEL SAND MEDIA FILTERS

Part No.	Min. / Max. Flow Rate GPM	Maximum Pressure PSI	Inlet / Outlet Size	Shipping Weight Lbs.	Rock/Sand Required Bags	Automatic System Price
1416-2	37 / 55	150	1.5"	130	2 / 4	
1816-2	60 / 88	150	2"	164	4 / 18	
1816-3	90 / 132	150	3"	239	6 / 12	
2416-2	107 / 158	150	3"	640	4 / 16	
2416-3	160 / 237	150	3"	510	6 / 24	
3016-2	170 / 250	125	4"	575	8 / 24	
3016-3	255 / 375	125	4"	863	12 / 36	
3616-2	238 / 350	105	4"	805	10 / 32	
3616-3	357 / 525	105	6"	1208	15 / 48	
4816-2	425 / 625	80	6"	1250	20 / 52	
4816-3	638 / 938	80	6"	1900	30 / 78	
4816-4	850 / 1250	80	8"	2580	40 / 104	
4816-5	1063 / 1563	80	10"	3220	50 / 130	
4816-6	1275 / 1875	80	10"	3880	60 / 156	
4816-7	1488 / 2188	80	10"	4480	70 / 182	
4816-8	1700 / 2500	80	10"	5160	80 / 208	
4816-9	1913 / 2813	80	12"	5800	90 / 234	
4816-10	2125 / 3125	80	12"	6440	100 / 260	



Notes:

1. Includes mainline inlet / outlet couplings & PVC adapters & liquid filled stainless steel pressure gauge.
2. Rock and sand not included in price. Please order and price separately.

YARDNEY TYPE 304 STAINLESS STEEL SAND MEDIA FILTERS

Part No.	Min. / Max. Flow Rate GPM	Maximum Pressure PSI	Inlet / Outlet Size	Shipping Weight Lbs.	Rock/Sand Required Bags	Automatic System Price
18Sww-2	60 / 88	100	2"	150	4 / 8	
18Sww-3	90 / 132	100	3"	215	6 / 12	
24Sww-2	107 / 158	100	3"	306	4 / 16	
24Sww-3	160 / 237	100	3"	459	6 / 24	
30Sww-2	170 / 250	100	4"	520	8 / 24	
30Sww-3	255 / 375	100	4"	776	12 / 36	
36Sww-2	238 / 350	80	4"	725	10 / 32	
36Sww-3	357 / 525	80	6"	1087	15 / 48	
48Sww-2	425 / 625	80	6"	1125	20 / 52	
48Sww-3	638 / 938	80	6"	1710	30 / 78	
48Sww-4	850 / 1250	80	8"	2322	40 / 108	
48Sww-5	1063 / 1563	80	10"	2898	50 / 130	
48Sww-6	1275 / 1875	80	10"	3492	60 / 156	
48Sww-7	1488 / 2188	80	10"	4032	70 / 182	
48Sww-8	1700 / 2500	80	10"	4644	80 / 208	
48Sww-9	1913 / 2813	80	12"	5220	90 / 234	
48Sww-10	2125 / 3125	80	12"	5796	100 / 260	



Notes:

1. Standard manifolds are stainless steel type 304. Optional carbon steel manifolds with fusion epoxy lined 3M Scotchkote™ 134 available at no additional cost. Please specify at time of order.
2. Includes mainline inlet / outlet couplings & PVC adapters & liquid filled stainless steel pressure gauge.
3. Not recommended for water sources containing chlorides above 750 PPM.
4. A sacrificial anode is provided with each stainless steel media filter vessel to help control crevice corrosion, micro-biological induced corrosion and electrolysis.
5. Rock and sand not included in price. Please order and price separately.

Note: Refer to page 11:28 for media.

- 1. INTRODUCTION
- 2. ELECTRICAL
- 3. PUMP, ACC.
- 4. HOSE, PE PIPE & ACC.
- 5. IPS, PIP PIPE & ACC.
- 6. SURFACE
- 7. SPRINKLERS
- 8. TRAVELER & WHEEL MOVE
- 9. PIVOT
- 10. TURF
- 11. LOW VOLUME
- 12. FILTERS
- 13. INJECTION
- 14. HARDWARE
- 15. INDEX

SAND SEPARATORS

SAND SEPARATORS

BARTOS CYCLONE SAND SEPARATOR & SEDIMENTATION TANK

Size	Part No.	Price	Part No.	Price
80 - 140 GPM	Cyclone 140		Sedtank 140	
230 - 360 GPM	Cyclone 360		Sedtank 360	

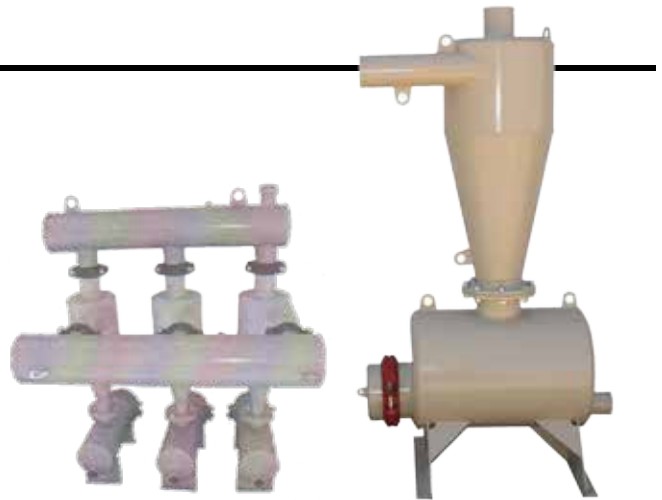

MANIFOLD INLET & OUTLET ASSEMBLY

Connection	Tube Size	Inlet	Outlet	Price
2	6	DS-IN2	DS-OUT2	
3	6	DS-IN3	DS-OUT3	
4	6	DS-IN4	DS-OUT4	
4	6	DS-IN4x8	DS-OUT4x8	
5	6	DS-IN5x8	DS-OUT5x8	

NETAFIM™ HYDROCYCLONE SAND SEPARATORS

Part No.	Model No.	Size	Flow Range GPM	Inlet / Outlet	Sedimentation Tank	Tank Connection	Price
72001-002000	74HC3	3"	11 - 17	3/4" TH	74ST004	1" TH	
72001-002200	74HC4	4"	15 - 26	1" TH	74ST004	1" TH	
72001-002500	74HC6	6"V	29 - 44	1-1/2" TH	74ST025	1-1/2" TH	
72001-002800	74HC8	8"V	48 - 84	2" GR	74ST025	2" TH	
72001-002900	74HC8HGR3	8" GR3	88 - 154	3" GR	74ST025GR3	3" GR	
72001-002950	74HC8HGR3H	8" GR3H	154 - 200	3" GR	74ST025GR3	3" GR	
72001-003500	74HC12FL4	12"	198 - 321	4" FL / 3" FL	74ST160FL4	4" FL	
72001-004500	74HC16FL4	16"	264 - 409	4" FL	74ST320FL4	4" FL	
72001-005200	74HC20FL6	20"	409 - 683	6" FL	74ST600FL6	6" FL	
72001-005400	74HC24FL6	24"	638 - 990	6" FL	74ST600FL6	6" FL	
72001-006000	74HC30FL6	30"	1,012 - 1,629	8" FL	74ST600FL6	8" FL	



NETAFIM™ SEDIMENTATION TANKS

Part No.	Model No.	Inlet	Drain	Tank Capacity	Used with Hydrocyclone	Price
72001-006800	74ST004	1/2" TH	1/2" TH	0.4 Gallons	74HC3, 74HC4	
72001-007000	74ST025	1" TH	1" TH	2.5 Gallons	74HC6, 74HC8	
72001-007200	74ST025GR3	3" GR	1" TH	2.5 Gallons	74HC8HGR3, 74HC8HGR3H	
72001-008000	74ST160FL4	4" FL	2" TH	16 Gallons	74HC12FL4	
72001-008500	74ST320FL4	4" FL	2" TH	32 Gallons	74HC16FL4	
72001-009400	74ST600FL6	6" FL	2" TH	60 Gallons	74HC20FL6, 74HC24FL6, 74HC30FL6,	

NETAFIM™ HYDROCYCLONE AUTOMATIC FLUSHING KITS

Part No.	Model No.	Description	Price
70021-000700	24HCAUTOKIT2-1DCL	2" Auto Flush Kit for 8" & 12" Hydrocyclones with DCL Controller	
70021-000721	24HCAUTOKIT3-1DCL	3" Auto Flush Kit for 16, 20" & 30" Hydrocyclones with DCL Controller	

FRESNO FLOW-GUARD 1600 SERIES SAND SEPARATOR

Part No.	Model No.	GPM	Inlet / Outlet	Pad Size (In) W x L	Price
P3950-01	3103	70-200	3"	18" x 30"	
P3950-02	3204	140-400	4"	36" x 36"	
P3950-03	3306	210-600	6"	36" x 54"	
P3950-04	3406	280-800	6"	36" x 72"	
P3950-05	4104	200-400	4"	18" x 30"	
P3950-06	4206	400-800	6"	36" x 36"	
P3950-07	4308	600-1200	8"	36" x 54"	
P3950-08	4408	800-1600	8"	36" x 72"	



YARDNEY SAND SEPARATORS

Sand separators are a viable solution for problems associated with sand, silt & gravel. It's durable 1/4" carbon steel construction makes it an excellent choice for tough & demanding duties. Since it has no moving parts, screens, filter media or backwash operation, the device is trouble-free, making it worry free. Sand separators will provide consistent, simple removal of 98% of 200 mesh (75 micron) or larger sand, gravel & other solids heavier than water. To achieve optimum product performance the separator must be properly sized & operated. Product selection & sizing is critically important as the model selection will determine how effective the centrifugal removal action is within the separator. Separators should only be used where the consistent operating flow rate is within the range of the separator model selected. If you have flow in excess or below the specified flow range of a particular model, effective centrifugal removal action is lost. In selection of the correct model separator, it is best to size the unit to the middle of the flow range if possible. This will allow for optimum particle removal without excessive pressure drop. Separators do not work well with solids that are light in mass, such as organic materials & are not recommended for applications requiring organic solids removal. Separated particles must be flushed on a regular basis to prevent the purge chamber from becoming compacted with contamination. An automatic purge is available & recommended when the separator is 1-1/2" & larger. Please let us know if you have any questions or if you need help in selecting the separator that is best for your application.

VERTICAL IN-LINE IRRIGATION SAND SEPARATORS

Part No.	GPM	Size	Length	Weight Lbs.	Price
R5V	4 - 10	1/2"	20"	13	
R7V	10 - 20	3/4"	20"	15	
R10V	18 - 38	1"	30-1/2"	26	
R12V	26 - 52	1-1/4"	30-1/2"	26	
R15V	38 - 79	1-1/2"	30-1/2"	26	
R20V	63 - 120	2"	36"	44	
R25V	100 - 180	2-1/2"	44"	55	
R30V	125 - 260	3"	48"	75	
R40V	190 - 345	4"	52"	120	



ANGLED IRRIGATION SAND SEPARATORS

Part No.	GPM	Size	Length	Weight Lbs.	Price
R40LA	200 - 400	4"	87"	280	
R60LA-LF	365 - 700	6"	115-1/2"	493	
R60LA-HF	500 - 950	6"	115-1/2"	493	
R80LA	800 - 1600	8"	124-3/4"	722	
R100LA	1300 - 2300	10"	135"	840	
R120LA	2025 - 3400	12"	156"	1400	
R140LA	2975 - 5000	14"	167"	1550	
R160LA	4000 - 6200	16"	182"	1850	

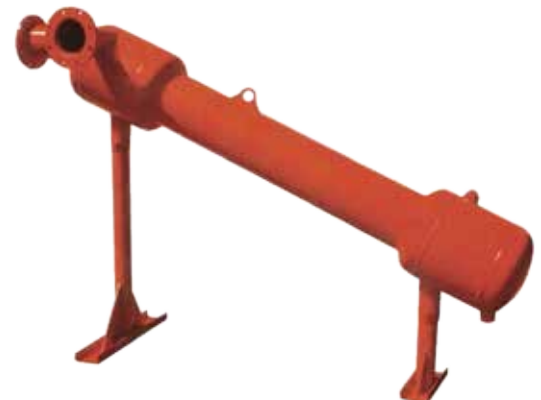

- INTRO
- 1. ELECTRICAL
- 2. PUMP ACC.
- 3. HOSE, PE PIPE & ACC.
- 4. IPS, PIP PIPE & ACC.
- 5. SURFACE
- 6. SPRINKLERS
- 7. TRAVELER & WHEEL MOVE
- 8. PIVOT
- 9. TURF
- 10. LOW VOLUME
- 11. FILTERS
- 12. INJECTION
- 13. HARDWARE
- INDEX

AUTOMATIC PURGE SYSTEMS

Periodic routine flushing of separated solids from the filter and separator collection chamber is very important to maintain a clean and well functioning system. While this can be done manually, it often makes more sense to automate the process so that you don't have to keep your eye on the clock or take time away from more productive work to manually perform this routine task. Therefore we're glad to offer you the following options.

MOTORIZED BALL VALVES

Featuring integrated programming circuitry, this valve can be set to purge as often as every 15 minutes, or as seldom as every 3.75 hours. Purge duration can be set anywhere from 12 to 90 seconds. This valve is more robust than the Daily Automatic Purge System and is recommended for heavier duty applications that are associated with irrigation. Settings are fixed with a simple arrangement of switches, located within the actuator housing. Some features of this product includes:

- Eliminates routine maintenance
- Minimizes water loss and concentrates solids for easy handling
- Straight-through ball valve; quick open-close actuator
- NEMA 4 watertight actuator housing, suitable for indoor / outdoor installations
- Solid-state circuitry

Part No.	Model No.	Description	Ship Weight Lbs.	Price
130594	AP-75-MBV	3/4" AccuPurge Automatic Valve For SandMaster, 110 or 220 VAC	10	
108070	CW-07-MBV	3/4" Compact Motorized Ball Valve - Bronze; 110 VAC	10	
108072	CW-15-MBV	1-1/2" Compact Motorized Ball Valve - Bronze; 110 VAC	16	
108075	CW-20-MBV	2" Compact Motorized Ball Valve - Bronze; 110 VAC	18	
106444	VP-07-HKV	3/4" Plastic Visual Purge Kit	1	
117074	MBCK-011	Mounting Bracket Clamp Kit (For: ILB-0037)	1	
111084	MBCK-022	Mounting Bracket Clamp Kit (For: ILB-0050, ILB-0075)	1	
106426	MBCK-033	Mounting Bracket Clamp Kit (For: ILB-0100, ILB-0125, ILB-0150)	2	
106428	MBCK-052	Mounting Bracket Clamp Kit (For: ILB-0200, ILB-0250)	5	
103021	*IKT-075-B	Manual Valve & Gauge Kit For 3/4" LAKOS Separator Purge	2	
103022	*IKT-150-B	Manual Valve & Gauge Kit For 1-1/2" LAKOS Separator Purge	4	
103023	*IKT-200-B	Manual Valve & Gauge Kit For 2" LAKOS Separator Purge	6	

*Note: Each IKT Kit contains (2) 160 PSI (11.2 bar) glycerin-filled pressure gauges (2-1/2 inch diameter gauge face) with appropriate petcock valves, elbows and a full-port manual isolation valve for the purge connection.



ELECTRIC ACTUATED BALL VALVES

1-1/2" & 2" Stainless steel full port valve, with remote control electric turn actuator and manual override. This actuator does not have a self-contained timing device, so it must operate from a separate controller device.

Part No.	Size	Description	Price
1.5T23SSRCEL005	1-1/2"	Compact Motorized Ball Valve	
2T23SSRCEL005	2"	Compact Motorized Ball Valve	

SAND & ROCK FOR SAND MEDIA FILTRATION

Our silica sand and crushed granite is selected to meet the filter manufacturers specifications for high quality and consistent uniformity in shape and size, which achieves superior filtration levels that meet or exceed up to 200 mesh filtration requirements for drip irrigation systems. More information including material specification sheets are available upon request.

SAND & ROCK FOR SAND MEDIA FILTRATION

Part No.	Description	Price
Y-ROCK	5/8" x 1/4" (No.3) Crushed Granite, 80 Lbs./Bag	
Y-SAND16/30	16/30 Quartz Silica Sand, 50 Lbs./Bag	
Y-SAND20/40	20/40 Quartz Silica Sand, 50 Lbs./Bag	



SELF CLEANING PUMP SUCTION SCREEN

The pump suction screen is attached to the end of the pump suction line by way of a standard flange. All water pulled in must go through the screen before entering the intake pipe. The 10, 18 or 30 mesh heavy stainless steel screen stops trash and debris from entering & creating problems associated with plugging. A small sidestream pump discharge return line drives two spray bars that continually rotate jet streams at the screen & blasts debris away from the screen. The unit is manufactured with heavy galvanized steel construction & a removable exterior basket for servicing.

Part No.	10/18 Mesh Max. Flow GPM	30 Mesh Max. Flow GPM	Flanged Inlet Size	Minimum Operating PSI	Return Flow Required GPM	Weight Lbs.	Price
CW200	325	225	4"	35	20	58	
CW400	550	400	6"	40	20	62	
CW600	750	525	8"	40	20	102	
CW800	950	700	10"	45	20	115	
CW1000	1350	950	10"	50	24	123	
CW1400	1550	1075	12"	55	24	131	
CW1700	1800	1250	12"	55	24	148	
CW2000	2100	1450	14"	60	24	160	
CW2400	2600	1800	16"	65	28	223	



CONE SCREENS

LATERAL LINE CONE SCREENS

Choose from our high quality stainless steel cone screens. For use in side rolls, pivots, travelers, lateral & hand move line or any system requiring removal of gravel, rust or other debris which may contaminate the system & plug nozzles. All screens are manufactured from perforated sheet with approx. 7/64" hole. Other types of filters & mesh options are available upon request.

Size	Length	Stainless Part No.	Price
2"	18"	2190-2X18	
3"	18"	2190-3X18	
3"	36"	2190-3X36	
4"	18"	2190-4X18	
4"	36"	2190-4X36	
5"	36"	2190-5X36	
6"	36"	2190-6X36	
7"	36"	2190-7X36	
8"	36"	2190-8X36	
10"	36"	2190-10X36	



**SILVER BULLIT IRRIGATION SCREEN
20 GAUGE 3/32 MESH**

Part No.	Description	Price
2518-KS	2.5" x 18" Lateral Line Screen	
318-KS	3" x 18" Lateral Line Screen	
336-KS	3" x 36" Lateral Line Screen	
418-KS	4" x 18" Lateral Line Screen	
436-KS	4" x 36" Lateral Line Screen	
536-KS	5" x 36" Lateral Line Screen	



INTAKE STRAINERS - OD TUBING CONNECTION

Standard 1/4" hole size - Aluminum construction

BASIC STRAINER WITH SLIDE (OD)

Part No.	OD Tubing Size	Weight Lbs.	Screen Open Area	Price
SFS2	2"	1.5	15 Sq. In.	
SFS3	3"	2.0	24 Sq. In.	
SFS4	4"	3.5	42 Sq. In.	
SFS5	5"	4.5	66 Sq. In.	
SFS6	6"	6.0	97 Sq. In.	
SFS8	8"	11.0	192 Sq. In.	
SFS10	10"	15.0	332 Sq. In.	



J STRAINER - SINGLE SCREEN WITH SLIDE (OD)

Part No.	OD Tubing Size	Weight Lbs.	Screen Open Area	Price
SFSJ4	4"	14.5	314 Sq. In.	
SFSJ5	5"	14.5	314 Sq. In.	
SFSJ6	6"	14.5	314 Sq. In.	
SFSJ8	8"	14.0	314 Sq. In.	
SFSJ10	10"	13.5	314 Sq. In.	
Price if Ordered Without Slide				



JD STRAINER - DOUBLE SCREEN WITH SLIDE (OD)

Part No.	OD Tubing Size	Weight Lbs.	Screen Open Area	Price
SFSJ4-D	4"	21.5	628 Sq. In.	
SFSJ5-D	5"	21.5	628 Sq. In.	
SFSJ6-D	6"	21.5	628 Sq. In.	
SFSJ8-D	8"	21.0	628 Sq. In.	
SFSJ10-D	10"	21.0	628 Sq. In.	
Price if Ordered Without Slide				



XL STRAINER WITH SLIDE (OD)

Part No.	OD Tubing Size	Weight Lbs.	Screen Open Area	Price
SFS6XL	6"	52.0	972 Sq. In.	
SFS8XL	8"	51.5	972 Sq. In.	
SFS10XL	10"	51.0	972 Sq. In.	
SFS12XL	12"	53.5	972 Sq. In.	
Price if Ordered Without Slide (Excludes SFS12XL)				



HORIZONTAL STRAINER WITHOUT SLIDE (OD)

Part No.	OD Tubing Size	Weight Lbs.	Screen Open Area	Price
SFSH4	4"	20.5	470 Sq. In.	
SFSH6	6"	22.0	470 Sq. In.	
SFSH8	8"	23.5	470 Sq. In.	

Available with slide, please call for pricing.



INTAKE STRAINERS - IPS PIPE CONNECTION

Standard 1/4" hole size - Aluminum construction

BASIC STRAINER (IPS)

Part No.	OD Tubing Size	Weight Lbs.	Screen Open Area	Price
SPVC4	4"	4.0	61 Sq. In.	
SPVC6	6"	5.5	97 Sq. In.	
SPVC8	8"	8.0	190 Sq. In.	
SPVC10	10"	12.0	314 Sq. In.	



J STRAINER - SINGLE SCREEN (IPS)

Part No.	OD Tubing Size	Weight Lbs.	Screen Open Area	Price
SPVCJ6	6"	19.5	314 Sq. In.	
SPVCJ8	8"	19.0	314 Sq. In.	



JD STRAINER - DOUBLE SCREEN (IPS)

Part No.	OD Tubing Size	Weight Lbs.	Screen Open Area	Price
SPVCJ6-D	6"	27.0	628 Sq. In.	
SPVCJ8-D	8"	27.0	628 Sq. In.	



XL STRAINER (IPS)

Part No.	OD Tubing Size	Weight Lbs.	Screen Open Area	Price
SPVC12	12"	53.5	972 Sq. In.	
SPVC15	15"	46.0	972 Sq. In.	
SPVC16	16"	45.5	972 Sq. In.	

Opening Size: SPVC12: 12.875" SPVC15: 15.375" SPVC16: 16.25"

INTRO
1. ELECTRICAL
2. PUMP ACC.
3. HOSE, PE PIPE & ACC.
4. IPS, PIP PIPE & ACC.
5. SURFACE
6. SPRINKLERS
7. TRAVELER & WHEEL MOVE
8. PIVOT
9. TURF
10. LOW VOLUME
11. FILTERS
12. INJECTION
13. HARDWARE
INDEX

INTAKE STRAINERS - THREADED CONNECTION

ROUND HOLE STRAINER (THREADED)

Part No.	FIPT Size	Weight Lbs.	Screen Open Area	Price
RHS150	1-1/2"	1.5	19 Sq. In.	
RHS200	2"	1.9	26 Sq. In.	
RHS250	2-1/2"	2	26 Sq. In.	
RHS300	3"	3	40 Sq. In.	
RHS400	4"	3	42 Sq. In.	
RHS600	6"	11	144 Sq. In.	
RHS800	8"	22	219 Sq. In.	

Note: 1-1/2" - 4" is 3/8" hole size / 6" - 12" is 1" hole size / Zinc plated steel construction



BASIC STRAINER (THREADED)*

Part No.	FIPT Size	Weight Lbs.	Screen Open Area	Price
SFS2P	2"	2.0	15 Sq. In.	
SFS25P	2-1/2"	2.0	23 Sq. In.	
SFS3P	3"	2.5	38 Sq. In.	
SFS4P	4"	6.5	97 Sq. In.	
SFS4P With Slide				



J STRAINER - SINGLE SCREEN WITHOUT SLIDE (THREADED)*

Part No.	FIPT Size	Weight Lbs.	Screen Open Area	Price
SFSJ4FP	4"	17.0	314 Sq. In.	
SFSJ5FP	5"	17.5	314 Sq. In.	
SFSJ6FP	6"	17.5	314 Sq. In.	
SFSJ8FP	8"	18.0	314 Sq. In.	
SFSJ10FP	10"	21.5	314 Sq. In.	
With Slide Add				



JD STRAINER - DOUBLE SCREEN WITHOUT SLIDE (THREADED)*

Part No.	FIPT Size	Weight Lbs.	Screen Open Area	Price
SFSJ4FP-D	4"	24.5	628 Sq. In.	
SFSJ5FP-D	5"	25.0	628 Sq. In.	
SFSJ6FP-D	6"	25.0	628 Sq. In.	
SFSJ8FP-D	8"	25.5	628 Sq. In.	
SFSJ10FP-D	10"	29.0	628 Sq. In.	
With Slide Add				

* Standard 1/4" hole size - Aluminum construction

INTAKE STRAINERS - COMPANION FLANGE CONNECTION

Matches the bolt pattern of a standard 125 lb cast iron companion flange or a Schedule 80 PVC flange.
Standard 1/4" hole size - Aluminum construction.

BASIC STRAINER WITH SLIDE (C.F.C)

Part No.	Flange Size	Weight Lbs.	Screen Open Area	Price
SFSF2	2"	3.5	44 Sq. In.	
SFSF3	3"	5.5	54 Sq. In.	
SFSF4	4"	6.5	81 Sq. In.	
SFSF6	6"	9.0	160 Sq. In.	
SFSF8	8"	16.0	250 Sq. In.	



J STRAINER - SINGLE SCREEN (C.F.C)

Part No.	Flange Size	Weight Lbs.	Screen Open Area	Price
SFSFJ4	4"	16.5	314 Sq. In.	
SFSFJ6	6"	15.5	314 Sq. In.	



JD STRAINER - DOUBLE SCREEN (C.F.C)

Part No.	Flange Size	Weight Lbs.	Screen Open Area	Price
SFSFJ4-D	4"	24.0	628 Sq. In.	
SFSFJ6-D	6"	22.5	628 Sq. In.	



XL STRAINER (C.F.C)

Part No.	Flange Size	Weight Lbs.	Screen Open Area	Price
SFSF10	10"	50.5	972 Sq. In.	
SFSF12	12"	54.5	972 Sq. In.	

INTRO
1. ELECTRICAL
2. PUMP ACC.
3. HOSE, PE PIPE & ACC.
4. IPS, PIP PIPE & ACC.
5. SURFACE
6. SPRINKLERS
7. TRAVELER & WHEEL MOVE
8. PIVOT
9. TURF
10. LOW VOLUME
11. FILTERS
12. INJECTION
13. HARDWARE
INDEX

SECTION 12

Injection Equipment

CONTENTS

- 12:3 INJECTION EQUIPMENT NOTES
- 12:4-11 FERTILIZER & CHEMIGATION SYSTEMS
 - 12:4 AGRI-INJECT MISTER MIST'R® INJECTION CHECK VALVE & ACCESSORIES
 - 12:5 AGRI-INJECT FERTILIZER INJECTION SYSTEM
 - 12:6 AGRI-INJECT FERTILIZER INJECTION SYSTEM, ACID READY
 - 12:6 AGRI-INJECT PROPORTIONAL INJECTION SYSTEM
 - 12:7 AGRI-INJECT INSECTIGATOR III CHEMIGATION SYSTEMS
 - 12:7 AGRI-INJECT CHEMIGATION SYSTEMS
 - 12:8 INJECT-O-METER CHEMIGATION CHECK VALVE
 - 12:8 INJECT-O-METER INJECTION SYSTEMS
 - 12:9 INJECT-O-METER INJECTION SYSTEMS
 - 12:10 INJECT-O-METER CHEMIGATION SYSTEMS
 - 12:11 INJECT-O-METER CHEMIGATION SYSTEMS
- 12:12 FERTIGATION SYSTEM
 - 12:12 EZ-FLO FERTIGATION SYSTEM
- 12:13 COMPOST TEA SYSTEMS
 - 12:13 EZ-FLO FERTIGATION SYSTEM
 - 12:13 ERATH EARTH FERTIGATION SYSTEM
 - 12:13 ERATH EARTH COMPOST TEA EXTRACTOR & BREWING SYSTEMS
- 12:14-15 INJECTION EQUIPMENT
- 12:16-17 TESTERS, CHECKERS, METERS, & SOLUTIONS
- 12:18 CAM LEVER FITTINGS
- 12:19-20 POLYPROPYLENE PIPE THREAD FITTINGS
- 12:21 POLYPROPYLENE HOSE BARB FITTINGS

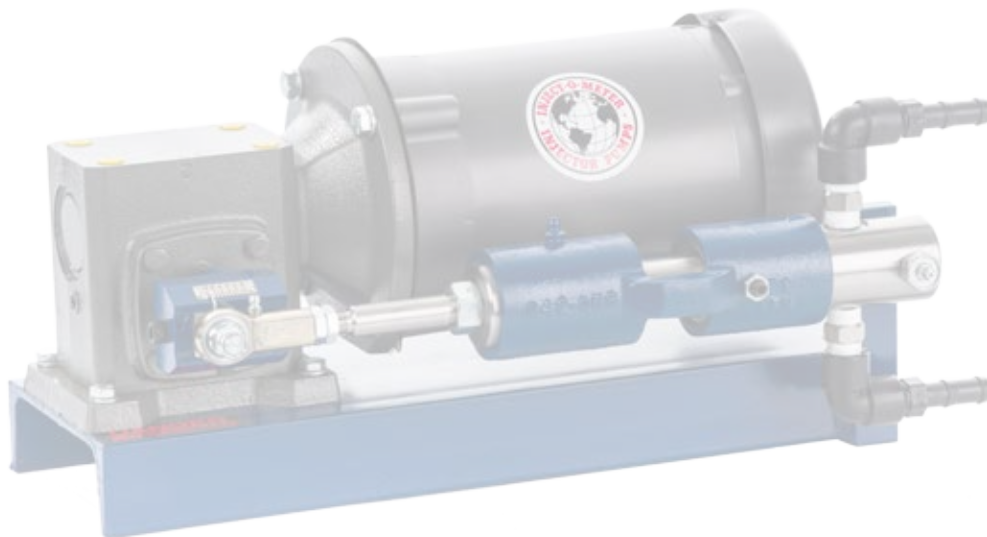

AGRI-INJECT MISTER MIST'R® INJECTION CHECK VALVE & ACCESSORIES

MINI MISTER MIST'R® - POLY (UP TO 3 GPH)

Part No.	Size	Description	Price
820-02-060000-0	3/4" x 3/8" x 5"	Mini Mist'r Assembly	
820-02-000100-0		Mini Mist'r Assembly & Bleeder	

CLASSIC "SHORTY" MISTER MIST'R® - POLY - 15 PSI (0.5 TO 70 GPH)

Part No.	Size	Description	Price
820-02-008128-0	3/4" x 1/4" x 4"	"Shorty" Mister Mist'r®	
820-02-000200-0		"Shorty" Mister Mist'r® & Bleeder	
820-02-008128-1		"Shorty" Mister Mist'r®, Acid	
820-02-000200-1		"Shorty" Mister Mist'r® & Bleeder, Acid	

CLASSIC MISTER MIST'R® - POLY - 15 PSI (0.5 TO 70 GPH)

Part No.	Size	Description	Price
820-02-008000-0	3/4" x 1/4" x 6"	Mister Mist'r®	
820-02-000000-0		Mister Mist'r® & Bleeder	
820-02-008000-1		Mister Mist'r®, Acid	
820-02-000000-1		Mister Mist'r® & Bleeder, Acid	

ULTRA MISTER MIST'R® - POLY - 15 PSI (3 TO 110 GPH)

Part No.	Size	Description	Price
820-02-008100-0	3/4" x 1/2" x 6"	Ultra Mister Mist'r®	
820-02-181012-0		Ultra Mister Mist'r® & Bleeder, 3/8" JG Ultra Bleeder	
820-02-008100-1		Ultra Mister Mist'r®, PVDF, Acid	
820-02-181002-A		Ultra Mister Mist'r® & Bleeder, 1/2" MNPT Ultra Bleeder, PVDF, Acid	

MISTER MIST'R® - STAINLESS STEEL - 15 PSI (15 TO 300 GPH)

Part No.	Size	Description	Price
820-50-016128-0	3/4" x 1/2" x 4"	Mister Mist'r®	
820-50-000000-1		Mister Mist'r® & Bleeder	
820-50-016256-0	3/4" x 1/2" x 8"	Mister Mist'r®	
820-50-000000-0		Mister Mist'r® & Bleeder	

MISTER MIST'R® - CPVC - 15 PSI (15 TO 150 GPH)

Part No.	Size	Description	Price
820-01-014256-0	3/4" x 1/2" x 3"	Mister Mist'r®, Acid	
820-01-016256-0	3/4" x 1/2" x 6"	Mister Mist'r®, Acid	
820-05-000000-0		Mister Mist'r® & Bleeder, Acid	

BLEEDER VALVES & FITTINGS

Part No.	Size	Description	Price
821-02-008008-0	1/4"	Bleeder Valve Assembly, PP	
821-02-008000-0	1/4"	Bleeder Valve & Fitting Assembly	
821-02-008000-A	1/4"	Bleeder Valve & Fitting Assembly, Acid	
199-01-012008-1	3/8" x 1/4"	JG Male Connector	
199-09-012012-1	3/8" x 3/8"	JG Plug-In Elbow	
198-19-012008-0	3/8" x 1/4"	TS Male Connector, Acid	
198-19-012012-0	3/8" x 3/8"	TS Plug-In Elbow, Acid	
260-02-187125-0	.187" x .125"	Microtube PE, 1 Ft.	
821-02-008008-1	1/4"	Bleeder Valve Assembly & Plug	
821-01-016000-0	1/2"	Bleeder Valve & Fitting Assembly	
821-01-016024-0	1/2" x 3/4"	Bleeder & Fitting Assembly	
821-02-016012-0	1/2" x 3/8"	Ultra Bleeder Valve Quick Connect	
821-02-016001-0	1/2" x 1/2"	Ultra Bleeder Valve FPT x 1/2" Barb	
821-02-016000-A	1/2" x 1/2"	Ultra Bleeder Valve Acid FPT x 1/2" Barb	



MISTER MIST'R® HOSE ASSEMBLIES & FITTINGS

Part No.	Size	Description	Price
849-10-008012-0	1/4" x 3/8" x 12'	Hose Kit, High Pressure, Black	
849-10-008012-1	1/4" x 3/8" x 20'	Hose Kit, High Pressure, Black	
849-10-016012-0	1/2" x 3/8" x 12'	Hose Kit, High Pressure, Black	
849-07-016012-0	1/2" x 3/8" x 12'	Hose Kit, Grey Braid	
199-13-012008-0	3/8" x 1/4"	JG Male Connector to Hose	
199-13-012012-1	3/8" x 3/8"	JG Male Connector to Hose	
199-13-012016-1	3/8" x 1/2"	JG Male Connector to Hose	
198-19-012008-5	3/8" x 1/4"	TS Male Connector to Hose	
198-19-012012-5	3/8" x 3/8"	TS Male Connector to Hose	



AGRI-INJECT FERTILIZER INJECTION SYSTEM

18 GPH MROY P SIMPLEX FERTILIZER SYSTEM

Part No.	Description	Price
881-01-111018-0	Complete System w/Switch, Strainer, Mister Mist'r, 1PH	
881-02-111018-0	Complete System w/Switch, Strainer, Mister Mist'r, 12V	
881-03-111018-0	Complete System w/Switch, Strainer, Mister Mist'r, 3PH	

25 GPH MROY D SIMPLEX FERTILIZER SYSTEM

Part No.	Description	Price
881-01-111025-D	Complete System w/Switch, Strainer, Mister Mist'r, 1PH	
881-02-111025-D	Complete System w/Switch, Strainer, Mister Mist'r, 12V	
881-03-111025-D	Complete System w/Switch, Strainer, Mister Mist'r, 3PH	

30 GPH MROY A SIMPLEX FERTILIZER SYSTEM

Part No.	Description	Price
881-01-111030-0	Complete System w/Switch, Strainer, Mister Mist'r, 1PH	
881-02-111030-0	Complete System w/Switch, Strainer, Mister Mist'r, 12V	
881-03-111030-0	Complete System w/Switch, Strainer, Mister Mist'r, 3PH	

50 GPH MROY D SIMPLEX FERTILIZER SYSTEM

Part No.	Description	Price
881-01-111050-D	Complete System w/Switch, Strainer, Mister Mist'r, 1PH	
881-02-111050-D	Complete System w/Switch, Strainer, Mister Mist'r, 12V	
881-03-111050-D	Complete System w/Switch, Strainer, Mister Mist'r, 3PH	

55 GPH MROY G SIMPLEX FERTILIZER SYSTEM

Part No.	Description	Price
881-01-111055-0	Complete System w/Switch, Strainer, Mister Mist'r, 1PH	
881-02-111055-0	Complete System w/Switch, Strainer, Mister Mist'r, 12V	
881-03-111055-0	Complete System w/Switch, Strainer, Mister Mist'r, 3PH	

110 GPH MROY G SIMPLEX FERTILIZER SYSTEM

Part No.	Description	Price
881-01-111110-0	Complete System w/Switch, Strainer, Mister Mist'r, 1PH	
881-02-111110-0	Complete System w/Switch, Strainer, Mister Mist'r, 12V	
881-03-111110-0	Complete System w/Switch, Strainer, Mister Mist'r, 3PH	

150 GPH MROY G SIMPLEX FERTILIZER SYSTEM

Part No.	Description	Price
881-01-111150-0	Complete System w/Switch, Strainer, Mister Mist'r, 1PH	
881-02-111150-0	Complete System w/Switch, Strainer, Mister Mist'r, 12V	
881-03-111150-0	Complete System w/Switch, Strainer, Mister Mist'r, 3PH	



WE CARRY THE COMPLETE LINE OF AGRI-INJECT WHOLE GOODS AND PARTS. IF YOU DO NOT FIND WHAT YOU ARE LOOKING FOR IN THIS SECTION, PLEASE CALL US TO DISCUSS YOUR INDIVIDUAL NEEDS.

AGRI-INJECT FERTILIZER INJECTION SYSTEM, ACID READY

8 GPH MROY D SIMPLEX FERTILIZER SYSTEM (ACID READY)

Part No.	Description	Price
881-01-200008-A	Pump Base and Cord, 1PH	
881-01-111008-A	Complete System w/Switch, Strainer, Mister Mist'r, 1PH	
881-02-111008-A	Complete System w/Switch, Strainer, Mister Mist'r, 12V	
881-03-111008-A	Complete System w/Switch, Strainer, Mister Mist'r, 3PH	

18 GPH MROY P SIMPLEX FERTILIZER SYSTEM (ACID READY)

Part No.	Description	Price
881-01-111018-A	Complete System w/Switch, Strainer, Mister Mist'r, 1PH	
881-02-111018-A	Complete System w/Switch, Strainer, Mister Mist'r, 12V	
881-03-111018-A	Complete System w/Switch, Strainer, Mister Mist'r, 3PH	

25 GPH MROY D SIMPLEX FERTILIZER SYSTEM (ACID READY)

Part No.	Description	Price
881-01-111025-A	Complete System w/Switch, Strainer, Mister Mist'r, 1PH	
881-02-111025-A	Complete System w/Switch, Strainer, Mister Mist'r, 12V	
881-03-111025-A	Complete System w/Switch, Strainer, Mister Mist'r, 3PH	

30 GPH MROY A SIMPLEX FERTILIZER SYSTEM (ACID READY)

Part No.	Description	Price
881-01-111030-A	Complete System w/Switch, Strainer, Mister Mist'r, 1PH	
881-02-111030-A	Complete System w/Switch, Strainer, Mister Mist'r, 12V	
881-03-111030-A	Complete System w/Switch, Strainer, Mister Mist'r, 3PH	

50 GPH MROY D SIMPLEX FERTILIZER SYSTEM (ACID READY)

Part No.	Description	Price
881-01-111050-A	Complete System w/Switch, Strainer, Mister Mist'r, 1PH	
881-02-111050-A	Complete System w/Switch, Strainer, Mister Mist'r, 12V	
881-03-111050-A	Complete System w/Switch, Strainer, Mister Mist'r, 3PH	

55 GPH MROY G SIMPLEX FERTILIZER SYSTEM (ACID READY)

Part No.	Description	Price
881-01-111055-A	Complete System w/Switch, Strainer, Mister Mist'r, 1PH	
881-02-111055-A	Complete System w/Switch, Strainer, Mister Mist'r, 12V	
881-03-111055-A	Complete System w/Switch, Strainer, Mister Mist'r, 3PH	



AGRI-INJECT PROPORTIONAL INJECTION SYSTEM

PROPORTIONAL INJECTION SYSTEM - PRECISION CONTROLLED INJECTION

Part No.	Description	Price
885-00-100030-1	Complete System, Strainer, Cal tube, Flow Sensor Mister Mist'r, 1PH	
885-00-300030-1	Complete System, Strainer, Cal tube, Flow Sensor Mister Mist'r, 3PH	

Sizes/Capacities: 30 simplex and 30/30 duplex; other sizes available

Uses and Applications:

- Swing Arm Pivots
- Variable water flow and consistent water flow applications
- Golf courses
- City Parks
- Sports Complexes
- Water amendment = pH EC adjustment

Pump Specifications:

- Milton Roy Series positive displacement diaphragm metering pump
- Simplex single head or Duplex dual head configurations
- Manual micrometer control
- Calibration Column
- 5 year pump warranty

Control Panel Specifications:

- Custom single or 3 phase drive
- Size:7.5"H x 6.12"W x 4.22"D
- Nema type 4 rugged steel enclosure
- Easy to understand keypad
- Easy to read 16 character LCD display



AGRI-INJECT INSECTIGATOR III CHEMIGATION SYSTEMS

10 GALLON TANK SYSTEM

Part No.	Description	Price
888-01-112019-0	Insectigator, 1PH, Mixer, 1.9 GPH Fig Pump	
888-01-212019-0	Insectigator, 12V, Mixer, 1.9 GPH Fig Pump	
888-01-312019-0	Insectigator, 3PH, Mixer, 1.9 GPH Fig Pump	

20 GALLON TANK SYSTEM

Part No.	Description	Price
888-02-112019-0	Insectigator, 1PH, Mixer, 1.9 GPH Fig Pump	
888-02-212019-0	Insectigator, 12V, Mixer, 1.9 GPH Fig Pump	
888-02-312019-0	Insectigator, 3PH, Mixer, 1.9 GPH Fig Pump	

30 GALLON TANK SYSTEM

Part No.	Description	Price
888-03-112019-0	Insectigator, 1PH, Mixer, 1.9 GPH Fig Pump	
888-03-212019-0	Insectigator, 12V, Mixer, 1.9 GPH Fig Pump	
888-03-312019-0	Insectigator, 3PH, Mixer, 1.9 GPH Fig Pump	



AGRI-INJECT CHEMIGATION SYSTEMS

70 GALLON TANK SYSTEM

Part No.	Description	Price
888-07-112SIM-0	Complete System w/Simplex Mroy A/P Pump, 2 Switches, Mixer, 1PH	
888-07-112DUP-0	Complete System w/Duplex Mroy A/P Pump, 2 Switches, Mixer, 1PH	
888-07-212SIM-0	Complete System w/Simplex Mroy A/P Pump, 2 Switches, Mixer, 12V	
888-07-212DUP-0	Complete System w/Duplex Mroy A/P Pump, 2 Switches, Mixer, 12V	
888-07-312SIM-0	Complete System w/Simplex Mroy A/P Pump, 2 Switches, Mixer, 3PH	
888-07-312DUP-0	Complete System w/Duplex Mroy A/P Pump, 2 Switches, Mixer, 3PH	

110 GALLON TANK SYSTEM

Part No.	Description	Price
888-11-112SIM-0	Complete System w/Simplex Mroy A/P Pump, 2 Switches, Mixer, 1PH	
888-11-112DUP-0	Complete System w/Duplex Mroy A/P Pump, 2 Switches, Mixer, 1PH	
888-11-212SIM-0	Complete System w/Simplex Mroy A/P Pump, 2 Switches, Mixer, 12V	
888-11-212DUP-0	Complete System w/Duplex Mroy A/P Pump, 2 Switches, Mixer, 12V	
888-11-312SIM-0	Complete System w/Simplex Mroy A/P Pump, 2 Switches, Mixer, 3PH	
888-11-312DUP-0	Complete System w/Duplex Mroy A/P Pump, 2 Switches, Mixer, 3PH	

200 GALLON TANK SYSTEM

Part No.	Description	Price
888-20-112SIM-0	Complete System w/Simplex Mroy A/P Pump, 2 Switches, Mixer, 1PH	
888-20-112DUP-0	Complete System w/Duplex Mroy A/P Pump, 2 Switches, Mixer, 1PH	
888-20-212SIM-0	Complete System w/Simplex Mroy A/P Pump, 2 Switches, Mixer, 12V	
888-20-212DUP-0	Complete System w/Duplex Mroy A/P Pump, 2 Switches, Mixer, 12V	
888-20-312SIM-0	Complete System w/Simplex Mroy A/P Pump, 2 Switches, Mixer, 3PH	
888-20-312DUP-0	Complete System w/Duplex Mroy A/P Pump, 2 Switches, Mixer, 3PH	

Note: Simplex Pumps are usually ordered for chemigation only, while duplex pumps are commonly used for both chemigation and fertigation. Simplex Pumps are available in maximum flow rates of 2.5, 5.6, 11.1, 18 and 30 GPH. Duplex Pumps include the following combinations of 2.5 x 18, 5.6 x 18, 18 x 18, 4 x 30, 6 x 30, and 30 x 30 GPH. Larger pumps and tank systems are available upon request. Please let us know if we can assist you in making the right selection for your needs.



NITRO
 1. ELECTRICAL
 2. PUMP, ACC.
 3. HOSE, PE PIPE & ACC.
 4. IPS, PIP PIPE & ACC.
 5. SURFACE
 6. SPRINKLERS
 7. TRAVELER & WHEEL, MOVE
 8. PIVOT
 9. TURF
 10. LOW VOLUME
 11. FILTERS
 12. INJECTION
 13. HARDWARE
 INDEX

INJECT-O-METER CHEMIGATION CHECK VALVE

316 Stainless Steel Construction and Viton Seat for Strength and Chemical Resistance
 *Self Cleaning *3 Directional Spray *Meets Federal Requirements



MAX-94 CHEMIGATION CHECK VALVE AND ACCESSORIES

Part No.	Description	Price
049-085	Max-94 Stainless Steel Chemigation Check Valve	
011-033	Bleeder Valve for Removing Air from the Line	

INJECT-O-METER INJECTION SYSTEMS

INJECT-O-METER - SIMPLEX - SINGLE PHASE

Part No.	Description	Min. GPH Output	Max. GPH Output	Price
IOM-3302	IOM-330 1/3HP 1PH Injector No Hose Kit	3.0	30.0	
IOM-3306	IOM-330 1/3HP 1PH Injector w/Hose Kit	3.0	30.0	
N/P	I70 (.25) 1/3HP 1PH Injector w/Hose Kit	.20	2.0	
001-117	I70 (.375) 1/3HP 1PH Injector w/Hose Kit	.45	4.5	
001-129	I70 (.50) 1/3HP 1PH Injector w/Hose Kit	.80	8.0	
001-134	I70 (.625) 1/3HP 1PH Injector w/Hose Kit	1.25	12.5	
001-011	I70 (.75) 1/3HP 1PH Injector w/Hose Kit	1.80	18.0	
014-009	HVI-88 1/3HP 1PH Injector w/Hose Kit	3.0	30.0	
007-003	HVI-82 1/3HP 1PH Injector w/Hose Kit	5.7	57.0	
015-013	IOM-96 1/3HP 1PH Injector w/Hose Kit	10.0	100.0	



INJECT-O-METER - SIMPLEX - 3 PHASE

Part No.	Description	Min. GPH Output	Max. GPH Output	Price
IOM-3301	IOM-330 1/3HP 3PH Injector No Hose Kit	3.0	30.0	
IOM-3305	IOM-330 1/3HP 3PH Injector w/Hose Kit	3.0	30.0	
001-073	I70 (.25) 1/3HP 3PH Injector w/Hose Kit	.20	2.0	
001-119	I70 (.375) 1/3HP 3PH Injector w/Hose Kit	.45	4.5	
001-122	I70 (.50) 1/3HP 3PH Injector w/Hose Kit	.80	8.0	
001-114	I70 (.625) 1/3HP 3PH Injector w/Hose Kit	1.25	12.5	
001-110	I70 (.75) 1/3HP 3PH Injector w/Hose Kit	1.80	18.0	
014-024	HVI-88 1/3HP 3PH Injector w/Hose Kit	3.0	30.0	
007-044	HVI-82 1/3HP 3PH Injector w/Hose Kit	5.7	57.0	
015-017	IOM-96 1/3HP 3PH Injector w/Hose Kit	10.0	100.0	



INJECT-O-METER - SIMPLEX - 12V DC

Part No.	Description	Min. GPH Output	Max. GPH Output	Price
001-131	I70 (.25) 1/2HP 12VDC Injector w/o Hose Kit	.20	2.0	
001-226	I70 (.375) 1/2HP 12VDC Injector w/Hose Kit	.45	4.5	
001-132	I70 (.50) 1/2HP 12VDC Injector w/Hose Kit	.80	8.0	
N/P	I70 (.625) 1/2HP 12VDC Injector w/Hose Kit	1.25	12.5	
001-034	I70 (.75) 1/2HP 12VDC Injector w/Hose Kit	1.80	18.0	
014-027	HVI-88 1/2HP 12VDC Injector w/Hose Kit	3.0	30.0	
007-012	HVI-82 3/4HP 12VDC Injector w/Hose Kit	5.7	57.0	
015-059	IOM-96 1/2HP 12VDC Injector w/Hose Kit	10.0	100.0	



INJECT-O-METER - BELT DRIVEN PUMPS - SIMPLEX @ 1725 RPM

Part No.	Description	Min. GPH Output	Max. GPH Output	Price
001-077	I70 (.25) w/Hose Kit & Mounting Bracket	.20	2.0	
001-065	I70 (.375) w/Hose Kit & Mounting Bracket	.45	4.5	
001-053	I70 (.50) w/Hose Kit & Mounting Bracket	.80	8.0	
001-041	I70 (.625) w/Hose Kit & Mounting Bracket	1.25	12.5	
001-004	I70 (.75) w/Hose Kit & Mounting Bracket	1.80	18.0	
014-001	HVI-88 w/Hose Kit & Mounting Bracket	3.0	30.0	
007-011	HVI-82 w/Hose Kit & Mounting Bracket	5.7	57.0	
015-005	IOM-96 w/Hose Kit & Mounting Bracket	7.6	76.0	



INJECT-O-METER INJECTION SYSTEMS

INJECT-O-METER - DUPLEX - SINGLE PHASE

Part No.	Description	Min. GPH Output	Max. GPH Output	Price
001-135	I70 (.25) 1/3HP 1 PH Injector w/Hose Kit	.40	4.0	
N/P	I70 (.375) 1/3HP 1 PH Injector w/Hose Kit	.90	9.0	
001-133	I70 (.50) 1/3HP 1 PH Injector w/Hose Kit	1.6	16.0	
N/P	I70 (.625) 1/3HP 1 PH Injector w/Hose Kit	2.5	25.0	
001-017	I70 (.75) 1/3HP 1 PH Injector w/Hose Kit	3.6	36.0	
014-013	HVI-88 1/3HP 1 PH Injector w/Hose Kit	6.0	60.0	
007-047	HVI-82 1/3HP 1 PH Injector w/Hose Kit	11.4	114.0	
015-037	IOM-96 1/2HP 1 PH Injector w/Hose Kit	20.0	200.00	



INJECT-O-METER - DUPLEX - 3 PHASE

Part No.	Description	Min. GPH Output	Max. GPH Output	Price
001-075	I70 (.25) 1/3HP 3PH Injector w/Hose Kit	.40	4.0	
001-063	I70 (.375) 1/3HP 3PH Injector w/Hose Kit	.90	9.0	
001-051	I70 (.50) 1/3HP 3PH Injector w/Hose Kit	1.6	16.0	
001-039	I70 (.625) 1/3HP 3PH Injector w/Hose Kit	2.5	25.0	
001-104	I70 (.75) 1/3HP 3PH Injector w/Hose Kit	3.6	36.0	
014-025	HVI-88 1/3HP 3PH Injector w/Hose Kit	6.0	60.0	
007-045	HVI-82 1/3HP 3PH Injector w/Hose Kit	11.4	114.0	
015-042	IOM-96 1/2HP 3PH Injector w/Hose Kit	20.0	200.00	



INJECT-O-METER - DUPLEX - 12V DC

Part No.	Description	Min. GPH Output	Max. GPH Output	Price
N/P	I70 (.25) 1/2HP 12VDC Injector w/Hose Kit	.40	4.0	
N/P	I70 (.375) 1/2HP 12VDC Injector w/Hose Kit	.90	9.0	
N/P	I70 (.50) 1/2HP 12VDC Injector w/Hose Kit	1.6	16.0	
N/P	I70 (.625) 1/2HP 12VDC Injector w/Hose Kit	2.5	25.0	
001-036	I70 (.75) 1/2HP 12VDC Injector w/Hose Kit	3.6	36.0	
014-026	HVI-88 1/2HP 12VDC Injector w/Hose Kit	6.0	60.0	
007-014	HVI-82 3/4HP 12VDC Injector w/Hose Kit	11.4	114.0	
015-060	IOM-96 3/4HP 12VDC Injector w/Hose Kit	20.0	200.00	



INJECT-O-METER - BELT DRIVEN PUMPS - DUPLEX @ 1725 RPM

Part No.	Description	Min. GPH Output	Max. GPH Output	Price
001-081	I70 (.25) w/Hose Kit & Mounting Bracket	.40	4.0	
001-069	I70 (.375) w/Hose Kit & Mounting Bracket	.90	9.0	
001-057	I70 (.50) w/Hose Kit & Mounting Bracket	1.6	16.0	
001-045	I70 (.625) w/Hose Kit & Mounting Bracket	2.5	25.0	
001-005	I70 (.75) w/Hose Kit & Mounting Bracket	3.6	36.0	
014-002	HVI-88 w/Hose Kit & Mounting Bracket	6.0	60.0	
007-010	HVI-82 w/Hose Kit & Mounting Bracket	11.4	114.0	
015-030	IOM-96 w/Hose Kit & Mounting Bracket	15.2	152.0	



We carry the complete line of inject-o-meter whole goods and parts, including acid injection pumps. If you do not find what you are looking for in this section, please call us to discuss your individual needs.

INTRO
1. ELECTRICAL
2. PUMP ACC.
3. HOSE, PE PIPE & ACC.
4. IPS, PIP PIPE & ACC.
5. SURFACE
6. SPRINKLERS
7. TRAVELER & WHEEL MOVE
8. PIVOT
9. TURF
10. LOW VOLUME
11. FILTERS
12. INJECTION
13. HARDWARE
INDEX

INJECT-O-METER CHEMIGATION SYSTEMS

INJECT-O-METER - CHEMIGATION SYSTEM WITH TANK - SIMPLEX - SINGLE PHASE

Part No.	Description	HP	Min. GPH Output	Max. GPH Output	Price
001-180-65-CS	I70 (.25) 1PH 65 Gal. Tank - Mechanical Agitator	1/3	.20	2.00	
001-180-110-CS	I70 (.25) 1PH 110 Gal. Tank - Mechanical Agitator	1/3	.20	2.00	
001-181-65-CS	I70 (.375) 1PH 65 Gal. Tank - Mechanical Agitator	1/3	.45	4.5	
001-181-110-CS	I70 (.375) 1PH 110 Gal. Tank - Mechanical Agitator	1/3	.45	4.5	
001-182-65-CS	I70 (.50) 1PH 65 Gal. Tank - Mechanical Agitator	1/3	.80	8.0	
001-182-110-CS	I70 (.50) 1PH 110 Gal. Tank - Mechanical Agitator	1/3	.80	8.0	
001-183-65-CS	I70 (.625) 1PH 65 Gal. Tank - Mechanical Agitator	1/3	1.25	12.5	
001-183-110-CS	I70 (.625) 1PH 110 Gal. Tank - Mechanical Agitator	1/3	1.25	12.5	
001-184-65-CS	I70 (.75) 1PH 65 Gal. Tank - Mechanical Agitator	1/3	1.80	18.0	
001-184-110-CS	I70 (.75) 1PH 110 Gal. Tank - Mechanical Agitator	1/3	1.80	18.0	
007-003-65-CS	HVI-82 1PH 65 Gal. Tank - Mechanical Agitator	1/3	5.70	57.0	
007-003-110-CS	HVI-82 1PH 110 Gal. Tank - Mechanical Agitator	1/3	5.70	57.0	



INJECT-O-METER - CHEMIGATION SYSTEM WITH TANK - SIMPLEX - 3 PHASE

Part No.	Description	HP	Min. GPH Output	Max. GPH Output	Price
001-175-65-CS	I70 (.25) 3PH 65 Gal. Tank - Mechanical Agitator	1/3	.20	2.00	
001-175-110-CS	I70 (.25) 3PH 110 Gal. Tank - Mechanical Agitator	1/3	.20	2.00	
001-176-65-CS	I70 (.375) 3PH 65 Gal. Tank - Mechanical Agitator	1/3	.45	4.5	
001-176-110-CS	I70 (.375) 3PH 110 Gal. Tank - Mechanical Agitator	1/3	.45	4.5	
001-177-65-CS	I70 (.50) 3PH 65 Gal. Tank - Mechanical Agitator	1/3	.80	8.0	
001-177-110-CS	I70 (.50) 3PH 110 Gal. Tank - Mechanical Agitator	1/3	.80	8.0	
001-178-65-CS	I70 (.625) 3PH 65 Gal. Tank - Mechanical Agitator	1/3	1.25	12.5	
001-178-110-CS	I70 (.625) 3PH 110 Gal. Tank - Mechanical Agitator	1/3	1.25	12.5	
001-179-65-CS	I70 (.75) 3PH 65 Gal. Tank - Mechanical Agitator	1/3	1.80	18.0	
001-179-110-CS	I70 (.75) 3PH 110 Gal. Tank - Mechanical Agitator	1/3	1.80	18.0	
007-001-65-CS	HVI-82 3PH 65 Gal. Tank - Mechanical Agitator	1/3	5.70	57.0	
007-001-110-CS	HVI-82 3PH 110 Gal. Tank - Mechanical Agitator	1/3	5.70	57.0	



INJECT-O-METER CHEMIGATION SYSTEMS

INJECT-O-METER - CHEMIGATION SYSTEM WITH TANK - DUPLEX - SINGLE PHASE

Part No.	Description	HP	Min. GPH Output	Max. GPH Output	Price
001-208-65-CS	I70 (.75) (.25) 1PH 65 Gal. Tank - Mechanical Agitator & Discharge Kit	1/3	.20	20.0	
001-208-110-CS	I70 (.75) (.25) 1PH 110 Gal. Tank - Mechanical Agitator & Discharge Kit	1/3	.20	20.0	
001-207-65-CS	I70 (.75) (.375) 1PH 65 Gal. Tank - Mechanical Agitator & Discharge Kit	1/3	.45	22.5	
001-207-110-CS	I70 (.75) (.375) 1PH 110 Gal. Tank - Mechanical Agitator & Discharge Kit	1/3	.45	22.5	
001-222-65-CS	I70 (.75) (.50) 1PH 65 Gal. Tank - Mechanical Agitator & Discharge Kit	1/3	.80	26.0	
001-222-110-CS	I70 (.75) (.50) 1PH 110 Gal. Tank - Mechanical Agitator & Discharge Kit	1/3	.80	26.0	
NO P/N-65-CS	I70 (.75) (.625) 1PH 65 Gal. Tank - Mechanical Agitator & Discharge Kit	1/3	1.25	30.5	
NO P/N-110-CS	I70 (.75) (.625) 1PH 110 Gal. Tank - Mechanical Agitator & Discharge Kit	1/3	1.25	30.5	
NO P/N-65-CS	I70 HVI-88 1PH 65 Gal. Tank - Mechanical Agitator & Discharge Kit	1/3	*.20	*48.0	
NO P/N-110-CS	I70 HVI-88 1PH 110 Gal. Tank - Mechanical Agitator & Discharge Kit	1/3	*.20	*48.0	
001-215-65-CS	I70 HVI-82 1PH 65 Gal. Tank - Mechanical Agitator & Discharge Kit	1/3	*.20	*75.0	
001-215-110-CS	I70 HVI-82 1PH 110 Gal. Tank - Mechanical Agitator & Discharge Kit	1/3	*.20	*75.0	
014-011-65-CS	HVI-88 1PH 65 Gal. Tank - Mechanical Agitator & Discharge Kit	1/3	.30	60.0	
014-011-110-CS	HVI-88 1PH 110 Gal. Tank - Mechanical Agitator & Discharge Kit	1/3	.30	60.0	
007-003-65-CS	HVI-82 1PH 65 Gal. Tank - Mechanical Agitator & Discharge Kit	1/3	5.7	114.0	
007-003-110-CS	HVI-82 1PH 110 Gal. Tank - Mechanical Agitator & Discharge Kit	1/3	5.7	114.0	



INJECT-O-METER - CHEMIGATION SYSTEM WITH TANK - DUPLEX - 3 PHASE

Part No.	Description	HP	Min. GPH Output	Max. GPH Output	Price
001-204-65-CS	I70 (.75) (.25) 3PH 65 Gal. Tank - Mechanical Agitator & Discharge Kit	1/3	.20	20.0	
001-204-110-CS	I70 (.75) (.25) 3PH 110 Gal. Tank - Mechanical Agitator & Discharge Kit	1/3	.20	20.0	
001-201-65-CS	I70 (.75) (.375) 3PH 65 Gal. Tank - Mechanical Agitator & Discharge Kit	1/3	.45	22.5	
001-201-110-CS	I70 (.75) (.375) 3PH 110 Gal. Tank - Mechanical Agitator & Discharge Kit	1/3	.45	22.5	
001-205-65-CS	I70 (.75) (.50) 3PH 65 Gal. Tank - Mechanical Agitator & Discharge Kit	1/3	.8	26.0	
001-205-110-CS	I70 (.75) (.50) 3PH 110 Gal. Tank - Mechanical Agitator & Discharge Kit	1/3	.8	26.0	
001-202-65-CS	I70 (.75) (.625) 3PH 65 Gal. Tank - Mechanical Agitator & Discharge Kit	1/3	1.25	30.5	
001-202-110-CS	I70 (.75) (.625) 3PH 110 Gal. Tank - Mechanical Agitator & Discharge Kit	1/3	1.25	30.5	
001-224-65-CS	I70 HVI-88 3PH 65 Gal. Tank - Mechanical Agitator & Discharge Kit	1/3	*.20	*48.0	
001-224-110-CS	I70 HVI-88 3PH 110 Gal. Tank - Mechanical Agitator & Discharge Kit	1/3	*.20	*48.0	
001-223-65-CS	I70 HVI-82 3PH 65 Gal. Tank - Mechanical Agitator & Discharge Kit	1/3	*.20	*75.0	
001-223-110-CS	I70 HVI-82 3PH 110 Gal. Tank - Mechanical Agitator & Discharge Kit	1/3	*.20	*75.0	



Note: Minimum GPH output based on simplex operation and max. GPH output based on duplex operation. If you would like assistance in selecting the right pump for your job requirements, please give us a call.

INTRO
 1. ELECTRICAL
 2. PUMP ACC.
 3. HOSE, PE PIPE & ACC.
 4. IPS, PIP PIPE & ACC.
 5. SURFACE
 6. SPRINKLERS
 7. TRAVELER & WHEEL MOVE
 8. PIVOT
 9. TURF
 10. LOW VOLUME
 11. FILTERS
 12. INJECTION
 13. HARDWARE
 INDEX

EZ-FLO FERTIGATION SYSTEM

Automatically feeds all the plant material every time you water.

For commercial landscapes, residential landscapes, homeowners' associations, model homes, golf course and grower applications. These systems normally install directly in the irrigation system mainline downstream of the backflow preventer. One system can feed both sprinkler and drip irrigation zones without requiring any adjustments.

Easy to install – Easy to use

EZ-FLO systems can be installed in minutes. Any liquid or water soluble fertilizer or water-borne supplement can be delivered - no pre-mixing required. Simply fill the system periodically and it spoon feeds your landscape every time you water. The refill frequency is based on desired results, landscape size, fertilizer concentration and watering schedules.

EZ-FLO is Easy to Use and Maintain

EZ-FLO's patented dispensers "micro-dose" fertilizers and landscape products (liquids or water solubles) every time you water. The units can be adjusted from ratios of 400 to 1 down to 15,000 to 1 (or anywhere in between) simply by moving the cap knob between the Fast and Slow setting. Since EZ-FLO has no moving parts and works using pressure differentials created at the connection point, these units are extremely reliable and trouble free and provide years of service. But don't let EZ-FLO's apparent simplicity fool you. These units are in use in demanding applications like The Rose Bowl, The Bellagio Hotel in Las Vegas, The Smithsonian Institute and other prestigious landscapes.

Save Money Over Granular Applications of Fertilizer

EZ-FLO saves money by reducing fertilizer applied, reducing the need for as much water and by eliminating the labor needed for applying fertilizers. Less fertilizer is needed since plants can absorb almost 100% of fertilizer when applied in small doses continuously when you water. The only labor involved is refilling the unit which takes minutes vs. hours to manually fertilize most properties. And less water can be used since plants develop increased root mass when fed in micro-doses.



EZ-FLO SYSTEM

Part No.	Landscape Size	Liquid	Water Soluble Fertilizer	Price
EZ001-CX	6,000 - 10,000 Sq. Ft.	1.5 Gallons	10 - 12 Lbs.	
EZ003-CX	10,000 - 17,000 Sq. Ft.	2.5 Gallons	15 - 18 Lbs.	
EZ005-FX	17,000 - 30,000 Sq. Ft.	4.25 Gallons	25 - 30 Lbs.	
EZ010-FX	30,000 - 63,000 Sq. Ft.	9.4 Gallons	50 - 60 Lbs.	
EZ010-HC	63,000 - 200,000 Sq. Ft..	10 Gallons	75 - 100 Lbs.	
EZ017-HC	200,000 - 400,000 Sq. Ft.	17.5 Gallons	150 - 200 Lbs.	
EZ025-HC 25	400,000 - 600,000 Sq. Ft.	25 Gallons	225 - 300 Lbs.	

Connection Options

Connecting an EZ-FLO unit to the irrigation piping is a breeze. Simply choose from one of the appropriate size connectors that matches your piping size. For simpler connections, EZ-FLO has a line of slip coupling connectors that can be glued into the PVC irrigation piping. If you use flexible poly piping, you would want to use threaded coupling connectors. Or if you are delivering heavier organic liquids or have low flow drip systems, you should consider a ball valve coupling connector which allows for even broader proportioning ranges and user control.

EZ-FLO CONNECTIONS

Pipe Size	Slip Coupling	Price	Ball Valve Coupling	Price	Threaded Coupling	Price
3/4"	C-075		CBV-075		CT-075	
1"	C-100		CBV-100		CT-100	
1-1/4"	C-125		CBV-125		-	
1-1/2"	C-150		CBV-150		-	
2"	C-200		CBV-200		-	
2-1/2"	-	-	CBV-250		-	
3"	-	-	CBV-300		-	
4"	-	-	CBV-400		-	



EZ-FLO FERTIGATION SYSTEM

EZ FLOW HOSE BIBB APPLICATOR

EZ-FLO is the fastest and easiest way to have a beautiful landscape and a healthy garden. EZ-FLO Hose and Drip Systems can be used with any liquid or water soluble fertilizer to feed through a garden hose, drip system or single irrigation zone. Maximum operating tank pressure is 80 PSI.

Part No.	Description	Price
EZ-2005-HB	Low Pressure Fertigation System Garden Hose Thread Applicator - 3/4" Gallon Tank	



ERATH EARTH FERTIGATION SYSTEM

COMPOST TEA

Part No.	Description	Price
COMPOST-T-GA	Organic Liquid Fertilizer made of Liquid Compost, Liquid Humate, Orange Oil, and Molasses - 1 Gallon	



ERATH EARTH COMPOST TEA EXTRACTOR & BREWING SYSTEMS

Organically producing rich soils and healthy plants by adding biology back to the land through the use of spraying and drenching with Compost Tea. With a blend of beneficial micro organisms and soluble nutrients available to the plant, compost tea suppresses plant diseases and gives plants the extra energy they need for vigorous growth.

We have systems from 5 to 1200 gpm serving everyone from small landscapers to thousand acre farms. Small and large volumes of compost tea all produced with our vortex technology that quickly oxygenates water and extracts biology and all soluble nutrients from compost with ease. Our automated systems give farmers the ability to get to the field on time without baby sitting complicated time consuming equipment. Our systems extract and brew with the same equipment, and the clean up is easy, no need for scrubbing or manually cleaning the tank.

High levels of dissolved oxygen are created by centrifugal force pulling ambient air from the atmosphere through the venturi effect the vortex of liquid creates. A spinning core of cool air is pulled into the vortex of liquid from the bottom, infusing oxygen into every drop of water, keeping the tea aerobic and at the best temperature for the beneficial microbes to thrive. As this air is pulled in, the air flow and the geometry of the vortex reverses 90% of the liquid back out the top. The Vortex is then made up of two spinning columns of water traveling against each other in opposite directions around a core of air creating a wrenching cyclone that perfectly extracts and brew compost tea.

This process can de-chlorinate water, extract all soluble nutrients & biology from compost, brew and make large batches of compost tea quickly, perfectly mix ingredients, oxygenate water, separate solids, deodorize and gas off anaerobic liquids and destroy plant pathogens. It even gives a mild paramagnetic charge to the solids passing through the vortex which has also been known to stimulate plant growth and maybe even help with freeze protection.



INJECTION EQUIPMENT

POLY TANKS

Clear Tank Part No.	Black Tank Part No.	Gallons	Diameter	Height	Weight	Price
T200VK	T200VBK	200	31"	69"	65 Lbs.	 Please Call for Pricing
T300VK	T300VBK	300	56"	34"	90 Lbs.	
T550VK	T550VBK	550	49"	72"	140 Lbs.	
T1000VK	T1000VBK	1000	64"	85"	190 Lbs.	
T1225VK	T1225VBK	1225	87"	54"	185 Lbs.	
T1600VK	T1600VBK	1600	87"	68"	240 Lbs.	
T1750VK	T1750VBK	1750	87"	74"	280 Lbs.	
T2500VK	T2500VBK	2500	96"	91"	425 Lbs.	
T3000VK	T3000VBK	3000	96"	107"	550 Lbs.	



MAZZEI® VENTURI INJECTOR - POLYPROPYLENE

Part No.	Model	Inlet/Outlet	Suction Port	Suction*	Min. Flow*	Price
14000003	484-PP	1/2" MNPT	1/4" MNPT & 1/4" Barb	4 GPH	2.7 GPM	
14000006	584-PP	3/4" MNPT	1/4" MNPT & 1/4" Barb	7 GPH	5.0 GPM	
14000009	1078-02-PP	1" MNPT	1/2" MNPT & 3/8" Barb	18 GPH	13.7 GPM	
14000010	1583A-PP	1-1/2" MNPT	1/2" MNPT & 1/2" Barb	65 GPH	26.9 GPM	
14000013	2081A-PP	2" MNPT	1-1/4" MNPT	280 GPH	83.0 GPM	

* Suction & flow based on inlet pressure of 35 PSI and outlet pressure of 25 PSI.



MAZZEI® HOOKUP KIT

Part No.	Model	Description	Price
14000403	K184-A	1/2" Injector Kit with Hose, Metering Valve, Strainer, Fittings	
14000404	K184-B	3/4" Injector Kit with Hose, Metering Valve, Strainer, Fittings	
14000405	K181-A	1" Injector Kit with Hose, Metering Valve, Strainer, Fittings	
14000406	K183-A	1-1/2" Injector Kit with Hose, Metering Valve, Strainer, Fittings	
14000407	K282-A	2" Injector Kit with Hose, Metering Valve, Strainer, Fittings	



CHEM-FEED® C-600P SERIES DIAPHRAGM METERING PUMP

Part No.	Max. GPH	GPD	Max. PSI	Price
C-6125P-115VAC	9.9	237	30	
C-6250P-115VAC	16.2	389	10	

- 115VAC/60Hz
- PVDF Molded Pump Head
- Each Unit is Factory Tested
- Simple Efficient Design
- Ease of Operation
- Minimum Maintenance
- Easy access, side mounted mechanical output rate adjustment



AMIAD® INJECTORS

Part No.	Description	Price
8-4010-0000	4-01 Injector - Suction Type	
8-4020-0000	4-02 Injector - Gravity Feed Type	
18-4011-11XX*	Complete Flow Regulator Kit: 1 Capsule	

*XX = 08 for 2 GPH - Red 60 for 15 GPH - Blue
 20 for 5 GPH - Yellow 80 for 20 GPH - Brown
 40 for 10 GPH - Green



WALCHEM INJECTION EQUIPMENT

These 115VAC electronic metering pumps have been designed to meet any precise chemical injection application. Manual or automatic mode features speed adjustment in one stroke/minute increments from 1 to 360, providing for smooth, uniform and precise chemical injection. The EZ pump is offered as a more economical option, while the EHE pump has been engineered and built to offer increased durability and performance. Please Note: The EWB Pump offered below is for injecting peroxide.

WALCHEM INJECTOR PUMPS

Part No.	Connection	Max. GPH	Max. Stroke	Max. PSI	Price
EZC36D1-PC	1/2" Tube	6.3	1.17 ML	30	
EHE36E1-PC	1/2" Tube	8.5	1.44 ML	105	
EHE36E1-PCT	3/4" MNPT	8.5	1.44 ML	105	
EHE46E1-PC	1/2" Tube	12.0	2.08 ML	60	
EHE46E1-PCT	3/4" MNPT	12.0	2.08 ML	60	
EWB11F1-VCA-H	3/8" Tube	0.6	.11 ML	150	



WALCHEM WPH400 SERIES CONTROLLER

Part No.	Descriptions	Price
WPH410-142U	pH Controller - 4-20mA Outputs / 115VAC	

The WPH410 Series pH/ORP Controller is configured to accurately measure pH or ORP values. The easy-to-use menu allows you to program up to 4 outputs in a variety of control modes. Additional features include:

- Dual pH or ORP electrode inputs allow one controller to take the place of two, thereby reducing cost.
- Versatility for a broad range of applications. Select from pH or ORP measurements & from 5 output options.
- The NEMA 4X enclosure is ideal for harsh environments.
- Built-in safety features such as programmable output limit timers prevent run-away chemical addition.
- Integrated datalogging is available by downloading stored data from the controller to a USB stick.
- Self-diagnostics - Software and electronics are constantly monitored.
- Self-test - Menu selectable self-test simulates pH and temperature signals, allowing for quick diagnosis of sensor or controller problems.
- Automatic probe wash feature for applications that require frequent electrode cleaning.



FULLY AUTOMATED pH MONITORING AND CONTROL SYSTEM

Part No.	Descriptions	Price
pHS	pH Monitoring and Control System 115VAC	

This unit is designed and built to incorporate an injection system with a pH probe and monitor to control the pH levels in your irrigation water through the introduction of acid, or an acid / fertilizer solution. This system can be used with either straight acid, or with a blend of nitrogen and sulfuric acid based fertilizer which several chemical manufacturers have developed and distribute for agricultural application, most commonly applied through drip or pivot irrigation. When the system is utilized to its full capability, it can provide many positive results that are derived from chemically treating the water and maintaining the desired pH level. One benefit includes irrigation system maintenance and cleaning - particularly important with drip systems by preventing calcium carbonate build-up and biological clogging from algae and/or root intrusion. Other benefits include the improved availability of Phosphorous and micronutrients to the plants, anticrustant and sodic soil remediation in calcareous soils, the potential to correct lime-induced iron chlorosis, and stubble digestion for small grains. Benefits that are geared toward enhancing quality, yield, production and profits. The system incorporates a heavy duty stand, which provides a strong and durable foundation to ensure system longevity, onto which the professional grade 115VAC 12 GPH pump and pH controller is mounted. The controller is installed in a durable high impact polycarbonate enclosure, rated Nema 4X, providing protection from dust, rain, sleet, snow, and UV exposure. The system is supplied with a pH probe for insertion in the mainline to acquire pH readings, a Mister Mist'r injection check valve that disbursts the chemical in a four-way spray that instantly atomizes the liquid being injected into the irrigation stream, and a pressure switch that will provide for a system shutdown feature, in the event of pressure loss due to well shutdown or a leak in the pipeline. Should your customer decide to do so, another pump can easily be mounted on the stand and connected to the controller for additional injection capacity. Installation accessories, such as "SERVICE SADDLES" on page 2:81, are available if needed.



Caution: Due to the caustic, corrosive and dangerous nature of sulfuric acid, and the wide range of adjustment available through the injection pump, we suggest that only a well educated and trained technician be obtained to install and set the operating parameters of the pump, to establish the desired pH levels and to achieve the greatest benefit.

1. ELECTRICAL
2. PUMP Acc.
3. HOSE, PE Pipe & Acc.
4. IPS, PIP Pipe & Acc.
5. SURFACE
6. SPRINKLERS
7. TRAVELER & WHEEL MOVE
8. PIVOT
9. TURF
10. LOW VOLUME
11. FILTERS
12. INJECTION
13. HARDWARE
INDEX

HANNA® INSTRUMENTS pH TESTERS & METERS

pH MULTIPARAMETER TESTERS

Part No.		Price
HI98128	pHep®5 pH / Temperature Tester 0.01 pH Resolution	
HI98129	pH / Conductivity / TDS / Temperature Tester Low Range EC Measurement	

Common Features:

- Waterproof and designed to float
- Automatic Temperature Compensation
- Automatic calibration
- Tactile grip casings
- Hold function
- Automatic shut-off
- Efficient two button operation
- Battery % displayed at startup
- BEPS (Battery Error Prevention System)
- Temperature in °C or °F

HI98128

The HI98128 is for users that require the greatest accuracy and features while staying economical. In addition to the features listed above, this tester has a replaceable pH electrode cartridge. The HI98128 is supplied with HI73127 pH electrode, HI73128 electrode removal tool, batteries and instructions.

HI98129

The HI98129 is a high accuracy multi-functional tester. No more switching between meters for your routine measurements. In addition to the features listed above, this tester features a replaceable pH electrode cartridge with an extendable cloth junction as well as an EC/TDS graphite electrode. The extendable cloth junction provides an extended electrode life and the replaceable pH cartridge means that this tester does not need to be thrown away when the pH sensor is exhausted. Fast, efficient, accurate and portable. The HI98129 is supplied with HI73127 pH electrode and HI73128 electrode removal tool, batteries and instructions.

HI98128
pHep®5 pH / Temperature Tester
0.01 pH Resolution



HI98129
pH / Conductivity / TDS Tester
Low Range EC Measurement



MULTIPARAMETER PORTABLE METERS

Part No.		Price
HI9125	Portable pH / ORP Meter	
HI9813-6	Portable pH / EC / TDS / Temperature Meter with Cal Check™ Feature	

Note: To conduct ORP readings on the HI9125, you will need the ORP Probe HI3131B.

Common Features:

- Water resistant
- On-screen tutorial messages for calibration
- BEPS (Battery Error Prevention System) alerts the user in the event that low battery power could adversely affect readings
- Automatic Temperature Compensation for pH
- Battery % displayed on startup

HI9125

In addition to the features above are: User-selectable “calibration time out”; and Automatic calibration. A large dual-level LCD displays both the pH and temperature along with an operational guide. Graphic symbols are displayed to help the users during the calibration process. This meter utilizes the HI1230B double junction pH electrode. This helps minimize junction contamination for accurate consistent results. The HI9125 is supplied with HI1230B electrode, HI7662 temperature probe, HI70004 pH 4.01 buffer solution sachet, HI70007 pH 7.01 buffer solution sachet, 100 mL plastic beaker, batteries, instructions and hard carrying case.

HI9813-6

This meter is specifically designed for agricultural applications such as farming, nurseries, greenhouses and hydroponics. In addition to the above listed features, the HI9813-6 features a large LCD that clearly displays the parameter being measured as well as calibration instructions. Calibration is fast and easy with knobs located on the front panel of the instrument. The Cal Check™ feature allows the user to easily check the pH probe calibration status at any time. The instrument utilizes the HI1285 series pH/EC/TDS/temperature probe. This probe features a fiber junction and gel electrolyte making it ideal for fertilizer solutions. The HI9813-6 is supplied with HI1285-6 multiparameter probe, HI70007 pH 7.01 calibration solution sachet, HI70442 1500 ppm (mg/L) calibration solution sachet, HI70031 1413 µS/cm calibration solution sachet, 700521 electrode cleaning solution sachets (2), battery, instructions and rugged carrying case.

HI9125
Portable pH / ORP Meter



HI9813-6
Portable pH / EC / TDS /
Temperature Meter



HANNA® INSTRUMENTS SOLUTIONS & ACCESSORIES

SOLUTIONS, ELECTRODES & PROBE

Part No.	Description	Box Qty	Price
*HI70004P	4.01 pH Buffer Solution – 20 mL Sachets	25	
HI7004L	4.01 pH Buffer Solution – 500 mL Bottle	1	
*HI77400C	Combination pH Buffer Kit – 4.01 & 7.01 pH w/ Certificate – 10 ea. 20mL Sachets	20	
HI70006P	6.86 pH Buffer Solution – 20 mL Sachets	25	
HI7006L	6.86 pH Buffer Solution – 500 mL Bottle	1	
*HI70007P	7.01 pH Buffer Solution – 20 mL Sachets	25	
HI7007L	7.01 pH Buffer Solution – 500 mL Bottle	1	
HI70009P	9.18 pH Buffer Solution – 20 mL Sachets	25	
HI70010P	10.01 pH Buffer Solution – 20 mL Sachets	25	
HI77100C	1413 µS/cm EC Solution & pH 7.01 Buffer Sachet Kit w/ Certificate, 10 ea. 20 mL Sachets	20	
HI70031P	1413 µS/cm EC Solution – 20 mL Sachets	25	
HI70442P	1500 mg/L (ppm) TDS Solution – 20 mL Sachets	25	
HI73127	Spare Electrode for Testers for HI98129 & HI98128	1	
HI1230B	Combination pH Electrode for Field Applications for HI9125	1	
HI3131B	Refillable Combination ORP Electrode for Titration and Laboratory Use for HI9125	1	
HI7662	Stainless Steel Temperature Probe for HI9125	1	

*Note: The 4.01 and 7.01 pH Buffer Solution Sachets are the most widely used for pH. More items and information are available upon request.



HI70004P



HI7004L



HI77400C



HI70006P



HI7006L



*HI70007P



HI7007L



HI70009P



HI70010P



HI77100C



HI70031P



HI70442P



HI73127



HI1230B



HI3131B



HI7662

POLYPROPYLENE QUICK-ACTING FITTINGS



TYPE A -
Male Adapter x FIPT

Part No.	Size	Price
75A1/2	1/2" x 1/2"	
75A3/4	3/4"	
100A	1"	
125A	1-1/4"	
150A	1-1/2"	
200A	2"	
300A	3"	
400A	4"	



TYPE B -
Female Coupler x MIPT

Part No.	Size	Price
75B1/2	1/2" x 1/2"	
75B3/4	3/4"	
100B	1"	
125B	1-1/4"	
150B	1-1/2"	
200B	2"	
300B	3"	
400B	4"	



TYPE C -
Female Coupler x Hose Shank

Part No.	Size	Price
050C	1/2" x 1/2"	
075C	3/4"	
100C	1"	
125C	1-1/4"	
150C	1-1/2"	
200C	2"	
300C	3"	
400C	4"	



TYPE D -
Female Coupler x FIPT

Part No.	Size	Price
050D	1/2" x 1/2"	
075D	3/4"	
100D	1"	
125D	1-1/4"	
150D	1-1/2"	
200D	2"	
300D	3"	
400D	4"	



TYPE E -
Male Adapter x Hose Shank

Part No.	Size	Price
050E	1/2" x 1/2"	
075E	3/4"	
100E	1"	
125E	1-1/4"	
150E	1-1/2"	
200E	2"	
300E	3"	
400E	4"	



TYPE F -
Male Adapter x MIPT

Part No.	Size	Price
050F	1/2" x 1/2"	
075F	3/4"	
100F	1"	
125F	1-1/4"	
150F	1-1/2"	
200F	2"	
300F	3"	
400F	4"	



TYPE DC -
Dust Cap

Part No.	Size	Price
075CAP	1/2" x 1/2"	
075CAP	3/4"	
100125CAP	1"	
100125CAP	1-1/4"	
150CAP	1-1/2"	
200CAP	2"	
300CAP	3"	
400CAP	4"	



TYPE DP -
Dust Plug

Part No.	Size	Price
75PL	1/2" x 1/2"	
75PL	3/4"	
100125PL	1"	
100125PL	1-1/4"	
150PL	1-1/2"	
200PL	2"	
300PL	3"	
400PL	4"	



TYPE A90 -
90° Male Adapter x FIPT

Part No.	Size	Price
150A90	1-1/2"	
200A90	2"	



TYPE C90 -
90° Female Coupler x Hose Shank

Part No.	Size	Price
150C90	1-1/2"	
200C90	2"	



TYPE D90 -
90° Female Coupler x FIPT

Part No.	Size	Price
150D90	1-1/2"	
200D90	2"	



TYPE F90 -
90° Male Adapter x MIPT

Part No.	Size	Price
150F90	1-1/2"	
200F90	2"	

POLYPROPYLENE PIPE THREAD FITTINGS



TEE

Part No.	Size	Price
TEE038	3/8"	
TEE050	1/2"	
TEE075	3/4"	
TEE100	1"	
TEE125	1-1/4"	
TEE150	1-1/2"	
TEE200	2"	
TEE300	3"	



45° STREET ELBOW

Part No.	Size	Price
SL075-45	3/4"	
SL100-45	1"	
SL125-45	1-1/4"	
SL150-45	1-1/2"	
SL200-45	2"	
SL300-45	3"	



REDUCING COUPLING

Part No.	Size	Price
RC100-075	1" x 3/4"	
RC150-100	1-1/2" x 1"	
RC150-125	1-1/2" x 1-1/4"	
RC200-050	2" x 1/2"	
RC200-100	2" x 1"	
RC200-125	2" x 1-1/4"	
RC200-150	2" x 1-1/2"	
RC300-200	3" x 2"	



90° ELBOW

Part No.	Size	Price
EL038-90	3/8"	
EL050-90	1/2"	
EL075-90	3/4"	
EL100-90	1"	
EL125-90	1-1/4"	
EL150-90	1-1/2"	
EL200-90	2"	
EL300-90	3"	



CROSS

Part No.	Size	Price
CR050	1/2"	
CR075	3/4"	
CR100	1"	
CR125	1-1/4"	
CR150	1-1/2"	
CR200	2"	



REDUCER BUSHING

Part No.	Size	Price
RB038-025	3/8" x 1/4"	
RB050-025	1/2" x 1/4"	
RB050-038	1/2" x 3/8"	
RB075-018	3/4" x 1/8"	
RB075-025	3/4" x 1/4"	
RB075-038	3/4" x 3/8"	
RB075-050	3/4" x 1/2"	
RB100-018	1" x 1/8"	
RB100-025	1" x 1/4"	
RB100-050	1" x 1/2"	
RB100-075	1" x 3/4"	
RB125-038	1-1/4" x 3/8"	
RB125-075	1-1/4" x 3/4"	
RB125-100	1-1/4" x 1"	
RB150-075	1-1/2" x 3/4"	
RB150-100	1-1/2" x 1"	
RB150-125	1-1/2" x 1-1/4"	
RB200-075	2" x 3/4"	
RB200-100	2" x 1"	
RB200-125	2" x 1-1/4"	
RB200-150	2" x 1-1/2"	
RB300-150	3" x 1-1/2"	
RB300-200	3" x 2"	
RB400-300	4" x 3"	



90° STREET ELBOW

Part No.	Size	Price
SL038-90	3/8"	
SL050-90	1/2"	
SL075-90	3/4"	
SL100-90	1"	
SL125-90	1-1/4"	
SL150-90	1-1/2"	
SL200-90	2"	
SL300-90	3"	



COUPLING

Part No.	Size	Price
CPLG038	3/8"	
CPLG050	1/2"	
CPLG075	3/4"	
CPLG100	1"	
CPLG125	1-1/4"	
CPLG150	1-1/2"	
CPLG200	2"	
CPLG300	3"	

POLYPROPYLENE PIPE THREAD FITTINGS

NIPPLES

Part No.	Size	Price
NIP025-SH	1/4" x Short	
NIP038-SH	3/8" x Short	
NIP050-SH	1/2" x Short	
NIP050-3	1/2" x 3"	
NIP075-SH	3/4" x Short	
NIP075-4	3/4" x 4"	
NIP075-6	3/4" x 6"	
NIP100-SH	1" x Short	
NIP100-4	1" x 4"	
NIP100-6	1" x 6"	
NIP125-SH	1-1/4" x Short	
NIP125-4	1-1/4" x 4"	
NIP125-6	1-1/4" x 6"	
NIP150-SH	1-1/2" x Short	
NIP150-3	1-1/2" x 3"	
NIP150-4	1-1/2" x 4"	
NIP150-5	1-1/2" x 5"	
NIP150-6	1-1/2" x 6"	
NIP200-SH	2" x Short	
NIP200-4	2" x 4"	
NIP200-6	2" x 6"	
NIP300-SH	3" x Short	
NIP300-4	3" x 4"	
NIP300-6	3" x 6"	
NIP400-SH	4" x Short	



CAP

Part No.	Size	Price
CAP050	1/2"	
CAP075	3/4"	
CAP100	1"	
CAP125	1-1/4"	
CAP150	1-1/2"	
CAP200	2"	
CAP300	3"	



PLUG

Part No.	Size	Price
PLUG050	1/2"	
PLUG075	3/4"	
PLUG100	1"	
PLUG125	1-1/4"	
PLUG150	1-1/2"	
PLUG200	2"	
PLUG300	3"	



MANIFOLD

Part No.	Size	Price
TM075/050	3/4" In x 1/2" Out 8 Station Manifold	



BULKHEAD FITTINGS

Part No.	Size	Hole Size	Price
TF050	1/2"	1-5/8"	
TF075	3/4"	1-5/8"	
TF100	1"	2-1/4"	
TF125	1-1/4"	2-1/4"	
TF150	1-1/2"	3"	
TF200	2"	3"	
TF220	2"	3-1/4"	
TF300	3"	4-1/2"	



REDUCER NIPPLES

Part No.	Size	Price
RN050-038	1/2" x 3/8"	
RN075-050	3/4" x 1/2"	
RN100-050	1" x 1/2"	
RN100-075	1" x 3/4"	
RN125-075	1-1/4" x 3/4"	
RN125-100	1-1/4" x 1"	
RN150-100	1-1/2" x 1"	
RN150-125	1-1/2" x 1-1/4"	
RN200-125	2" x 1-1/4"	
RN200-150	2" x 1-1/2"	
RN300-200	3" x 2"	



BULKHEAD FITTING GASKETS

Part No.	Fitting Size	Hole Size	Type	Price
150G	1/2" & 3/4"	1-5/8"	EPDM	
150GV	1/2" & 3/4"	1-5/8"	VITON	
200G	1" & 1-1/4"	2-1/4"	EPDM	
200GV	1" & 1-1/4"	2-1/4"	VITON	
300G	1-1/2" & 2"	3"	EPDM	
300GV	1-1/2" & 2"	3"	VITON	
TF220G	2"	3-1/4"	EPDM	
TF220GV	2"	3-1/4"	VITON	
TF300G	3"	4-1/2"	EPDM	
TF300GV	3"	4-1/2"	VITON	



POLYPROPYLENE HOSE BARB FITTINGS

FEATURES

- Precision molded in polypropylene
- Glass reinforced for stability, strength and toughness
- Hose barbs are molded specifically to fit properly into hoses

- Combination sizes available for elbows and straight barbs
- Excellent chemical resistance
- Pressure to 150 PSI at 70° F

POLY STRAIGHT HOSE BARB (MIPT X HOSE BARB)

Part No.	Size	Price
HB025	1/4" x 1/4"	
HB025-038	1/4" x 3/8"	
HB025-050	1/4" x 1/2"	
HB038	3/8" x 3/8"	
HB038-050	3/8" x 1/2"	
HB050-038	1/2" x 3/8"	
HB050	1/2" x 1/2"	
HB050-075	1/2" x 3/4"	
HB075-038	3/4" x 3/8"	
HB075-050	3/4" x 1/2"	
HB075-058	3/4" x 5/8"	
HB075	3/4" x 3/4"	
HB075-100	3/4" x 1"	
HB100-075	1" x 3/4"	
HB100	1" x 1"	
HB100-125	1" x 1-1/4"	
HB125-075	1-1/4" x 3/4"	
HB125-100	1-1/4" x 1"	
HB125	1-1/4" x 1-1/4"	
HB125-150	1-1/4" x 1-1/2"	
HB150-100	1-1/2" x 1"	
HB150-125	1-1/2" x 1-1/4"	
HB150	1-1/2" x 1-1/2"	
HB150-200	1-1/2" x 2"	
HB200-150	2" x 1-1/2"	
HB200	2" x 2"	
HB300	3" x 3"	
HB400	4" x 4"	



POLY HOSE BARB THREADED TEE (BARB X BARB X MIPT)

Part No.	Size	Price
HBT100-100	1" x 1" x 1"	
HBT150-100	1-1/2" x 1-1/2" x 1"	
HBT150-150	1-1/2" x 1-1/2" x 1-1/2"	



POLY ELBOW 90° (HOSE BARB)

Part No.	Size	Price
HBEL100-90	1" x 1"	



POLY ELBOW 90° (HOSE BARB X MIPT)

Part No.	Size	Price
HBEL150/100-90	1-1/2" x 1"	



POLY 90° HOSE BARB (MIPT X BARB)

Part No.	Size	Price
HB025-90	1/4" x 1/4"	
HB025/038-90	1/4" x 3/8"	
HB025/050-90	1/4" x 1/2"	
HB038-90	3/8" x 3/8"	
HB050/038-90	1/2" x 3/8"	
HB050-90	1/2" x 1/2"	
HB050/075-90	1/2" x 3/4"	
HB075/050-90	3/4" x 1/2"	
HB075-90	3/4" x 3/4"	
HB075/100-90	3/4" x 1"	
HB100/075-90	1" x 3/4"	
HB100-90	1" x 1"	
HB100/125-90	1" x 1-1/4"	
HB125/100-90	1-1/4" x 1"	
HB125-90	1-1/4" x 1-1/4"	
HB125/150-90	1-1/4" X 1-1/2"	
HB150/125-90	1-1/2" x 1-1/4"	
HB150-90	1-1/2" x 1-1/2"	
HB200/150-90	2" x 1-1/2"	
HB200-90	2" x 2"	
HB300-90	3" x 3"	



POLY FEMALE HOSE BARB (FIPT X HOSE BARB)

Part No.	Size	Price
HBF075	3/4" x 3/4"	
HBF075-100	3/4" x 1"	
HBF100	1" x 1"	



POLY HOSE BARB TEE (BARB X BARB X BARB)

Part No.	Size	Price
HBT050-038	1/2" x 1/2" x 3/8"	
HBT050-075	1/2" x 1/2" x 3/4"	
HBT075-050	3/4" x 3/4" x 1/2"	
HBT075	3/4" x 3/4" x 3/4"	
HBT075-100	3/4" x 3/4" x 1"	
HBT100-075	1" x 1" x 3/4"	
HBT100	1" x 1" x 1"	



POLY HOSE MENDER (BARB X BARB)

Part No.	Size	Price
HM050	1/2" x 1/2"	
HM075	3/4" x 3/4"	
HM100	1" x 1"	
HM125	1-1/4" x 1-1/4"	
HM150	1-1/2" x 1-1/2"	
HM200	2" x 2"	
HM300	3" x 3"	



INTRO
1. ELECTRICAL
2. PUMP Acc.
3. HOSE, PE PIPE & Acc.
4. IPS, PIP Pipe & Acc.
5. SURFACE
6. SPRINKLERS
7. TRAVELER & WHEEL MOVE
8. PIVOT
9. TURF
10. LOW VOLUME
11. FILTERS
12. INJECTION
13. HARDWARE
INDEX

SECTION 13

Hardware

CONTENTS

- 13:3 HARDWARE NOTES
- 13:4 CHAIN, WIRE ROPE & ACCESSORIES
- 13:5 CHAIN, WIRE ROPE & ACCESSORIES
- 13:6-9 NUTS & BOLTS
- 13:10-12 OUTDOOR LANDSCAPE TOOLS
- 13:13-16 PROFESSIONAL HAND TOOLS
 - 13:13 GREENLEE® SCREWDRIVER & NUT DRIVER SETS
 - 13:13 GREENLEE® INSULATED SCREWDRIVER & NUT DRIVER SETS
 - 13:14 GREENLEE® 6-IN-1 MULTI-TOOL
 - 13:14 GREENLEE® 7-PIECE COMBINATION RATCHETING WRENCH SET - STANDARD
 - 13:14 GREENLEE® COMPOSITE HANDLE ADJUSTABLE WRENCH
 - 13:14 GREENLEE® DRILL TAP AND HOLE SAW KITS
 - 13:15 GREENLEE® LONG NOSE AND DIAGONAL CUTTING PLIERS
 - 13:15 GREENLEE® PUMP PLIERS
 - 13:16 GREENLEE® POCKET-LIGHT FLASHLIGHT
 - 13:16 GREENLEE® KEYHOLE SAW
 - 13:16 GREENLEE® UTILITY KNIFE
 - 13:16 GREENLEE® TOOL BAGS
- 13:17-18 ECONOMY HAND TOOLS
 - 13:19 GLOVES & TIE DOWNS
 - 13:20 HAND PUMPS & SPRAYERS
 - 13:21 TRANSFER PUMPS
 - 13:21 TRANSFER PUMPS
 - 13:21 BANJO POLY PUMPS
- 13:22-23 MARKING ACCESSORIES



CHAIN - ELECTRO-GALVANIZED PROOF COIL

Part No.	Description	Price
316EG28	3/16" x 750' Galvanized Proof Coil	
316EG28FT	3/16" x Ft. Galvanized Proof Coil	
14EG28	1/4" x 400' Galvanized Proof Coil	
14EG28FT	1/4" x Ft. Galvanized Proof Coil	
516EG28	5/16" x 275' Galvanized Proof Coil	
516SC28	5/16" x 550' Galvanized Proof Coil	
516EG28FT	5/16" x Ft. Galvanized Proof Coil	
38EG28	3/8" x 200' Galvanized Proof Coil	
38EG28FT	3/8" x Ft. Galvanized Proof Coil	

Other sizes and grades of chain are available. Please call for more information.



TRANSPORT CHAIN

Part No.	Description	Price
332GC7Q-C	3/8" GRD 70 Transport Chain x 400	
38SCG70/C	3/8" GRD 70 Transport Chain x 200	
38SCG70FT	3/8" GRD 70 Transport Chain x Ft	



WIRE ROPE - GALVANIZED & STAINLESS STEEL

Part No.	Description	Price
18GC7Q	1/8" x 1000' 7x7 Galvanized Wire Rope	
18GC75	1/8" x 2500' 7x7 Galvanized Wire Rope	
532GC7	5/32" x 5000' 7x7 Galvanized Wire Rope	
532SC704	5/32" x 5000' 7x7 Type 304 Stainless Steel Wire Rope	
316GC7Q	3/16" x 1000' 7x7 Galvanized Wire Rope	
316GC7T	3/16" x 250' 7x7 Galvanized Wire Rope	
316GC19DV	3/16" x 1000' 7x19 Galvanized Wire Rope Vinyl Coated to 1/4"	
14GC19S	1/4" x 500' 7x19 Galvanized Wire Rope	
14GC19T	1/4" x 250' 7x19 Galvanized Wire Rope	

Other sizes and grades of wire rope are available. Please call for more information.

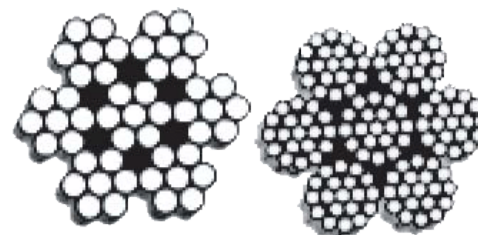

CHAIN AND WIRE ROPE ACCESSORIES

Part No.	Description	Price
43CGH14	1/4" Clevis Grab Hook Galvanized	
43CGH516	5/16" Clevis Grab Hook Galvanized	
43CGH38	3/8" Clevis Grab Hook Galvanized	
AS18	1/8" Aluminum Swage Sleeves	
AS532	5/32" Aluminum Swage Sleeves	
AS316	3/16" Aluminum Swage Sleeves	
AS14	1/4" Aluminum Swage Sleeves	
43005	CH 24" Swage Tool 100L 1/16" - 3/16" with Cutter	
THSC600	ARM 24" Swage Tool 100L 1/16" - 3/16" with Cutter	
THSC1000	40" Swage Tool 100L 1/4" - 5/16" with Cutter	
EGC18	1/8" Malleable Wire Rope Clips	
EGC316	3/16" Malleable Wire Rope Clips	
EGC14	1/4" Malleable Wire Rope Clips	



TURNBUCKLES & LOAD BINDERS

Part No.	Description	Price
HG3/8X6EE	3/8" x 6" Eye and Eye Turnbuckle Galvanized	
HG3/8X6HH	3/8" x 6" Hook and Hook Turnbuckle Galvanized	
HG38X6HE	3/8" x 6" Hook and Eye Turnbuckle Galvanized	
HG34X12HJ	3/4" x 12" Hook & Jaw Turnbuckle Galvanized	
HG34X12EE	3/4" x 12" Eye & Eye Turnbuckle Galvanized	
HG34X12HH	3/4" x 12" Hook & Hook Turnbuckle Galvanized	
HG34X12JJ	3/4" x 12" Jaw & Jaw Turnbuckle Galvanized	
HG1X6SE	1" x 6" Stub & Stub Turnbuckle Galvanized	
LL516	5/16" x 3/8" Lever Load Binder	
LL38	3/8" x 1/2" Lever Load Binder	
PRLB5.163.8	5/16" x 3/8" Ratchet Load Binder	

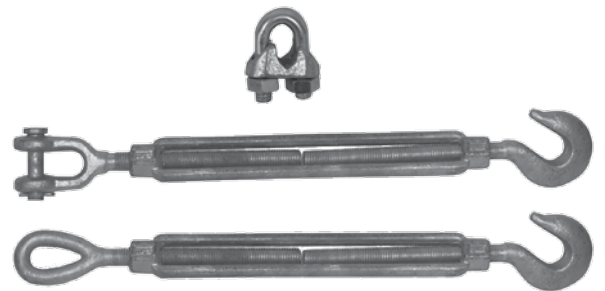

LOAD BINDERS

Part No.	Description	Price
LL516	5/16" x 3/8" Lever Load Binder	
LL38	3/8" x 1/2" Lever Load Binder	
PRLB5.163.8	5/16" x 3/8" Ratchet Load Binder	



NUTS & BOLTS

HEX CAP SCREW - GRADE 5 - ZINC PLATED

Part No.	Size	Each	Box		Carton	
			Qty.	Price	Qty.	Price
HBGR51/4x3/4	1/4" x 3/4"		100		4000	
HBGR51/4x1	1/4" x 1"		100		3600	
HBGR51/4x1-1/4	1/4" x 1-1/4"		100		2800	
HBGR51/4x1-1/2	1/4" x 1-1/2"		100		2400	
HBGR51/4x1-3/4	1/4" x 1-3/4"		100		1800	
HBGR51/4x2	1/4" x 2"		100		1600	
HBGR55/16x3/4	5/16" x 3/4"		100		2600	
HBGR55/16x1	5/16" x 1"		100		2200	
HBGR55/16x1-1/4	5/16" x 1-1/4"		100		1800	
HBGR55/16x1-1/2	5/16" x 1-1/2"		100		1600	
HBGR55/16x1-3/4	5/16" x 1-3/4"		100		1300	
HBGR55/16x2	5/16" x 2"		100		1200	
HBGR53/8X1	3/8" x 1"		100		1500	
HBGR53/8X1-1/4	3/8" x 1-1/4"		100		1300	
HBGR53/8X1-1/2	3/8" x 1-1/2"		100		1000	
HBGR53/8X1-3/4	3/8" x 1-3/4"		100		1000	
HBGR53/8X2	3/8" x 2"		100		800	
HBGR53/8X2-1/4	3/8" x 2-1/4"		50		700	
HBGR53/8X2-1/2	3/8" x 2-1/2"		50		650	
HBGR57/16X1	7/16" x 1"		100		600	
HBGR57/16X1-1/4	7/16" x 1-1/4"		50		850	
HBGR57/16X1-1/2	7/16" x 1-1/2"		50		750	
HBGR57/16X1-3/4	7/16" x 1-3/4"		50		650	
HBGR57/16X2	7/16" x 2"		50		600	
HBGR57/16X2-1/2	7/16" x 2-1/2"		50		450	
HBGR51/2X1	1/2" x 1"		50		750	
HBGR51/2X1-1/4	1/2" x 1-1/4"		50		650	
HBGR51/2X1-1/2	1/2" x 1-1/2"		50		600	
HBGR51/2X1-3/4	1/2" x 1-3/4"		50		500	
HBGR51/2X2	1/2" x 2"		50		450	
HBGR51/2X2-1/4	1/2" x 2-1/4"		50		400	
HBGR51/2X2-1/2	1/2" x 2-1/2"		50		325	
HBGR51/2X3	1/2" x 3"		50		300	
HBGR51/2X3-1/2	1/2" x 3-1/2"		25		250	
HBGR51/2X4	1/2" x 4"		25		200	
HBGR55/8X1	5/8" x 1"		25		400	
HBGR55/8X1-1/4	5/8" x 1-1/4"		25		350	
HBGR55/8X1-1/2	5/8" x 1-1/2"		25		300	
HBGR55/8X1-3/4	5/8" x 1-3/4"		25		300	
HBGR55/8X2	5/8" x 2"		25		250	
HBGR55/8X2-1/4	5/8" x 2-1/4"		25		225	
HBGR55/8X2-1/2	5/8" x 2-1/2"		25		200	
HBGR55/8X2-3/4	5/8" x 2-3/4"		25		200	
HBGR55/8X3	5/8" x 3"		25		175	
HBGR55/8X3-1/2	5/8" x 3-1/2"		25		150	
HBGR55/8X4	5/8" x 4"		25		125	
HBGR53/4X1-1/2	3/4" x 1-1/2"		20		200	
HBGR53/4X1-3/4	3/4" x 1-3/4"		20		200	
HBGR53/4X2	3/4" x 2"		20		180	
HBGR53/4X2-1/4	3/4" x 2-1/4"		20		150	
HBGR53/4X2-1/2	3/4" x 2-1/2"		20		140	
HBGR53/4X2-3/4	3/4" x 2-3/4"		20		130	
HBGR53/4X3	3/4" x 3"		20		120	
HBGR53/4X3-1/2	3/4" x 3-1/2"		20		100	
HBGR53/4X4	3/4" x 4"		20		85	
HBGR53/4X4-1/2	3/4" x 4-1/2"		20		80	



NUTS & BOLTS

HEX CAP SCREW - GRADE 8 - ZINC PLATED

Part No.	Size	Each	Box		Carton	
			Qty.	Price	Qty.	Price
HBGR83/4X2	3/4" x 2"		20		180	



HEX CAP SCREW - GRADE 5 - ZINC PLATED

Part No.	Size	Each	Box		Carton	
			Qty.	Price	Qty.	Price
HBGR53/4X5	3/4" x 5"		20		65	
HBGR53/4X5-1/2	3/4" x 5-1/2"		20		60	
HBGR53/4X6	3/4" x 6"		20		60	
HBGR53/4X6-1/2	3/4" x 6-1/2"		20		60	
HBGR53/4X7	3/4" x 7"		20		60	
HBGR53/4X8	3/4" x 8"		20		60	
HBGR53/4X8-1/2	3/4" x 8-1/2"		20		60	
HBGR51X3	1" x 3"		10		60	
HBGR51X6	1" x 6"		10		40	



HEX BOLT - GRADE 2 - ZINC PLATED

Part No.	Size	Each	Box		Carton	
			Qty.	Price	Qty.	Price
HBGR21/4x1	1/4" x 1"		100		2800	
HBGR23/8X1	3/8" x 1"		100		1500	
HBGR21/2X146TR	1/2" x 14"		25		90	
HBGR25/8X2	5/8" x 2"		25		250	
HBGR25/8X3	5/8" x 3"		25		175	
HBGR25/8X4	5/8" x 4"		25		125	
HBGR25/8X5	5/8" x 5"		25		90	
HBGR25/8X5-1/2	5/8" x 5-1/2"		25		75	
HBGR25/8X6	5/8" x 6"		25		75	
HBGR23/4X2	3/4" x 2"		20		180	
HBGR23/4X2-1/2	3/4" x 2-1/2"		20		140	
HBGR23/4X3	3/4" x 3"		20		120	
HBGR23/4X4	3/4" x 4"		20		85	
HBGR23/4X4-1/2	3/4" x 4-1/2"		20		80	
HBGR23/4X5	3/4" x 5"		20		65	
HBGR23/4X6	3/4" x 6"		20		60	
HBGR23/4X6-1/2	3/4" x 6-1/2"		20		60	
HBGR27/8X2	7/8" x 2"		10		120	
HBGR27/8X3	7/8" x 3"		10		90	
HBGR27/8X5	7/8" x 5"		10		50	
HBGR27/8X6	7/8" x 6"		10		40	
HBGR27/8X7-1/2	7/8" x 7-1/2"		10		45	
HBGR27/8X8	7/8" x 8"		10		40	
HBGR21X2-1/2	1" x 2-1/2"		10		60	
HBGR21X3	1" x 3"		10		60	
HBGR21X5	1" x 5"		10		40	
HBGR21X5-1/2	1" x 5-1/2"		10		40	
HBGR21X8	1" x 8"		10		30	
HBGR21-1/8X8	1-1/8" x 8"					



HEX TAP BOLT - ZINC PLATED

Part No.	Size	Each	Box		Carton	
			Qty.	Price	Qty.	Price
HTB3/8X5	3/8" x 5"		50		150	
HTB3/8X6	3/8" x 6"		50		150	
HTBGR53/8X6	3/8" x 6"		50		150	



INTRO
1. ELECTRICAL
2. PUMP Acc.
3. HOSE, PE PIPE & Acc.
4. IPS, PIP PIPE & Acc.
5. SURFACE
6. SPRINKLERS
7. TRAVELER & WHEEL MOVE
8. PIVOT
9. TURF
10. LOW VOLUME
11. FILTERS
12. INJECTION
13. HARDWARE
INDEX

NUTS & BOLTS

CARRIAGE BOLTS - GRADE 5 - ZINC PLATED

Part No.	Size	Each	Box		Carton	
			Qty.	Price	Qty.	Price
CBGR55/16x1-1/4	5/16" x 1-1/4"		100		1400	
CBGR55/16x1-1/2	5/16" x 1-1/2"		100		1100	



CARRIAGE BOLTS - GRADE 2 - ZINC PLATED

Part No.	Size	Each	Box		Carton	
			Qty.	Price	Qty.	Price
CBGR25/16x6	5/16" x 6"		50		300	
CBGR25/16x7	5/16" x 7"		50		300	
CBGR25/16x8	5/16" x 8"		50		300	
CBGR25/16x10	5/16" x 10"		100		250	
CBGR23/8x8	3/8" x 8"		50		200	
CBGR23/8x12	3/8" x 12"		50		180	



HEX NUT - ZINC PLATED

Part No.	Size	Each	Box		Carton	
			Qty.	Price	Qty.	Price
HN1/4	1/4"		100		9000	
HN5/16	5/16"		100		6000	
HN3/8	3/8"		100		4000	
HN7/16	7/16"		50		2200	
HN1/2	1/2"		50		1800	
HN5/8	5/8"		25		800	
HN3/4	3/4"		20		500	
HN7/8	7/8"		15		300	
HN1	1"		10		190	

NYLON LOCK NUT - ZINC PLATED

Part No.	Size	Each	Box		Carton	
			Qty.	Price	Qty.	Price
NLN1/4	1/4"		100		5000	
NLN5/16	5/16"		100		4000	
NLN3/8	3/8"		100		2500	
NLN7/16	7/16"		100		2000	
NLN1/2	1/2"		100		1000	
NLN5/8	5/8"		50		550	
NLN3/4	3/4"		50		350	



REVERSIBLE LOCK NUT - ZINC PLATED

Part No.	Size	Each	Box		Carton	
			Qty.	Price	Qty.	Price
LN5/162W	5/16"		100		5000	
LN5/162WWF	5/16"		100		5000	
LN1/42WWF	1/4"		100		5000	
LN3/82W	3/8"		100		4000	
LN7/162W	7/16"		50		2000	
LN1/22W	1/2"		50		1500	
LN5/82W	5/8"		25		700	
LN3/42W	3/4"		20		500	

FLAT WASHER - ZINC PLATED

Part No.	Size	Each	Box		Carton	
			Qty.	Price	Qty.	Price
FW1/4	1/4"		100		7450	
FW5/16	5/16"		100		4350	
FW3/8	3/8"		100		3350	
FW7/16	7/16"		100		2050	
FW1/2	1/2"		100		1300	
FW5/8	5/8"		100		650	
FW3/4	3/4"		100		455	
FW7/8	7/8"		100		325	
FW1	1"		100		265	
FW1-1/2B	1-1/2" Black		50		130	

MACHINE SCREWS - PAN PHILLIPS

Part No.	Size	Box 100
PPMS10-24-3/4	#10-24 x 3/4"	
PPMS8-32-3/4	#8-32 x 3/4"	



TAPPING SCREWS - FLAT PHILLIPS

Part No.	Size	Box 100
00601-012-401	#10 x 3/4"	



MACHINE SCREWS - FLAT PHILLIPS

Part No.	Size	Box 100
FPMS10-24-3/4	#10-24 x 3/4"	
FPMS8-32-3/4	#8-32 x 3/4"	



TAPPING SCREWS - PAN PHILLIPS

Part No.	Size	Box 100
00631-1012-401	#10 x 3/4"	



LOCK WASHER - ZINC PLATED

Part No.	Size	Each	Box		Carton	
			Qty.	Price	Qty.	Price
LW1/4	1/4"		100		22500	
LW5/16	5/16"		100		12500	
LW3/8	3/8"		100		8000	
LW7/16	7/16"		100		5500	
LW1/2	1/2"		100		3750	
LW5/8	5/8"		100		2000	
LW3/4	3/4"		100		1250	



WEDGE ANCHOR - ZINC PLATED

Part No.	Size	Each	Box	
			Qty.	Price
WA1/2X4-1/4	1/2" x 4-1/4"		25	
WA3/4X5-1/2	3/4" x 5-1/2"		20	
WA7/8X6	7/8" x 6"		5	

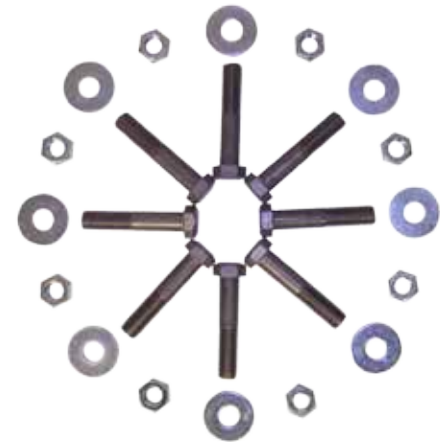

ALL THREAD ROD - ZINC PLATED

Part No.	Size	Each
ATR1/4X3	1/4" x 3'	
ATR5/16X3	5/16" x 3'	
ATR3/8X3	3/8" x 3'	
ATR7/16X3	7/16" x 3'	
ATR1/2X3	1/2" x 3'	
ATR5/8X3	5/8" x 3'	
ATR3/4X3	3/4" x 3'	
ATR7/8X3	7/8" x 3'	
ATR1X3	1" x 3'	



NUT & BOLT SET - ZINC PLATED

Part No.	Size	Each
NBS5/8X2	5/8" x 2"	
NBS5/8X3	5/8" x 3"	
NBS5/8X4	5/8" x 4"	
NBS5/8X5	5/8" x 5"	
NBS5/8X6	5/8" x 6"	
NBS3/4X2	3/4" x 2"	
NBS3/4X3	3/4" x 3"	
NBS3/4X4	3/4" x 4"	
NBS3/4X4.5	3/4" x 4-1/2"	
NBS3/4X5	3/4" x 5"	
NBS3/4X6	3/4" x 6"	
NBS7/8X2	7/8" x 2"	
NBS7/8X3	7/8" x 3"	
NBS7/8X5	7/8" x 5"	
NBS7/8X7.5	7/8" x 7-1/2"	
NBS1X3	1" x 3"	
NBS1X8	1" x 8"	

Other sizes and grades including stainless are available. Please call for availability.

INTRO 1. ELECTRICAL 2. PUMP Acc. 3. HOSE, PE PIPE & Acc. 4. IPS, PIP Pipe & Acc. 5. SURFACE 6. SPRINKLERS 7. TRAVELER & WHEEL MOVE 8. PIVOT 9. TURN 10. LOW VOLUME 11. FILTERS 12. INJECTION 13. HARDWARE INDEX

MIDWEST RAKE

All Digging Tools have Heavy-Duty, High Quality, Stronger Gauge Steel Handles & Attachments.

TRENCH SHOVEL T HANDLE

Description	Part No.	Price
All Steel Landscape Lightning Trencher 8-1/4" Wide and Nearly 10" Long Blade, 45" overall length	49045	



TRENCH SHOVEL

Description	Part No.	Wood Handle	Part No.	Fiberglass Handle	Part No.	Polymer Handle
3" Trench Shovel	89223		89233		89243	
4" Trench Shovel	89224		89234		89244	
5" Trench Shovel	89225		89235		89245	
6" Trench Shovel	89226		89236		89246	



DRAIN SPADE

Description	Part No.	Wood Handle	Part No.	Fiberglass Handle	Part No.	Polymer Handle
14" Drain Spade	49336		49597		49666	
14" Drain Spade D-Handle	49337		-		49667	



SQUARE POINT SHOVEL

Description	Part No.	Wood Handle	Part No.	Fiberglass Handle	Part No.	Polymer Handle
Square Point Shovel	49332				49652	
Square Point Shovel D-Handle	49333		-	-	-	



CAPROCK IRRIGATION SHOVEL

Description	Part No.	Wood Handle	Part No.	Fiberglass Handle	Part No.	Polymer Handle
Caprock Irrigation Shovel	49181		49581		49691	
Caprock Irrigation Shovel D Handle					49692	



ROUND POINT SHOVEL

Description	Part No.	Wood Handle	Part No.	Fiberglass Handle	Part No.	Polymer Handle
Round Point Shovel	49330		49560		49650	



SCOOP SHOVEL

Description	Part No.	Wood Handle	Part No.	Fiberglass Handle	Part No.	Polymer Handle
Scoop Shovel D-Handle	49064		-		-	



POST HOLE DIGGER

Description	Part No.	Wood Handle	Part No.	Fiberglass Handle	Part No.	Polymer Handle
Post Hole Digger	21100		21210		-	



MIDWEST RAKE

RAILROAD PICK

Part No.	Description	Price
85525	5 LB. Railroad Pick - Head Only	
63025	36" Hickory Pick - Handle Only	

SAN ANGELO BAR

Part No.	Description	Price
85367	17 LB. San Angelo Bar 72" x 1" Hex	

SLEDGE HAMMERS

Part No.	Description	Price
41555	4 LB. Sledge Hammer with 16" Wood Handle	
41558	10 LB. Sledge Hammer with 36" Wood Handle	
41511	3 LB. Drilling Hammer with 10" Fiberglass Handle	
41515	4 LB. Sledge Hammer with 16" Fiberglass Handle	
41518	10 LB. Sledge Hammer with 36" Fiberglass Handle	

PROBE

Part No.	Description	Price
85465	4' Fiberglass Probe with Metal Tip	
85462	4' Steel Probe with Metal Tip	

FORGED GARDEN HOE

Part No.	Description	Price
42441	Forged Garden Hoe with 54" Wood Handle	

MORTAR HOE

Part No.	Description	Price
42430	10" Mortar Hoe with 66" Fiberglass Handle	

LEVEL HEAD RAKE

Part No.	Description	Price
42355	14" Level Head Rake with 54" Wood Handle	
42600	14" Forged Bow Rake with 60" Aluminum Handle	

ALUMINUM RAKE

Part No.	Description	Price
12024	24" Aluminum Landscape Rake with 66" Aluminum Handle	
12034	30" Aluminum Landscape Rake with 66" Aluminum Handle	
12036	36" Aluminum Landscape Rake with 66" Aluminum Handle	
12042	42" Aluminum Landscape Rake with 66" Aluminum Handle	

PUSH BROOM

Part No.	Description	Price
82718	18" Heavy Bristle Push Broom with Wood Handle	
82124	24" Medium Bristle Push Broom with Fiberglass Handle	



1. ELECTRICAL
2. PUMP Acc.
3. HOSE, PE Pipe & Acc.
4. IPS, PIP Pipe & Acc.
5. SURFACE
6. SPRINKLERS
7. TRAVELER & WHEEL MOVE
8. PIVOT
9. TURF
10. LOW VOLUME
11. FILTERS
12. INJECTION
13. HARDWARE
INDEX

MIDWEST RAKE

CONCRETE COME-A-LONG

Part No.	Description	Price
73320	20" Steel Blade Concrete Come-A-Long with 60" Alum Handle	

TAMP TOOL

Part No.	Description	Price
85054	3.5" x 12" Tamp with 58" Handle	

EZ OUT TOOL

Part No.	Description	Price
41250	.5" & .75" EZ Out Aluminum Head	

SPRINKLER KEY

Part No.	Description	Price
85480	7" Sprinkler Key	
85482	30" Sprinkler Key	
85485	4' Heavy-Duty Sprinkler & Valve Key	

4 WAY KEY

Part No.	Description	Price
85481	4 Way Key Fits 1/4" - 9/32" - 15/16" - 11/32" Square	

METER KEY

Part No.	Description	Price
85484	28" Meter Key with .5" Opening	
85486	32" Meter Key with 1.125" Opening	

HEAD TRIMMER

Part No.	Description	Price
85422	2" Head Trimmer	
85424	4" Head Trimmer	
85426	6" Head Trimmer	

WHEELBARROW

Part No.	Description	Price
85730	6 Cubic Feet Wheelbarrow	
63202	Dual Wheel Kit for Wheelbarrow	



CHRISTY LANDSCAPE TOOLS

LOAD BUSTER CLEAN UP BAGS

Part No.	Description	Price
TCGB320	3 mil, Black, 20 Bags/Box, 45 Gallon	



LANDSCAPE FABRIC

Part No.	Size	Description	Price
TC.WBSB.20.350	2 oz / 3' x 50'	Charcoal - Fabric Weed Barrier Spunbound	
TC.WBSB.20.6300	2 oz / 6' x 300'	Charcoal - Fabric Weed Barrier Spunbound	
TC.WB.STPBLK	6" X 1" X 6"	Fabric Staple	



GREENLEE® SCREWDRIVER & NUT DRIVER SETS

- Heavy-duty construction for longer life
- High-grade, rust resistant, chrome-plated finish
- Soft, cushioned grip for extra comfort and torque
- Exceeds ASME/ANSI specifications
- Lifetime limited warranty
- Note: This is not an insulated tool

5 PIECE AND 7 PIECE SCREWDRIVER SETS

- Handle marked for easy identification of screwdriver size, type and length
- Precision-machined tips for accurate fastener contact
- Strong, durable black phosphate tips prevents plate chipping and reduces slipping

Part No.	Description	Price
0153-01C	5 Piece Screwdriver Set, Contains 3/16" x 6" Cabinet, 1/4" x 4" Keystone, 1/4" x 6" Cabinet, 5/16" x 6" Keystone & #2 x 4" Phillips	
0153-02C	7 Piece Screwdriver Set, Contains 3/16" x 4" Cabinet, 3/16" x 6" Cabinet, 1/4" x 4" Keystone, 1/4" x 4" Cabinet, 5/16" x 6" Keystone, #1 x 3" Phillips & #2 x 4" Phillips	



7 PIECE NUT DRIVER SET

- Rugged hollow shaft for screw clearance
- Handle marked for easy identification of nut driver size
- Precision heads for accurate fastener fit

Part No.	Description	Price
0253-01C	7 Piece Nut Driver Set, Contains (3" Shank): Sizes 3/16", 1/4", 5/16", 11/32", 3/8", 7/16" & 1/2"	



GREENLEE® INSULATED SCREWDRIVER & NUT DRIVER SETS

- Rated to 1000 V AC/DC
- Meets the IEC 60900 and ASTM F1505 standards
- Heavy-duty construction for longer life
- Lifetime limited warranty
- Ergonomically designed handle for added comfort and torque

9 PIECE INSULATED SCREWDRIVER SET

- Precision-machined tips for accurate fastener contact
- Strong, durable black phosphate plating prevents chipping and reduces slipping

Part No.	Description	Price
0153-01-INS	9 Piece Insulated Screwdriver Set, Contains #1" x 3", #2 x 4", #3 x 6", 1/4" x 4", 3/16" x 4", 3/16" x 6", 3/16" x 8", 5/16" x 6", 3/8" x 10"	



7 PIECE INSULATED NUT DRIVER SET

- Rugged deep well sockets for screw clearance
- Precision heads for accurate fastener fit

Part No.	Description	Price
0253-03NH-INS	7 Piece Insulated Nut Driver Set, Contains Sizes 3/16", 1/4", 5/16", 11/32", 3/8", 7/16" & 1/2"	



GREENLEE® 6-IN-1 MULTI-TOOL

- Versatile multi-bit screwdriver, 6 tools in one
- Precision machined, hardened steel bits
- High-grade, rust resistant, chrome-plated finish
- Soft, cushioned grip for extra comfort and torque
- Lifetime limited warranty
- Note: This is not an insulated tool



Part No.	Description	Price
0153-42C	6 in 1 Multi-Tool Contains, Bit sizes 3/16" & 1/4" Flat-tip, #1 & #2 Phillips and 5/16" & 1/4" Hex	

GREENLEE® 7-PIECE COMBINATION RATCHETING WRENCH SET - STANDARD

- Compact reversible switch allows a 15° offset of the box end for clearance of obstacles
- "Five-degree" ratcheting design for versatility and ease of use in tight spaces
- Polished chrome finish for superior corrosion resistance
- Precision heads for accurate fastener fit
- Hardened for durability and longer life
- Exceeds ASME/ANSI specifications
- Lifetime limited warranty
- Note: This is not an insulated tool



7 PIECE RATCHETING WRENCH SET

Part No.	Description	Price
0354-01	7 Piece Combination Ratcheting Wrench Set, Contains Sizes 1/4", 5/16", 3/8", 7/16", 1/2", 9/16" & 5/8"	

GREENLEE® COMPOSITE HANDLE ADJUSTABLE WRENCH

- Patented lightweight ergonomic design reduces user fatigue
- Precision-machined to tight tolerances for professional feel and smooth operation
- Wide capacity jaw design provides extra versatility
- Measuring scale on head for easy sizing
- Corrosion-resistant finish
- Exceeds ASME/ANSI specifications
- Lifetime limited warranty
- Note: This is not an insulated tool



Part No.	Description	Price
0154-10C	10" Adjustable Wrench Composite Handle	

GREENLEE® DRILL TAP AND HOLE SAW KITS

DRILL TAP KIT

Part No.	Description	Price
DTAPKIT	6-32 to 1/4-20 6 Piece Drill / Tap Set	



HOLE SAW KIT

Part No.	Description	Price
830Q	Quick Change Hole Saw Kit for 1/2" through 2" Conduit	



GREENLEE® LONG NOSE AND DIAGONAL CUTTING PLIERS

- Wider grip design provides larger load bearing area for user comfort
- Forged from chrome vanadium steel for greater durability and strength
- Through-hardened steel for longer life
- Exceeds ASME/ANSI specifications
- Rugged riveted construction for smooth precise action
- Lifetime limited warranty
- Custom grip allows area for user identification
- Flared handles for added comfort and leverage
- Note: This is not an insulated tool

LONG NOSE PLIERS

- Effectively cuts both solid and stranded copper wire
- Diamond-serrated jaws and hardened cutting edges for optimum cutting and gripping performance

Part No.	Description	Price
0351-07M	Long Nose Pliers / Side Cutting 7" Molded Grip	



DIAGONAL CUTTING PLIERS

- Precision-machined and induction-hardened blades strengthen cutters and provide consistent performance
- Effectively cuts most hardened wire, ACSR, bolts, screws and nails
- Dual cutting edges for optimum cutting performance

Part No.	Description	Price
0251-06M	Diagonal Cutting Pliers 6" Molded Grip	



GREENLEE® PUMP PLIERS

- Precision-machined and through-hardened for consistent performance and longer life
- Right-angled teeth for gripping in both directions
- Riveted process ensures joint integrity
- Exceeds ASME/ANSI specifications
- Lifetime limited warranty
- Note: This is not an insulated tool

MOLDED GRIP PUMP PLIERS

- Custom grip allows area for user identification
- Slip-proof, ergonomic molded grip for increased comfort and reduced user fatigue
- Wider grip design provides larger load bearing area

Part No.	Description	Price
0451-10M	Pump Pliers 10" Molded Grip	



DIPPED GRIP PUMP PLIERS

- Double layered vinyl handles for comfort and slip resistance
- Handles allow for easy storage of tools in pouches and tool bags

Part No.	Description	Price
0451-16D	Pump Pliers 16" Dipped Grip	



INTRO
 1. ELECTRICAL
 2. PUMP Acc.
 3. HOSE, PE PIPE & Acc.
 4. IPS, PIP Pipe & Acc.
 5. SURFACE
 6. SPRINKLERS
 7. TRAVELER & WHEEL MOVE
 8. PIVOT
 9. TURN
 10. LOW VOLUME
 11. FILTERS
 12. INJECTION
 13. HARDWARE
 INDEX

GREENLEE® POCKET-LIGHT FLASHLIGHT

- High intensity Xenon fired lamp
- Made of tough ABS polycarbonate
- Luminous tip so flashlight can be located in the dark
- Batteries included
- Lifetime limited warranty
- Submersible to 500'



Part No.	Description	Price
FL2AAAP	Pocket Flashlight	

GREENLEE® KEYHOLE SAW

- Integrated blade and handle design provides maximum strength
- Ergonomic handle with non-slip grip
- Hardened steel blade with clog-free teeth
- Pointed tip easily punches through drywall
- Blade cuts on both push and pull strokes
- Hole in handle may be used for lanyard or convenient storage
- Note: This is not an insulated tool



Part No.	Description	Price
301A	6" Keyhole Saw	

GREENLEE® UTILITY KNIFE

- Over-molded for secure, comfortable grip
- Retractable three-position blade for safety and convenience
- Easy front-loading design provides for quick blade change
- Blade storage in pop-up holder
- Packaged with three heavy-duty patented serrated blades (Cat # 9952-11)
- Note: This is not an insulated tool



Part No.	Description	Price
0652-11	Utility Knife with Blades	

GREENLEE® TOOL BAGS

11" CORDURA OPEN TOOL CARRIER

- Constructed of a double-layer of rugged, lightweight Cordura fabric
- Versatile thirty-seven pocket and loop design keeps tools organized
- Large square opening with snap handle allows for easy access to spacious interior and pockets
- Box-shaped design and sturdy reinforced bottom with rubber feet prevent tipping
- Heavy-duty box stitching with washer riveting at all stress points for extra strength and longer life
- Padded handle, adjustable shoulder strap and additional built-in straps for extra versatility
- Heavy-duty tape measure holder accepts and holds any size tape securely



18" HEAVY-DUTY MULTI-POCKET BAG

- Constructed of heavy-duty nylon for longer life
- Thirty-one multi-use reinforced pockets, inside and out help organize tools and accessories
- Large-opening steel-framed mouth with hinge and zipper for rugged use and easy access to contents
- Padded handles and adjustable shoulder strap for comfort and versatility
- Large interior to easily carry power tools, fish tapes and other large tools
- Wrap around handles with reinforced stitching fully support bag bottom for heavy load capacity
- Elastic straps on outside of bag for levels, hammers and crowbars



Part No.	Description	Price
0158-13	11" Cordura Open Tool Carrier	
0158-12	18" Heavy-Duty Multi-pocket Bag	

ECONOMY HAND TOOLS



KNIVES

Part No.	Item	Description	Price
760012D	1	Stainless Steel SWIK 32D Knife	
UK12D	2	Utility Knife	
71034	3	Dual Blade Pocket Knife	
75101	4	2-1/2" Bone Handle Knife - 2 Blades	
75102	5	3" Bone Handle Knife - 2 Blades	
75103	6	3" Bone Handle Knife - Brass Bolster	
75104	7	3-1/2" Bone Handle Knife - Brass Bolster	
75105	8	4" Bone Handle Knife - 2 Blades	
75106	9	4-1/2" Bone Handle Knife - Brass Bolster	
75107	10	3-1/2" Bone Handle Knife - 3 Blades	
75108	11	4" Bone Handle Knife - 2 Blades	
75201	12	3" Stainless - Wood Inlay & Belt Clip	
75202	13	3-1/2" Stainless - Wood Inlay	
75203	14	4" Stainless - Wood Inlay	
75204	15	4" Stainless - Wood Inlay & Belt Clip	
75205	16	4-1/2" Stainless - Wood Inlay & Belt Clip	
75206	17	5" Stainless - Wood Inlay	
75207	18	3-1/2" Stainless - Wood Inlay - 2 Blade	
75208	19	4" Stainless - Wood Inlay - 3 Blade	

INTRO
 1. ELECTRICAL
 2. PUMP ACC.
 3. HOSE, PE PIPE & ACC.
 4. IPS, PIP PIPE & ACC.
 5. SURFACE
 6. SPRINKLERS
 7. TRAVELER & WHEEL MOVE
 8. PIVOT
 9. TURF
 10. LOW VOLUME
 11. FILTERS
 12. INJECTION
 13. HARDWARE
 INDEX

ECONOMY HAND TOOLS

HAMMERS

Part No.	Description	Price
BPH-16	Ball Peen Hammer	
19405	Rubber Mallet	
FCH-16	Claw Hammer	
WSH-212	2 LB. Sledge Hammer	



BAR TOOLS

Part No.	Description	Price
UB-15	15" Utility Bar	
WB-18	18" x 5/8" Wrecking Bar	



WIRE BRUSH

Part No.	Description	Price
WB-240	Wire Brush	



TAPE MEASURE

Part No.	Description	Price
63700	25' x 1-1/4" Easy Read Tape Measure	
FLT-25	25' x 1" Tape Measure	
KTM6611	100' Surveyors Tape	
MW11-0765	3' Measuring Wheel Curved Handle	



SCREWDRIVER SET

Part No.	Description	Price
BHSD-2	2 Piece Big Handle Screwdriver Set	



PLIERS & WRENCHES

Part No.	Description	Price
SJ-8	8" Slipjoint Pliers	
BNP-6	6" Bent Nose Pliers	
LNLG-7	7" Long Nose Pliers	
LG-10	10" Locking Pliers	
GJ-10	10" Groove Joint Pliers	
EN-6	6" End Nipper Pliers	
LP-8	8" Linesman Pliers	
AW-8	8" Adjustable Wrench Set	



XCAD AQUA BURST NOZZLE MULTI-TOOL

Part No.	Description	Price
NOZTOOL	Nozzle Tool for 3/4" Sprinkler	
NOZTOOL.5	Nozzle Tool for 1/2" Sprinkler	

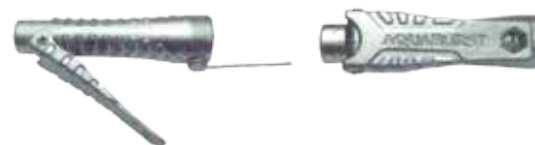

Nozzle Tool Features:

- All stainless steel construction
- EZ grip handles
- Stainless steel nozzle plug wire
- NOZTOOL fits nozzles with 3/8", 7/16", 1/2", and 3/4" hex heads
- NOZTOOL.5 fits nozzles with 3/8" and 7/16" hex heads



GLOVES

Part No.	Size	Description	Price
TC-1956L	L	Tiger Paw	
8550	M-XL	Grain Goatskin Thinsulate Lined, Keystone Thumb	
3451	M-XL	Pigskin Driver, Fleece Lined	
8825	M-XL	Pigskin Grain, Keystone Thumb, Unlined	
107	M-XL	Latex Dipped String Knit Cotton / Polyester	
K422	M-XL	Cowhide Grain Palm, Shoulder Split Back	
K2260	M-XL	Cowhide Grain, Keystone Thumb	
90	L	Brown Jersey with Knitwrist	

RATCHET TIE DOWNS

Part No.	Description	Price
RCL-220	2" x 20' Ratchet Tie Down	
RTD-15	1" x 15' Ratchet Tie Down	
HH-557-30	2" x 30' Ratchet Tie Down	



BUNGIE TIE DOWNS

Part No.	Description	Price
496-90	9" Bungie Tie Down	
496-150	15" Bungie Tie Down	
496-200	20" Bungie Tie Down	
496-300	30" Bungie Tie Down	



INTRO
 1. ELECTRICAL
 2. PUMP ACC.
 3. HOSE, PE PIPE & ACC.
 4. IPS, PIP PIPE & ACC.
 5. SURFACE
 6. SPRINKLERS
 7. TRAVELER & WHEEL MOVE
 8. PIVOT
 9. TURF
 10. LOW VOLUME
 11. FILTERS
 12. INJECTION
 13. HARDWARE
 INDEX

BECKSON UTILITY HAND PUMP

This manual pump easily removes water from valve boxes, trenches or on maintenance jobs, eliminating the need for you to be on your hands and knees, scooping water. It is compact and durable, made of high impact PVC. It is light weight, will not rust and is self priming. For non-potable water only.

Part No.	Description	Price
136PF-6	1-3/4" Dia. x 36" Hand Suction Pump with 35 oz. Stroke and 1-1/4" x 72" Hose	



SIPHON KING UTILITY PUMP

Part No.	Description	Price
KWC-48072	36" Pump x 72" Hose	



JOHN DEERE™ GUZZLER HAND SUCTION PUMP

Part No.	Description	Price
DN100G	2" Dia. x 9" Hand Suction Pump for Small Cavity Water Removal	



SP SYSTEMS® SPRAYERS

Part No.	Description	Price
FH20	2 Gallon Farm & Home Sprayer - Viton Seal	
SYT189	4 Gallon Backpack Sprayer - Viton Seal	
5301378	25 Gallon Spot Sprayer	



TRANSFER PUMPS

- Air Cooled 4-stroke OHV with Transistorized Ignition, Recoil Start and Cast Iron Cylinder Sleeve
- Pressure Cast Aluminum Pump Body
- High Quality, Mechanically Sealed Equipment
- NPT Inlet / Outlet Threading



TRANSFER PUMP

Part No.	Horse Power	Price
TP2	6.5	
TP3	6.5	
TP4	9.0	
LTF2	6.5	

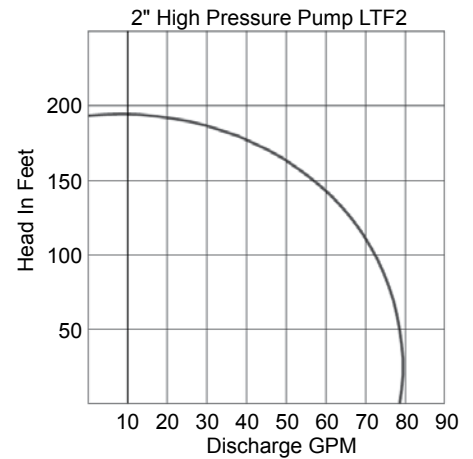

2", 3" AND 4" TRANSFER PUMP CHART

Model		TP2	TP3	TP4
Pump	Suction	2"	3"	4"
	Discharge	2"	3"	4"
	Cont. Capacity GPM	96	158	171
	Max. Capacity GPM	158	270	290
	Max. Head (Ft.)	91	82	131
	Cont. Head (Ft.)	49	42	68
	Max Suction Head (Ft.)	26	26	26
Engine	Type	Air-Cooled 4 Stroke OHV		
	Output (HP)	5.5	5.5	8
	Fuel Capacity (Gal)	.9	.9	1.5
	Net Weight LBS	55	66	103

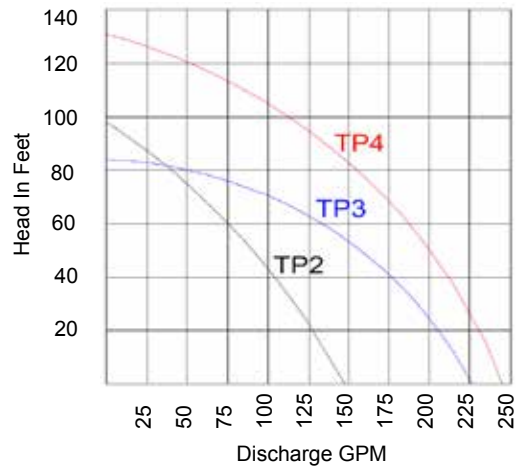

BANJO POLY PUMPS

6.5 HP Pro Engine Features

- Cast Iron Cylinder Sleeve
- Heavy Duty Flywheel
- Overhead Valve
- High Oil Fill
- Oil Guard® Low Oil Sensor
- Breath Through Air Cleaner



Pump Features

- Precision molded construction
- Lightweight • Corrosion resistant
- Superior design • Low maintenance.
- EPDM Standard, FKM (viton type) available

GAS ENGINE PUMP WITH EPDM RUBBER PARTS (POLY)

Part No.	Description	Price
200P6PRO	Complete Pump & 6.5 HP Briggs & Stratton Pro Series Gas Engine	

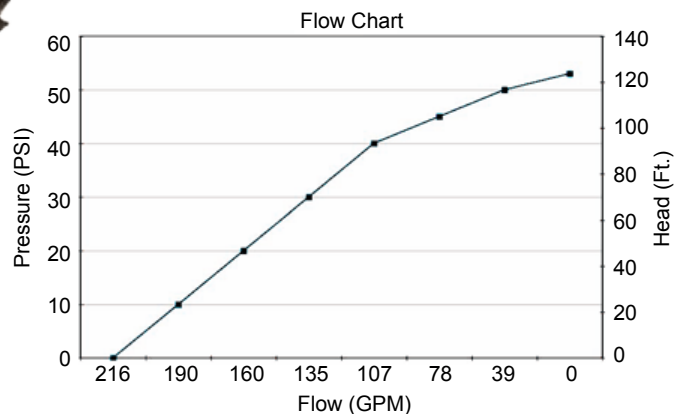

MARKING FLAGS, TAPE, PAINT AND ACCESSORIES

MARKING FLAGS

Whether your use is for staking pipelines, wire, valves, sprinkler locations, pivot points or any other use, you're sure to be satisfied with the quality of these marking flags. Made from durable 4 mil plastic sheeting, they will stand up to sun, wind and inclement weather. The plastic flags will stay on the staffs and the colors won't fade. Flags are 4" x 5" and attached to a sturdy 15.5 gauge 21" steel wire staff. Sold only in bundles of 100 flags. Standard colors are listed below, however additional colors are available by special order.

Part No.	Color	Size	100-900	1000+
FLAG-RED-1C	Red	Flag 4" x 5" Staff 21"	Per Bundle of 100 Flags	Per Bundle of 100 Flags
FLAG-WHT-1C	White			
FLAG-YEL-1C	Yellow			
FLAG-ORG-1C	Orange			
FLAG-BLU-1C	Blue			
FLAG-GRN-1C	Green			
FLAG-SIL-1C	Silver			
FLAG-PPL-1C	Purple			
FLAG-FLP-1C	Flr. Pink			
FLAG-FLO-1C	Flr. Orange			



Note: Additional flag sizes, staff lengths & custom flags available upon request.

MARKING TAPE

Made from fade resistant color saturated 2.5 mil PVC, this fluorescent orange tape is a bold and vibrant color, making it easy to see. Additional colors available are white and blue.

Part No.	Description	Price
TFOG	1-3/16" x 300' Roll, Fluorescent Orange	
TFW	1-3/16" x 300' Roll, Fluorescent White	
TFB	1-3/16" x 300' Roll, Fluorescent Blue	



PRINTED MARKING TAPE

Custom and Standard prints are available to fit your needs. Many additional colors available upon request.

Part No.	Description	Price
CU-BLK-XX	1-1/2" x 300' Roll, Black	
CU-BLU-XX	1-1/2" x 300' Roll, Blue	
CU-GRN-XX	1-1/2" x 300' Roll, Green	
CU-RED-XX	1-1/2" x 300' Roll, Red	



DAY NIGHT VISIBILITY FLAGGING

Part No.	Description	Price
SOGREF	1-3/16" x 150' Roll, Orange Glow	



MARKING PAINT & MARKING TOOLS

This economical paint is lead free and APWA approved.

Part No.	Description	Price
S03610	Fluorescent RED Marking Paint	
S03612	Fluorescent PINK Marking Paint	
S03700	Fluorescent ORANGE Paint	
S03722	Fluorescent BLUE Marking Paint	
S03801	Fluorescent YELLOW Marking Paint	
S03901	Fluorescent WHITE Marking Paint	
MW34	34" Marking Paint Wand	



COLD GALVANIZE COATING SPRAY

Part No.	Description	Price
SPO-740	7007 Cold Galvanize Coating 93% Zinc Rich	



BARRICADE TAPE

Part No.	Description	Price
B332XX	2 Mil. 3" x 300' Polyethylene	
B3102XX	2 Mil. 3" x 1000' Polyethylene	
B3322XX	2.5 Mil. 3" x 300' Polyethylene	
B31022XX	2.5 Mil. 3" x 1000' Polyethylene	
B333XX	3 Mil. 3" x 300' Polyethylene	
B3103XX	3 Mil. 3" x 1000' Polyethylene	

XX = Color and wording

Colors Available: Black, Blue, Green, Orange, Red, White, Yellow, Yellow/Black Striped.

Prints Include: Caution, Caution Do Not Enter, Danger, Danger Do Not Enter, and many others.

Materials Available: Biodegradable Cellulosic and Woven Polypropylene.

Easy to tear off markers & pennant flags also available.



ADHESIVE MARKING TAPE

Part No.	Color	Description	Price
A2SWBK18	White / Black	Hazard Warning Tape 6 Mil. 2" 18 Yards	
A2SWBK36	White / Black	Hazard Warning Tape 6 Mil. 2" 36 Yards	
A2SWR18	White / Red	Hazard Warning Tape 6 Mil. 2" 18 Yards	
A2SWR36	White / Red	Hazard Warning Tape 6 Mil. 2" 36 Yards	
A2SYBK18	Black / Yellow	Hazard Warning Tape 6 Mil. 2" 18 Yards	
A2SYBK36	Black / Yellow	Hazard Warning Tape 6 Mil. 2" 36 Yards	



AISLE MARKING TAPE

Part No.	Color	Description	Price
A2BK36	Black	Aisle Marking Tape Solid 6 Mil. 2" 36 Yards	
A2B36	Blue	Aisle Marking Tape Solid 6 Mil. 2" 36 Yards	
A2G36	Green	Aisle Marking Tape Solid 6 Mil. 2" 36 Yards	
A2R36	Red	Aisle Marking Tape Solid 6 Mil. 2" 36 Yards	
A2W36	White	Aisle Marking Tape Solid 6 Mil. 2" 36 Yards	
A2Y36	Yellow	Aisle Marking Tape Solid 6 Mil. 2" 36 Yards	

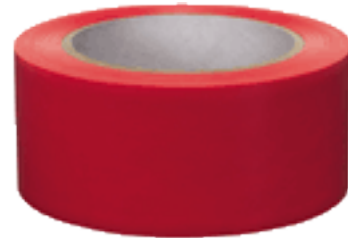

DETECTABLE UNDERGROUND WARNING TAPE

For accurately locating & preventing damage to underground utility installations with aluminum backing to make underground assets easy to find using a non-ferrous locator. Standard prints are available.

Part No.	Description	Price
D2105XX	5 Mil. 2" x 1000'	
D3105XX	5 Mil. 3" x 1000'	
D6105XX	5 Mil. 6" x 1000'	

XX = Color and wording



NON DETECTABLE UNDERGROUND WARNING TAPE

Part No.	Description	Price
B3104XX	4 Mil. 3" x 1000'	
B6104XX	4 Mil. 6" x 1000'	

XX = Color and wording

Available in Blue, Green, Orange, Purple, Red, Yellow and Black. Made of highly visible polyethylene material. Custom print and numerous standard legends are available.



INTRO
1. ELECTRICAL
2. PUMP Acc.
3. HOSE, PE PIPE & Acc.
4. IPS, PIP PIPE & Acc.
5. SURFACE
6. SPRINKLERS
7. TRAVELER & WHEEL MOVE
8. PIVOT
9. TURF
10. LOW VOLUME
11. FILTERS
12. INJECTION
13. HARDWARE
INDEX

5/64 0.078

SECTION 14

Formulas & Index

CONTENTS

- 14:3 PIVOT IRRIGATION NOTES
- 14:4 ORDER FORM
- 14:5 PIVOT DATA FORM
- 14:6 HOSE & CLAMP SELECTION GUIDE
- 14:6 LAYFLAT HOSE & CLAMPS
- 14:6 DISCHARGE HOSE & CLAMPS
- 14:7 HOSE & CLAMP SELECTION GUIDE
- 14:7 DISCHARGE HOSE & CLAMPS CONTINUED
- 14:7 SUCTION HOSE & CLAMPS
- 14:8 FUSE SELCTION CHART
- 14:9 COMMON ABBREVIATIONS
- 14:10-13 TECHNICAL RESOURCES
- 14:14-17 FRICTION LOSS CHARACTERISTICS
- 14:18-31 INDEX

9/64 0.141

5/32 0.156

1/64 0.172

3/16 0.188

9/64 0.768

5/32 0.784

1/64 0.790

3/16 0.806

3/64 0.822

7/32 0.848

5/64 0.854

7/8 0.870

7/64 0.896

9/32 0.902

9/64 0.928

5/16 0.934

1/64 0.950

1/32 0.966

1/64 0.982

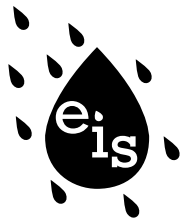

Wish INC.



Wish NEBRASKA, INC.

SWISH
INC.

Wish NORTHWEST, INC.

PIVOT DATA FORM

Quote #: _____ Order #: _____

EIS	ESCO	SWISH	WISH-CO	WISH-NE	WISH-NW
Fax: (352) 472-2830	(806) 747-2706	(254) 968-4075	(303) 364-5055	(866) 549-2183	(208) 232-0694

► Dealer Info:

Person Placing Order: _____
 Sold To: _____

PO#: _____ Date: ____/____/____
 Ship to: _____

► Existing System Specifications

Pivot Manufacturer: _____
 Model: _____ Year: _____
 Serial #: _____ Linear: ____ Cornerarm: ____

Irrigator's Name: _____
 System # or Legal: _____
 Inside Pipe Coating: _____

► Retro Fit Design:

Max Field Elevation: Above _____ Below _____
 Regulators: Manufacturer: _____ Model: _____
 Nominal Pressure Rating (psi): _____
 Drops: Length or Ground Clearance (ft): _____
 Drop Pipe Nominal Diameter (in): _____
 Drop Pipe Material: _____
 Weights: _____

Endgun Model: _____
 _____ Endgun Valve _____ Booster Pump (HP)
 _____ Booster at tower with _____ diameter pipe
 Timer at 100% last tower travels ____ ft. /min.
 Motor HP: ____ RPM: ____ Center Ratio RPM: ____
 Tire Size: _____ Wheel gear box ratio: ____

► Sprinkler Package ► Sprays:

- | | |
|---------------------------------|---|
| _____ Nelson D3000 Spray | <input type="checkbox"/> Concave |
| _____ Nelson T3000 Trashbuster | <input type="checkbox"/> Flat |
| _____ Senninger LDN Sprays | <input type="checkbox"/> Convex |
| _____ Senninger Super Sprays | <input type="checkbox"/> Chemigation |
| _____ Senninger LEPA | <input type="checkbox"/> Smooth |
| _____ Nelson D3000 Part Circle | <input type="checkbox"/> Medium Groove |
| _____ Senninger LDN Part Circle | <input type="checkbox"/> Deep Groove |
| _____ Senninger Fan Spray | <input type="checkbox"/> Multi-trajectory |
| _____ Hose Drag | <input type="checkbox"/> UP3 |
| _____ Other Plate Color: _____ | <input type="checkbox"/> Multi-Pads |

► Other Heads:

- | | | | |
|---------------------------------|---|---|------------------------------------|
| _____ Nelson R3000 Rotators | <input type="checkbox"/> U4 Blue | <input type="checkbox"/> U6 White | <input type="checkbox"/> D4 Green |
| | <input type="checkbox"/> D6 Red | <input type="checkbox"/> D8 Orange | <input type="checkbox"/> D10 Brown |
| _____ Nelson TR3000 Trashbuster | <input type="checkbox"/> U4 Blue | <input type="checkbox"/> D4 Green | |
| _____ Nelson PC R3000 Rotators | <input type="checkbox"/> HF Black | <input type="checkbox"/> MF Tan | <input type="checkbox"/> LF White |
| _____ Nelson S3000 Spinners | <input type="checkbox"/> D6 Red | <input type="checkbox"/> D6 Purple | <input type="checkbox"/> D8 Yellow |
| _____ Nelson A3000 Accelerators | <input type="checkbox"/> U6 Navy | <input type="checkbox"/> D4 Maroon | <input type="checkbox"/> D6 Gold |
| _____ Nelson O3000 | <input type="checkbox"/> Blue | <input type="checkbox"/> Black | |
| _____ Nelson N3000 Nutators | <input type="checkbox"/> High Angle Green | <input type="checkbox"/> Low Angle Blue | |
| _____ UP3 Senninger I-Wobs | <input type="checkbox"/> Std Angle Black | <input type="checkbox"/> Low Angle Blue | |
| _____ UP3 Senninger XI-Wobs | <input type="checkbox"/> 610 Blue | <input type="checkbox"/> 605 White | <input type="checkbox"/> 615 Black |
| | | | <input type="checkbox"/> 910 Gray |

► Special Instructions: _____

_____ GPM, _____ PSI at top or end or base of pivot

Span	Length	Pipe O.D.	Sprinkler Spacing	Outlets per Span
1				
2				
3				
4				
5				
6				
7				
8				
9				
10				
11				
12				
C				
OH				
Total Length			Total # of Outlets	

► Impacts:

- | | | |
|---|--|--|
| _____ RB Standard Brass | <input type="checkbox"/> CDS nozzle | <input type="checkbox"/> Straight Bore |
| _____ RB L36H 10 ⁰ (plastic) | | |
| _____ RB LAPS 10 ⁰ | | |
| _____ Senninger 6 ⁰ (plastic) | <input type="checkbox"/> Straight Vane | <input type="checkbox"/> Spiral Vane |
| _____ Senninger 12 ⁰ (plastic) | | <input type="checkbox"/> Blue Cylinder |
| _____ Senninger 25 ⁰ (plastic) | | |
| _____ Nelson F44AAB 8 ⁰ (plastic) | | <input type="checkbox"/> Diffuser Nozzle |
| _____ Nelson 15 ⁰ (brass) | <input type="checkbox"/> Flow Control | <input type="checkbox"/> Taper Bore |
| _____ Nelson <input type="checkbox"/> 75 or <input type="checkbox"/> 100 (wastewater) | | |

► Ship:

- Print Out Sprinklers Regulators Endgun
 Endgun Valve Endgun Nozzle Nozzles Only
 Goosenecks Plugs Drops Weights
 Bushings Couplings Nipples Gauge Clamps
 Booster Pump Other _____

► Ship Via:

- UPS Regular UPS 2nd Day Air UPS Next Day Air
 UPS Next Day Air Letter Fax Mail Priority Mail
 Express Mail Truck Line Pick Up Email

NITRO
 1. ELECTRICAL
 2. PUMP ACC.
 3. HOSE, PE PIPE & ACC.
 4. IPS, PIP PIPE & ACC.
 5. SURFACE
 6. SPRINKLERS
 7. TRAVELER & WHEEL MOVE
 8. PIVOT
 9. TURF
 10. LOW VOLUME
 11. FILTERS
 12. INJECTION
 13. HARDWARE
 INDEX

HOSE & CLAMP SELECTION GUIDE

Unless you know from experience, it's difficult to know which clamp and size works best for your needs. While experience is the best teacher, the tables provided below have been developed from comparing manufactures data which relate to hose OD and clamp ranges. We encourage you to review this information for yourself, found in section 3. Please keep in mind, that while there is only one clamp part number indicated per hose part number and size, there are in fact several different types of clamps and sizes to select from that might work well for your application. Please let us know if you have any questions and if we can assist you in selecting the right clamp for your needs.

LAYFLAT HOSE & CLAMPS

NU-FLO™

Hose Part No.	Size	Clamp Part No.
BLUENF075X300	3/4"	H1000C
BLUENF100X300	1"	H1200C
BLUENF125X300	1-1/4"	94100-0150
BLUENF150X300	1-1/2"	94100-0162
BLUENF200X300	2"	94100-0225
BLUENF250X300	2-1/2"	94100-0275
BLUENF300X300	3"	94100-0325
BLUENF400X300	4"	95130-0425
BLUENF500X300	5"	95130-0525
BLUENF600X300	6"	95130-0625
BLUENF800X300	8"	95130-0825

VINYLFLOW™

Hose Part No.	Size	Clamp Part No.
VF150X300	1-1/2"	94100-0162
VF200X300	2"	94100-0225
VF250X300	2-1/2"	94100-0275
VF300X300	3"	94100-0325
VF400X300	4"	95130-0425
VF500X300	5"	95130-0525
VF600X300	6"	95130-0625
VF800X300	8"	95130-0825
VF1000X300	10"	95130-1044
VF1200X300	12"	HSS224
VF1400X300	14"	HSS224
VF1600X300	16"	STBC1665L

IRONSIDES™

Hose Part No.	Size	Clamp Part No.
IS150X300	1-1/2"	94100-0175
IS200X300	2"	94100-0225
IS250X300	2-1/2"	94100-0275
IS300X300	3"	94100-0325
IS400X300	4"	95130-0425
IS600X300	6"	95130-0625
IS800X300	8"	95130-0825

SPIRAFLEX® BLUE

Hose Part No.	Size	Clamp Part No.
53756404803000	1-1/2"	94100-0175
53756406403000	2"	94100-0225
53756408003000	2-1/2"	94100-0275
53756410703000	3"	94100-0325
53756412303000	4"	95130-0425
53756415503000	6"	95130-0625
53756418703000	8"	95130-0825

SPIRAFLEX® RED

Hose Part No.	Size	Clamp Part No.
53752104803000	1-1/2"	94100-0175
53752106403000	2"	94100-0225
53752108003000	2-1/2"	94100-0275
53752110703000	3"	94100-0325
53752112303000	4"	95130-0450
53752115503000	6"	95130-0644

SF-50 BRICK RED

Hose Part No.	Size	Clamp Part No.
SF-50-400X300	4"	95130-0425
SF-50-600X300	6"	95130-0625
SF-50-800X300	8"	95130-0825

DISCHARGE HOSE & CLAMPS

KLEARON™

Hose Part No.	Size	Clamp Part No.
K010-0305	3/16"	MAH4
K010-0406	1/4"	MAH4
K010-0609	3/8"	H600C
K010-0811	1/2"	H600C
K010-1216	3/4"	H1000C
K010-1620	1"	H1600C

CLEARBRAID®

Hose Part No.	Size	Clamp Part No.
K3150-08	1/2"	H800C
K3150-12	3/4"	H1200C
K3150-16	1"	H1600C

KURI TEC® GENERAL PURPOSE

Hose Part No.	Size	Clamp Part No.
K1154-04	1/4"	MAH4
K1154-16	1"	H1600C

EVA TRANSLUCENT

Hose Part No.	Size	Clamp Part No.
K4350-06	3/8"	H600C
K4350-08	1/2"	H800C
K4350-12	3/4"	H1000C
K4350-16	1"	H1600C

POLYAIR® MULTI-PURPOSE

Hose Part No.	Size	Clamp Part No.
K1134-08	1/2"	H800C
K1134-10	5/8"	H1000C
K1134-12	3/4"	H1200C
K1134-16	1"	H1600C

HORIZON®

Hose Part No.	Size	Clamp Part No.
56900912700200	1/2"	H800C
56900919100200	3/4"	H1200C
56901225400200	1"	H1600C
56901131800200	1-1/4"	94100-0175
56901138100200	1-1/2"	94100-0200
53604006400300	2"	94100-0250

GORILLA®

Hose Part No.	Size	Clamp Part No.
56903512700200	1/2"	H1000C
56903519100200	3/4"	H1200C
56903525400200	1"	H2000C
56903531800200	1-1/4"	94100-0175
56903538100200	1-1/2"	94100-0200
53644606410000	2"	94100-0275

PLICORD® VERSIFLO™ 125 PSI

Hose Part No.	Size	Clamp Part No.
54252710701000	3"	94100-0325
54252712301000	4"	95130-0425
54252715501000	6"	95130-0625

DISCHARGE HOSE & CLAMPS CONTINUED

ALFAGOMMA® T253AA 150 PSI

Hose Part No.	Size	Clamp Part No.
T253AA150X100	1-1/2"	94100-0175
T253AA200X100	2"	94100-0238
T253AA250X100	2-1/2"	94100-0275
T253AA300X100	3"	94100-0350
T253AA400X100	4"	95130-0425
T253AA600X100	6"	95130-0625
T253AA662X100	6-5/8"	95130-0706
T253AA800X100	8"	95130-0844
T253AA1000X100	10"	95130-1044
T253AA1200X50	12"	DB1275

NOVAFLEX 2150

Hose Part No.	Size	Clamp Part No.
2150BE-01250-00	1-1/4"	94100-0150
2150BE-01500-00	1-1/2"	94100-0175
2150BE-02000-00	2"	94100-0225
2150BE-00250-00	2-1/2"	94100-0275
2150BE-03000-00	3"	94100-0325
2150BE-03500-00	3-1/2"	94100-0375
2150BE-04000-00	4"	95130-0425
2150BE-05000-00	5"	95130-0525
2150BE-06000-00	6"	95130-0625
2150BE-06250-00	6-5/8"	95130-0706
2150BE-08000-00	8"	95130-0844
2150BE-08625-00	8-5/8"	95130-0918
2150BE-10000-00	10"	95130-1044
2150BE-10750-00	10-3/4"	DB1125
2150BE-12000-00	12"	DB1275
2150BE-12750-00	12-3/4"	DB1360

PLICORD - PARKER / GOOD YEAR

Hose Part No.	Size	Clamp Part No.
54243712301000	4"	95130-0450
54243713101000	4-1/2"	95130-0500
54243713901000	5"	95130-0550
549806155320	6"	95130-0644
54143716505400	6-5/8"	95130-0725
541806187320	8"	95130-0856
54143719805400	8-5/8"	95130-0918
541806219340	10"	95130-1062
54143725105400	12"	DB1275

SUCTION HOSE & CLAMPS

SPIRAFLEX® 1500

Hose Part No.	Size	Clamp Part No.
58641202401000	3/4"	H1000C
58641203201000	1"	H1600C
58641204001000	1-1/4"	94100-0162
58641204801000	1-1/2"	SDBC-1.5
58641206401000	2"	SDBC-2
58641208001000	2-1/2"	SDBC-2.5
58641210701000	3"	SDBC-3
58641212301000	4"	SDBC-4
58641215501000	6"	SDBC-6
58641218700600	8"	SDBC-8

TIGERFLEX BW "BLUE WATER"

Hose Part No.	Size	Clamp Part No.
BW075X100	3/4"	H1000C
BW100X100	1"	H1600C
BW125X100	1-1/4"	94100-0162
BW150X100	1-1/2"	SDBC-1.5
BW200X100	2"	SDBC-2
BW250X100	2-1/2"	SDBC-2.5
BW300X100	3"	SDBC-3
BW400X100	4"	SDBC-4
BW500X100	5"	SDBC-5
BW600X100	6"	SDBC-6

TIGERFLEX TG "TIGER GREEN"

Hose Part No.	Size	Clamp Part No.
TG200X100	2"	SDBC-2
TG300X100	3"	SDBC-3
TG400X100	4"	SDBC-4
TG600X100	6"	SDBC-6

PLICORD® "CON-AG"

Hose Part No.	Size	Clamp Part No.
54215904001000	1-1/4"	94100-0175
54215904801000	1-1/2"	SDBC-1.5
54215906401000	2"	SDBC-2
54215908001000	2-1/2"	SDBC-2.5
54215910701000	3"	SDBC-3
54215912301000	4"	SDBC-4
54215915501000	6"	SDBC-6

ALFAGOMMA® T202AA/T203AA/T204AA

Hose Part No.	Size	Clamp Part No.
T202AA200X100	2"	SDBC-2
T202AA300X100	3"	SDBC-3
T202AA400X100	4"	SDBC-4
T204AA600X25	6"	SDBC-6
T204AA800X25	8"	SDBC-8
T203AA1000X20	10"	SDBC-10
T203AA1200X20	12"	SDBC-12

NUTRIFLO® FOOD TRANSFER

Hose Part No.	Size	Clamp Part No.
58642104801000	1-1/2"	SDBC-1.5
58642106401000	2"	SDBC-2
58642110701000	3"	SDBC-3
58642112301000	4"	SDBC-4

ALFAGOMMA® BLACK PETROLEUM

Hose Part No.	Size	Clamp Part No.
T605AA200X100	2"	SDBC-2
T605AA300X100	3"	SDBC-3

1. ELECTRICAL 2. PUMP Acc. 3. HOSE, PE PIPE & Acc. 4. IPS, PIP Pipe & Acc. 5. SURFACE 6. SPRINKLERS 7. TRAVELER & WHEEL MOVE 8. PIVOT 9. TURF 10. LOW VOLUME 11. FILTERS 12. INJECTION 13. HARDWARE INDEX

FUSE SELECTION CHART

Note: These charts are made available to be used only as a guide. Always consult your pump and motor manufacturer to be certain that you are using the correct size fuses that meet your particular needs.

FUSE SELECTION CHART FOR THREE PHASE 460V SUBMERSIBLE MOTORS

HORSE POWER	DIAMETER	FLA	SFA	PANEL SIZE	SIEMENS PANEL	O/L RANGE	FUSE SIZE
1	4"	2.0A	2.4A	1	87DUD6FC	5.5-22A	FLSR3ID
1.5	4"	2.5A	3.1A	1	87DUD6FC	5.5-22A	FLSR4ID
2	4"	3.4A	4.1A	1	87DUD6FC	5.5-22A	FLSR5ID
3	4"	4.8A	5.5A	1	87DUD6FC	5.5-22A	FLSR6ID
5	4" & 6"	7.5A	8.9A	1	87DUD6FC	5.5-22A	FLSR10ID
7.5	4" & 6"	10.9A	13.2A	1	87DUD6FC	5.5-22A	FLSR15ID
10	4"	15.9A	17.3A	1	87DUD6FC	5.5-22A	FLSR20ID
10	6"	14.2A	16.1A	1	87DUD6FC	5.5-22A	FLSR20ID
15	6"	20.8A	23.7A	1.75	87EUE6FC	10-40A	FLSR30ID
20	6"	33.0A	37.3A	2	87FUF6FC	13-52A	FLSR35ID
25	6"	33.5A	37.5A	2	87FUF6FC	13-52A	FLSR45ID
30	6"	39.5A	45.2A	2.5	87GUG6FC	25-100A	FLSR60ID
40	6"	54.9A	61.6A	3	87HUG6FC	25-100A	FLSR70ID
40	8"	53.0A	60.0A	3	87HUG6FC	25-100A	FLSR70ID
50	6"	67.7A	77.0A	3	87HUG6FC	25-100A	FLSR90ID
50	8"	64.0A	73.0A	3	87HUG6FC	25-100A	FLSR80ID
60	6"	80.5A	91.0A	3.5	87IUH6FC	50-200A	FLSR100ID
60	8"	76.0A	86.0A	3.5	87IUH6FC	50-200A	FLSR100ID
75	8"	94.0A	107.0A	3.5	87IUH6FC	50-200A	FLSR125ID
100	8"	126.0A	142.0A	4	87JUH6FC	50-200A	FLSR175ID
125	8"	167.0A	188.0A	5	87LPU6FC	100-300A	FLSR225ID
150	8"	194.0A	219.0A	5	87LPU6FC	100-300A	FLSR250ID
175	8"	219.0A	249.0A	5	87LPU6FC	100-300A	FLSR300ID
200	8"	246.0A	282.0A	5	87LPU6FC	100-300A	FLSR350ID

FUSE SELECTION CHART FOR THREE PHASE 460V ABOVE GROUND MOTORS

HORSE POWER	FLA	PANEL SIZE	SIEMENS PANEL	O/L RANGE	FUSE SIZE
1	2.1A	1	87DUD6FC	5.5-22A	FLSR3ID
1.5	3.0A	1	87DUD6FC	5.5-22A	FLSR5ID
2	3.4A	1	87DUD6FC	5.5-22A	FLSR5ID
3	4.8A	1	87DUD6FC	5.5-22A	FLSR6ID
5	7.6A	1	87DUD6FC	5.5-22A	FLSR10ID
7.5	11.0A	1	87DUD6FC	5.5-22A	FLSR15ID
10	14.0A	1	87DUD6FC	5.5-22A	FLSR20ID
15	21.0A	1.75	87EUE6FC	10-40A	FLSR30ID
20	27.0A	2	87FUF6FC	13-52A	FLSR35ID
25	34.0A	2	87FUF6FC	13-52A	FLSR50ID
30	40.0A	2.5	87GUG6FC	25-100A	FLSR60ID
40	52.0A	3	87HUG6FC	25-100A	FLSR70ID
50	65.0A	3	87HUG6FC	25-100A	FLSR90ID
60	77.0A	3.5	87IUH6FC	50-200A	FLSR110ID
75	96.0A	3.5	87IUH6FC	50-200A	FLSR125ID
100	124.0A	4	87JUH6FC	50-200A	FLSR175ID
125	156.0A	5	87LPU6FC	55-250A	FLSR225ID
150	180.0A	5	87LPU6FC	55-250A	FLSR250ID
200	240.0A	5	87LPU6FC	55-250A	FLSR300ID

GLOSSARY OF ABBREVIATIONS

AC	=	ALTERNATING CURRENT
AF	=	ACRE FEET
AI	=	ACRE INCH
ANSI	=	AMERICAN NATIONAL STANDARDS INSTITUTE
API	=	AMERICAN PETROLEUM INSTITUTE
ASME	=	AMERICAN SOCIETY OF MECHANICAL ENGINEERS
ASTM	=	AMERICAN SOCIETY FOR TESTING AND MATERIALS
AWG	=	AMERICAN WIRE GAUGE
AWWA	=	AMERICAN WATER WORKS ASSOCIATION
BSPT	=	BRITISH STANDARD PIPE THREADS
BTU	=	BRITISH THERMAL UNIT
C	=	CELSIUS
CFS	=	CUBIC FEET PER SECOND
CHT	=	CHEMICAL HOSE THREADS
CLS	=	CUBIC LITRES PER SECOND
CM	=	CENTIMETER
CMIL	=	CIRCULAR MIL
CSA	=	CANADIAN STANDARDS ASSOCIATION
CTS	=	COPPER TUBE SIZE
DC	=	DIRECT CURRENT
DWV	=	DRAIN, WASTE & VENT
EMT	=	ELECTRICAL METALLIC TUBING
EPDM	=	ETHYLENE-PROPYLENE-DIENE-TERPOLYMER
EVA	=	ETHYLENE VINYL ACETATE
FGHT	=	FEMALE GARDEN HOSE THREAD
FHT	=	FEMALE HOSE THREADS
FIPT	=	FEMALE IRON PIPE THREADS
FNPT	=	FEMALE NATIONAL PIPE THREAD
FPS	=	FEET PER SECOND
GHT	=	GARDEN HOSE THREADS
GPH	=	GALLONS PER MINUTE
GPM	=	GALLONS PER MINUTE
GPS	=	GALLONS PER SECOND
HDPE	=	HIGH DENSITY POLYETHYLENE
HP	=	HORSE POWER
ID	=	INSIDE DIAMETER
IPS	=	IRON PIPE SIZE
IPT	=	IRON PIPE THREADS

KCMIL	=	ONE THOUSAND CIRCULAR MILS
LPS	=	LITRES PER SECOND
MCM	=	ONE THOUSAND CIRCULAR MILS
MGHT	=	MALE GARDEN HOSE THREAD
MHT	=	MALE HOSE THREADS
MIL	=	A UNIT OF LENGTH EQUAL TO 1/1000 INCH
MIPT	=	MALE IRON PIPE THREADS
MM	=	A UNIT OF LENGTH EQUAL TO 1/1000 METER
MNPT	=	MALE NATIONAL PIPE THREAD
MSDS	=	MATERIAL SAFETY DATA SHEET
NBR	=	NITRILE-BUTADIENE
NEC	=	NATIONAL ELECTRIC CODE
NEMA	=	NATIONAL ELECTRICAL MANUFACTURER'S ASSOCIATION
NH	=	NATIONAL HOSE THREAD
NHT	=	NATIONAL HOSE THREAD
NPSH	=	NATIONAL PIPE STRAIGHT HOSE
NPSM	=	NATIONAL PIPE STRAIGHT MECHANICAL
NPT	=	NATIONAL PIPE TAPERED THREAD
NSF	=	NATIONAL SANITATION FOUNDATION
NST	=	NATIONAL HOSE THREAD (also known as) NATIONAL STANDARD THREAD
OD	=	OUTSIDE DIAMETER
ORP	=	OXIDATION REDUCTION POTENTIAL
PE	=	POLYETHYLENE
pH	=	POTENTIAL HYDROGEN
PIP	=	PLASTIC IRRIGATION PIPE SIZE
PSI	=	POUNDS PER SQUARE INCH
PTFE	=	VERSATILE POLYMER, POLYTETRAFLUOROETHYLENE (TEFLON)
PVC	=	POLY VINYL CHLORIDE
SBR	=	STYRENE-BUTADIENE RUBBER
TDH	=	TOTAL DYNAMIC HEAD
TOE	=	THREADED ONE END
UHMW	=	ULTRA HIGH MOLECULAR WEIGHT
UL	=	UNDERWRITERS' LABORATORIES, INC.
UV	=	ULTRA-VIOLET
V	=	VOLT
WOG	=	WATER, OIL AND GAS (PRESSURE RATING)
WP	=	WORKING PRESSURE
XLPE	=	CROSS LINKED POLYETHYLENE

INTRO | 1. ELECTRICAL | 2. PUMP Acc. | 3. HOSE, PE PIPE & Acc. | 4. IPS, PIP PIPE & Acc. | 5. SURFACE | 6. SPRINKLERS | 7. TRAVELER & WHEEL MOVE | 8. PIVOT | 9. TURF | 10. LOW VOLUME | 11. FILTERS | 12. INJECTION | 13. HARDWARE | INDEX

TECHNICAL RESOURCES

FLOW	
1 GAL. /MIN.	.002228 CU. FT./SEC
1 GAL. /MIN.	.13368 CU. FT./MIN
1 GAL. /MIN.	8.0208 CU. FT./HR
1 GAL. /MIN.	.0044192 ACRE FT./24 HRS
1 GAL. /MIN.	.06309 LTRS./SEC.
1 GAL. /MIN.	3.78533 LTRS./MIN.
1 CU. FT./SEC	448.83 GPM
1 CU. FT./SEC	.992 ACRE IN./HR
1 CU.FT./SEC	.0283 CU. MTR/SEC.
1 CU. MTR/MIN.	664.2 GPM
1 LTR./SEC	15.852 GPM
1 ACRE IN/HR	452.57 GPM
1 ACRE FT./DAY	226.3 GPM
1 MIL. GAL/DAY	694.4 GPM

VOLUME	
1 OUNCE	16 GRAMS
1 QUART	32 OUNCES
1 QUART	2 PINTS
1 QUART	.9463 LITERS
1 GALLON	4 QUARTS
1 GALLON	.833 IMPERIAL GALLON
1 GALLON	231 CUBIC INCHES
1 GALLON	0.13368 CUBIC METERS
1 GALLON	.00379 CUBIC METERS
1 GALLON	3.7854 LITERS
1 MIL. GAL.	3.06989 ACRE FEET
1 LITER	1.057 QUARTS
1 LITER	2.113 PINTS
1 LITER	.2642 GALLONS
1 LITER	.03501 CUBIC FEET
1 LITER	61.02 CUBIC INCHES
1 ACRE INCH	27,154 GALLONS
1 ACRE FOOT	325,851 GALLONS
1 ACRE FOOT	43,560 CUBIC FEET
1 CUBIC FOOT	1,728 CUBIC INCHES
1 CUBIC FOOT	7.48052 GALLONS
1 CUBIC FOOT	28.32 LITERS
1 CUBIC YARD	27 CUBIC FEET
1 CUBIC YARD	202 GALLONS
1 CUBIC METER	264.2 GALLONS
1 CUBIC METER	1,000 LITERS

AREA	
1 SQ. INCH	6.4516 SQ. CENTM.
1 SQ. FOOT	144 SQ. INCHES
1 SQ. FOOT	.0929 SQ. MTR
1 SQ. YARD	9 SQ. FEET
1 SQ. METER	10.76 SQ. FEET
1 SQ. ROD	272.25 SQ. FEET
1 SQ. ROD	30.25 SQ. YARDS
1 SQ. MILE	640 ACRES
1 SQ. MILE	2.5899 SQ. KILOMETERS
1 ACRE	43,560 SQ FEET
1 ACRE	4,840 SQ. YARDS
1 ACRE	208.7 FT. SQUARE
1 ACRE	160 SQ. RODS
1 ACRE	.405 HECTARES
1 ACRE	.0040469 SQ KILOMETERS
1 SECTION	640 ACRES
1 HECTARE	10,000 SQ. METERS
1 HECTARE	107,639 SQ. FEET
1 HECTARE	11,959.9 SQ. YDS
1 HECTARE	2.4711 ACRES
1 SQ KILOMETER	.3861 SQ MILES
1 SQ KILOMETER	247.104 ACRES

POWER	
1 HORSEPOWER	33,000 FT.LBS./MIN
1 HORSEPOWER	746 WATTS
1 HORSEPOWER	.746 KILOWATTS
1 HORSEPOWER	42.44 BTU/MIN.
1 KILOWATT	56.92 BTU/MIN.
1 KILOWATT	1.341 HORSEPOWER
1 KILOWATT HR.	3,413 BTU

LENGTH	
1 CENTIMETER	.3937 INCHES
1 INCH	2.54 CENTIMETERS
1 CUBIT	18 INCHES
1 FOOT	.3048 METERS
1 METER	39.37 INCHES
1 METER	1.09361 YARDS
1 YARD	.91440 METERS
1 ROD	16.5 FEET
1 ROD	5.5 YARDS
1 CHAIN	4 RODS
1 CHAIN	66 FEET
1 MILE	320 RODS
1 MILE	5,280 FEET
1 MILE	1.609 KILOMETERS
1 KILOMETER	3280.84 FEET
1 KILOMETER	.62137 MILES

WEIGHT	
1 US GALLON WATER	8.3357 LBS.
1 CU. FT. WATER	62.3354 LBS.
1 IMPERIAL GALLON	10.0 LBS.
1 GRAM	.033818 FLUID OUNCES
1 FLUID OUNCE	29.57 GRAMS
1 LITER	2.2 LBS.
1 POUND	16 OUNCES
1 GRAM	.03527 OUNCES
1 OUNCE	28.35 GRAMS
1 KILOGRAM	2.2046 LBS.
EARTH, UNDISTURBED	100 LBS./CU.FT.
CONCRETE (PLAIN)	140 LBS./CU.FT.
CONCRETE (REINF.)	150 LBS./CU.FT.

PRESSURE	
1 PSI	2.309 FT. OF HEAD
1 PSI	144 LBS./SQ.FT.
1 PSI	.06804 ATMOSPHERES
1 PSI	.0689 BARS
1 PSI	6.895 KILOPASCALS
1 PSI	703.1 KG./SQ. MTR.
1 KILOGRAM/SQ. CM.	14.223 PSI
1 ATMOSPHERE	14.6963 PSI
1 ATMOSPHERE	1.033 KG./SQ.CM.
1 BAR	14.50 PSI
1 BAR	2,089 LBS./SQ.FT.
1 BAR	.9869 ATMOSPHERES
1 FT. WATER	.8826 IN. OF MERCURY
1 FT. WATER	304.8 KG./SQ.FT.
1 FT. WATER	.0295 ATMOSPHERES
1 FT. WATER	62.3554 LBS./SQ.FT.
1 FT. WATER	.4335 PSI

VELOCITY	
1 FT./SEC.	.681818 MI./HR.
1 FT./SEC.	.3048 MTR./SEC.
1 FT./SEC.	1.09728 KM./HR.
1 MI./HR.	1.4666 FT./SEC.
1 MI./HR.	.44704 MTR./SEC.
1 MI./HR.	1.609344 KM./HR.
1 MTR./SEC.	3.28084 FT./SEC.
1 MTR./SEC	2.2369 MI./HR.
1 MTR./SEC	3.6 KM./HR.
1 KM./HR	.91134 FT./SEC.
1 KM/ HR	.62137 MI./HR.
1 KM./HR.	.2777 MTR./SEC.

TEMPERATURE CONVERSION

-459° to 0°			1° to 60°			61° to 290°			300° to 890°			900° to 3000°		
C	C F	F	C	C F	F	C	C F	F	C	C F	F	C	C F	F
-273	-459.4		-17.2	1	33.8	16.1	61	141.8	149	300	572	482	900	1652
-268	-450		-16.7	2	35.6	16.7	62	143.6	154	310	590	488	910	1670
-262	-440		-16.1	3	37.4	17.2	63	145.4	160	320	608	493	920	1688
-257	-430		-15.6	4	39.2	17.8	64	147.2	166	330	626	499	930	1706
-251	-420		-15.0	5	41.0	18.3	65	149.0	171	340	644	504	940	1724
-246	-410		-14.4	6	42.8	18.9	66	150.8	177	350	662	510	950	1742
-240	-400		-13.9	7	44.6	19.4	67	152.6	182	360	680	516	960	1760
-234	-390		-13.3	8	46.4	20.0	68	154.4	188	370	698	521	970	1778
-229	-380		-12.8	9	48.2	20.6	69	156.2	193	380	716	527	980	1796
-223	-370		-12.2	10	50.0	21.1	70	158.0	199	390	734	532	990	1814
-218	-360		-11.7	11	51.8	21.7	71	159.8	204	400	752	538	1000	1832
-212	-350		-11.1	12	53.6	22.2	72	161.6	210	410	770	549	1020	1868
-207	-340		-10.6	13	55.4	22.8	73	163.4	216	420	788	560	1040	1904
-201	-330		-10.0	14	57.2	23.3	74	165.2	221	430	806	571	1060	1940
-196	-320		-9.4	15	59.0	23.9	75	167.0	227	440	824	582	1080	1976
-190	-310		-8.9	16	60.8	24.4	76	168.8	232	450	842	593	1100	2012
-184	-300		-8.3	17	62.6	25.0	77	170.6	238	460	860	604	1120	2048
-179	-290		-7.8	18	64.4	25.6	78	172.4	243	470	878	616	1140	2084
-173	-280		-7.2	19	66.2	26.1	79	174.2	249	480	896	627	1160	2120
-169	-273	-459.4	-6.7	20	68.0	26.7	80	176.0	254	490	914	638	1180	2156
-168	-270	-454	-6.1	21	69.8	27.2	81	177.8	260	500	932	649	1200	2192
-162	-260	-436	-5.6	22	71.6	27.8	82	179.6	266	510	950	660	1220	2228
-157	-250	-418	-5.0	23	73.4	28.3	83	181.4	271	520	968	671	1240	2264
-151	-240	-400	-4.4	24	75.2	28.9	84	183.2	277	530	986	682	1260	2300
-146	-230	-382	-3.9	25	77.0	29.4	85	185.0	282	540	1004	693	1280	2336
-140	-220	-364	-3.3	26	78.8	30.0	86	186.8	288	550	1022	704	1300	2372
-134	-210	-346	-2.8	27	80.6	30.6	87	188.6	293	560	1040	732	1350	2462
-129	-200	-328	-2.2	28	82.4	31.1	88	190.4	299	570	1058	760	1400	2552
-123	-190	-310	-1.7	29	84.2	31.7	89	192.2	304	580	1076	788	1450	2642
-118	-180	-292	-1.1	30	86.0	32.2	90	194.0	310	590	1094	816	1500	2732
-112	-170	-274	-0.6	31	87.8	32.8	91	195.8	316	600	1112	843	1550	2822
-107	-160	-256	0.0	32	89.6	33.3	92	197.6	321	610	1130	871	1600	2912
-101	-150	-238	0.6	33	91.4	33.9	93	199.4	327	620	1148	899	1650	3002
-96	-140	-220	1.1	34	93.2	34.4	94	201.2	332	630	1166	927	1700	3092
-90	-130	-202	1.7	35	95.0	35.0	95	203.0	338	640	1184	954	1750	3182
-84	-120	-184	2.2	36	96.8	35.6	96	204.8	343	650	1202	983	1800	3272
-79	-110	-166	2.8	37	98.6	36.1	97	206.6	349	660	1220	1010	1850	3362
-73	-100	-148	3.3	38	100.4	36.7	98	208.4	354	670	1238	1038	1900	3452
-68	-90	-130	3.9	39	102.2	37.2	99	210.2	360	680	1256	1066	1950	3542
-62	-80	-112	4.4	40	104.0	37.8	100	212.0	366	690	1274	1093	2000	3632
-57	-70	-94	5.0	41	105.8	43	110	230	371	700	1292	1121	2050	3722
-51	-60	-76	5.6	42	107.6	49	120	248	377	710	1310	1149	2100	3812
-46	-50	-58	6.1	43	109.4	54	130	266	382	720	1328	1177	2150	3902
-40	-40	-40	6.7	44	111.2	60	140	284	388	730	1346	1204	2200	3992
-34	-30	-22	7.2	45	113.0	66	150	302	393	740	1364	1232	2250	4082
-29	-20	-4	7.8	46	114.8	71	160	320	399	750	1382	1260	2300	4172
-23	-10	14	8.3	47	116.6	77	170	338	404	760	1400	1288	2350	4262
-17.8	0	32	8.9	48	118.4	82	180	356	410	770	1418	1316	2400	4352
			9.4	49	120.2	88	190	374	416	780	1436	1343	2450	4442
			10.0	50	122.0	93	200	392	421	790	1454	1371	2500	4532
			10.6	51	123.8	99	210	410	427	800	1472	1399	2550	4622
			11.1	52	125.6	100	212	413.6	432	810	1490	1427	2600	4712
			11.7	53	127.4	104	220	428	438	820	1508	1454	2650	4802
			12.2	54	129.2	110	230	446	443	830	1526	1482	2700	4892
			12.8	55	131.0	116	240	464	449	840	1544	1510	2750	4982
			13.3	56	132.8	121	250	482	454	850	1562	1538	2800	5072
			13.9	57	134.6	127	260	500	460	860	1580	1566	2850	5162
			14.4	58	136.4	132	270	518	466	870	1598	1593	2900	5252
			15.0	59	138.2	138	280	536	471	880	1616	1621	2950	5342
			15.6	60	140.0	143	290	554	477	890	1634	1649	3000	5432

INTRO	1. ELECTRICAL
	2. PUMP ACC.
	3. HOSE, PE PIPE & ACC.
	4. IPS, PIP PIPE & ACC.
	5. SURFACE
	6. SPRINKLERS
	7. TRAVELER & WHEEL MOVE
	8. PIVOT
	9. TURN
	10. LOW VOLUME
	11. FILTERS
	12. INJECTION
	13. HARDWARE
	INDEX

TECHNICAL RESOURCES

FORMULAS FOR CALCULATING	
VOLUME OF A-	
CUBE	AREA OF BASE x HEIGHT
PYRAMID	1/3 AREA OF BASE x HEIGHT
SPHERE	DIAMETER CUBED x .5236
AREA OF A-	
CIRCLE	RADIUS SQUARED x 3.1416
SQUARE	ONE SIDE SQUARED
TRIANGLE	1/2 BASE x HEIGHT
RECTANGLE	LENGTH x WIDTH
PARALLELOGRAM	BASE x HEIGHT
CIRCUMFERENCE OF A-	
CIRCLE	DIAMETER x 3.1416
ELEVATION VS. PRESSURE	
1 FT. OF RISE OR FALL	= .4335 PSI
1 PSI. OF RISE OR FALL	= 2.309 FT.
FRICITION LOSS FOR 100 FT. OF PIPE (HAZEN-WILLIAMS)	
$F = 0.2086 \left(\frac{100}{C}\right)^{1.85} \times \frac{Q^{1.85}}{D^{4.8655}}$	
WHERE:	
F = PRESSURE LOSS IN FT. OF HEAD/100 FT.	
C = COEFFICIENT OF INSIDE PIPE ROUGHNESS	
Q = FLOW IN GALLONS PER MINUTE	
D = INSIDE PIPE DIAMETER IN INCHES	
TO CONVERT ABOVE INFO. INTO PSI	
$PSI = \frac{F}{2.309}$	
F = Elevation Change (In Feet)	
VELOCITY	
$V = \frac{GPM}{2.45 \times ID^2}$	
WHERE:	
V = VELOCITY IN FEET PER SECOND	
GPM = GALLONS PER MINUTE	
ID = INSIDE PIPE DIAMETER IN INCHES	
POWER	
(BHP) BRAKE HORSE POWER	= $\frac{GPM \times TDH (FT.)}{3960 \times PUMP \text{ EFFICIENCY}}$
PUMP EFFICIENCY	= $\frac{GPM \times TDH (FT.)}{3960 \times BHP \text{ TO PUMP}}$
GPM = GALLONS PER MINUTE	
TDH = TOTAL DYNAMIC HEAD (IN FEET)	
PRECIPITATION RATE	
APPLICATION RATE (INCHES/HOUR)	= $\frac{(GPM/SPKLR.)96.25}{S \times L}$
S = SPKLR. SPACING ALONG LATERALS IN FT.	
L = SPACING BETWEEN LATERALS IN FEET	
NEW NOZZLE FLOWS	
$Q \text{ NEW} = \sqrt{\frac{P \text{ NEW}}{P \text{ OLD}}} \times Q \text{ OLD}$	
WHERE:	
Q = FLOW	P = PSI

FRACTIONS TO DECIMALS TO MILLIMETERS		
Fractions	Decimals	Millimeters
1/64	0.015625	0.397
1/32	0.03125	0.794
3/64	0.046875	1.191
1/16	0.0625	1.588
5/64	0.078125	1.984
3/32	0.09375	2.381
7/64	0.109375	2.778
1/8	0.1250	3.175
9/64	0.140625	3.572
5/32	0.15625	3.969
11/64	0.171875	4.366
3/16	0.1875	4.763
13/64	0.203125	5.159
7/32	0.21875	5.556
15/64	0.234375	5.953
1/4	0.2500	6.350
17/64	0.265625	6.747
9/32	0.28125	7.144
19/64	0.296875	7.541
5/16	0.3125	7.938
21/64	0.328125	8.334
11/32	0.34375	8.731
23/64	0.359375	9.128
3/8	0.3750	9.525
25/64	0.390625	9.922
13/32	0.40625	10.319
27/64	0.421875	10.716
7/16	0.4375	11.113
29/64	0.453125	11.509
15/32	0.46875	11.906
31/64	0.484375	12.303
1/2	0.5000	12.700
33/64	0.515625	13.097
17/32	0.53125	13.494
35/64	0.546875	13.891
9/16	0.5625	14.288
37/64	0.578125	14.684
19/32	0.59375	15.081
39/64	0.609375	15.478
5/8	0.6250	15.875
41/64	0.640625	16.272
21/32	0.65625	16.669
43/64	0.671875	17.066
11/16	0.6875	17.463
45/64	0.703125	17.859
23/32	0.71875	18.256
47/64	0.734375	18.653
3/4	0.7500	19.050
49/64	0.765625	19.447
25/32	0.78125	19.844
51/64	0.796875	20.241
13/16	0.8125	20.638
53/64	0.828125	21.034
27/32	0.84375	21.431
55/64	0.859375	21.828
7/8	0.8750	22.225
57/64	0.890625	22.622
29/32	0.90625	23.019
59/64	0.921875	23.416
15/16	0.9375	23.813
61/64	0.953125	24.209
31/32	0.96875	24.606
63/64	0.984375	25.003
1	1.0000	25.400

1) 0.001" = 0.0254 mm
1mm = 0.03937"

TO CALCULATE	EQUATION	EXAMPLE
AREA IRRIGATED BY A CENTER PIVOT	$AC = \frac{(PL + EGR)^2}{13866}$ <p>AC = ACRES IRRIGATED PL = PIVOT LENGTH (FT.) EGR = END GUN RADIUS (FT.)</p>	FIND THE ACREAGE IRRIGATED BY A 1000' PIVOT WITH AN END GUN WITH A 130' RADIUS $AC = \frac{(1000 + 130)^2}{13866}$ AC = 92 ACRES
HOURS PER PIVOT REVOLUTION	$HPR = \frac{0.105 (LTD)}{GS}$ <p>HPR = HOURS PER REVOLUTION (HR.) LTD = DISTANCE TO LAST TOWER (FT.) GS = TOWER GROUND SPEED (FT./MIN)</p>	FIND THE AMOUNT OF TIME NEEDED FOR THE PIVOT ABOVE TO COMPLETE A REVOLUTION IF THE LAST TOWER MOVES AT 10.2 FT. PER. MINUTE. THE 1000 FOOT LENGTH INCLUDES A 40 FOOT END BOOM. LTD = 1000 FT. - 40 FT. = 960 FT. $HPR = \frac{0.105(960)}{10.2}$ HPR = 9.9 HOURS PER REVOLUTION
AMOUNT OF WATER APPLIED BY A CENTER PIVOT	$D = \frac{(30.64 Q HPR)}{(PL + EGR)^2}$ <p>D = DEPTH OF WATER APPLIED (IN.) Q = FLOWRATE (GPM) HPR = HOURS PER REVOLUTION (HR.) PL = PIVOT LENGTH (FT.) EGR = END GUN RADIUS (FT.)</p>	DETERMINE THE AMOUNT OF WATER APPLIED FOR THE 1000 FOOT PIVOT CONSIDERED ABOVE AT 700 GPM. $D = \frac{30.64 (700) (9.9)}{(1000 + 130)^2}$ $D = \frac{212,365}{1,276,900}$ D = 0.17 INCH
REQUIRED FLOW FOR A GIVEN PIVOT SPRINKLER	$Q_s = \frac{DFP (Q/AC) SS}{6933}$ <p>Q_s = SPRINKLER FLOWRATE (GPM) DFP = DISTANCE FROM THE PIVOT (FT.) Q = TOTAL PIVOT FLOWRATE (GPM) AC = ACRES IRRIGATED BY PIVOT SS = SPRINKLER SPACING (FT.)</p>	DETERMINE THE FLOWRATE REQUIRED BY A SPRINKLER LOCATED 750 FEET FROM THE PIVOT, IF THE SPRINKLER SPACING AT THAT POINT IS 17 FEET. $Q_s = \frac{(750) (700/92) (17)}{6933}$ $Q_s = \frac{97,011}{6933}$ Q _s = 14.0 GPM
CALCULATING NOZZLE FLOWRATE WITH CHANGING PRESSURE	$Q_1 / Q_2 = (P_1)^{1/2} / (P_2)^{1/2}$ $Q_2 = Q_1 (P_2 / P_1)^{1/2}$ <p>Q₁ = KNOWN NOZZLE FLOW (GPM) Q₂ = NOZZLE FLOW TO DETERMINE (GPM) P₁ = PRESSURE (PSI) FOR Q₁ P₂ = PRESSURE (PSI) FOR Q₂</p>	DETERMINE THE FLOWRATE OF A #30 3TN NOZZLE AT 15 PSI, KNOWING THE FLOW @ 10 PSI IS 4.94 GPM $Q_2 = 4.94 (15/10)^{1/2}$ Q ₂ = 6.05 GPM

NOTE: THE INFORMATION PRINTED ON THIS PAGE IS SUPPLIED COURTESY OF NELSON IRRIGATION CORPORATION, AND HAS BEEN EXTRACTED FROM NELSON'S BROCHURE ENTITLED "CENTER PIVOT SPRINKLER DESIGN - TECHNICAL APPLICATION GUIDE." THIS BROCHURE IS AN EXCELLENT SOURCE MANUAL FOR YOUR SALES PEOPLE. PLEASE LET US KNOW IF YOU NEED ONE.

INTRO
1. ELECTRICAL
2. PUMP Acc.
3. HOSE, PE PIPE & Acc.
4. IPS, PIP Pipe & Acc.
5. SURFACE
6. SPRINKLERS
7. TRAVELER & WHEEL MOVE
8. PIVOT
9. TURF
10. LOW VOLUME
11. FILTERS
12. INJECTION
13. HARDWARE
INDEX

FRICTION LOSS CHARACTERISTICS

PVC CLASS 100 IPS PLASTIC PIPE

(1120, 1220) SDR 41 C = 150

PSI LOSS PER 100 FEET OF PIPE (PSI/100FT)

Sizes 3.5" thru 8" Flow GPM 1 thru 850

Size OD ID Wall THK	3.50		4.00		6.00		8.00	
	4.00	3.804	4.500	4.280	6.625	6.301	8.625	8.205
	0.098		0.110		0.162		0.210	
Flow GPM	Velocity FPS	PSI Loss	Velocity FPS	PSI Loss	Velocity FPS	PSI Loss	Velocity FPS	PSI Loss
1								
2								
3								
4								
5								
6								
7								
8								
9								
10	0.28	0.00						
11	0.31	0.01						
12	0.33	0.01						
14	0.39	0.01	0.31	0.00				
16	0.45	0.01	0.35	0.01				
18	0.50	0.01	0.40	0.01				
20	0.56	0.02	0.44	0.01				
22	0.62	0.02	0.48	0.01				
24	0.67	0.02	0.53	0.01				
26	0.73	0.03	0.57	0.02				
28	0.78	0.03	0.62	0.02				
30	0.84	0.03	0.66	0.02				
35	0.98	0.05	0.77	0.03	0.35	0.00		
40	1.12	0.06	0.89	0.03	0.41	0.01		
45	1.26	0.07	1.00	0.04	0.46	0.01		
50	1.40	0.09	1.11	0.05	0.51	0.01		
55	1.55	0.11	1.22	0.06	0.56	0.01		
60	1.69	0.13	1.33	0.07	0.61	0.01		
65	1.83	0.15	1.44	0.08	0.66	0.01		
70	1.97	0.17	1.55	0.09	0.71	0.01		
75	2.11	0.19	1.67	0.11	0.77	0.02	0.45	0.00
80	2.25	0.21	1.78	0.12	0.82	0.02	0.48	0.01
85	2.39	0.24	1.89	0.13	0.87	0.02	0.51	0.01
90	2.53	0.27	2.00	0.15	0.92	0.02	0.54	0.01
95	2.67	0.29	2.11	0.17	0.97	0.03	0.57	0.01
100	2.81	0.32	2.22	0.18	1.02	0.03	0.60	0.01
110	3.10	0.39	2.44	0.22	1.13	0.03	0.66	0.01
120	3.38	0.45	2.67	0.26	1.23	0.04	0.72	0.01
130	3.66	0.53	2.89	0.30	1.33	0.05	0.78	0.01
140	3.94	0.60	3.11	0.34	1.43	0.05	0.84	0.01
150	4.22	0.69	3.34	0.39	1.54	0.06	0.90	0.02
160	4.51	0.77	3.56	0.44	1.64	0.07	0.96	0.02
170	4.79	0.86	3.78	0.49	1.74	0.07	1.03	0.02
180	5.07	0.96	4.00	0.54	1.84	0.08	1.09	0.02
190	5.35	1.06	4.23	0.60	1.95	0.09	1.15	0.03
200	5.63	1.17	4.45	0.66	2.05	0.10	1.21	0.03
225	6.34	1.45	5.01	0.82	2.31	0.12	1.36	0.03
250	7.04	1.77	5.56	1.00	2.56	0.15	1.51	0.04
275	7.75	2.11	6.12	1.19	2.82	0.18	1.66	0.05
300	8.45	2.48	6.68	1.39	3.08	0.21	1.81	0.06
325	9.16	2.87	7.23	1.62	3.33	0.25	1.96	0.07
350	9.86	3.29	7.79	1.86	3.59	0.28	2.12	0.08
375	10.57	3.74	8.35	2.11	3.85	0.32	2.27	0.09
400	11.27	4.22	8.90	2.38	4.11	0.36	2.42	0.10
425	11.98	4.72	9.46	2.66	4.36	0.40	2.57	0.11
450	12.68	5.24	10.02	2.96	4.62	0.45	2.72	0.12
475	13.39	5.80	10.57	3.27	4.88	0.50	2.87	0.14
500	14.09	6.38	11.13	3.59	5.13	0.55	3.03	0.15
550	15.50	7.61	12.24	4.29	5.65	0.65	3.33	0.18
600	16.91	8.94	13.36	5.04	6.16	0.77	3.63	0.21
650	18.32	10.36	14.47	5.84	6.67	0.89	3.93	0.25
700	19.73	11.89	15.59	6.70	7.19	1.02	4.24	0.28
750			16.70	7.61	7.70	1.16	4.54	0.32
800			17.81	8.58	8.22	1.31	4.84	0.36
850			18.93	9.60	8.73	1.46	5.15	0.40

FRICTION LOSS CALCULATIONS FOR MULTIPLE OUTLETS ON A LATERAL

The factors below are based on the following assumptions:

- If the lateral is composed of a single pipe size;
- There is no outflow past the downstream outlet;
- The distance between the pipeline inlet and the first outlet is equal to one full outlet spacing;
- Hydraulic characteristics (e.g., pipe friction factor and pipe diameter) remain constant along the length of the pipeline;
- Then the friction loss can be calculated and the answer multiplied by a factor determined by the number of outlets from the lateral.

No. of outlets	Factor	No. of Outlets	Factor	No. of Outlets	Factor
1	1	5	.380	30	.350
2	.512	10	.365	40	.349
3	.434	15	.357	50	.348
4	.405	20	.354	100	.347

VINYLFLOW® / IRONSIDES® / VINYLFLOW® EZ-LITE™

PSI LOSS PER 100 FEET

GPM	1.5"	2"	2.5"	3"	4"	6"	8"	10"	12"	14"	16"
20	1.2										
30	2.4										
40	5.1	1.1									
50	6.0										
60		2.4	1.4								
80		4.1	1.9	1.0							
90	17.0										
100		6.0	2.8	1.2							
120				1.8							
140				2.2							
160				2.6	0.6						
180				3.3	0.7						
200		22	7		0.8						
220					1.0						
240					1.1		0.2				
250				5							
260					1.3	0.2					
280					1.4	0.2					
300					1.6	0.2					
340						0.3					
350			22								
380						0.4					
420						0.5					
460						0.6					
500					4	0.7					
540						0.8					
580				22		0.9					
620						1.0					
660						1.1					
1,200						3.0					
1,250					22						
1,800							1.5				
2,500								1.0			
3,500									0.8		
3,630						22					
5,000							11			0.6	
6,000											0.4
8,000								8			
12,000									8		
15,000										5	
16,000											30

Note: Shaded areas of the chart indicate velocities over 5' per second. **Use with Caution.**

FRICTION LOSS CHARACTERISTICS

PVC CLASS 160 IPS PLASTIC PIPE

(1120, 1220) SDR 26 C = 150

PSI LOSS PER 100 FEET OF PIPE (PSI/100FT)

Sizes 1.25" thru 10" Flow GPM 1 thru 1250

Note: Shaded areas of the chart indicate velocities over 5' per second. **Use with Caution.**

Size OD ID Wall THK	1.25 1.660 1.532 0.064		1.50 1.900 1.754 0.073		2.00 2.375 2.193 0.091		2.50 2.875 2.655 0.110		3.00 3.500 3.230 0.135		4.00 4.50 4.154 0.173		5.00 5.563 5.133 0.214		6.00 6.625 6.115 0.225		8.00 8.625 7.961 0.332		10.00 10.750 9.924 0.413		Size OD ID Wall THK
Flow GPM	Velocity FPS	PSI Loss	Velocity FPS	PSI Loss	Velocity FPS	PSI Loss	Velocity FPS	PSI Loss	Velocity FPS	PSI Loss	Velocity FPS	PSI Loss	Velocity FPS	PSI Loss	Velocity FPS	PSI Loss	Velocity FPS	PSI Loss	Velocity FPS	PSI Loss	Flow GPM
1	0.17	0.01	0.13	0.00																	1
2	0.34	0.02	0.26	0.01	0.16	0.00															2
3	0.52	0.04	0.39	0.02	0.25	0.01															3
4	0.69	0.07	0.53	0.04	0.33	0.01	0.23	0.00													4
5	0.86	0.11	0.66	0.05	0.42	0.02	0.28	0.01													5
6	1.04	0.15	0.79	0.08	0.50	0.03	0.34	0.01	0.23	0.00											6
7	1.21	0.20	0.92	0.10	0.59	0.03	0.40	0.01	0.27	0.01											7
8	1.39	0.25	1.06	0.13	0.67	0.04	0.46	0.02	0.31	0.01											8
9	1.56	0.31	1.19	0.16	0.76	0.05	0.52	0.02	0.35	0.01											9
10	1.73	0.38	1.32	0.20	0.84	0.07	0.57	0.03	0.39	0.01											10
11	1.91	0.45	1.45	0.23	0.93	0.08	0.63	0.03	0.43	0.01											11
12	2.08	0.53	1.59	0.28	1.01	0.09	0.69	0.04	0.46	0.01	0.28	0.00									12
14	2.43	0.71	1.85	0.37	1.18	0.12	0.81	0.05	0.54	0.02	0.33	0.01									14
16	2.78	0.91	2.12	0.47	1.35	0.16	0.92	0.06	0.62	0.02	0.37	0.01									16
18	3.12	1.13	2.38	0.58	1.52	0.20	1.04	0.08	0.70	0.03	0.42	0.01									18
20	3.47	1.37	2.65	0.71	1.69	0.24	1.15	0.09	0.78	0.04	0.47	0.01									20
22	3.82	1.64	2.91	0.85	1.86	0.29	1.27	0.11	0.86	0.04	0.52	0.01	0.34	0.00							22
24	4.17	1.92	3.18	1.00	2.03	0.34	1.38	0.13	0.93	0.05	0.56	0.02	0.37	0.01							24
26	4.51	2.23	3.44	1.15	2.20	0.39	1.50	0.15	1.01	0.06	0.61	0.02	0.40	0.01							26
28	4.86	2.56	3.71	1.32	2.37	0.45	1.62	0.18	1.09	0.07	0.66	0.02	0.43	0.01							28
30	5.21	2.91	3.97	1.50	2.54	0.51	1.73	0.20	1.17	0.08	0.70	0.02	0.46	0.01							30
35	6.08	3.87	4.64	2.00	2.96	0.68	2.02	0.27	1.36	0.10	0.82	0.03	0.54	0.01	0.38	0.00					35
40	6.95	4.95	5.30	2.56	3.39	0.86	2.31	0.34	1.56	0.13	0.94	0.04	0.61	0.01	0.43	0.01					40
45	7.82	6.16	5.96	3.19	3.81	1.08	2.60	0.42	1.75	0.16	1.06	0.05	0.69	0.02	0.49	0.01					45
50	8.69	7.49	6.63	3.88	4.24	1.31	2.89	0.52	1.95	0.20	1.18	0.06	0.77	0.02	0.54	0.01					50
55	9.56	8.93	7.29	4.62	4.66	1.56	3.18	0.62	2.15	0.24	1.30	0.07	0.85	0.02	0.60	0.01					55
60	10.43	10.49	7.95	5.43	5.09	1.83	3.47	0.72	2.34	0.28	1.41	0.08	0.92	0.03	0.65	0.01					60
65	11.29	12.17	8.62	6.30	5.51	2.12	3.76	0.84	2.54	0.32	1.53	0.09	1.00	0.03	0.70	0.01					65
70	12.16	13.96	9.28	7.23	5.93	2.44	4.05	0.96	2.73	0.37	1.65	0.11	1.08	0.04	0.76	0.02	0.45	0.00			70
75	13.03	15.86	9.94	8.21	6.36	2.77	4.34	1.09	2.93	0.42	1.77	0.12	1.16	0.04	0.81	0.02	0.48	0.01			75
80	13.90	17.88	10.60	9.25	6.78	3.12	4.63	1.23	3.12	0.47	1.89	0.14	1.23	0.05	0.87	0.02	0.51	0.01			80
85	14.77	20.00	11.27	10.35	7.21	3.49	4.91	1.38	3.32	0.53	2.00	0.16	1.31	0.06	0.92	0.02	0.54	0.01			85
90	15.64	22.23	11.93	11.51	7.63	3.88	5.20	1.53	3.51	0.59	2.12	0.17	1.39	0.06	0.98	0.03	0.57	0.01			90
95	16.51	24.58	12.59	12.72	8.05	4.29	5.49	1.69	3.71	0.65	2.24	0.19	1.47	0.07	1.03	0.03	0.61	0.01			95
100	17.38	27.03	13.26	13.99	8.48	4.72	5.78	1.86	3.91	0.72	2.36	0.21	1.54	0.08	1.09	0.03	0.64	0.01			100
110	19.12	32.24	14.58	16.69	9.33	5.63	6.36	2.22	4.30	0.86	2.60	0.25	1.70	0.09	1.20	0.04	0.70	0.01			110
120			15.91	19.61	10.18	6.61	6.94	2.61	4.69	1.01	2.83	0.30	1.85	0.11	1.30	0.05	0.77	0.01			120
130			17.24	22.74	11.02	7.67	7.52	3.03	5.08	1.17	3.07	0.34	2.01	0.12	1.41	0.05	0.83	0.01	0.53	0.00	130
140			18.56	26.09	11.87	8.80	8.10	3.47	5.47	1.34	3.31	0.39	2.16	0.14	1.52	0.06	0.90	0.02	0.57	0.01	140
150			19.89	29.64	12.72	10.00	8.68	3.94	5.86	1.52	3.54	0.45	2.32	0.16	1.63	0.07	0.96	0.02	0.62	0.01	150
160					13.57	11.27	9.26	4.45	6.25	1.71	3.78	0.50	2.47	0.18	1.74	0.08	1.02	0.02	0.66	0.01	160
170					14.42	12.61	9.83	4.97	6.64	1.92	4.01	0.56	2.63	0.20	1.85	0.09	1.09	0.02	0.70	0.01	170
180					15.27	14.02	10.41	5.53	7.03	2.13	4.25	0.63	2.78	0.22	1.96	0.10	1.15	0.03	0.74	0.01	180
190					16.11	15.49	10.99	6.11	7.43	2.35	4.49	0.69	2.94	0.25	2.07	0.11	1.22	0.03	0.78	0.01	190
200					16.96	17.03	11.57	6.72	7.82	2.59	4.72	0.76	3.09	0.27	2.18	0.12	1.28	0.03	0.82	0.01	200
225					19.08	21.19	13.02	8.36	8.79	3.22	5.31	0.95	3.48	0.34	2.45	0.14	1.44	0.04	0.93	0.01	225
250							14.47	10.16	9.77	3.91	5.91	1.15	3.87	0.41	2.72	0.18	1.60	0.05	1.03	0.02	250
275							15.91	12.12	10.75	4.67	6.50	1.37	4.25	0.49	3.00	0.21	1.77	0.06	1.13	0.02	275
300							17.36	14.24	11.73	5.49	7.09	1.61	4.64	0.58	3.27	0.25	1.93	0.07	1.24	0.02	300
325							18.81	16.51	12.70	6.36	7.68	1.87	5.03	0.67	3.54	0.29	2.09	0.08	1.34	0.03	325
350									13.68	7.30	8.27	2.15	5.41	0.77	3.81	0.33	2.25	0.09	1.44	0.03	350
375									14.66	8.29	8.86	2.44	5.80	0.87	4.09	0.37	2.41	0.10	1.55	0.04	375
400									15.64	9.35	9.45	2.75	6.19	0.98	4.36	0.42	2.57	0.12	1.65	0.04	400
425									16.62	10.46	10.04	3.07	6.58	1.10	4.63	0.47	2.73	0.13	1.76	0.04	425
450									17.59	11.62	10.63	3.42	6.96	1.22	4.90	0.52	2.89	0.14	1.86	0.05	450
475									18.57	12.85	11.23	3.78	7.35	1.35	5.18	0.58	3.05	0.16	1.96	0.05	475
500									19.55	14.13	11.82	4.15	7.74	1.48	5.45	0.63	3.21	0.18	2.07	0.06	500
550											13.00	4.96	8.51	1.77	6.00	0.76	3.54	0.21	2.27	0.07	550
600											14.18	5.82	9.29	2.08	6.54	0.89	3.86	0.25	2.48	0.08	600
650											15.36	6.75	10.06	2.41	7.09	1.03	4.18	0.29	2.69	0.10	650
700											16.55	7.75	10.83	2.77	7.63	1.18	4.50	0.33	2.89	0.11	700
750											17.73	8.80	11.61	3.14	8.18	1.34	4.82	0.37	3.10	0.13	750
800											18.91	9.92	12.38	3.54	8.72	1.51	5.15	0.42	3.31	0.14	800
850													13.16	3.96	9.27	1.69	5.47	0.47	3.52	0.16	850
900													13.93	4.41	9.81	1.88	5.79	0.52	3.72	0.18	900
950													14.71	4.87	10.36	2.08	6.11	0.58	3.93	0.20	950
1000													15.48	5.36	10.91	2.29	6.43	0.63	4.14	0.22	1000
1050													16.25	5.86	11.45	2.50	6.75	0.69	4.34	0.24	1050
1100					</																

FRICTION LOSS CHARACTERISTICS

PVC SCHEDULE 40 IPS PLASTIC PIPE

(1120, 1220) C = 150

PSI LOSS PER 100 FEET OF PIPE (PSI/100FT)

Sizes .75" thru 10" Flow GPM 1 thru 1250

Note: Shaded areas of the chart indicate velocities over 5' per second. **Use with Caution.**

Size OD ID Wall THK	0.75		1.00		1.25		1.50		2.00		2.50		3.00		4.00		6.00		8.00		Size OD ID Wall THK		
	Velocity FPS	PSI Loss	Velocity FPS	PSI Loss	Velocity FPS	PSI Loss	Velocity FPS	PSI Loss	Velocity FPS	PSI Loss	Velocity FPS	PSI Loss	Velocity FPS	PSI Loss	Velocity FPS	PSI Loss	Velocity FPS	PSI Loss	Velocity FPS	PSI Loss			
1	0.60	0.11	0.37	0.03	0.21	0.01	0.15	0.00													1		
2	1.20	0.39	0.74	0.12	0.42	0.03	0.31	0.02	0.19	0.00											2		
3	1.80	0.84	1.11	0.26	0.64	0.07	0.47	0.03	0.28	0.01	0.20	0.00									3		
4	2.40	1.42	1.48	0.44	0.85	0.12	0.62	0.05	0.38	0.02	0.26	0.01									4		
5	3.00	2.15	1.85	0.66	1.07	0.18	0.78	0.08	0.47	0.02	0.33	0.01	0.21	0.00							5		
6	3.60	3.02	2.22	0.93	1.28	0.25	0.94	0.12	0.57	0.03	0.40	0.01	0.26	0.01							6		
7	4.20	4.01	2.59	1.24	1.49	0.33	1.10	0.15	0.66	0.05	0.46	0.02	0.30	0.01							7		
8	4.80	5.14	2.96	1.59	1.71	0.42	1.25	0.20	0.76	0.06	0.53	0.02	0.34	0.01							8		
9	5.40	6.39	3.33	1.97	1.92	0.52	1.41	0.25	0.85	0.07	0.60	0.03	0.39	0.01							9		
10	6.00	7.77	3.70	2.40	2.14	0.63	1.57	0.30	0.95	0.09	0.66	0.04	0.43	0.01							10		
11	6.60	9.27	4.07	2.86	2.35	0.75	1.73	0.36	1.05	0.11	0.73	0.04	0.47	0.02							11		
12	7.21	10.89	4.44	3.36	2.57	0.89	1.88	0.42	1.14	0.12	0.80	0.05	0.52	0.02	0.30	0.00					12		
14	8.41	14.48	5.19	4.47	2.99	1.18	2.20	0.56	1.33	0.17	0.93	0.07	0.60	0.02	0.35	0.01					14		
16	9.61	18.55	5.93	5.73	3.42	1.51	2.51	0.71	1.52	0.21	1.07	0.09	0.69	0.03	0.40	0.01					16		
18	10.81	23.07	6.67	7.13	3.85	1.88	2.83	0.89	1.71	0.26	1.20	0.11	0.78	0.04	0.45	0.01					18		
20	12.01	28.04	7.41	8.66	4.28	2.28	3.14	1.08	1.90	0.32	1.33	0.13	0.86	0.05	0.50	0.01					20		
22	13.21	33.45	8.15	10.33	4.71	2.72	3.46	1.29	2.10	0.38	1.47	0.16	0.95	0.06	0.55	0.01					22		
24	14.42	39.30	8.89	12.14	5.14	3.20	3.77	1.51	2.29	0.45	1.60	0.19	1.04	0.07	0.60	0.02					24		
26	15.62	45.58	9.64	14.08	5.57	3.71	4.09	1.75	2.48	0.52	1.74	0.22	1.12	0.08	0.65	0.02					26		
28	16.82	52.28	10.38	16.15	5.99	4.25	4.40	2.01	2.67	0.60	1.87	0.25	1.21	0.09	0.70	0.02					28		
30	18.02	59.41	11.12	18.35	6.42	4.83	4.72	2.28	2.86	0.68	2.00	0.29	1.30	0.10	0.75	0.03					30		
35			12.97	24.42	7.49	6.43	5.50	3.04	3.34	0.90	2.34	0.38	1.51	0.13	0.88	0.04	0.38	0.00			35		
40			14.83	31.27	8.56	8.23	6.29	3.89	3.81	1.15	2.67	0.49	1.73	0.17	1.00	0.04	0.44	0.01			40		
45			16.68	38.89	9.64	10.24	7.08	4.84	4.29	1.43	3.01	0.60	1.95	0.21	1.13	0.06	0.49	0.01			45		
50			18.53	47.27	10.71	12.45	7.87	5.88	4.77	1.74	3.34	0.73	2.16	0.26	1.25	0.07	0.55	0.01			50		
55					11.78	14.85	8.65	7.01	5.25	2.08	3.68	0.88	2.38	0.30	1.38	0.08	0.61	0.01			55		
60					12.85	17.45	9.44	8.24	5.72	2.44	4.01	1.03	2.60	0.36	1.51	0.10	0.66	0.01			60		
65					13.92	20.23	10.23	9.56	6.20	2.83	4.35	1.19	2.81	0.41	1.63	0.11	0.72	0.02			65		
70					14.99	23.21	11.01	10.96	6.68	3.25	4.68	1.37	3.03	0.48	1.76	0.13	0.77	0.02	0.44	0.00	70		
75					16.06	26.37	11.80	12.46	7.16	3.69	5.01	1.56	3.25	0.54	1.88	0.14	0.83	0.02	0.48	0.01	75		
80					17.13	29.72	12.59	14.04	7.63	4.16	5.35	1.75	3.46	0.61	2.01	0.16	0.88	0.02	0.51	0.01	80		
85					18.21	33.26	13.37	15.71	8.11	4.66	5.68	1.96	3.68	0.68	2.13	0.18	0.94	0.02	0.54	0.01	85		
90					19.28	36.97	14.16	17.46	8.59	5.18	6.02	2.18	3.90	0.76	2.26	0.20	0.99	0.03	0.57	0.01	90		
95							14.95	19.30	9.07	5.72	6.35	2.41	4.11	0.84	2.39	0.22	1.05	0.03	0.60	0.01	95		
100							15.74	21.22	9.54	6.29	6.69	2.65	4.33	0.92	2.51	0.25	1.10	0.03	0.64	0.01	100		
110							17.31	25.32	10.50	7.51	7.36	3.16	4.76	1.10	2.76	0.29	1.22	0.04	0.70	0.01	110		
120							18.88	29.75	11.45	8.82	8.03	3.72	5.20	1.29	3.02	0.34	1.33	0.05	0.76	0.01	120		
130								12.41	10.23	8.70	4.31	5.63	1.50	3.27	0.40	1.44	0.05	0.83	0.01		130		
140								13.36	11.74	9.37	4.94	6.06	1.72	3.52	0.46	1.55	0.06	0.89	0.02		140		
150								14.32	13.33	10.03	5.62	6.50	1.95	3.77	0.52	1.66	0.07	0.96	0.02		150		
160								15.27	15.03	10.70	6.33	6.93	2.20	4.02	0.59	1.77	0.08	1.02	0.02		160		
170								16.23	16.81	11.37	7.08	7.36	2.46	4.27	0.66	1.88	0.09	1.09	0.02		170		
180								17.18	18.69	12.04	7.87	7.80	2.74	4.53	0.73	1.99	0.10	1.15	0.03		180		
190								18.14	20.66	12.71	8.70	8.23	3.02	4.78	0.81	2.10	0.11	1.21	0.03		190		
200								19.09	22.72	13.38	9.57	8.66	3.33	5.03	0.89	2.21	0.12	1.28	0.03		200		
225													15.05	11.90	9.75	4.14	5.66	1.10	2.49	0.15	1.44	0.04	225
250													16.73	14.47	10.83	5.03	6.29	1.34	2.77	0.18	1.60	0.05	250
275													18.40	17.26	11.92	6.00	6.92	1.60	3.05	0.22	1.76	0.06	275
300															13.00	7.05	7.55	1.88	3.32	0.26	1.92	0.07	300
325															14.08	8.17	8.18	2.18	3.60	0.30	2.08	0.08	325
350															15.17	9.38	8.81	2.50	3.88	0.34	2.24	0.09	350
375															16.25	10.65	9.43	2.84	4.15	0.39	2.40	0.10	375
400															17.33	12.01	10.06	3.20	4.43	0.44	2.56	0.11	400
425															18.42	13.43	10.69	3.58	4.71	0.49	2.72	0.13	425
450															19.50	14.93	11.32	3.98	4.99	0.54	2.88	0.14	450
475																	11.95	4.40	5.26	0.60	3.04	0.16	475
500																	12.58	4.84	5.54	0.66	3.20	0.17	500
550																	13.84	5.77	6.10	0.79	3.52	0.21	550
600																	15.10	6.78	6.65	0.92	3.84	0.24	600
650																	16.36	7.86	7.20	1.07	4.16	0.28	650
700																	17.62	9.02	7.76	1.23	4.48	0.32	700
750																	18.87	10.25	8.31	1.40	4.80	0.37	750
800																		8.87	1.57	5.12	0.41	800	
850																		9.42	1.76	5.44	0.46	850	
900																		9.98	1.96	5.76	0.51	900	
950																		10.53	2.16	6.08	0.57	950	
1000																		11.09	2.38	6.40	0.63	1000	
1050																		11.64	2.60	6.72	0.68	1050	
1100																		12.20	2.84	7.04	0.75	1100	
1150																		12.75	3.08	7.36	0.81	1150	
1200																		13.31	3.33	7.68	0.88	1200	
1250																		13.86	3.60	8.00	0.95	1250	

Numbers

3-SF SOCKET FUSION KIT 3:36
 3TN NOZZLE 8:22, 8:23
 4 WAY KEY 13:12
 6-IN-1 MULTI-TOOL 13:14
 100 SERIES CONTROL VALVES 9:35
 205 SERIES CONTROL VALVES 9:36
 254 / 264 SERIES CONTROL VALVES 9:38
 485 MICRO STROBE LIGHT 8:48
 490 MICRO STROBE LIGHT 8:48
 700 SERIES CONTROL VALVES 9:35
 801 MINI I STROBE LIGHT 8:48
 824 MULTI PULSE STROBE LIGHT 8:48
 1800 SERIES TURF SPRAYS 9:5
 2045A MAXI-PAW™ 9:18
 2500 SERIES CONTROL VALVES 9:36
 3000 SERIES PIVOT PRODUCTS 8:22, 8:23, 8:24, 8:25
 A3000 ACCELERATOR 8:22
 ACCESSORIES 8:25
 BLUE TOP REGULATORS 8:25
 D3000 SPRAYHEAD 8:23
 DRAG HOSE ADAPTER 8:23
 DROP WEIGHT 8:13, 8:25
 NOZZLE CLIPS 8:25
 O3000 ORBITOR 8:23
 PC-D3000 PART CIRCLE SPRAYHEAD 8:24
 PC-R3000 PART CIRCLE ROTATOR 8:24
 PC-S3000 PART CIRCLE SPINNER 8:24
 R3000 ROTATOR 8:22
 S3000 SPINNER 8:22
 SPRAYHEAD 8:23
 SQUARE THREAD X HOSE BARB ADAPTER 8:25
 T3000 TRASHBUSTER SPRAYHEAD 8:23
 3500 SERIES ROTOR 9:17
 5000 PLUS SERIES 9:17
 5000 SERIES ROTOR 9:17
 5022 FULL CIRCLE 7:6
 5500 SERIES ROTOR 9:17
 6504 SERIES FALCON® ROTOR 9:18
 8005 SERIES ROTOR 9:18
 19000 SERIES SCREEN FILTERS 11:17

A

A3000 ACCELERATOR 8:22
 ACCELERATOR 8:22
 ACTUATOR ROD 8:43
 ACTUATORS 2:39, 8:43
 ADAPTERS
 ADAPTERS, IPS 4:14
 AIR RELIEF VALVE, PIP 4:6
 BUNGIE 10:40
 CAM LEVER 3:20, 3:21, 3:22, 3:23, 3:24
 CAPS 6:6
 COMPRESSION, DRIP 10:28
 DISCHARGE 2:62, 2:63
 DISTRIBUTION THREADED 10:51
 FIRE HYDRANT 3:18
 FLANGED, AMRAD 7:17
 FLANGED, EPOXY IPS 4:40
 FLANGED, EPOXY PIP 4:49
 HDPE IPS FUSION 3:34
 HOSE BARB, POLYPROPYLENE 3:25
 HOSE BARB, STEEL 3:26
 HOSE THREAD & TRANSITION 3:18, 3:19, 10:50
 INLET 6:8
 INSERT 3:38
 OUTLET 8:8
 PIPE BARB, STEEL 3:45
 POLYMATE® 3:43
 POLYPROPYLENE 3:21, 3:25, 12:21
 POWER-LOC™ 10:30, 10:32, 10:33, 10:34
 PVC FABRICATED 4:11
 PVC IPS FABRICATED 4:15
 PVC PIP FABRICATED 4:6, 4:11
 PVC SCHEDULE 40 4:24, 4:26

PVC SCHEDULE 40 CLEAR 4:28
 PVC SCHEDULE 40 UV 4:27
 PVC SCHEDULE 80 4:31, 4:32
 SHRUB 9:12, 10:51
 START CONNECTORS 10:38
 SWIVEL 10:50
 TAPE-LOC® 10:35
 TECHLINE® 10:39
 TELESCOPING 7:18, 7:25
 TWIST-LOCK 10:38
 VINYL GROMMET 8:8
 ADHESIVE MARKING TAPE 13:23
 ADJUSTABLE WRENCH 13:14
 AGF MEDIA FILTER BATTERIES 11:18
 AG SPRINKLERS 6:9, 6:10, 6:11, 6:12, 6:13, 6:14, 6:15, 6:16, 6:17, 6:21, 6:22, 6:23, 6:24, 6:25, 6:26, 6:27, 6:28, 6:29, 6:30, 6:31, 6:32
 AIRCRAFT CABLE 8:8
 AIR RELEASES 2:15
 AIR RELIEF ADAPTER
 IPS 4:14
 PIP 4:6
 AIR & VACUUM RELIEF VALVES
 ALUMINUM 2:32, 2:33
 PLASTIC 2:31, 2:32
 AIR VALVES 2:15
 AIR & WATER HOSE 3:6
 AISLE MARKING TAPE 9:61, 13:23
 ALFAGOMMA®
 PETROLEUM SUCTION & DISCHARGE HOSE 3:14
 T253AA 150PSI SBR WATER DISCHARGE HOSE 3:7
 WATER SUCTION & DISCHARGE HOSE 3:14
 ALFALFA VALVES & HYDRANTS 5:52, 5:53
 ALIGNMENT WIRE & ACCESSORIES 8:46
 ALL THREAD ROD 13:9
 ALUMINUM
 AIR & VACUUM RELIEF VALVES 2:32, 2:33
 ALFALFA VALVES 5:52
 BAND & LATCH LATERAL LINE FITTINGS 5:30, 5:31
 BAND & LATCH MAINLINE FITTINGS 5:26, 5:27
 BAND & LATCH SOLID SET FITTINGS 5:32, 5:33
 CAM LEVER COUPLINGS 3:22
 CENTER INLET TEE 7:18, 7:25
 CHECK VALVE 2:48
 DEMOUNTABLE FLANGE ADAPTER 7:19
 FOOT VALVES 2:53
 GUN STAND 6:34
 HOLD BANDS 5:11, 7:21
 HOSE BARB FITTINGS 3:27, 3:28
 HYDRANTS 5:52, 5:53
 MANUAL FLUSHING END PLUG 7:18, 7:25
 PIPE 5:9
 QUADRUPLEX ALUMINUM CABLE 1:4
 RAKE 13:11
 RING LOCK - HIGH PRESSURE 5:19, 5:20, 5:21
 RING LOCK - LOW PRESSURE 5:17, 5:18
 RISERS, SPRINKLER 6:20
 SOCK CLIPS 5:8
 SWAGE SLEEVES 8:8, 13:5
 TELESCOPING ADAPTER 7:18, 7:25
 THREADED HALF COUPLER 2:84
 TOE NIPPLE 2:84
 TORQUE COUPLER 7:17, 7:19, 7:24
 TUBING 5:9
 TWIST LOCK FITTINGS 5:12
 VALVE OPENERS 5:43, 5:44
 VALVE STUB 5:49
 WELD-ON FITTINGS 2:83, 2:84
 ANCHOR 13:9
 ANGLE VALVE 9:36
 ANGUS HOSE 3:10, 3:11
 ANTI-EROSION SOCKS 5:8
 ANTI-SIPHON VALVE 9:48
 APOLLO™ DISC-KLEEN FILTERS 11:17
 APPLICATORS 4:37

APPLICATOR WEIGHTS 8:13
 AQUA BURST® 6:16, 9:26
 AQUADOCK™ 8:31
 AQUA-DROP FILTER 8:6, 11:4
 AQUA-LINE 10:7
 ARC SUPPRESSOR 8:46
 AREA CONVERSION FACTORS 14:10
 AREA FORMULA 14:12
 ARMORED PERIMETER GUIDANCE CABLE 1:7
 ASTRO FLASH® STROBE LIGHT 8:48
 ATMOSPHERIC VACUUM BREAKER 9:49
 ATRIUM GRATES 9:54
 AUTO-DRAIN 2:15
 AUTOMATIC
 DRAIN VALVES 9:57
 FILTERS 11:7, 11:16, 11:17, 11:18, 11:24, 11:25
 PURGE SYSTEMS 11:19, 11:28
 AUXILIARY CONTACT 1:27, 8:45

B

BACKFLOW PREVENTION
 CHAMPION® 9:48
 FEBCO® 9:48
 VACUUM BREAKER 9:48
 ZURN-WILKINS 9:49
 BACKFLUSH CONTROLLERS 11:19
 BACKPACK SPRAYER 13:20
 BAGS 13:12, 13:16
 BALL AND SOCKET FITTINGS 5:13, 5:14, 5:15, 5:16
 BALL PEEN HAMMER 13:18
 BALL VALVES
 BRASS 2:44
 COMPACT MOTORIZED 11:28
 COMPRESSION IPS HDPE 3:41
 COMPRESSION UNIVERSAL 3:42
 HOSE THREAD 10:49, 10:51
 PIVOT 8:6
 PLASTIC 2:45
 POLYPROPYLENE 2:45
 PVC 2:45
 STAINLESS STEEL 2:44
 BAND & LATCH
 ALUMINUM FITTINGS 2:84, 3:28
 ASSEMBLY, PARTS & ACCESSORIES 5:34
 BUTTERFLY LINE VALVE 2:42
 GATED PIPE COUPLERS 5:27
 HOSE BARBED FITTINGS GALV 3:29
 LATERAL LINE FITTINGS ALUMINUM 5:30, 5:31
 LATERAL LINE STEEL 5:35
 MAINLINE ALUMINUM 5:26, 5:27
 MAINLINE STEEL 5:35, 5:36, 5:37
 SOLID SET FITTINGS ALUMINUM 5:32, 5:33
 STEEL 5:35, 5:36, 5:37, 5:38, 5:39, 5:40
 VALVE OPENERS 5:41, 5:42, 5:43, 5:44
 BARBED DISTRIBUTION FITTINGS 10:51
 BARBED FITTINGS
 ALUMINUM 3:27, 3:28
 DRIP 10:39, 10:40
 PIVOT DROP HOSE 8:14
 SPIRAL TURF 9:30
 STEEL 3:29, 3:30
 BARBED SHUT-OFF VALVES 10:51
 BARE COPPER GROUND WIRE 1:8
 BARRICADE TAPE 9:61, 13:23
 BAR TOOLS 13:11, 13:18
 BASINS, DRAINAGE 9:54
 BATTERY POWERED CONTROLLERS 9:41, 9:43
 BAUER STYLE FITTINGS 5:13, 5:14, 5:15, 5:16
 BEARING ASSEMBLY
 BIG GUNS 6:25, 8:30
 IMPACTS 6:18, 6:19, 8:26
 BEE VALVE 2:45
 BELL REDUCERS
 MALLEABLE 2:68
 STAINLESS STEEL 2:76, 2:77

- BENT NOSE GARDEN VALVE 2:47
 BENT NOSE PLIERS 13:18
 BIC 1000 BERHAD CONTROLLER 10:48
 BIG GUN® 6:23, 6:24, 6:25, 6:23, 8:28
 BIG GUN ACCESSORIES 8:30
BLACK
 BUTT WELD FITTINGS 2:85
 GOE NIPPLES 2:71
 MALLEABLE FITTINGS 2:65, 2:66, 2:67, 2:68, 2:69, 2:70
 MERCHANT COUPLERS 2:71
 STANDARD WELD FITTINGS 2:86, 2:87, 2:88
 STARTER COUPLERS 2:89
 STEEL NIPPLES 2:71, 2:73
 TOE NIPPLES 2:71
 WELD-ON FITTINGS 2:85, 2:86, 2:87, 2:88, 2:89
BLEEDER ORIFICE / DRAIN VALVE 2:15
BLEEDER VALVES & FITTINGS 12:4
BLIND FLANGE
 CARBON STEEL 2:40
 PVC SCH 80 4:33
 STAINLESS STEEL 2:40, 2:79
BLIND TEE 9:53
BLOCKS 2:5
 POWER DISTRIBUTION 1:25
 TERMINAL 1:25
BLUE TOP REGULATORS 6:4, 8:25, 10:26
BOILER DRAIN 2:47
BOLTED
 CHECK VALVE 2:48
 CLEARVIEW CHECK VALVES 2:50
 CLEARVIEW COUPLINGS 2:60
 COUPLINGS 2:60, 2:61
 POLYPROPYLENE BALL VALVES 2:45
 REPAIR COUPLINGS 4:63, 4:64, 4:65, 4:66, 4:67
 SUCTION COUPLERS 2:82
BOLTED REPAIR COUPLINGS 4:63, 4:64, 4:65, 4:66, 4:67
BOLTED STARTER COUPLER 2:91
BOLT-ON
 CENTER LINE RISER 5:32
BOLTS
 CAP SCREW 13:6, 13:7
 CARRIAGE BOLTS 13:8
 HEX BOLT 13:7
 HEX CAP SCREW 13:6, 13:7
BOLT TITE
 CHEMIGATION VALVES 2:52
 FITTINGS 4:59, 4:60, 4:61, 4:62, 4:63, 4:64
 GASKET 4:61
 STARTER COUPLER 2:91
BOOM BACKS 8:9
BOOSTER PUMP 8:35
 END GUN BOOSTER PUMP 8:35
 WATER SUPPLY 7:13, 7:14, 7:15, 7:16
BOOT HOSE 3:7, 3:8, 8:49
BOX ENCLOSURES 1:24
BRAIDED SUBMERSIBLE SAFETY ROPE 2:17
BRASS / BRONZE
 ADAPTERS 2:17, 3:18, 3:19
 AG IMPACT SPRINKLERS 6:15, 6:16, 6:17
 AIR VALVES 2:15
 ANGLE VALVE 9:36
 BACKFLOW PREVENTION 9:48, 9:49
 BALL VALVE 2:44
 BEARING ASSEMBLY IMPACTS 6:18, 6:19, 9:26
 CHECK VALVES 2:10, 2:48
 CYCLE STOP VALVES 2:14
 DRAIN VALVE 2:15
 ELECTRIC VALVE 9:32
 FLOAT VALVES 2:59
 FOOT VALVE 2:53
 GATE VALVE 2:46
 GLOBE VALVE 9:34
 HOSE BIBBS 2:47
 HOSE COUPLINGS 3:18, 3:19
 HOSE NOZZLES 3:15
 IMPACT SPRINKLERS 6:15, 6:16, 6:17, 9:24, 9:25, 9:26
 NOZZLES, IMPACTS 6:18, 6:19
 PITLESS ADAPTERS 2:8
 PRESSURE REDUCING VALVE 9:47
 QUICK COUPLING VALVES 9:27
 RELIEF VALVES 2:15
 SERVICE SADDLE 2:81
 SOLENOID VALVES 9:32, 9:34
 SPINNERS 6:6
 SPRINKLERS & NOZZLES 6:15, 6:16, 6:17, 6:18, 6:19
 TANK CROSSES 2:11
 TURF IMPACT SPRINKLERS & NOZZLES 9:24, 9:25, 9:26
BRASS IMPACTS 8:26
BREWING SYSTEMS 12:13
BRICK RED LAYFLAT HOSE 3:10
BROOM 13:11
BROWN LANDSCAPE DRIPLINE 10:6
BRUSHAWAY FILTERS 11:5, 11:6
BS-4 BUTT FUSION KIT 3:36
BUBBLERS 9:15
BUG CAP 10:52
BUG GUN INSTALLATION TOOL 10:56
BULKHEAD FITTINGS
 POLYPROPYLENE 12:20
BUNGIE ADAPTER 10:40
BUNGIE TIE DOWNS 13:19
BUSHING
 MALLEABLE HEX 2:69
 PLASTIC PIPE THREAD 4:25, 4:32
 POLYPROPYLENE 12:19
 PVC SCH. 40 4:25
 PVC SCH. 40 CLEAR 4:28
 PVC SCH. 40 UVR 4:27
 PVC SCH. 80 4:32
 STAINLESS STEEL HEX 2:77, 2:78
BUSHMAN RAIN WATER HARVESTING 9:56
BUTTERFLY EXTENSIONS 2:38
BUTTERFLY LINE VALVES 2:42, 2:43, 5:6, 5:18
BUTTERFLY VALVE ACCESSORIES 2:39
BUTTERFLY VALVES 2:36, 2:37, 2:38
BUTT SPLICE 1:10
BUTT WELD FITTINGS 2:85
- C**
- CABLE**
 18 AWG MULTI CONDUCTOR 1:9
 ARMORED PERIMETER GUIDANCE CABLE 1:7
 BARE COPPER GROUND 1:8
 CABLE IN CONDUIT 1:4
 COPPER TRAY CABLE 1:5
 KILL WIRE 1:5
 LANDSCAPE LIGHTING 1:9
 LOW VOLTAGE LANDSCAPE LIGHTING CABLE 1:9
 MOTOR DROP 1:6
 PIVOT SYSTEM CABLE 1:6, 1:7
 PROOF POSITIVE® SPAN CABLE 1:6
 QUADRUPLX ALUMINUM 1:4
 REMOTE PANEL TRAY CABLE 1:7
 SHIELDED BURIED SIGNAL CABLE 1:7
 SHIELDED MOTOR DROP 1:6
 SINGLE CONDUCTOR 1:9
 SOOW CABLE 1:5
 SPAN CABLE 1:6
 SUBMERSIBLE PUMP CABLE 1:8
 UNDERGROUND 1:9
CABLE GUARD 2:17
CABLE IN CONDUIT 1:4
CABLE SAW 4:39
CABLE TIES 1:14
CAM LEVER FITTINGS 3:20, 3:21, 3:22, 3:23, 3:24, 12:18
 ALUMINUM QUICK-ACTING FITTINGS 3:22
 HOSE THREAD 3:20
 POLYPROPYLENE 3:21
 POLYPROPYLENE QUICK-ACTING FITTINGS 12:18
 STAINLESS STEELTYPE - 304 3:23
 STAINLESS STEEL TYPE - 316 3:24
CANS - GLUE & PRIMER 4:37
CAP
 BUTT WELD 2:85
 CAM LEVER 3:21, 3:22, 3:23, 3:24
 DRAINAGE 9:53
 EPOXY COATED IPS 4:48
 EPOXY COATED PIP 4:55
 EPOXY RISER W/STUB VALVE IPS 4:46
 EPOXY RISER W/STUB VALVE PIP 4:54
 HOSE THREAD 10:50
 HOSE THREAD BRASS 3:18
 IPS RISER W/STUB VALVE 4:46
 MALLEABLE BLACK & GALV. 2:70
 PIP RISER W/STUB VALVE 4:54
 POLYPROPYLENE 12:20
 PVC IPS FABRICATED 4:14
 PVC PIP FABRICATED 4:6
 PVC SCH. 40 4:25
 PVC SCH. 40 CLEAR 4:28
 PVC SCH. 80 4:32
 PVC SURFACE 4:6
 STAINLESS STEEL 2:78
CAPROCK IRRIGATION SHOVEL 13:10
CAP SCREW 13:6, 13:7
CARBON STEEL FLANGES 2:40
CARRIAGE BOLTS 13:8
CARTRIDGE FILTERS 2:18, 2:19, 11:20, 11:21
CARTS 6:34
CAST IRON
 BOLTED COUPLING 4:67
 BOLTED STEEL 2:48
 GATE VALVE 2:46
 THREADED FLANGE 2:41
 WAFER CHECK VALVE 2:48
CEMENTS - PVC 4:36, 4:37
CENTER DRIVES & MOTORS 8:38, 8:39, 8:40
CENTER INLET TEE 7:18, 7:25
CENTER PIVOT ACCESSORIES 8:4-8:55
CENTER PUNCH CLAMPS 3:48
C-FACE CENTER DRIVE 8:39
CHAIN 13:4
 TRANSPORT CHAIN 13:4
CHAIN - ELECTRO-GALVANIZED PROOF COIL 13:4
CHAIN, SIDE ROLL 7:26, 7:27
CHECK VALVES 12:8
 ALUMINUM SWING 2:48
 BRASS SPRING 2:10
 BRASS SWING 2:48
 CHEMIGATION 2:51, 2:52, 12:8
 CLEARVIEW 2:50, 2:51
 COMPRESSION 2:48
 DRAIN CHECK 6:4, 6:5
 FLANGED 2:51
 GALVANIZED 2:51, 2:52
 PVC 2:49
 SPRING 2:10
 SPRING CHECK VALVES 2:10
 STAINLESS STEEL SWING 2:48
 WAFER, CAST IRON 2:48
 WELD-ON 2:51
CHEMIGATION SYSTEMS 12:5, 12:7, 12:10, 12:11
 AGRI-INJECT 12:7
 INJECT-O-METER 12:10, 12:11
 WALCHEM 12:15
CHEMIGATION VALVES 2:51
CHEVRON GASKET FOR VOE 5:45, 5:46
CIRCLE LOCK FITTINGS 5:17, 5:18, 5:19, 5:20, 5:21, 5:22, 5:23, 5:24, 5:25
CIRCLE STRETCHER 8:9
CIRCUMFERENCE FORMULA 14:12
CLAMP LOCK RING VOE 5:45, 5:46
CLAMP-ON QUICK LATCH COUPLER 5:30
CLAMPS 3:45, 3:46, 3:47, 3:48, 3:49, 8:15, 10:57
 CENTER PUNCH 3:48
 CIRCLE LOCK 5:21

INTRO | 1. ELECTRICAL | 2. PUMP ACC. | 3. HOSE, PE PIPE & ACC. | 4. IPS, PIP PIPE & ACC. | 5. SURFACE | 6. SPRINKLERS | 7. TRAVELER & WHEEL MOVE | 8. PIVOT | 9. TURF | 10. LOW VOLUME | 11. FILTERS | 12. INJECTION | 13. HARDWARE | INDEX

- CRIMP 3:45, 8:15, 10:57
- DOUBLE BOLT 3:48
- DRAW BANDS 3:49
- DUCTILE IRON DOUBLE BOLT CLAMPS 3:48
- ELECTROFUSION PIPE CLAMP SET 3:36
- GEAR 3:46, 8:15
- INVERTED 7:20
- IPS PATCH 4:69
- MAINLINE PIPE CLAMP 8:8
- OETIKER 3:45
- OUTLET ADAPTERS 8:8
- PATCH 4:69, 4:70, 4:71
- PATCH CLAMPS 3:50, 3:51
- PATCH O.D. 4:70, 4:71
- PINCH 3:45, 8:15, 10:57
- PIPE REPAIR 4:68
- REPAIR 4:68, 4:69, 4:70, 4:71
- RING LOCK 5:21
- T-BOLT 3:47, 8:49
- TORQUE 7:18, 7:24
- WIRE 3:45
- WORM GEAR HOSE CLAMPS 3:46
- CLAMP TOOLS 3:45**
- CLAW HAMMER 13:18
- CLEANER - PVC 4:37
- CLEARBRAID® CLEAR REINFORCED HOSE 3:6
- CLEAR PVC SCHEDULE 40 PIPE & FITTINGS 4:28
- CLEARVIEW**
- CHECK VALVES 2:50, 2:51
- COUPLINGS 2:60
- FILTERS 11:22, 11:23
- CLEATS - SIDE ROLL 7:23
- CLEVIS GRAB HOOK 13:5
- CLIPS - SOCK 5:8
- COBRA CONNECTOR™ 9:29
- COILS 8:34
- COLD GALVANIZE COATING SPRAY 13:22
- COLLAR LEAK REPAIR CLAMP 4:68
- COLLECTOR RING 8:46
- COMBINATION RATCHETING WRENCH SET 13:14
- COMMERCIAL / INDUSTRIAL HOSE 3:4
- COMPACT MOTORIZED BALL VALVE 11:28
- COMPOST TEA 9:57
- COMPOST TEA EXTRACTOR & BREWING SYSTEMS 12:13
- COMPRESSION**
- CHECK VALVE 2:48
- DRIP FITTINGS 10:27, 10:28, 10:29
- GASKET IPS 4:48
- GASKET PIP 4:55
- IPS HDPE FITTINGS 3:39, 3:40, 3:41
- IPS PVC FITTINGS 4:26
- UNIVERSAL FITTINGS 3:41, 3:42
- COMPRESSION FITTINGS 10:27, 10:28, 10:29
- CON-AG SUCTION HOSE 3:14
- CONCENTRIC CONES 2:86
- CONCENTRIC REDUCER
- ALUMINUM 2:84
- BUTT WELD 2:85
- IPS HDPE 3:33
- STEEL 2:86
- CONCRETE COME-A-LONG 13:12
- CONDUIT 1:16**
- EMT CONDUIT 1:17
- PVC SCH. 40 CONDUIT & FITTINGS 1:16
- CONES**
- BLACK WELD-ON 2:86
- CONE SCREENS 11:29
- CONNECTOR FITTINGS 10:39
- CONNECTORS**
- ELECTRICAL 1:10
- SOCKET - 8 PIN & 11 PIN 1:26, 8:44
- CONTACT BLOCK 2:5
- CONTACT KIT 2:7
- CONTACTORS 1:27, 8:45
- CONTINUOUS ACTING AIR VENT 2:32
- CONTROL GATES 5:7, 5:56
- NAVIGATOR 5:56
- CONTROLLERS (BY APPLICATION)**
- BACKFLUSH CONTROLLERS 11:19
- LOW VOLUME 10:47, 10:48
- PH / ORP 12:15
- SURGE 5:10, 5:11
- TURF 9:42, 9:43, 9:44, 9:45
- CONTROLLERS (BY BRAND)**
- BERMAD CONTROLLERS 10:48
- EDSTROM CONTROLLERS 10:47
- HUNTER® 9:42, 9:43
- IRRITROL® 9:45
- NETAFIM™ 10:48, 11:19
- P&R SURGE 5:10, 5:11
- RAIN BIRD® 9:39, 9:40, 9:41
- SUPERIOR 9:44, 10:48
- TORO® 9:44
- TORO® AG CONTROLLERS 10:47
- WALCHEM WPH400 12:15
- CONTROL VALVES 2:54, 2:55, 8:32, 8:33, 10:42, 10:43, 10:44, 10:45, 10:46
- AQUAMATIC END GUN CONTROL VALVE 8:33
- BERMAD CONTROL VALVES 10:42
- CHAMPION® 9:36
- CONTROL VALVE ACCESSORIES 8:34
- HUNTER® 9:33, 9:34
- IRRITROL® 9:35, 9:36
- JOHN DEERE™ 9:36
- NELSON 800 SERIES 2:54, 8:32, 10:44
- NETAFIM™ CONTROL VALVES 2:55, 8:32, 10:45
- RAIN BIRD® CONTROL VALVES 9:31, 9:32, 10:43
- TORO® 9:37, 9:38, 10:43
- XCAD AUTOMATIC CONTROL VALVES 2:56, 8:33, 10:46
- CONTROL ZONE KIT ASSEMBLY 10:43
- CONVERSION FACTORS 14:10, 14:11, 14:12
- COOLING COILS 2:30
- COOLING CONTROLLER 10:47
- COOL SENSE 10:47
- COOLSHOT™ HOSE NOZZLES 3:15
- COPPER**
- TRAY CABLE 1:5
- WIRE 1:5, 1:8
- COUPLERS, DRIVELINE 8:36**
- COUPLINGS**
- ALUMINUM HALF 2:84
- ALUMINUM HALF COUPLER 8:15
- BAND & LATCH LATERAL LINE - ALUM. 5:28, 5:30
- BAND & LATCH LATERAL LINE - STEEL 5:35
- BAND & LATCH MAINLINE - ALUM. 5:26, 5:27
- BAND & LATCH MAINLINE - STEEL 5:35, 5:36
- BAND & LATCH QUICK LATCH 5:30
- BAND & LATCH SOLID SET 5:32, 5:33
- BOLTED 2:60, 2:61, 4:63, 4:64, 4:65, 4:66, 4:67
- BOLTED RISER 4:60
- CAM LEVER 3:20, 3:21, 3:22, 3:23, 3:24
- CAST IRON - BOLTED 4:67
- CLEARVIEW 2:60
- COMPRESSION - DRIP 10:27, 10:28
- COMPRESSION - HDPE 3:39
- COMPRESSION - PVC IPS 4:26
- COMPRESSION - UNIVERSAL 3:41
- DISTRIBUTION, BARBED 10:51
- DRAINAGE 9:53
- DRESSER STYLE 2:60
- DRIVELINE 8:36
- DROP COUPLING 2:8, 2:71
- ELECTROFUSION 3:34
- EXPANSION - PVC 4:26
- FLEXIBLE RUBBER PIPE 4:71
- GASKETED 4:11, 4:12, 4:17, 4:18
- GROOVED 4:31, 4:33
- HOSE BARBED - ALUM. 3:27, 3:28
- HOSE BARBED - POLYPROPYLENE 12:21
- HOSE BARB - STEEL 3:26, 3:30
- INSERT 3:38, 10:39, 10:40
- LATERAL 5:28, 5:30, 5:35
- MAINLINE PRESS-ON 5:19, 5:23, 5:26, 5:27, 5:36
- MALLEABLE 2:67
- MERCHANT 2:71
- MERCHANT COUPLER 8:15
- PIPE BARB STEEL 3:45
- PLASTIC PIPE THREAD 4:24, 4:31, 8:14
- POLYMATE® 3:43
- POLYPROPYLENE 12:19
- POSITIVE LOCK 5:33
- POWER-LOC™ 10:30, 10:31, 10:32, 10:33, 10:34
- PVC IPS FABRICATED 4:14, 4:17, 4:18
- PVC PIP FABRICATED 4:6, 4:8, 4:11, 4:12
- PVC PIP UV RESISTANT 4:10
- PVC SCH. 40 4:24
- PVC SCH. 40 - CLEAR 4:28
- PVC SCH. 40 - UVR 4:27
- PVC SCH. 80 4:31, 4:33
- PVC SURFACE 5:6
- REPAIR EPOXY IPS 4:40
- REPAIR EPOXY PIP 4:49
- REPAIR PVC IPS 4:18
- REPAIR PVC PIP 4:12
- RING LOCK 5:17, 5:19, 5:22, 5:23
- RING LOCK - ALUM. HP 5:19
- RING LOCK - ALUM. LP 5:17
- RING LOCK - STEEL 2:89, 2:90
- RUBBER WITH STAINLESS STEEL BANDS 4:71
- SIDE ROLL 7:17, 7:19, 7:24
- STAINLESS STEEL FULL 2:76
- STAINLESS STEEL HALF 2:75
- STARTER 2:89, 2:90
- STARTER COUPLERS 2:89, 2:90, 2:91
- SUCTION 2:82
- TAPE-LOC® DRIP 10:35
- TRANSITIONAL 4:67
- TWIST-LOCK 5:12, 10:38
- WEDGE-TITE® 4:62, 4:63, 4:64
- WELD-ON 2:88, 2:89, 2:90, 2:91
- WHEEL MOVE 7:17, 7:19, 7:24
- COVER, WHEEL MOVE 7:17
- COW WASH ROTATOR 6:12
- CRIMING TOOLS 1:15
- CRIMP CLAMPS & TOOLS 3:45, 8:15, 10:57
- CROSS**
- ALUMINUM LOW PRESSURE 5:17
- BOLT TITE 4:61
- COMPRESSION DRIP 10:29
- FLANGED 2:64
- HOSE BARBED - ALUM. 3:28
- INSERT 3:38
- IPS EPOXY COATED 4:40
- MALLEABLE 2:67
- PIP EPOXY COATED 4:49
- POLYPROPYLENE 12:19
- PVC IPS FABRICATED 4:14, 4:17
- PVC PIP FABRICATED 4:6, 4:7, 4:11
- PVC SCH. 40 4:23
- PVC SCH. 80 4:31
- RING LOCK 5:17
- STAINLESS STEEL 2:75
- TANK 2:11
- CRUSHED GRANITE 11:28
- CUT-OFF NIPPLE 9:29
- CUT-OFF RISER EXTENSION 9:29
- CUTTING TOOLS**
- KEYHOLE SAW 13:16
- KNIVES 13:17
- PIPE & HOSE CUTTERS 4:39, 10:57
- SAWS 4:39
- UTILITY KNIFE 13:16
- C-X COUPLER 8:36
- CYCLE STOP VALVES 2:14
- CYCLONE SAND SEPARATOR 11:26

D

- D10 SPRAY 6:8
- D50 ROTORS 9:22
- D70 ROTORS 9:22

D3000 SPRAYHEAD 8:23
 DAM GATE™ 5:7
 DAUBER APPLICATOR 4:37
 DDCWP SERIES CONTROLLERS 9:44
 DEBURRING TOOL 4:39
 DECIMAL CONVERSION 14:12
 DEEP PUNCH COUPLINGS 2:89, 2:90
 DEEP SOCKET COUPLING - PVC 4:24
 DEFINITE PURPOSE CONTACTORS 1:27, 8:45
 DEMOUNTABLE FLANGE ADAPTER 7:19, 7:24
 DETACHABLE BAND & LATCH 5:26, 5:28, 5:29
 DETECTABLE UNDERGROUND WARNING TAPE 9:61, 13:23
 DIAGNOSTIC EQUIPMENT 1:33
 DIAGONAL CUTTING PLIERS 13:15
 DIAPHRAGM 2:56, 10:46
 DIAPHRAGM PUMP 2:20
 DIGGING TOOLS 13:10, 13:11
 CAPROCK IRRIGATION SHOVEL 13:10
 DRAIN SPADE 13:10
 POST HOLE DIGGER 13:10
 RAILROAD PICK 13:11
 ROUND POINT SHOVEL 13:10
 SCOOP SHOVEL 13:10
 SQUARE POINT SHOVEL 13:10
 TRENCH SHOVEL 13:10
 DIGITAL METER 10:54
 DIGITAL PHASE CONVERTER 1:20
 DIRECT BURIAL
 CABLE 1:4, 1:6, 1:7, 1:9
 CONNECTOR 1:10
 DISC
 VALVE STUB 5:50, 5:51
 WELDING 2:88
 DISC FILTERS 11:5, 11:6, 11:15, 11:16, 11:17
 DISCHARGE ADAPTERS
 BAND & LATCH ALUMINUM 2:62, 5:28
 BAND & LATCH GALV. 5:40
 BAND & LATCH GALVANIZED 2:62
 BOLT TITE EPOXY IPS & PIP 4:59
 BRASS 3:18, 3:19
 FLANGED 2:62, 2:63
 FLANGED IPS EPOXY 4:40
 FLANGED PIP EPOXY 4:49
 PITLESS 2:8
 RING LOCK 2:62
 ROPE 2:17
 SILCOCK 2:16
 SUCTION 2:82
 THREADED 2:62
 TWIST LOCK 2:63, 5:12
 DISCHARGE HOSE 3:5, 3:6, 3:7, 3:8, 3:9, 3:10, 3:11, 3:12, 3:13, 3:14
 DISC-KLEEN FILTER 11:17
 DISC-KLEEN FILTER BATTERIES 11:16
 DISCONNECT HUB 1:17
 DISCONNECTS 1:22, 2:6
 DISTRIBUTING GATE 5:55
 DISTRIBUTION FITTINGS 10:51
 DOG LEG 2:92
 DOUBLE
 BOLT CLAMP 3:48
 CHECK ASSEMBLY 9:48, 9:49
 LIP HOLE PLUGS 5:4
 DOWNSPOUT ADAPTER - DRAINAGE 9:53
 DPE COMPRESSION FITTINGS 3:40
 DRAG
 BULLET 8:12
 HOSE 8:12
 HOSE ADAPTER 8:23, 8:25
 HOSE ADAPTER I-WOB 8:18
 HOSE ADAPTER UP3™ LDN 8:17
 SOCKS 8:12
 DRAINAGE PIPE & FITTINGS 9:53, 9:54
 DRAIN BASINS & GRATES 9:54
 DRAIN CHECK VALVES 6:4, 6:5
 DRAINS 8:6

MUSHROOM PIVOT DRAIN 8:6
 ZAMAC POPPET DRAIN 8:6
 DRAIN SPADE 13:10
 DRAIN VALVES 9:57
 AIR 2:15
 CENTER PIVOT 8:6
 CHEMIGATION 2:52
 FLAPPER 7:20
 MUSHROOM 7:20, 8:6
 TURF - AUTOMATIC 9:57
 WHEEL MOVE 7:20
 DRAW BANDS 3:49
 DRESSER STYLE COUPLINGS 2:60, 2:61, 4:63, 4:64, 4:65, 4:66, 4:67
 DRILL BIT 8:8, 10:57
 DRILL TAP AND HOLE SAW KITS 13:14
 DRIP FITTINGS
 COMPRESSION 10:27, 10:28, 10:29
 CONNECTOR FITTINGS & GROMMETS 10:40
 INSERT FITTINGS 10:39, 10:40
 OUTLET ADAPTERS 10:40
 POWER-LOC™ 10:30, 10:31, 10:32, 10:33, 10:34
 TAPE-LOC® 10:35, 10:36, 10:37
 TWIST-LOCK 10:38
 DRIP IRRIGATION 10:2-10:57
 DRIPLINE FITTINGS 10:39
 DRIP MATE® 10:12
 DRIP OIL SYSTEM 2:22
 DRIP TAPE 10:8, 10:9
 EURODRIP® SEAMLESS 10:9
 NETAFIM™ STREAMLINE THINWALL 10:8
 NETAFIM™ TYPHOON THINWALL 10:8
 DRIP TAPE KIT 10:12
 DRIP TUBING 10:4, 10:5, 10:6, 10:7
 BOWSMITH 10:4, 10:6
 JAIN® 10:4, 10:7
 MICRO TUBING 10:5, 10:7
 NETAFIM™ 10:4, 10:5
 RAIN BIRD® 10:6
 DRIVELINE 8:35
 DRIVELINE COUPLERS 8:36
 DRIVE TRAIN COMPONENTS 8:35, 8:36, 8:37, 8:38, 8:39, 8:40
 DROP
 CLAMPS & TOOLS 8:15
 FILTERS 8:6
 FITTINGS 8:14, 8:15
 GALVANIZED 8:11
 HOSE 8:11, 8:12
 HOSE SAVER 8:11
 PIPE 2:8
 POLYDROP 8:11
 PVC 8:11
 VALVES 8:6
 WEIGHTS 8:13
 DROP FILTERS 8:6, 11:4
 DROP-LOCK / DRAGLINE 5:32
 DROP PIPE 2:8
 DROPS 8:11
 HOSE EXTENSIONS 8:11
 HOSE SAVER 8:11
 DROP WEIGHTS 8:13, 8:25
 3000 SERIES DROP WEIGHT 8:13
 APPLICATOR WEIGHTS 8:13
 ONE WEIGHT 8:13
 POLYWEIGHTS 8:13
 POLYWEIGHTS 8:13
 SCH. 40 GALVANIZED STEEL WEIGHT 8:13
 DRY PRESSURE GAUGE 2:15
 DUAL CHECK ASSEMBLY 9:49
 DUCTILE IRON DOUBLE BOLT CLAMPS 3:48
 DUCT TAPE 1:14
 DUST CAP
 POLYPROPYLENE 12:18
 DUST PLUG
 POLYPROPYLENE 12:18
 DV SERIES CONTROL VALVES 9:31

E

E2 AND E4 ORIFICE EMITTERS 10:11
 E-2" TAKE APART EMITTERS 10:11
 ECCENTRIC REDUCER
 ALUMINUM 2:84
 BUTT WELD 2:85
 STANDARD BLACK STEEL 2:86
 ECONOMY HAND TOOLS 13:18
 EDSTROM COOLING CONTROLLER 10:47
 ELBOW / ELL
 BAND & LATCH - GALV. 5:38
 BAND & LATCH LATERAL LINE - ALUM. 5:29, 5:30
 BARBED DISTRIBUTION 10:51
 BAUER STYLE 5:14
 BOLT TITE - IPS & PIP 4:59
 BUTT WELD 2:85
 COMPRESSION - DRIP 10:29
 DRAINAGE 9:53
 ELECTROFUSION 3:34
 EPOXY IPS GASKETED 4:41
 EPOXY PIP GASKETED 4:50
 FLANGED 2:64
 HDPE IPS COMPRESSION 3:40
 HDPE IPS FUSION 3:33
 HOSE BARB - ALUMINUM 3:27
 HOSE BARB - POLYPROPYLENE 3:25
 INSERT 10:39, 10:40
 IPS EPOXY COATED 4:41
 MALLEABLE 2:65, 2:66, 2:67
 PIP EPOXY COATED 4:50
 POLYPROPYLENE 12:19
 POWER-LOC™ 10:31
 PVC IPS FABRICATED 4:14, 4:15, 4:18
 PVC IPS FABRICATED GASKETED 4:18
 PVC PIP FABRICATED 4:7, 4:11, 4:12
 PVC PIP UV RESISTANT 4:10
 PVC SCH. 40 4:22, 4:23
 PVC SCH. 40 CLEAR 4:28
 PVC SCH. 40 UVR 4:27
 PVC SCH. 80 4:29, 4:30, 4:31
 RING LOCK ALUM. - HP 5:21
 RING LOCK ALUM. - LP 5:18
 RING LOCK GALV. 5:24
 RISER SIDE ROLL 7:21
 STAINLESS STEEL 2:74, 2:75
 STREET ELL - HDPE 4:22
 STREET ELL - MALLEABLE 2:66
 STREET ELL - SCH. 40 4:22, 4:23
 STREET ELL - SCH. 40 CLEAR 4:28
 STREET ELL, SCH. 40 UV 4:27
 STREET ELL, SCH. 80 4:30
 STREET ELL - STAINLESS STEEL 2:75
 SUCTION 2:82
 SURFACE, GALVANIZED 5:24, 5:38
 TAPE-LOC® 10:36
 TWIST LOCK 5:12
 VALVE OPENING 5:41, 5:42, 5:43, 5:44
 WELD-ON - ALUMINUM 2:83
 WELD-ON - STEEL 2:87
 ELECTRIC ACTUATORS 2:39, 2:44
 ELECTRIC ACTUATORS FOR BALL VALVES 11:28
 ELECTRICAL & ACCESSORIES
 ACTUATOR ROD 8:43
 ALIGNMENT WIRE & ACCESSORIES 8:46
 ARC SUPPRESSOR 8:46
 AUXILIARY CONTACTS 1:27, 8:45
 BLOCKS 1:13
 CABLE 1:4, 1:6, 1:7, 1:8, 1:9
 COLLECTOR RING 8:46
 CONTACTORS 1:27
 CORD CONNECTORS 8:40
 DIAGNOSTIC EQUIPMENT 1:32, 1:33
 FUSES 1:30, 1:31, 8:41, 8:42
 HEATER 8:46
 HOUR METER 8:43
 IRE & VALVE LOCATOR 1:33
 LIGHTNING ARRESTOR 8:46

- LIMIT SWITCHES 8:43
- LUGS 1:13
- MICRO SWITCHES 8:43
- MOTORS & STATORS 8:38, 8:39, 8:40
- MULTIMETER 1:32
- OVERWATERING TIMERS 8:43
- PANEL METERS 8:43
- PERCENTAGE TIMER 8:43
- PRESSURE SWITCHES 8:43
- RECTIFIER 8:46
- RELAYS 1:26, 8:44
- SPLICE KITS & MATERIAL 1:10
- STRAIN RELIEF CORD CONNECTORS 1:12, 8:40
- STROBE LIGHTS 8:48
- SUPPRESSOR 8:46
- TAPE 1:14
- TIMERS 8:43
- TOGGLE SWITCHES 8:43
- TOWER DISCONNECT 8:43
- TRANSFORMERS 8:43
- VOLTAGE DETECTOR 1:32
- WIRE & CABLE 1:4, 1:6, 1:7, 1:8, 1:9
- WIRE CONNECTORS 1:10
- WIRE & VALVE LOCATOR 1:33
- ELECTROFUSION**
- BUTT FUSION KIT 3:36
- FITTINGS 3:34
- PIPE CLAMP SET 3:36
- WELDING MACHINE 3:36
- ELEVATION FORMULA 14:12**
- ELOFIT ELECTROFUSION WELDING MACHINE 3:36**
- EMITTER INSTALLATION TOOL 10:56**
- EMITTERS 10:10**
- BOWSMITH® EMITTERS 10:10
- NETAFIM™ ON-LINE DRIPPERS 10:11
- RAIN BIRD® EMITTERS 10:11
- SUBMATIC ORIFICE EMITTERS 10:11
- TORO® AG EMITTERS 10:11
- EMT CONDUIT 1:17**
- EMT COMPRESSION RAIN TITE FITTINGS 1:17
- END GAUGE ASSEMBLY 8:5**
- END GUN**
- BOOSTER PUMP 8:35
- CONTROL VALVE & ACCESSORIES 8:33, 8:34
- SPRINKLERS & NOZZLES 8:20, 8:21, 8:26, 8:27, 8:28, 8:29, 8:30
- END PLUG**
- TWIST LOCK 5:12
- END SPRAY 8:19**
- END TEE**
- BAND & LATCH - GALV. 5:37
- BAND & LATCH LATERAL LINE 5:29
- RING LOCK - ALUM. HP 5:20
- RING LOCK - ALUM. LP 5:17
- RING LOCK - ALUM. LP WITH VALVES 5:18
- TWIST LOCK 5:12
- EPOXY COATED**
- ARM FOR AV & PRV 4:47
- BOLTED REPAIR COUPLINGS 4:63, 4:64
- BOLT TITE FITTINGS 4:59, 4:60, 4:61, 4:62
- FILTERS 11:6, 11:13, 11:17, 11:24, 11:25
- IPS FITTINGS 4:40, 4:41, 4:42, 4:43, 4:44, 4:45, 4:46, 4:47, 4:48
- PIP FITTINGS 4:49, 4:50, 4:51, 4:52, 4:53, 4:54, 4:55
- STARTER COUPLERS 2:91
- VALVE STUB 5:49
- WEDGE-TITE® FITTINGS 4:59, 4:60, 4:61, 4:62
- Z-PIPE 2:92
- EQUIVALENTS 14:6, 14:7, 14:10, 14:11, 14:12, 14:13**
- ESP-LXME CONTROLLERS 9:40**
- ESP-ME MODULAR CONTROLLERS 9:39**
- ET MANAGER™ CONTROLLERS 9:41**
- EURODRIP® SEAMLESS DRIP TAPE 10:9**
- EVA TRANSLUCENT REINFORCED HOSE 3:6**
- EXCLUDER FILTER 8:6**
- EXHAUST PRIMERS 2:20**
- EXPANSION CHAMBER COVER 8:38**
- EXPANSION COUPLING 4:26**
- EXTRA LARGE UTILITY VALVE BOX 9:50, 9:51**
- EZ ARC™ 9:12**
- EZ-FLO CONTROL VALVES 9:37**
- EZ-FLO FERTIGATION SYSTEM 12:12, 12:13**
- EZ OUT TOOL 13:12**
- EZ SCREENS 8:6**
- EZ-TRENCH 10:12**
- F**
- FAKE ROCKS 9:52**
- FALCON® 6504 SERIES ROTOR 9:18**
- FAN-JET® 10:14**
- FAN-JET "PC" EMITTERS 10:10**
- FANSHOT™ HOSE NOZZLES 3:15**
- FAN SPRAY 8:19**
- FASTENERS 10:53**
- NURSERY FASTENERS 10:53
- NUTS & BOLTS 13:6, 13:7, 13:8, 13:9
- VINEYARD FASTENERS 10:53
- FEEDTUBE ASSEMBLIES & ACCESSORIES R5 10:20, 10:21**
- FEEDTUBE ASSEMBLIES D10, S10, R10, R2000 6:14**
- FEMALE ADAPTER**
- CAM LEVER 3:20, 3:21, 3:22, 3:23, 3:24
- COMPRESSION HDPE 3:39
- COMPRESSION UNIVERSAL 3:42
- INSERT 3:38
- POLYPROPYLENE HOSE BARB 3:25, 12:21
- PVC IPS FABRICATED 4:15
- PVC PIP FABRICATED 4:7
- PVC SCH. 40 4:24
- PVC SCH. 40 CLEAR 4:28
- PVC SCH. 40 UVR 4:27
- PVC SCH. 80 4:32
- FEMALE COUPLER**
- POLYPROPYLENE 12:18
- FERTILIZER SYSTEMS 12:5, 12:6, 12:12, 12:13**
- AGRI-INJECT 12:4, 12:5, 12:6
- AMIAD® 12:14
- CHEM-FEED® 12:14
- ERATH EARTH 12:13
- EZ-FLO 12:12, 12:13
- INJECT-O-METER 12:8, 12:9
- MAZZEI® 12:14
- WALCHEM 12:15
- FIBERGLASS BOLTED COUPLINGS 4:66**
- FIELD TEE**
- BAND & LATCH - ALUM. 5:29, 5:31
- BAND & LATCH - GALV. 5:38
- BAND & LATCH LATERAL LINE - ALUM. 5:31
- PVC SURFACE 5:5
- RING LOCK - ALUM. HP 5:20
- RING LOCK - ALUM LP 5:17
- RING LOCK - GALV. 5:25
- FIGURE 8 END CLOSURE 10:29**
- FILTERS 11:4-11:33**
- FILTERS (BY BRAND)**
- AMIAD® 11:5, 11:6, 11:7
- AQUA-DROP 8:6, 11:4
- BANJO 11:8, 11:9, 11:10
- BARTOS 11:26
- CLEMONS 8:7, 11:11, 11:29
- FRESNO 8:7, 11:11, 11:26
- JAIN 11:4, 11:12, 11:13, 11:14
- KURIYAMA 11:32
- LAKOS 11:22
- NETAFIM™ 11:15, 11:16, 11:17, 11:18, 11:19, 11:26
- PENTEK 2:18, 2:19, 11:20, 11:21
- SURE-FLO 11:30, 11:31, 11:32, 11:33
- TWISTICLEAN 11:22
- VU-FLOW 11:22, 11:23
- YARDNEY 2:18, 11:24, 11:25, 11:27, 11:29
- FILTERS (BY TYPE)**
- 19000 SERIES SCREEN FILTERS 11:17
- AGF MEDIA FILTER BATTERIES 11:18
- APOLLO™ DISC-KLEEN FILTERS 11:17
- AUTOMATIC 11:7, 11:16, 11:17, 11:18, 11:24, 11:25
- CARTRIDGE TYPE 2:18, 2:19, 11:20, 11:21
- CYCLONE SAND SEPARATOR 11:26
- DISC 11:5, 11:6, 11:15, 11:16, 11:17
- DROP FILTERS 11:4
- EXCLUDER FILTER 8:6
- EXTERNAL LINE FILTER 11:8
- FLANGED STEEL FILTER 11:13
- GALVANIZED HIGH FLOW 8:7, 11:11
- HOSE THREAD FILTERS 11:4
- HYDROCYCLONE SAND SEPARATORS 11:26
- INTAKE STRAINERS 11:30, 11:31, 11:32, 11:33
- LINE STRAINERS 11:8
- MANUAL DISC FILTERS 11:15
- MAXI-CLEAN 11:24
- MAXI-FLUSH 11:24
- MINI "T" LINE STRAINERS 11:10
- PIVOT DROP 8:6
- PIVOT, HIGH CAPACITY 8:7, 11:11
- PLASTIC DISC FILTERS 11:15
- PLASTIC FILTERS 11:5, 11:12
- PRESSURE FINE GALVANIZED FILTERS 11:11
- PVC VU-FLOW 11:22, 11:23
- SAND MEDIA 11:18, 11:24, 11:25
- SAND SEPARATORS 2:18, 11:26, 11:27
- SCREEN 8:7, 11:4, 11:5, 11:6, 11:7, 11:8, 11:9, 11:10, 11:11, 11:12, 11:13, 11:14, 11:17, 11:22, 11:23, 11:24
- SPIN CLEAN 11:12, 11:13, 11:14
- SUPER FLOW FILTER 11:4
- TECHFILTER® 11:15
- T LINE STRAINERS 11:8
- WHEEL MOVE 7:26, 7:27
- Y STRAINER 11:4, 11:5, 11:6, 11:9, 11:10, 11:12, 11:13, 11:14
- Y STRAINERS 11:9
- FINAL DRIVE WHEEL GEARBOX 8:37**
- FIRE HYDRANT ADAPTER 3:18**
- FITTINGS**
- ADS® PIPE 9:53
- BALL AND SOCKET 5:13, 5:14, 5:15, 5:16
- BAND & LATCH - ALUM 5:26, 5:27, 5:28, 5:29, 5:30, 5:31, 5:32, 5:33, 5:34
- BAND & LATCH - STEEL 5:35, 5:36, 5:37, 5:38, 5:39, 5:40
- BARBED, HOSE 3:17, 3:18, 3:21, 3:22, 3:23, 3:24, 3:25, 3:26, 3:27, 3:28, 3:29, 3:30
- BARBED, PIPE 3:37, 3:38, 3:45
- BOLTED COUPLINGS 2:60, 2:61, 4:63, 4:64, 4:65, 4:66, 4:67
- BOLT TITE 4:59, 4:60, 4:61, 4:62
- BUTT WELD 2:85
- CAM LEVER 3:20, 3:21, 3:22, 3:23, 3:24
- COMPRESSION 10:27, 10:28, 10:29
- COMPRESSION DRIP 10:27, 10:28, 10:29
- COMPRESSION IPS HDPE 3:39, 3:40, 3:41, 3:42
- COMPRESSION UNIVERSAL IPS HDPE 3:41, 3:42
- CONNECTOR FITTINGS 10:39
- CONNECTOR FITTINGS WITH GROMMETS 10:40
- DRAINAGE 9:53, 9:54
- DRILINE 17MM 10:39
- DROP & CONVERSION FITTINGS 8:14
- FLANGED 2:62, 2:63, 2:64
- FUSION IPS HDPE 3:33, 3:34, 3:35
- GALVANIZED FITTINGS 8:14
- GROOVED 2:71, 3:26, 3:43, 4:33, 4:35
- HOOK & LATCH 5:26, 5:27, 5:28, 5:29, 5:30, 5:31, 5:32, 5:33, 5:34, 5:35, 5:36, 5:37, 5:38, 5:39, 5:40
- HOSE THREAD & TRANSITION ADAPTERS 10:50
- INSERT 3:37, 3:38, 10:39
- IPS EPOXY FITTINGS 4:40, 4:41, 4:42, 4:43, 4:44, 4:45, 4:46, 4:47, 4:48
- LAYFLAT 3:37, 3:38
- MALLEABLE 2:65, 2:66, 2:67, 2:68, 2:69, 2:70
- MERCHANT 2:71
- MERCHANT COUPLER 8:15
- NIPPLES BLACK & GALV. 2:71, 2:72, 2:73
- NIPPLES POLYPROPYLENE 12:20
- NIPPLES PVC 4:27, 4:34, 4:35

- NIPPLES STAINLESS STEEL** 2:80
OUTLET ADAPTERS 8:8, 10:40
PIP EPOXY FITTINGS 4:49, 4:50, 4:51, 4:52, 4:53, 4:54, 4:55
PLASTIC FITTINGS 8:14
POLY BARBED & THREADED 10:39
POLYMATE® 3:43
POLYPROPYLENE 3:20, 3:21, 12:18, 12:19, 12:20, 12:21
POWER-LOC 10:30, 10:31, 10:32, 10:33, 10:34
PVC IPS FABRICATED GASKETED 4:17, 4:18, 4:19, 4:20
PVC IPS FABRICATED SOLVENT WELD 4:14, 4:15, 4:16, 4:17
PVC PIP FABRICATED GASKETED 4:11, 4:12, 4:13
PVC PIP FABRICATED SOLVENT WELD 4:6, 4:7, 4:8, 4:9, 4:10
PVC SCH. 40 4:21, 4:22, 4:23, 4:24, 4:25, 4:26
PVC SCH. 40 CLEAR 4:28
PVC SCH. 40 UVR 4:27
PVC SCH. 80 4:29, 4:30, 4:31, 4:32, 4:33
PVC SURFACE 5:5, 5:6
RING LOCK - ALUMINUM 5:17, 5:18, 5:19, 5:20, 5:21
RING LOCK - STEEL 5:21, 5:22, 5:23, 5:24, 5:25
SIDE ROLL 7:17, 7:18, 7:19, 7:21, 7:22, 7:23, 7:24, 7:25
SPIRAL BARBED 9:30
STAINLESS STEEL 2:74, 2:75, 2:76, 2:77, 2:78
SUCTION 2:82
SWAGE 2:70
TAPE-LOC 10:35, 10:36, 10:37
TECHLINE® 17MM FITTINGS 10:39
TWIST LOCK - ALUMINUM 5:12
TWIST-LOCK DRIP 10:38
WEDGE-TITE 2:61, 4:59, 4:60, 4:61, 4:62
WELD-ON 2:83, 2:84, 2:85, 2:86, 2:87, 2:88, 2:89, 2:90, 2:91
WHEEL MOVE 7:17, 7:18, 7:19, 7:20, 7:21, 7:22, 7:23, 7:24, 7:25
FLAGS 9:60, 13:22
FLANGE ADAPTER 6:33
FLANGED
 ADAPTER - AMRAD 7:17
 ADAPTER - DEMOUNTABLE 7:19, 7:24
 ADAPTER, EPOXY IPS 4:40
 ADAPTER, EPOXY PIP 4:49
 BAUER STYLE FITTINGS 5:15, 5:16
 BUTTERFLY LINE VALVE 2:43
 CHECK VALVE 2:51
 CHEMIGATION VALVES 2:51, 2:52
 DISCHARGE ADAPTERS 2:62, 2:63
 FITTINGS 2:64
 FOOT VALVES 2:53
 GASKET PIVOT PIPE 8:46
 GASKETS 2:41, 5:59, 5:63
 GATE VALVES 2:46
FLANGES
 ALUMINUM 2:83
 BLIND 2:79
 CARBON STEEL 2:40, 2:88
 CAST IRON 2:41
 IPS HDPE FUSION 3:34
 IPS VAN STONE 4:15
 PIP VAN STONE FLANGE 4:7
 PLATE 2:79
 PVC FLANGES 2:41
 PVC IPS 4:33
 PVC PIP 4:15
 PVC SCH. 80 4:33
 PVC VAN STONE 2:41
 SLIP-ON 2:79
 STAINLESS STEEL 2:40, 2:79
 THREADED 2:79
 WHEEL REINFORCING 8:54
FLAPPER DRAIN 7:20
FLASHLIGHT 13:16
FLAT DISCS 2:88
FLAT WASHER 13:8
FLEXIBLE DROP HOSE 8:12
FLEXIBLE NIPPLE 9:29
FLEXIBLE PVC HOSE 9:30
FLEXIBLE RISERS 9:29
FLEXOGEN® HOSE 3:4
FLEX WEIGHT 8:13
FLOATING PUMPS 2:4
FLOAT VALVES 2:57, 2:58, 2:59
FLOW CONVERSION FACTORS 14:10
FLOW-GUARD GALVANIZED SCREEN 11:11
FLOW METERS 2:23, 2:24
 BANJO 2:26
 DATA INDUSTRIAL 2:26
 MCCROMETER 2:23, 2:25
 MULTI-JET 2:27
 NETAFIM™ 2:27, 2:28, 2:29
 TEE TYPE PVC FLOW SENSORS 2:26
FLOW TUBES 2:25
F-LUENT PLASTIC IMPACTS 6:22
FLUSH KIT 8:6
FOGGERS 10:22
FOG NOZZLE 3:15
FOOD TRANSFER HOSE 3:14
FOOT VALVES 2:53
FORGED GARDEN HOE 13:11
FORMULAS 14:12, 14:13
FRACTIONS CONVERSIONS 14:12
FREEZE-CLIK® FREEZE SENSORS 9:47
FRICTION LOSS CHARACTERISTICS 14:14, 14:15, 14:16, 14:17
FRICTION LOSS FORMULA 14:12
FROST FREE HYDRANTS 2:47
FULL CIRCLE 8:20
 GUNS 6:23, 6:24, 6:25, 6:26, 6:27, 6:28, 6:29, 6:30, 6:31, 6:32
 IMPACT SPRINKLERS 6:15, 6:16, 6:21, 7:6, 8:20, 8:21, 8:26
 NELSON BIG GUN 6:23, 8:28
FUNNY PIPE 9:30
FURROW ARMS 8:10
FUSE HOLDERS 1:28, 1:29
FUSES
 BOLT-IN FUSES 8:42
 GLASS BODY FUSES 8:41
FUSES 1:30, 1:31, 8:41, 8:42
 BOLT-IN FUSES 1:31
 CCMR 1:30
 FLNR 1:30
 FLQ 1:30
 FLSR 1:31
 GLASS BODY FUSES 1:30
 JTD 1:31
FUSE SELCTION CHART 14:8
FUSIBLE DISCONNECT 2:6
FUSION IPS HDPE FITTINGS 3:33, 3:34, 3:35
FUSION MACHINES 3:36
G
GALVANIZED
 BAND & LATCH 2:42, 3:29, 5:34, 5:35, 5:36, 5:37, 5:38, 5:39, 5:40
 BUTTERFLY LINE VALVES 2:42, 2:43
 CHAIN 13:4
 CHECK VALVES 2:51
 CHEMIGATION VALVES 2:51, 2:52
 CONE SCREENS 11:29
 DROPS 8:11
 DROP WEIGHTS 8:13
 FILTERS 8:7, 11:11
 FITTINGS FLANGED 2:64
 FITTINGS - PIVOT DROP CONVERSION 8:14
 FURROW ARMS 8:10
 GOOSENECKS 8:10
 GUN CARTS 6:34
 HOSE BARBED 3:26, 3:29, 3:30, 7:20
 MALLEABLE 2:65, 2:66, 2:67, 2:68, 2:69, 2:70
 MERCHANT FITTINGS 2:71
 NIPPLES 2:72
 PIPE BARBED 3:45
 REPAIR SLEEVE 7:23
 RING LOCK 2:43, 5:23, 5:24, 5:25
 RISERS, SPRINKLER 6:20
 STARTER COUPLERS 2:90
 TURNBUCKLES 13:5
 TWIST LOCK 3:30
 VALVE OPENERS 5:41, 5:42, 5:43
 VALVE STUBS 5:47, 5:48
 WHEEL SIDE ROLL 7:22
 WHEELS PIVOT 8:50
 WIRE ROPE 13:4
GARDEN
 HOE 13:11
 HOSE 3:4
 HOSE NOZZLES 3:15
 HOSE THREAD FITTINGS 3:16, 3:17, 3:18, 3:19, 3:20
 VALVES 2:47, 3:16
GAS ENGINE PUMP 13:21
GASKET CROSS REFERENCE 5:67
GASKETED FITTINGS
 BAND & LATCH GALV. 3:30, 5:35, 5:36, 5:37, 5:38, 5:39, 5:40
 EPOXY IPS 4:40, 4:41, 4:42, 4:43, 4:44, 4:45, 4:46, 4:47, 4:48
 EPOXY PIP 4:49, 4:50, 4:51, 4:52, 4:53, 4:54, 4:55
 PVC IPS FABRICATED 4:17, 4:18, 4:19, 4:20
 PVC PIP FABRICATED 4:11, 4:12, 4:13
 PVC SURFACE 5:6
 RING LOCK GALV. 2:43, 5:23, 5:24, 5:25
GASKET LUBRICANT 4:38
GASKETS
 ALL TYPES 5:57, 5:58, 5:59, 5:60, 5:61, 5:62, 5:63, 5:64, 5:65, 5:66
 BULKHEAD FITTING 12:20
 COMPRESSION IPS 4:48
 COMPRESSION PIP 4:55
 FLANGE 2:41
 PIVOT PIPE 8:46
 SURFACE PVC 5:6
GATED PIPE 5:4, 5:5
GATES
 ALUMINUM 5:7
 DISTRIBUTING 5:55
 POLY SLIDE 5:4
 PVC 5:7
 SLIDE 5:54
 TOGGLE 5:54
GATE VALVES 2:46
GAUGES
 ACCESSORIES 2:16, 8:5, 10:55
 DRY 2:15, 9:22
 LIQUID FILLED 2:16, 8:5, 10:55
 TAP ASSEMBLY 6:13, 10:21
GEARBOX 8:37
GEAR CLAMP 3:46, 8:15
GEAR DRIVEN ROTORS
 HUNTER® ROTORS 9:19, 9:20, 9:21
 RAIN BIRD® ROTORS 9:17, 9:18
 SIGNATURE® GOLF ROTORS 9:22, 9:23
GENERAL PURPOSE AIR & WATER HOSE 3:6
GLASS BODY FUSES 1:30, 8:41
GLOBE VALVE 10:43
GLOVES 13:19
GLUE - PVC 4:36, 4:37
GOE NIPPLE
 PVC SCHEDULE 80 4:35
 STEEL 2:71
GOLF ROTORS 9:22, 9:23
GOOF PLUG 6:9, 10:52
GOOSENECKS 8:10
 PLASTIC GOOSENECKS 8:10
 TRUSS ROD HOSE SLING 8:10
GORILLA® 500PSI MULTIPURPOSE HOSE 3:7
GRATES 9:54
GROMMETS 8:8, 10:40
GROOVED
 COUPLING, STEEL 4:33
 KING COMBINATION NIPPLE 3:26

ONE END STEEL NIPPLE 2:71
 POLYMATE ADAPTER 3:43
 PVC SCH. 80 COUPLING ADAPTER 4:33
 PVC SCH. 80 NIPPLES 4:35
 GROUNDING ROD 1:8
 GS1 GEAR DRIVE SPRINKLER 9:58
 GUN ADAPTERS 6:33
 GUN CARTS & STANDS 6:34, 6:35, 6:36, 6:37
 GUNS - FULL & PART CIRCLE
 NELSON 6:23, 6:24, 6:25
 SIME 6:26, 6:27, 6:28, 6:30, 6:31, 6:32
 GUN STAND 6:34
 GUN STAND OPENER
 ALUMINUM 5:44
 GALVANIZED 5:42
 GUZZLER HAND SUCTION PUMP 9:59, 13:20

H

HACKSAW 4:39
 HAMMER 13:11, 13:18
 HAMMER UNION 2:70, 3:35
 HAND CABLE CUTTER 1:15
 HAND CLEANER 4:38
 HAND DIAPHRAGM PRIMERS 2:20
 HANDLE - VOE 5:45, 5:46
 HAND PUMPS 13:20
 HAND SAWS 4:39
 HAND SPRAYERS 13:20
 HAND TOOLS 13:13, 13:14, 13:15, 13:16, 13:17, 13:18
 6-IN-1 MULTI-TOOL 13:14
 BAR TOOLS 13:11, 13:18
 BROOM 13:11
 CABLE SAW 4:39
 DIAGONAL CUTTING PLIERS 13:15
 DRILL TAP AND HOLE SAW KITS 13:14
 FLASHLIGHT 13:16
 HAMMERS 13:11, 13:18
 HOE 13:11
 HOLE SAW KITS 13:14
 INSULATED SCREWDRIVER & NUT DRIVER SETS 13:13
 KEYHOLE SAW 13:16
 KNIVES 13:17
 LONG NOSE PLIERS 13:15
 MULTI-TOOL SCREW DRIVER 13:14
 NUT DRIVER SETS 13:13
 PLIERS 13:15, 13:18
 POCKET-LIGHT FLASHLIGHT 13:16
 PROBE 13:11
 PUMP PLIERS 13:15
 RAILROAD PICK 13:11
 RAKE 13:11
 RATCHETING WRENCH SET 13:14
 SAN ANGELO BAR 13:11
 SAWS 4:39
 SCREWDRIVER SETS 13:13, 13:18
 TAPE MEASURE 13:18
 UTILITY KNIFE 13:16, 13:17
 WIRE BRUSH 13:18
 WRECKING BAR 13:18
 WRENCHES 13:14, 13:18
 HANGERS 8:8
 HANNA INSTRUMENTS 12:16, 12:17
 HARVESTING, RAIN WATER 9:55, 9:56
 HDPE COMPRESSION FITTINGS 3:39, 3:40, 3:41, 3:42
 HDPE REPAIR CLAMP 3:44
 HEAD TRIMMER 13:12
 HEATER 8:46
 HEATER PACKS 2:5
 HEAT EXCHANGERS 2:30
 HEAT SHRINK TUBE 1:10
 HEX BOLT 13:7
 HEX BUSHING
 MALLEABLE 2:69
 POLYPROPYLENE 12:19
 PVC SCH. 40 4:25

PVC SCH. 80 4:32
 STAINLESS STEEL 2:77, 2:78
 HEX CAP SCREW 13:6, 13:7
 HEX NUT 13:8
 HIGH FLOW STEEL SCREEN FILTERS 11:13
 HIGH PRESSURE PUMP 7:13, 7:14, 7:15, 7:16
 HOE 13:11
 HOLD BANDS 5:11, 7:21
 ALUMINUM 5:11, 7:21
 STEEL 5:11, 7:21
 HOLE COVER SADDLES 2:24, 4:71
 HOLE CUTTER 5:4
 HOLE PLUGS 5:4
 HOLE SAWS 13:14
 HOLE SAW WITH ARBOR 8:8, 10:57
 HOOK CHAIN 13:4, 13:5
 HOOK & LATCH FITTINGS 2:42, 5:26, 5:27, 5:28, 5:29, 5:30, 5:31, 5:32, 5:33, 5:34, 5:35, 5:36, 5:37, 5:38, 5:39, 5:40
 HORIZON® 200PSI MULTIPURPOSE AIR & WATER HOSE 3:7
 HOSE
 BARBED BAND & LATCH - GALV. 5:40
 BARBED FITTINGS - ALUM. 3:27, 3:28
 BARBED FITTINGS - BAUER STYLE 5:16
 BARBED FITTINGS - CAM LEVER 3:20, 3:21, 3:22, 3:23, 3:24
 BARBED FITTINGS - PIVOT DROP 8:14
 BARBED FITTINGS - POLYPROPYLENE 3:25
 BARBED FITTINGS - PVC 3:37, 3:38
 BARBED FITTINGS - STEEL 2:88, 3:26, 3:29, 3:30
 BARBED RING LOCK FITTINGS - GALV. 3:29
 BOOT 3:7, 3:8, 8:49
 CLEAR VINYL TUBING 3:5
 COMMERCIAL / INDUSTRIAL HOSE 3:4
 CUTTERS 4:39, 10:57
 DISCHARGE HOSE 3:5, 3:6, 3:7, 3:8, 3:11, 3:12, 3:13, 3:14
 DRAG ADAPTER 8:17, 8:18, 8:23, 8:25
 DRAINAGE 9:53
 DROP 8:12
 EXTENSIONS FOR DROPS 8:11
 GARDEN 3:4
 HOSE BIBBS 2:47
 LAYFLAT 3:9, 3:10
 LAYFLAT WATER DISCHARGE HOSE 3:9
 MENDERS 3:17, 3:26
 MULTIPURPOSE 3:6, 3:7
 NOZZLES 3:15
 PETROLEUM 3:14
 POLYETHYLENE TUBING - FOOD GRADE 3:5
 SAVER 8:11
 SUCTION HOSE 3:11, 3:12, 3:13, 3:14
 THREAD BRASS ADAPTER 3:18, 3:19
 THREAD CAM LEAVER FITTINGS 3:20
 THREAD COUPLINGS 3:17, 3:18
 THREADED QUICK CONNECTORS 3:16, 10:49
 THREAD FILTERS 11:4
 THREAD NOZZLES 3:15
 THREAD SHUT-OFF 3:16, 10:49, 10:51
 THREAD TRANSITION ADAPTERS 10:50
 WASHER 10:50
 WHEEL MOVE 3:7, 7:20
 HOSE ASSEMBLIES 12:5
 HOSE BARB
 POLYPROPYLENE 12:21
 HOSE SAVER 8:11
 HOSE THREAD FILTERS 11:4
 HOTSHOT™ HOSE NOZZLES 3:15
 HOUR METER 8:43
 HUB HALF - WHEEL MOVE 7:22
 HYDRANTS
 ALFALFA VALVES 5:52, 5:53
 BRASS ADAPTER 3:18
 BRASS HOSE BIBBS 2:47
 FROST FREE 2:47
 HYDRAULIC
 MOVER PARTS 7:26, 7:27

MOVERS 7:17
 HYDROCYCLONE SAND SEPARATORS 11:26

I

I-20 ROTORS 9:21
 I-20 ULTRA ROTORS 9:21
 I-25 ROTORS 9:21
 I-40 ROTORS 9:21
 I-90 ROTORS 9:21
 IBV BRASS CONTROL VALVES 9:34
 ICE CUBE RELAY 1:26, 8:44
 I-CORE COMMERCIAL CONTROLLERS 9:43
 ICV INSTITUTIONAL CONTROL VALVES 9:34
 ID CONTROLLED POLYETHYLENE PLASTIC PIPE 3:31
 I-MINI-WOBBLER® 6:7
 IMPACT ROTORS MAXI-PAW™ 9:18
 IMPACT SPRINKLERS
 BEARING ASSEMBLY 8:26
 FULL CIRCLE 6:17
 IMPACT SPRINKLERS 6:17
 JAIN FULL CIRCLE 6:16, 7:6
 LR NELSON® BETA PART OR FULL CIRCLE 6:17
 NELSON FULL CIRCLE 6:16, 8:26, 9:25
 NELSON PART OR FULL CIRCLE 6:17, 8:26, 9:25
 NOZZLES & ACCESSORIES 6:18, 6:19, 8:21
 RAIN BIRD® FULL CIRCLE 6:15, 9:24
 RAIN BIRD® PART OR FULL CIRCLE 6:17, 9:24
 SENNINGER® 23" F-LUENT™ 6:22
 SENNINGER® FULL CIRCLE 6:21, 8:20
 SENNINGER® PART CIRCLE 6:22, 8:20
 SIME SPRINKLER GUNS 6:28, 6:30, 6:31, 6:32
 WADE RAIN FULL CIRCLE 6:16
 WEATHER-TEC FULL CIRCLE 6:16, 9:25
 WEATHER-TEC PART OR FULL CIRCLE 6:17, 9:25
 XCAD AQUA BURST® FULL CIRCLE 6:16, 9:26
 XCAD AQUA BURST® PART OR FULL CIRCLE 6:17, 9:26
 INCREASER
 ALUMINUM RING LOCK LOW PRESSURE 5:18
 PVC SURFACE 5:6
 INJECTION EQUIPMENT 12:4-12:21
 HOOKUP KIT 12:14
 INJECTORS 12:14
 METERING PUMP 12:14
 POLY TANKS 12:14
 VENTURI INJECTOR 12:14
 INJECTION SYSTEMS 12:5, 12:8, 12:9
 INLET ADAPTERS 6:8
 INLINE DRIP TUBING 10:6
 INLINE EMITTERLINE 10:7
 INSECTIGATOR 12:7
 INSERT & CONNECTOR FITTINGS 10:40
 INSERT FITTINGS 10:39
 INSERT FITTINGS - PVC 3:37, 3:38, 4:26
 INSERT - PVC PIP REPAIR 4:8
 INSERT - STEEL 3:45
 INSULATED
 BLOCKS 1:13
 NUT DRIVER SETS 13:13
 POUCHES FOR ROCKS 9:52
 SCREWDRIVER SETS 13:13
 INTAKE COUPLERS 2:82
 INTAKE STRAINERS 11:30, 11:31, 11:32, 11:33
 INVERTED NOSE GARDEN VALVE 2:47
 IPS
 BLACK & GALV. FITTINGS & NIPPLES 2:65, 2:66, 2:67, 2:68, 2:69, 2:70, 2:71, 2:72, 2:73
 BOLTED REPAIR COUPLINGS 2:60, 2:61, 4:63, 4:64, 4:65, 4:66, 4:67
 BUTT WELD FITTINGS 2:85
 CEMENTS, PRIMERS & ACCESSORIES 4:36, 4:37
 EPOXY FITTINGS 4:40, 4:41, 4:42, 4:43, 4:44, 4:45, 4:46, 4:47, 4:48
 FLEX HOSE 9:30
 HDPE COMPRESSION FITTINGS 3:39, 3:40, 3:41, 3:42

HDPE FUSION FITTINGS 3:33, 3:34, 3:35
 OD CONTROLLED POLYETHYLENE PLASTIC PIPE 3:32
 PATCH CLAMPS 4:69
 POLYETHYLENE PLASTIC PIPE 3:32
 PVC FABRICATED FITTINGS 4:14, 4:15, 4:16, 4:17, 4:18, 4:19, 4:20
 PVC PLASTIC IRRIGATION PIPE 4:4, 4:5
 PVC SCH. 40 4:21, 4:22, 4:23, 4:24, 4:25, 4:26
 PVC SCH. 40 CLEAR 4:28
 PVC SCH. 40 UVR 4:17
 PVC SCH. 80 4:29, 4:30, 4:31, 4:32, 4:33, 4:34, 4:35
 SERVICE SADDLES 2:81
 STAINLESS FITTINGS, FLANGES & NIPPLES 2:78, 2:80
 IPS HDPE COMPRESSION FITTINGS 3:40, 3:41, 3:42
 IPS HDPE MOLDED & FABRICATED FITTINGS 3:33, 3:34, 3:35
 IRON
 ALFALFA VALVES 5:52, 5:53
 IRONSIDES® HEAVY-DUTY LAYFLAT HOSE 3:9
 IRRIPOD 7:4, 7:5, 7:6
 I-WOB 8:17, 8:18

J

JAR TOP CONTROL VALVES 9:31
 JETSTAKE 10:23
 JUMBO VALVE BOX 9:50, 9:51

K

KEY
 4 WAY HOSE BIBB 13:12
 METER 13:12
 SPRINKLER 13:12
 KEYHOLE SAW 13:16
 KILL WIRE 1:5
 KING NIPPLES
 STEEL HOSE BARB 3:26
 STEEL PIPE BARBED 3:45
 KLEARON™ CLEAR VINYL TUBING 3:5
 KNIVES 13:17

L

LADY BUG TURBULENT FLOW EMITTERS 10:11
 LANDSCAPE DRIPLINE TUBING 10:6
 LANDSCAPE LIGHTING CABLE 1:9
 LANDSCAPE TOOLS
 4 WAY KEY 13:12
 BROOM 13:11
 CAPROCK IRRIGATION SHOVEL 13:10
 CONCRETE COME-A-LONG 13:12
 DRAIN SPADE 13:10
 EZ OUT TOOL 13:12
 GARDEN HOE 13:11
 HEAD TRIMMER 13:12
 HOE 13:11
 LANDSCAPE FABRIC 13:12
 METER KEY 13:12
 MORTAR HOE 13:11
 POST HOLE DIGGER 13:10
 PROBE 13:11
 RAILROAD PICK 13:11
 RAKE 13:11
 SAN ANGELO BAR 13:11
 SHOVEL 13:10
 SLEDGE HAMMERS 13:11
 SPRINKLER KEY 13:12
 TAMP TOOL 13:12
 TRENCH SHOVEL 13:10
 WHEELBARROW 13:12
 LANDSCAPE TOOLS 13:10, 13:11, 13:12
 LATERAL LINE CONE SCREENS 11:29
 LATERAL LINE FITTINGS

BAND & LATCH - ALUM. 5:28, 5:29, 5:30, 5:31
 BAND & LATCH - STEEL 5:36, 5:37, 5:38, 5:39
 BAND & LATCH STEEL 5:40
 LAYFLAT FITTINGS
 ALUMINUM 3:27, 3:28
 PVC INSERT 3:37, 3:38
 STEEL HOSE BARB FITTINGS 3:29, 3:30
 LAYFLAT HOSE
 TAPE-LOC® FITTINGS 10:35, 10:36, 10:37
 LAYFLAT TOOLS 10:56
 LAYFLAT WATER DISCHARGE HOSE 3:10
 LENGTH CONVERSION FACTORS 14:10
 LEPA
 HD HOSE DRAG ADAPTER 8:23
 HOSE DRAG ADAPTER 8:18
 LEPA QUAD-SPRAY 8:17
 LEVELERS - WHEEL MOVE 7:21
 LEVEL HEAD RAKE 13:11
 LEVER LOAD BINDER 13:5
 LF SERIES PLASTIC IMPACTS 6:15
 LIGHTNING ARRESTOR 8:46
 LIMIT SWITCHES 8:43
 LINE / FIELD TEE
 RING LOCK 5:17
 LINE REDUCERS
 BAND & LATCH 5:29, 5:39
 PVC SURFACE 5:6
 RING LOCK 5:18
 RING LOCK - GALV. 5:25
 LINE STRAINERS 11:8
 LINE TEE
 BAND & LATCH 5:29, 5:31, 5:38
 PVC SURFACE 5:5
 RING LOCK - ALUM. HP 5:20
 RING LOCK - ALUM. LP 5:17
 RING LOCK - GALV. 5:25
 TWIST LOCK 5:12
 TWIST LOCK 5:12
 LIQUID FILLED PRESSURE GAUGE 2:16, 8:5, 10:55
 LOAD BINDERS 13:5
 LOCK NUTS 3:47, 13:8
 LOCK ON GAUGE CHUCK 2:16, 8:5, 10:55
 LOCK WASHER 13:9
 LONG NOSE PLIERS 13:15
 LOW DRIFT NOZZLE 8:17, 8:18
 LOW VOLTAGE LANDSCAPE LIGHTING CABLE 1:9
 LOW VOLUME IRRIGATION 10:2-10:57
 LUBRICANTS 4:38
 LUG BOLTS & NUTS 8:38
 LUGS ELECTRICAL 1:13

M

MACH II TIRES 8:53
 MACHINE SCREWS - FLAT PHILLIPS 13:9
 MACHINE SCREWS - PAN PHILLIPS 13:9
 MAGNETIC COIL 2:5
 MAINLINE FITTINGS
 BAND & LATCH - ALUM. 5:26, 5:27
 BAND & LATCH - GALV. 5:35, 5:36, 5:37
 RING LOCK - ALUM. 5:19, 5:20, 5:21
 RING LOCK - GALV. 5:23, 5:24, 5:25
 MAINLINE PIPE CLAMP 8:8
 MALE ADAPTER
 CAM LEVER 3:20, 3:21, 3:22, 3:23, 3:24
 COMPRESSION DRIP 10:28
 COMPRESSION HDPE 3:39
 COMPRESSION PVC IPS 4:26
 COMPRESSION UNIVERSAL 3:42
 HOSE BARBED 3:25, 3:26
 INSERT 3:38
 PIPE BARB STEEL 3:45
 POLYMATE 3:43
 POLYPROPYLENE 12:18
 POLYPROPYLENE BARBED 3:25

POWER-LOC 10:31
 PVC IPS FABRICATED 4:15
 PVC PIP FABRICATED 4:8
 PVC SCH. 40 4:24
 PVC SCH. 40 CLEAR 4:28
 PVC SCH. 40 UVR 4:27
 PVC SCH. 80 4:32
 ROPE CAST BRONZE 2:17
 TAPE-LOC 10:35
 MALLEABLE FITTINGS 2:65, 2:66, 2:67, 2:68, 2:69, 2:70, 8:14
 MANIFOLD
 POLYPROPYLENE 12:20
 MANIFOLD PRIMER 2:21
 MANIFOLD TEE - PVC SCH. 40 4:22
 MANUAL ANTI-SIPHON VALVE 9:48
 MANUAL DISC FILTERS 11:15
 MANUAL FLUSHING END PLUG 7:18, 7:25
 MARKING ACCESSORIES 9:60, 9:61, 13:22, 13:23
 BARRICADE TAPE 13:23
 FLAGS 13:22
 MARKING TAPE 13:23
 PAINT 13:22
 TAPE 13:22
 MARKING FLAGS 13:22
 MATCO BUTTERFLY VALVES 2:36
 MAX-94 CHEMIGATION CHECK VALVE 12:8
 MAXI-CLEAN 11:24
 MAXI-FLUSH 11:24
 MAXI-PAW™ 2045A 9:18
 MC-E® SERIES CONTROLLERS 9:45
 MEASURING TAPE 13:18
 MECHANICAL LUG CRIMPERS 1:15
 MEGANET™ 10:17
 MERCHANT FITTINGS
 STAINLESS STEEL 2:75, 2:76
 STEEL 2:71
 METER
 ELECTRICAL 1:24
 METER BASE HUB 1:17
 METER BASES 1:24
 METERING PUMP 12:14
 METER KEY 13:12
 METERS
 FLOW 2:23, 2:24
 MICRO-BIRD® II SPRINKLER 10:17
 MICRO DRIP TUBING 10:7
 MICRO IRRIGATION 10:2-10:57
 MICRO RAIN TRAVELERS 7:7, 7:8, 7:9, 7:10, 7:11, 7:12
 MICRO SPRINKLERS 10:13, 10:16, 10:17, 10:18, 10:19, 10:20, 10:21
 ANTELCO® ADJUSTABLE FLOW 10:13
 ANTELCO® DRIP MATE® KITS 10:12
 ANTELCO® MINI BUBBLER 10:13
 ANTELCO® ROTOR RAIN™ 10:17
 ANTELCO® ROTOR SPRAY™ 10:17
 ANTELCO® SHRUBBLER® 10:13
 ANTELCO® SPECTRUM 360™ 10:13
 ANTELCO® VERI-JETS™ 10:16
 BOWSMITH FAN-JET® 10:14, 10:15
 NELSON R5 ROTATOR 10:18, 10:19
 NELSON R5 ROTATOR® FEEDTUBE ASSEMBLIES & ACCESSORIES 10:20
 NETAFIM™ MEGANET™ 10:17
 NETAFIM™ SUPERNET JR 10:18
 OLSON O-JET® 10:16
 RAIN BIRD® MICRO-BIRD® II 10:17
 TORO® AG MICRO-SPRINKLER® VI CLASSIC 10:17
 MICRO-SPRINKLER® VI CLASSIC 10:17
 MICRO STROBE LIGHTS 8:48
 MICRO SWITCHES 8:43
 MICRO TUBING 10:5
 MILLIMETER CONVERSION 14:12
 MINI BUBBLER 10:13
 MINI-CLIK® RAIN SENSORS 9:46
 MINI MEDIA® SAND FILTERS 11:24

INTRO
 1. ELECTRICAL
 2. PUMP ACC.
 3. HOSE, PE PIPE & ACC.
 4. IPS, PIP PIPE & ACC.
 5. SURFACE
 6. SPRINKLERS
 7. TRAVELER & WHEEL MOVE
 8. PIVOT
 9. TURF
 10. LOW VOLUME
 11. FILTERS
 12. INJECTION
 13. HARDWARE
 INDEX

MINI PRESSURE REGULATORS & DRAIN CHECKS 10:25
 MINI-WOBBLER® 6:7
 MIRACLE PUNCH 10:56
 MISTER MIST'R 12:4
 MISTERS 10:22
 MISTING NOZZLE 10:22
 MOCK ROCKS 9:52
 MOISTURE TENSIO METERS 10:53
 MORTAR HOE 13:11
 MOTOR DROP CABLE 1:6
 MOTORS, CENTER DRIVE 8:38, 8:39, 8:40
 MOUNTED TIRES 8:50, 8:51, 8:52, 8:53
 MOVER ASSEMBLY 7:26, 7:27
 MOVERS WHEEL MOVE 7:17, 7:26, 7:27
 MPR40 & MPR POP UP SPRAYERS 9:7
 MP ROTATOR® 9:13, 9:14
 MULCH 9:57
 MULTI CONDUCTOR CABLE 1:5, 1:9
 MULTIMETER 1:32
 MULTIPARAMETER PORTABLE METERS 12:16
 MULTIPLE
 STEP REDUCER - PVC PIP 4:8
 TEE DRAINAGE 9:53
 MULTI PULSE STROBE LIGHT 8:48
 MULTI-PURPOSE AIR & WATER HOSE 3:6
 MULTIPURPOSE AIR & WATER HOSE 3:7
 MULTI TAP CONNECTIONS 1:13
 MULTI-TOOL 13:14
 MUSHROOM DRAINS
 CENTER PIVOT 8:6
 WHEEL MOVE 7:20

N

NAVIGATOR CONTROL GATE 5:56
 NDS TRI-FLO™ SPRAY STICK 10:23
 NETAFIM™ DRIP TAPE 10:8
 NETIRRIGATE® 8:47
 NIPPLE EXTRACTOR 13:12
 NIPPLES
 BLACK STEEL 2:71, 2:73
 GALVANIZED STEEL 2:72
 GROOVED PVC 4:35
 GROOVED STEEL 2:71
 HOSE THREAD & TRANSITION 10:50
 POLY CUT-OFF 9:29
 POLYETHYLENE SCH. 40 9:29
 POLYPROPYLENE 12:20
 PVC SCH. 80 4:34, 4:35
 PVC SCH. 80 UVR 4:27
 STAINLESS STEEL 2:80
 TOE 2:71, 4:34
 NMC-64 NETAFIM™ IRRIGATION CONTROLLER 10:48
 NODE CONTROLLERS 9:43
 NO KINK HOSE BIBB 2:47
 NONSTOP EMITTERS 10:10
 NO SPIN LUGS 8:54
 NOVAFLEX 2150 RUBBER WATER DISCHARGE HOSE 3:8
 NOZZLE CLIP 8:25
 NOZZLE FLOW FORMULA 14:12
 NOZZLES
 BRASS IMPACTS 6:18, 6:19, 8:21, 8:26
 CARRIER 8:16
 CLIP 8:25
 FOG 3:15, 10:22
 HOSE THREAD 3:15
 HUNTER® ADJUSTABLE 9:12
 HUNTER® MP ROTATOR® 9:13, 9:14
 NELSON 2TN 6:8
 NELSON 3TN 8:22, 8:23, 8:24
 NELSON BIG GUN® NOZZLES 6:24, 6:25, 8:29, 8:30
 NELSON BRASS IMPACTS 6:18, 8:26
 NELSON PIVOT 8:22, 8:23, 8:24
 RAIN BIRD® BRASS IMPACTS 6:18, 8:21, 9:24

RAIN BIRD® MPR 9:9
 RAIN BIRD® ROTARY 9:12
 RAIN BIRD® SHRUB ADAPTER 9:12
 RAIN BIRD® SPECIALTY 9:9
 RAIN BIRD® U-SERIES NOZZLES 9:10
 RAIN BIRD® VARIABLE ARC NOZZLES 9:10
 SENNINGER® IMPACT 6:21, 8:20
 SENNINGER® PIVOT 8:16, 8:18, 8:19
 TORO® PRECISION™ ROTATING 9:12
 TORO® PRECISION™ SERIES 9:11
 TORO VARIABLE ARC NOZZLES 9:11
 WOBBLER® 8:19
 XCAD AQUA BURST® 6:19
 NOZZLING, LABELING AND PACKAGING CHARGES 8:15
 NR3 PRESSURE REDUCING VALVE 9:47
 NURSERY FASTENERS 10:53
 NURSERY SPRAY STICKS 10:23, 10:24
 JAIN® (CHAPIN) 10:24
 NURSERY SPRINKLERS 6:6, 6:8
 NUT DRIVER SETS 13:13
 NUTRIFLO® FOOD TRANSFER SUCTION & DISCHARGE HOSE 3:14
 NUTRIFLO® SUCTION & DISCHARGE HOSE 3:14
 NUTS & BOLTS 13:6, 13:7, 13:8, 13:9
 ALL THREAD ROD 13:9
 CARRIAGE BOLTS 13:8
 FLAT WASHER 13:8
 HEX BOLT 13:7
 HEX CAP SCREW 13:6, 13:7
 HEX NUT 13:8
 LOCKNUT 13:8
 LOCK WASHER 13:9
 NYLON LOCKNUT 13:8
 REVERSIBLE LOCKNUT 13:8
 WEDGE ANCHOR 13:9
 NUTS & BOLTS SETS 2:39, 2:48, 13:9
 NYLON LOCK NUTS 3:47, 13:8

O

O3000 ORBITOR 8:23
 OCTAVE ULTRASONIC WATER METERS 2:29
 OD CONTROLLED POLYETHYLENE PLASTIC PIPE 3:32
 OETIKER CLAMPS & TOOLS 3:45, 8:15, 10:57
 OIL DRIPPER 2:22
 OIL SYSTEM 2:22
 OIL TANK & DRIPPERS 2:22
 O-JET® 10:16
 ONE WEIGHT 8:13
 ON-LINE DRIPPERS 10:11
 OPERATING COIL 2:7
 ORBIT MOTOR - WHEEL MOVE 7:26, 7:27
 ORBITOR 8:23
 O-RINGS 5:66, 7:25
 OUTLET ADAPTERS - DRIP 10:40
 OUTLET ADAPTERS - PIVOT 8:8
 OVERLOAD HEATER 8:46
 OVERLOAD RELAY 2:7
 OVERWATERING TIMERS 8:43

P

P-220 SERIES CONTROL VALVES 9:38
 PACKING - VOE 5:45, 5:46
 PAINT - MARKING 13:22
 PANEL
 CONTACTORS 1:27, 8:45
 METERS 8:43
 PART CIRCLE
 IMPACT SPRINKLERS 6:17, 6:22, 8:20, 8:21, 8:26
 ROTATORS 8:24
 SPINNERS 8:24
 SPRAYS - PIVOT 8:17, 8:24
 PART CIRCLE IMPACT SPRINKLERS 6:17, 8:20,

8:24

LR NELSON® 6:17
 NELSON 6:17, 8:26
 RAIN BIRD® 6:17, 8:21
 SENNINGER® 6:22, 8:20
 WEATHER-TEC 6:17
 XCAD 6:17
PARTS
 BAND & LATCH 5:34
 CLEARVIEW 2:50
 VALVE OPENING ELBOW 5:45, 5:46
 VALVE STUB REPAIR PARTS 5:50, 5:51
 PATCH CLAMPS 3:51, 3:50, 4:69, 4:70
 PC-D3000 PART CIRCLE SPRAYHEAD 8:24
 PC-R3000 PART CIRCLE ROTATOR 8:24
 PC-S3000 PART CIRCLE SPINNER 8:24
 PEB & PESB GLOBE VALVE 9:32
 PERCENTAGE TIMERS 8:43
 PETROLEUM HOSE 3:14
 PGA GLOBE / ANGLE VALVE 9:31
 PGJ ROTORS 9:20
 PGP-ATR ROTORS 9:20
 PGP ROTORS 9:20
 PGV PROFESSIONAL CONTROL VALVES 9:33
 PICK 13:11
 PIN AND BRACKET ASSEMBLY 8:38
 PINCERS 3:45, 10:57
 PINCH CLAMP & TOOLS 3:45, 8:15, 10:57
PIP
 BOLTED REPAIR COUPLINGS 4:63, 4:64, 4:65, 4:66, 4:67
 EPOXY FITTINGS 4:49, 4:50, 4:51, 4:52, 4:53, 4:54, 4:55
 PIPE REPAIR CLAMPS 4:68
 PVC FABRICATED FITTINGS 4:6-4:13
 PVC FABRICATED FITTINGS 4:6, 4:7, 4:8, 4:9, 4:10, 4:11, 4:12, 4:13
 PVC PLASTIC IRRIGATION 4:4
 PVC UV RESISTANT FITTINGS 4:10
PIPE
 ALUMINUM 5:9
 CUTTERS 4:39, 10:57
 DRAINAGE 9:53
 LAYFLAT 3:9, 3:10
 POLYETHYLENE ID CONTROLLED 3:31
 POLYETHYLENE OD CONTROLLED 3:32
 POLY LAYFLAT 5:4
 PVC CLEAR 4:28
 PVC GATED 5:5
 PVC IPS 4:4, 4:5
 PVC PIP 4:4
 PVC SURFACE 5:5
 PVC UV RESISTANT 8:8
 PVC WELL CASING & DROP PIPE 2:8
 REPAIR CLAMP 3:44, 4:69, 4:70, 4:71
 REPAIR CLAMPS 4:68
 THREAD SEALANT 4:38
 THREAD SEALANT 4:38
PIPE BARB 3:45
PIPE CUTTER 10:57
PIPE FITTINGS
 ADS 9:53
 PIPE GROMMETS 10:40
 PIPE LUBRICANT 4:38
 PITLESS ADAPTERS 2:8
 PITOT TUBE 2:16, 8:5, 10:55
PIVOT
 AQUADOCK™ 8:31
 BOOM BACKS 8:9
 BOOSTER PUMP 8:35
 BOOT HOSE 8:49
 CENTER DRIVES & MOTORS 8:38, 8:39, 8:40
 CONTROL VALVES 8:32, 8:33
 DRAGBULLET 8:12
 DRAIN VALVE 8:6
 DRIVE COMPONENTS 8:35
 DRIVELINE 8:35
 DRIVELINE COUPLERS 8:36

- DRIVE TRAIN COMPONENTS 8:35, 8:36, 8:37, 8:38, 8:39, 8:40
- DROP ACCESSORIES 8:6, 8:9, 8:10, 8:11, 8:12, 8:13, 8:14, 8:15
- DROP FILTERS 8:6
- DROPS 8:11
- DROP VALVES 8:6
- DROP WEIGHTS 8:13
- ELECTRICAL SUPPLIES 8:41, 8:42, 8:43, 8:44, 8:45
- END GUN BOOSTER PUMP 8:35
- END GUNS 8:27, 8:28
- FLUSHER 8:27
- FLUSH KIT 8:6
- FORMULAS 14:13
- FURROW ARMS 8:10
- GOOSENECKS 8:10
- HOSE SAVER 8:11
- IMPACT SPRINKLERS 8:20, 8:21
- MACH II 8:53
- MASTER IMPACTS 6:21, 8:20
- NELSON 3000 SERIES APPLICATORS 8:22, 8:23, 8:24, 8:25
- NELSON BIG GUN SPRINKLERS 6:23, 8:28
- NELSON IMPACT SPRINKLERS 8:26
- NELSON PURGE VALVE 8:26
- NELSON REGULATORS 8:25
- NO SPIN LUGS 8:54
- NOZZLING, LABELING CHANGES 8:15
- OUTLET ADAPTERS & ACCESSORIES 8:8
- PIPE GASKET 8:46
- POLYDROPS 8:11
- PRINTOUT 8:4, 8:15
- PRINTOUT DATA FORM 14:5
- RAIN BIRD® IMPACT 8:21
- REGULATORS 8:16
- SENNINGER® APPLICATORS 8:18, 8:19
- SENNINGER® IMPACT SPRINKLERS 8:20
- SENNINGER® UP3 PRODUCTS 8:16, 8:17
- SUPER FLUSH KIT 8:6
- SUPPORT HANGERS 8:8
- SYSTEM CABLE 1:6, 1:7
- TELESCOPING DRIVELINE WITH COUPLER ENDS 8:35
- TIRES 8:50, 8:51, 8:52
- UNDERSLING PVC PIPE & ACCESSORIES 8:8
- WHEEL GEARBOX 8:37
- WHEELS 8:50, 8:51, 8:52
- PIVOT SYSTEM CABLE 1:6, 1:7
- PLASTIC FILTERS 11:5, 11:12
- PLASTIC FITTINGS 8:14
- PLASTIC GOOSENECKS 8:10
- PLASTIC IMPACTS & NOZZLES 6:15, 6:16, 6:17, 6:18, 6:19, 6:21, 6:22, 8:20
- PLICORD® HD 4 PLY RUBBER WATER DISCHARGE HOSE 3:8
- PLICORD® SUCTION & DISCHARGE HOSE 3:14
- PLICORD® VERSIFLO™ 125PSI RUBBER WATER DISCHARGE HOSE 3:7
- PLIERS 13:15, 13:18
- PLUG
 - POLYPROPYLENE 12:20
- PLUG
 - BAND & LATCH - ALUM. 5:31
 - BAND & LATCH - DETACHABLE 5:29
 - BAND & LATCH - GALV. 5:39
 - CAM LEVER 3:21, 3:22, 3:23, 3:24
 - COMPRESSION - DRIP 10:29
 - DOUBLE LIP 5:4
 - DRAINAGE 9:53
 - EPOXY COATED IPS 4:48
 - EPOXY COATED PIP 4:55
 - HOSE THREAD 10:50
 - INSERT 3:38
 - MALLEABLE 2:70
 - MERCHANT 2:71
 - POLYPROPYLENE 12:20
 - POSITIVE LOCK 5:33
 - PVC SCH. 40 4:25
 - PVC SCH. 80 4:33
- PVC SURFACE 5:6
- RING LOCK - ALUM. HP 5:21
- RING LOCK - ALUM. LP 5:18
- RING LOCK - GALV. 5:25
- SINGLE LIP 5:4
- STAINLESS STEEL 2:78
- TWIST LOCK 5:12
- PLUMBERS TAPE 8:8
- POCKET-LIGHT FLASHLIGHT 13:16
- POCKET PRESSURE GAUGE 2:16, 8:5, 10:55
- POLYAIR® AIR & WATER HOSE 3:6
- POLYAIR® MULTI-PURPOSE AIR & WATER HOSE 3:6
- POLY BARBED & THREADED FITTINGS 10:39
- POLY CARBONATE BOX ENCLOSURES 1:24
- POLYDROPS 8:11
- POLYETHYLENE
 - SCH. 40 NIPPLE 9:29
- POLYETHYLENE PIPE
 - DRIP 10:4, 10:5, 10:6, 10:7
 - ID CONTROLLED 3:31
 - IPS OD CONTROLLED 3:32
- POLYETHYLENE PIPE FITTINGS
 - INSERT FITTINGS - PVC 3:37, 3:38
 - INSERT - STEEL 3:45
 - IPS HDPE COMPRESSION FITTINGS 3:39, 3:42
 - IPS HDPE FOR FUSION 3:33, 3:34, 3:35
 - POLYIMATE® 3:43
- POLYETHYLENE TUBING 10:4
- POLYETHYLENE TUBING - FOOD GRADE 3:5
- POLY LAYFLAT PIPE 5:4
- POLYIMATE ADAPTERS 3:43
- POLYPROPYLENE 11:8, 12:19, 12:20
 - BALL VALVES 2:45, 3:41, 3:42
 - CAM LEVER FITTINGS 3:20, 3:21, 12:18
 - FILTERS 11:8, 11:9, 11:10
 - HOSE BARB FITTINGS 3:25, 12:21
 - HOSE THREAD CAM LEVER FITTINGS 3:20
 - LINE STRAINERS 11:8
 - PIPE THREAD FITTINGS 12:19, 12:20
 - QUICK-ACTING FITTINGS 12:18
- POLY SLIDE GATE 5:4
- POLY TANKS 12:14
- POLYWEIGHT® GAUGE 8:5
- POLYWEIGHTS® 8:13
- POPPET DRAIN VALVE
 - CHEMIGATION 2:52
 - PIVOT 8:6
- POP-UP SPRAY HEADS
 - HUNTER® 9:6, 9:7
 - RAIN BIRD® 9:4, 9:5
 - TORO® 9:8
- PORTABLE METERS 12:16
- POST HOLE DIGGER 13:10
- POTS / PUMP STANDS 2:93
- POWER CONVERSION FACTORS 14:10
- POWER DISTRIBUTION BLOCKS 1:25
- POWER DISTRIBUTION CABLE 1:4
- POWER FORMULA 14:12
- POWER-LOC FITTINGS 10:30, 10:31, 10:32, 10:33, 10:34
- POWER RELAYS 1:26, 8:44
- POWER SAVER CENTER DRIVE 8:39
- POWER TRANSFORMERS 8:43
- PRECIPITATION RATE FORMULA 14:12
- PREMIUM DROP HOSE 8:12
- PREMIUM PLUS DROP HOSE 8:12
- PRESS-ON FITTINGS
 - BAND & LATCH - GALVANIZED 5:36, 5:37
 - BAND & LATCH LATERAL LINE - ALUMINUM 5:28, 5:29, 5:30
 - BAND & LATCH LATERAL LINE - STEEL 5:35, 5:36, 5:37, 5:38, 5:39, 5:40
 - BAND & LATCH MAINLINE - ALUMINUM 5:26, 5:27
 - BAND & LATCH MAINLINE - STEEL 5:35, 5:36, 5:37
 - BAND & LATCH SOLID SET - ALUMINUM 5:33
- POSITIVE LOCK 5:33
- REPAIR SLEEVE 5:11, 7:23
- RING LOCK ALUM. HIGH PRESS 5:19, 5:20
- RING LOCK ALUM. LOW PRESS. 5:17
- RING LOCK - GALVANIZED 5:23, 5:24, 5:25
- SOLID SET FITTINGS 5:33
- PRESSURE
 - COMPENSATING DRIP TUBING 10:5, 10:6
 - COMPENSATING EMITTERS 10:10, 10:11
 - GAUGES & ACCESSORIES 2:15, 2:16, 6:13, 8:5, 9:22, 10:21, 10:55
 - REDUCING VALVE NR3 9:47
 - RELIEF VALVES 2:15, 2:34, 2:35
 - SWITCHES 2:12, 8:43
 - VACUUM BREAKER 9:48, 9:49
- PRESSURE CONVERSION FACTORS 14:10
- PRESSURE FINE GALVANIZED FILTERS 11:11
- PRESSURE REGULATORS 6:4, 8:16, 8:25, 6:5, 10:25
- PRIMERS - PVC 4:36, 4:37
- PRIMING PUMPS 2:20
- PRINTED MARKING TAPE 9:60, 13:22
- PRINTOUT CHARGES 8:15
- PRINTOUT-PIVOT 8:4
- PROBE 13:11
- PRO-C CONTROLERS 9:42, 9:43
- PROFESSIONAL HAND TOOLS 13:13, 13:14, 13:15, 13:16
- PROOF POSITIVE® SPAN CABLE 1:6
- PROPORTIONAL INJECTION SYSTEM 12:6
- PRO-SPRAY SERIES POP UP SPRAYS 9:7
- PRS-DIAL 9:32
- PULL-UP TOOL, SPRAY HEAD 9:57
- PUMP
 - BOOST PUMPS 7:13, 7:14, 7:15, 7:16
 - CABLE 1:8
 - CONTROL PANELS 2:5, 2:6, 2:7
 - CONTROL RELAYS 1:26
 - CONTROL VALVE - CYCLE STOP 2:14
 - FLOATING PUMPS 2:4
 - PANELS 2:5, 2:6
 - PLIERS 13:15
 - PRIMING 2:20
 - STANDS 2:93
 - START RELAYS 2:12, 9:46
 - SUCTION SCREENS 11:29, 11:30, 11:31, 11:32, 11:33
 - TRANSFER PUMPS 13:21
 - WATER SUPPLY PUMPS 7:13, 7:14, 7:15, 7:16
- PUMP ACCESSORIES 8:2-8:55
- PUMP PLIERS 13:15
- PUMPS 2:4
- PUNCH TOOLS 6:9, 10:56
- PURGE VALVE 8:26
- PURGING SYSTEMS & ACCESSORIES 11:28
- PUSH BROOM 13:11
- PUSHBUTTON 2:5
- PUSH-IN FITTINGS & TUBING 8:34
- PVC
 - BALL VALVES 2:45
 - BOLTED REPAIR COUPLER 4:65, 4:66
 - BUTTERFLY LINE VALVES 2:43
 - BUTTERFLY VALVES 2:36, 2:37
 - CEMENTS, PRIMERS & ACCESSORIES 4:36, 4:37
 - CHECK VALVES 2:49
 - CONDUIT 1:16
 - DROP PIPE 2:8
 - DROPS 8:11
 - FILTERS - VU-FLOW 11:22, 11:23
 - FLANGES 4:7, 4:15, 4:33
 - FLAT JACKETED SUBMERSIBLE PUMP CABLE WITH GROUND 1:8
 - FLEX HOSE 9:30
 - GOOSENECKS 8:10
 - INSERT FITTINGS 3:37, 3:38
 - IPS FABRICATED GASKETED FITTINGS 4:17, 4:18, 4:19, 4:20
 - IPS FABRICATED SOLVENT WELD FITTINGS 4:14, 4:15, 4:16, 4:17
 - PIPE CLEAR 4:28

INTRO	1. ELECTRICAL	2. PUMP Acc.	3. HOSE, PE Pipe & Acc.	4. IPS, PIP Pipe & Acc.	5. SURFACE	6. SPRINKLERS	7. TRAVELER & WHEEL MOVE	8. PIVOT	9. TURF	10. Low Volume	11. FILTERS	12. INJECTION	13. HARDWARE	INDEX
-------	---------------	--------------	-------------------------	-------------------------	------------	---------------	--------------------------	----------	---------	----------------	-------------	---------------	--------------	-------

- PIPE EXTENSION SURFACE 5:6
 PIPE IPS 4:4, 4:5
 PIPE PIP 4:4
 PIPE SURFACE 5:5
 PIPE UV RESISTANT 8:8
 PIPE WELL CASING 2:8
 PIP FABRICATED GASKETED FITTINGS 4:11, 4:12, 4:13
 PIP FABRICATED SOLVENT WELD FITTINGS 4:6, 4:7, 4:8, 4:9, 4:10
 SCH. 40 CONDUIT & FITTINGS 1:16
 SCHEDULE 40 CLEAR 4:28
 SCHEDULE 40 FITTINGS 4:21, 4:22, 4:23, 4:24, 4:25, 4:26
 SCHEDULE 40 PIPE 4:5
 SCHEDULE 40 UVR 4:17, 4:27
 SCHEDULE 80 FITTINGS 4:29, 4:30, 4:31, 4:32, 4:33
 SCHEDULE 80 NIPPLES 4:34, 4:35
 SCHEDULE 80 PIPE 4:5
 SLOTTED WELL CASING 2:8
 SUCTION & DISCHARGE HOSE 3:12, 3:13, 3:14
 SURFACE FITTINGS 5:6
 SURFACE PIPE 5:5
 WATER HOSE 3:4
 WELL CASING PIPE 2:8
PVC INSERT FITTINGS 3:37, 3:38
PVC PIPE 2:8
PVC PIP & IPS PIPE & ACCESSORIES 4:2-4:71, 14:2-14:33
- Q**
- QUAD RINGS** 5:66
QUADRUPLEX ALUMINUM CABLE 1:4
QUARTZ SILICA SAND 11:28
QUICK-ACTING FITTINGS
 ALUMINUM 3:22
 GARDEN HOSE THREAD 3:20
 POLYPROPYLENE 3:21
 STAINLESS STEEL TYPE 304 3:23
 STAINLESS STEEL TYPE 316 3:24
QUICK CONNECT GAUGE FITTING 2:16, 8:5, 10:55
QUICK CONNECTORS 3:16, 10:49
QUICK COUPLING RISER VALVE 6:20
QUICK COUPLING VALVES & KEYS 9:27
QUICK DISCONNECT 6:33
- R**
- R5 ROTATOR*** 10:18, 10:19
R10 ROTATORS* 6:9
R10TG ROTATORS* 6:8
R10T ROTATORS* 6:9
R33 / R33LP ROTATOR* 6:12
R55A END GUN SPRINKLER 8:27
R2000CW COW WASH ROTATOR* 6:12
R2000 ROTATOR* 6:10
R2000WF WINDFIGHTER 6:11
R3000 ROTATOR 8:22
RAAFT TRACKS 8:55
RAILROAD PICK 13:11
RAIN BUG PRESSURE COMPENSATING EMITTERS 10:11
RAIN-CLIK™ RAIN SENSORS 9:47
RAIN DIAL CONTROLLER 9:45
RAIN SENSORS 9:46, 9:47
RAIN TITE CONNECTORS 1:17
RAIN WATER TANKS 9:55, 9:56
RAKE 13:11
RATCHETED LINE ANCHOR STABILIZER BAR 7:23
RATCHETING CABLE CUTTERS 1:15
RATCHETING WRENCH SET 13:14
RATCHET LOAD BINDER 13:5
RATCHET TIE DOWNS 13:19
RECTIFIER 8:46
- REDUCED PRESSURE ZONE ASSEMBLY** 9:48, 9:49
REDUCER
 BAND & LATCH - GALV. 5:39
 BAND & LATCH LATERAL LINE - ALUM. 5:29, 5:31
 BELL - MALLEABLE 2:68
 BELL - STAINLESS STEEL 2:76, 2:77
 BUSHING - MALLEABLE 2:69
 BUSHING - POLYPROPYLENE 12:19
 BUSHING - PVC SCH. 40 4:25
 BUSHING - PVC SCH. 80 4:32
 BUSHING - STAINLESS STEEL 2:77, 2:78
 BUTT WELD 2:85
 COUPLING - MALLEABLE 2:68
 COUPLING - POLYPROPYLENE 12:19
 COUPLING - PVC SCH. 40 4:24
 COUPLING - PVC SCH. 80 4:31
 COUPLING - STAINLESS STEEL 2:76, 2:77
 ELECTROFUSION 3:34
 EPOXY COATED IPS 4:47
 EPOXY COATED PIP 4:55
 FLANGED CONCENTRIC - GALV. 2:64
 MALLEABLE 2:68, 2:69
 NIPPLES 8:14, 12:20
 POLYPROPYLENE - BUSHING 12:19
 POLYPROPYLENE - COUPLING 12:19
 POLYPROPYLENE - NIPPLES 12:20
 PVC INSERT 3:38
 PVC IPS COUPLING 4:15
 PVC IPS FABRICATED 4:15, 4:19
 PVC IPS GASKETED 4:19
 PVC PIP COUPLING 4:8
 PVC PIP FABRICATED 4:8, 4:12, 4:13
 PVC PIP UV RESISTANT 4:10
 PVC SCH. 40 4:24, 4:25
 PVC SCH. 40 - CLEAR 4:28
 PVC SCH. 80 4:31, 4:32
 PVC SURFACE 5:6
 RING LOCK - ALUMINUM HP 5:21
 RING LOCK - ALUMINUM LP 5:18
 RING LOCK - GALV. 5:25
REDUCER BUSHING
 POLYPROPYLENE 12:19
REDUCER NIPPLES
 POLYPROPYLENE 12:20
REDUCING
 COUPLER DRAINAGE 9:53
 EPOXY COATED IPS TEE 4:42
 HDPE IPS COMPRESSION FITTINGS 3:39
 MALLEABLE 90 ELBOW 2:67
 MALLEABLE TEE 2:65
 POLYPROPYLENE - FITTINGS 12:19
 PVC INSERT FITTINGS 3:37, 3:38
 PVC IPS COUPLING 4:15
 PVC PIP COUPLING 4:8
 PVC SCH. 40 ADAPTERS 4:24
 PVC SCH. 40 - CLEAR FITTINGS 4:28
 PVC SCH. 40 FITTINGS 4:21, 4:22, 4:23, 4:24, 4:25
 PVC SCH. 40 - UVR FITTINGS 4:27
 PVC SCH. 80 FITTINGS 4:29, 4:30, 4:31, 4:32
- REGULATORS** 6:4, 8:16, 8:25, 6:5, 10:25
 3000 SERIES BLUE TOP 8:25
REINFORCED DROP HOSE 8:12
REINFORCING WHEEL FLANGE 8:54
RELAYS 1:26, 8:44
RELIEF VALVES 2:15
REMOTE CONTROL SYSTEM
 ROAM 9:43
REMOTE PANEL TRAY CABLE 1:7
REPAIR
 COUPLER, BOLTED 4:63, 4:64, 4:65, 4:66
 COUPLER EPOXY IPS 4:40
 COUPLER EPOXY PIP 4:49
 COUPLER, PVC IPS GASKETED 4:18
 COUPLER, PVC PIP FABRICATED 4:12
 COUPLER PVC SURFACE 5:5
 INSERTS PIP 4:8
 PIPE REPAIR CLAMP 3:44, 4:68, 4:69, 4:70, 4:71
 SLEEVES, PRESS ON STEEL 5:11, 7:23
- SPLICE** 3:28
REPAIR CLAMP 3:44
REVERSIBLE LOCK NUT 13:8
RIM - WHEEL MOVE 7:22
RING LOCK
 ALUMINUM - HIGH PRESSURE FITTINGS 5:19, 5:20, 5:21
 ALUMINUM HOSE BARBS 3:27
 ALUMINUM LOW PRESSURE FITTINGS 5:17, 5:18
 BUTTERFLY LINE VALVES 2:43
 CLAMPS 5:21
 GALVANIZED FITTINGS 5:22, 5:23, 5:24, 5:25
 HOSE BARBS - GALV. 3:29
 VALVE OPENERS 5:41, 5:42, 5:43, 5:44
RING-TITE GATE VALVE 2:46
RISER
 CAP, EPOXY IPS 4:46
 CAP, EPOXY PIP 4:54
 COUPLER, BOLT TITE 4:60
 ELBOW - WHEEL MOVE 7:21
 EXTENSION 9:29
 POLY RISERS & ACCESSORIES 5:46
 RAINWAY GROMMET ASSEMBLY 5:31
 SPRINKLER TURF 9:29
 TEE, EPOXY IPS 4:44, 4:45
 TEE, EPOXY PIP 4:52, 4:53
 TEE, PVC IPS 4:19
 TEE, PVC PIP 4:8
 TUBING 10:52
RISER CONNECTORS 10:38
RISERENCH 5:46
RISERS
 SPRINKLER RISERS 6:20
RISER STAKES 10:52
RISER TUBING 10:52
ROAD GUARDS 6:13, 6:19
ROAM REMOTE CONTROL SYSTEM 9:43
ROCK 11:28
ROCK COVERS 9:52
ROLLER APPLICATOR 4:37
ROLLER CHAIN 7:26, 7:27
ROLL PIN - VOE 5:45
ROPE 2:17
ROPE ADAPTERS 2:17
ROPE, BRADED SUBMERSIBLE SAFETY 2:17
ROPE CLIPS 13:5
ROTARY NOZZLES 9:12, 9:13
ROTATORS
 ACCESSORIES 6:13
 COW WASH 6:12
 FEEDTUBE ASSEMBLIES 6:14
 LOW VOLUME 10:18, 10:19, 10:20
 MP TURF 9:13
 NURSERY SPRINKLERS 6:8
 PIVOT 8:22, 8:24
 R33 / R33LP 6:12
 SOLID SET 6:9, 6:10, 6:11
ROTOR RAIN™ 10:17
ROTOR SPRAY™ 10:17
ROTORS - TURF
 HUNTER* 9:19, 9:20, 9:21
 RAIN BIRD* 9:16, 9:17, 9:18
 SIGNATURE* 9:22, 9:23
ROTOR TOOLS 9:57
ROUGHNECK GATE™ 5:7
ROUND & ATRIUM GRATES DRAINAGE 9:54
ROUND HOLE STRAINER 11:32
ROUND POINT SHOVEL 13:10
ROUND VALVE BOXES 9:50, 9:51
RUBBER
 COUPLINGS 4:71
 DISCHARGE HOSE 3:7, 3:8
 GASKETS 5:57, 5:58, 5:59, 5:60, 5:61, 5:62, 5:63, 5:64, 5:65, 5:66
 MALLET 13:18
 SUCTION HOSE 3:14
 TAPE 1:14

S

- S10 SPINNERS 6:8
 S3000 SPINNER 8:22, 8:24
 SADDLE METER 2:23
SADDLES
 HOLE COVER 4:71
 ONE PIECE BONDABLE 10:40
 PVC BONDABLE 10:40
 SERVICE 2:81
 SNAP ON PVC SCH. 40 4:26
 STEEL BOLT-ON 4:56, 4:57, 4:58
SADDLE TEE
 PVC BONDABLE 8:8
 PVC IPS FABRICATED 4:16
 PVC PIP FABRICATED 4:9
 PVC SCH. 40 4:26
SAFETY ROPE 2:17
SAFETY SWITCH
 EATON / CUTLER-HAMMER 1:22
 SIEMENS 1:23
SAN ANGELO BAR 13:11
SAND FILTERS 11:24
SAND MEDIA 11:28
SAND MEDIA FILTERS 11:25
 304 STAINLESS STEEL SAND MEDIA FILTERS 11:25
 CARBON STEEL SAND MEDIA FILTERS 11:25
 EPOXY LINED CARBON STEEL MINI MEDIA* SAND FILTERS 11:24
SAND & ROCK FOR SAND MEDIA FILTRATION 11:28
SAND SEPARATORS 2:18, 11:26, 11:27
SAWS 4:39, 13:16
SCANAWAY PLASTIC FILTERS 11:5
SCANAWAY STEEL FILTERS 11:6
SCHEDULE 40
 BUTT WELD FITTINGS 2:85
 MALLEABLE FITTINGS 2:65, 2:66, 2:67, 2:68, 2:69, 2:70
 POLYETHYLENE NIPPLE 9:29
 PVC FITTINGS 4:21, 4:22, 4:23, 4:24, 4:25, 4:26
 PVC FITTINGS, CLEAR 4:28
 PVC FITTINGS, ULTRA VIOLET RESISTANT 4:27
 PVC NIPPLES UVR 4:27
 PVC PIPE 4:5
SCHEDULE 80
 GROOVED NIPPLES 4:35
 PVC FITTINGS 4:29, 4:30, 4:31, 4:32, 4:33
 PVC NIPPLES 4:34
 PVC NIPPLES 4:35
 PVC PIPE 4:5
SCHRADER VALVE 2:16, 8:5, 10:55
SCOOP SHOVEL 13:10
SCREEN FILTRATION 11:4, 11:5, 11:6, 11:7, 11:8, 11:9, 11:10, 11:11, 11:12, 11:13, 11:17, 11:22, 11:23, 11:29, 11:30, 11:31, 11:32, 11:33
SCREW DRIVE AND PULL UP TOOL 9:57
SCREWDRIVER 13:13, 13:18
 2 PIECE SET BIG HANDLE 13:18
 5 PIECE AND 7 PIECE SETS 13:13
 6-IN-1 MULTI-TOOL 13:14
 9 PIECE INSULATED SET 13:13
SCREWDRIVER & NUT DRIVER SETS 13:13
SCREWS
 MACHINE SCREWS - FLAT PHILLIPS 13:9
 MACHINE SCREWS - PAN PHILLIPS 13:9
 TAPPING SCREWS - FLAT PHILLIPS 13:9
 TAPPING SCREWS - PAN PHILLIPS 13:9
SEAL-TITE CONNECTORS & TUBING 1:19
SEDIMENTATION TANKS 11:26
SELECTOR SWITCH 2:5
SELF CLEANING PUMP SUCTION SCREEN 11:29
SERVICE
 SADDLES 2:81
 TEE, EPOXY IPS 4:43
 TEE, EPOXY PIP 4:51
 SF-50 BRICK RED LAYFLAT HOSE 3:10
 SHIELDED BURIED SIGNAL CABLE 1:7
 SHIELDED MOTOR DROP 1:6
 SHOVEL 13:10
 SHROUD 8:17
 SHRUB ADAPTERS 9:12, 10:51
 SHRUBBLER* 10:13
 SHUT-OFF VALVES 3:16, 8:6, 10:49, 10:51
SIDE ROLL
 FITTINGS 7:17, 7:18, 7:19, 7:20, 7:21, 7:22, 7:23, 7:24, 7:25
 HOSE 7:20
 MOVER PARTS 7:26, 7:27
 MOVERS 7:17, 7:26, 7:27
 SILCOCK ADAPTER 2:16, 8:5, 10:55
 SILVER BULLIT IRRIGATION SCREEN 11:29
 SINGLE CONDUCTOR WIRE 1:9
 SINGLE LIP HOLE PLUGS 5:4
 SINGLE RAIL MOVER ASSEMBLY 7:26
 SLED BASE 9:58
 SLEDGE HAMMERS 13:11, 13:18
 SLEEVE TYPE CONTROL VALVES 2:54
 SLIDE BAND - WHELL MOVE 7:21
 SLIDE GATE 5:54
 SLOTTED WELL CASING 2:8
 SMART CONTROLLERS (ET) 9:41
 SMOOTH DRIVE™ 6:6
 SNAP ON SADDLE 4:26
 SNAP TEE, DRAINAGE 9:53
 SOCK CLIPS 5:8
 SOCKET FUSION PLUG & SOCKETS 3:36
 SOCKS 5:8
 SOIL MOISTURE TENSIO METERS 10:53, 10:54
 SOLAR PANEL KIT 11:19
 SOLENOID, VALVE & PARTS 8:34, 9:32, 10:42
 AQUAMATIC 8:33, 8:34
 BERMAD 10:42
 HUNTER* 9:33, 9:34
 IRRITROL 9:35
 IRRITROL* 9:35, 9:36
 JOHN DEERE™ 9:36
 NELSON 2:54, 10:44
 NETAFIM™ 10:42
 NETAFIM™ 2:55, 8:32, 10:45
 PIVOT FULL CIRCLE 8:22
 RAIN BIRD* 9:31, 9:32, 10:43
 RAIN BIRD 9:32
 TORO* 10:43
 TORO* 9:37, 9:38
 XCAD 2:56
 SOLID SET FITTINGS 5:32, 5:33
 SOLID STATE OVERLOAD RELAY 2:7
 SOOW CABLE 1:5
 SPAN CABLE 1:6
 SPECTRUM 360™ 10:13
 SPIDER - WELD IN VOE 5:50
 SPIKE COUPLER 6:20
 SPIN CLEAN FILTERS 11:12, 11:13, 11:14
SPINNERS
 LOW VOLUME 10:17
 PIVOT FULL CIRCLE 8:22
 PIVOT PART CIRCLE 8:24
 SPIRAFLEX® LAYFLAT HOSE 3:10
 SPIRAFLEX® SUCTION & DISCHARGE HOSE 3:12
 SPIRAL BARBED FITTINGS 9:30
 SPIRAL DOUBLE BOLT CLAMPS 3:48
 SPLICE KITS 1:10
 SPLICE KITS - WIRE 1:10
SPLICERS
 HOSE MENDERS 3:17, 3:25, 3:26
 HOSE REPAIR ALUMINUM 3:28
 HOSE REPAIR STEEL 3:30
 INSERT FOR PE PIPE 3:38
 PE PIPE REPAIR STEEL 3:45
 POLYMATE 3:43
 SPLINED CENTER DRIVES & MOTORS 8:40
 SPOKES - WHEEL MOVE 7:22
 SPOT SPITTER* 10:23
SPRAYERS 13:20
SPRAY HEAD PULL-UP TOOL 9:57
SPRAYS
 HUNTER* 9:6, 9:7
 NURSERY 6:7, 6:8, 10:12, 10:13, 10:14, 10:15, 10:16, 10:17, 10:18, 10:19, 10:20, 10:21, 10:22, 10:23, 10:24
 PIVOT 8:16, 8:17, 8:18, 8:22, 8:24
 RAIN BIRD* 9:4, 9:5
 TORO* 9:8
SPRAY STAKES 10:23
SPRAY STICKS 10:23, 10:24
SPRING CHECK VALVES 2:10, 2:49
 BRASS 2:10
 PVC 2:49
SPRINKLER ASSEMBLY 9:58
SPRINKLER KEY 13:12
SPRINKLER RISERS 6:20
SPRINKLERS & ACCESSORIES 8:20
 AGRICULTURAL IMPACT 6:15, 6:16, 6:17, 6:18, 6:19, 6:20, 6:21, 6:22
 AGRICULTURAL ROTATORS 6:9, 6:10, 6:11, 6:12
 COW WASH ROTATOR 6:12
 GUNS 6:23, 6:24, 6:25, 6:26, 6:27, 6:28, 6:30, 6:31, 6:32, 8:28, 8:29, 8:30
 NELSON BIG GUN SPRINKLERS 6:23, 8:28
 PIVOT 8:16, 8:17, 8:18, 8:19, 8:20, 8:21, 8:22, 8:23, 8:24, 8:25, 8:26, 8:27
 RAIN BIRD* FULL CIRCLE IMPACT SPRINKLERS 8:21
 SENNINGER* FULL CIRCLE IMPACT SPRINKLERS 8:20
 SENNINGER* PLASTIC PART CIRCLE IMPACT SPRINKLERS 8:20
 TURF IMPACTS 9:24, 9:25, 9:26
 TURF ROTORS 9:16, 9:17, 9:18, 9:19, 9:20, 9:21, 9:22, 9:23
 TURF ROTORY NOZZLES 9:12, 9:13
 TURF SPRAYS 9:4, 9:5, 9:6, 9:7, 9:8, 9:9, 9:10, 9:11, 9:12, 9:13
SQUARE & ATRIUM GRATES DRAINAGE 9:54
SQUARE POINT SHOVEL 13:10
SQUARE THREAD GAUGE ADAPTER 8:5
SQUARE THREAD X HOSE BARB ADAPTER 8:25
SQUEEZE VALVE 2:42, 2:43
SRM ROTORS 9:20
STAINLESS STEEL
 BALL VALVES 2:44
 CAM LEVER FITTINGS 3:23, 3:24
 CLAMPS 3:46
 CONE SCREENS 11:29
 FILTER 11:8, 11:10, 11:14, 11:17, 11:25
 FLANGES 2:40
 GOOSENECKS 8:10
 NIPPLES 2:80
 PIPE THREAD FITTINGS 2:78, 2:80
 WIRE ROPE 13:4
STAINLESS STEEL FITTINGS 2:74
STAKE ANCHORS 10:52
STAKE ASSEMBLIES 10:52
STANDARD VALVE BOX 9:50, 9:51
STAR DRAIN 8:6
STARTER 2:7
STARTER COUPLERS 2:89, 2:90, 2:91
 BAND & LATCH - BLACK 2:89
 BAND & LATCH - GALV. 2:90, 5:39
 BLACK 2:89, 5:22
 BOLT TITE 4:62
 BOLT-TITE 2:91
 EPOXY 2:91, 4:62
 GALVANIZED 2:90, 5:22, 5:23
 RING LOCK - BLACK 2:89, 5:22
 RING LOCK - GALV. 2:90, 5:22, 5:23
 WEDGE-TITE* 2:91, 4:62
STARTER PUSHBUTTON 2:5
STATORS 8:39

INTRO
 1. ELECTRICAL
 2. PUMP ACC.
 3. HOSE, PE PIPE & ACC.
 4. IPS, PIP PIPE & ACC.
 5. SURFACE
 6. SPRINKLERS
 7. TRAVELER & WHEEL MOVE
 8. PIVOT
 9. TURF
 10. LOW VOLUME
 11. FILTERS
 12. INJECTION
 13. HARDWARE
 INDEX

STEEET TEE

PVC SCH. 80 4:29

STEEL

CHAIN AND WIRE ROPE 13:5
 DRIVELINE COUPLER 8:36
 FILTER 11:6, 11:11, 11:13, 11:17, 11:24, 11:25
 HOLD BANDS 7:21
 HOLD BANDS 5:11
 REPAIR SLEEVE 5:11
 RING LOCK FITTINGS 5:21
 SAND SEPARATORS 11:26, 11:27

STEEL FITTINGS

BLACK MALLEABLE 2:65, 2:66, 2:67, 2:68, 2:69, 2:70
 BLACK NIPPLES 2:71, 2:73
 BLACK STARTER COUPLERS 2:89
 BLACK WELD-ON 2:86, 2:87, 2:88, 2:89
 BOLTED COUPLINGS 2:60, 2:61, 4:63, 4:64, 4:65, 4:67
 BUTT WELD 2:85
 EPOXY COATED IPS 4:40, 4:42, 4:43, 4:44, 4:45, 4:46, 4:47, 4:48
 EPOXY COATED PIP 4:49, 4:50, 4:51, 4:52, 4:53, 4:54, 4:55
 FLANGES 2:40
 GALV. BAND & LATCH 5:34, 5:35, 5:36, 5:37, 5:38, 5:39, 5:40
 GALV. MALLEABLE 2:65, 2:66, 2:67, 2:68, 2:69, 2:70
 GALV. NIPPLES 2:72
 GALV. PRESS-ON 5:22, 5:23, 5:24, 5:25
 GALV. RING LOCK 5:21, 5:22, 5:23, 5:24, 5:25
 GAVL. REPAIR SLEEVE 5:11
 GROOVED 3:26, 4:33
 GROOVED NIPPLES 2:71
 HOLD BANDS 5:11, 7:21
 HOSE BARB 3:29
 HOSE BARBED 3:26, 3:30
 IPS EPOXY FITTINGS 4:41
 MERCHANT 2:71
 NIPPLES 2:71, 2:72, 2:73

STEEL HANDLE CABLE CUTTER 1:15

STEEL HOSE BARB FITTINGS 3:30

STEEL PIPE NIPPLES 2:71

STEM

SHANK YOKE - VOE 5:45, 5:46
 VALVE STUB 5:50, 5:51
 VALVE STUB 5:50, 5:51
 WITH SOLID YOKE - VOE 5:45, 5:46

STERLING CONTROLLER 9:44, 10:48

STRAINERS

INTAKE STRAINERS 11:30, 11:31, 11:32, 11:33
 POLYPROPYLENE 11:8, 11:9

STRAIN RELIEF CORD CONNECTORS 1:12, 8:40

STREAMLINE THINWALL DRIPPERLINE 10:8

STREAM SPLITTERS ROTATORS 6:13, 10:21

STREET ELBOW

HDPE 4:22
 MALLEABLE 2:66
 POLYPROPYLENE 12:19
 PVC SCH. 40 4:22, 4:23
 PVC SCH. 40 CLEAR 4:28
 PVC SCH. 40 UVR 4:27

STREET TEE

PVC SCH. 40 4:22
 PVC SCH. 80 4:30

STROBE LIGHTS 8:48

STUB VALVES

ALUMINUM 5:49
 EPOXY 5:49
 STEEL 5:47, 5:48, 5:49

SUBMATIC ORIFICE EMITTERS 10:11

SUBMERSIBLE PUMP CABLE 1:8

SUBMERSIBLE SAFETY ROPE 2:17

SUCTION

FITTINGS 2:82
 HOSE 3:11, 3:12, 3:13, 3:14
 SCREENS 11:29, 11:30, 11:31, 11:32, 11:33
 SUCTION & DISCHARGE HOSE 3:11, 3:12, 3:13, 3:14
 GOODYEAR 3:12, 3:14

KIDDE 3:11

KURIYAMA 3:12, 3:13, 3:14

TEXCEL 3:11

SUN-FLOW LAYFLAT HOSE 3:10

SUPER FLOW FILTER 11:4

SUPER FLUSH KIT 8:6

SUPER SPRAY* 6:6, 8:16

SUPPORT HANGERS 8:8

SUPPRESSOR 8:46

SURELINE* DROP HOSE 8:12

SURFACE FITTINGS, PVC 5:6

SURFACE GATES 5:7

SURFACE PIPE

ALUMINUM 5:9

POLY 5:4

PVC 5:5

SURGE PLUG 5:21

SURGE VALVES 5:10, 5:11

SWAB 4:37

SWAGE FITTING 2:70

SWAGE SLEEVES 8:8, 13:5

SWAGE TOOL 13:5

SWING CHECK VALVE 2:48

SWING JOINTS 9:28

SWING PIPE 9:30

SWISH STIK™ 10:23

SWITCHES 2:5, 8:43

LIMIT 8:43

MICRO 8:43

PRESSURE 8:43

TOGGLE 8:43

SWIVEL HOSE ELL 9:27

T

T253AA WATER DISCHARGE HOSE 3:7

T3000 TRASHBUSTER SPRAYHEAD 8:23

TAMP TOOL 13:12

TANK ACCESSORIES 2:15

TANK CROSSES 2:11

TAP ASSEMBLY 10:55

TAP BOLT 13:7

TAPE 13:22

BARRICADE 9:61, 13:23

DUCT & BUNDLING TAPE 1:14

ELECTRICAL VINYL INSULATION 1:14

MARKING 9:60, 13:22, 13:23

NURSERY TYE 10:53

PIPE WRAP TAPE 1:14

PLUMBERS 8:8

RUBBER MASTIC 1:14

SEALING & COATING 1:14

SPLICING & TERMINATING 1:14

TEFLON 4:38

UNDERGROUND WARNING 9:61, 13:23

VINYL INSULATION TAPE 1:14

TAPE-LOC* FITTINGS 10:35, 10:36, 10:37

TAPE MEASURE 13:18

TAPERED CENTER DRIVES & MOTORS 8:38, 8:39, 8:40

TAPER RINGS , 6:24, 8:29

TAPE - THINWALL DRIPPERLINE 10:8, 10:9

TAPPING SCREWS - FLAT PHILLIPS 13:9

TAPPING SCREWS - PAN PHILLIPS 13:9

T-BOLT CLAMPS 3:47, 8:49

TBOS-II™ SERIES BATTERY POWERED

CONTROLLER 9:41

TECHFILTER* 11:15

TECHLINE & CONNECTOR FITTINGS 10:39

TECHLINE* CV 11:15

TECHLINE* CV DRIPPERLINE 10:5

TECHNICAL RESOURCES 14:10, 14:11, 14:12, 14:13

TEE

ALUMINUM RING LOCK HIGH PRESSURE 5:20

ALUMINUM RING LOCK LOW PRESSURE 5:17,

5:18

BAND & LATCH - ALUMINUM 5:29

BAND & LATCH - A&M LATERAL LINE 5:29

BAND & LATCH A&M UNIVERSAL 5:26

BAND & LATCH - GALVANIZED 5:37, 5:38

BAND & LATCH RAINWAY UNIVERSAL 5:27

BAND & LATCH UNIVERSAL VALVE 5:26, 5:36, 5:37

BAUER STYLE 5:15

BLACK WELD-ON - STEEL 2:87

BOLT TITE 4:61

BUTT WELD 2:85

CENTER INLET WHELL MOVE 7:18

COMPRESSION, DRIP 10:28, 10:29

COMPRESSION, IPS HDPE 3:40

COMPRESSION, PVC 4:26

DISTRIBUTION, BARBED 10:51

DRAINAGE 9:53

ELECTROFUSION 3:34

END, A&M LATERAL LINE 5:29

END, BAND & LATCH - ALUMINUM 5:29, 5:31

END, BAND & LATCH - GALVANIZED 5:37

END, PVC SURFACE 5:5

END, RING LOCK - ALUMINUM 5:17

END, RING LOCK - GALVANIZED 5:25

EPOXY COATED IPS 4:42

EPOXY COATED PIP 4:51

EPOXY RISER W/ STUB VALVE - IPS 4:44, 4:45

EPOXY RISER W/ STUB VALVE - PIP 4:52, 4:53

FLANGED 2:64

HDPE IPS COMPRESSION 3:40

HDPE IPS FUSION 3:33, 3:35

HOSE BARBED - ALUMINUM 3:27

HOSE BARBED - POLYPROPYLENE 3:25

INSERT 10:39, 10:40

IPS EPOXY COATED 4:42

IPS RISER W/ STUB VALVE 4:44, 4:45

LINE, BAND & LATCH - ALUMINUM 5:31

LINE, BAND & LATCH ALUMINUM 5:29

LINE, BAND & LATCH - GALVANIZED 5:38

LINE, PVC SURFACE 5:5

LINE RING LOCK- ALUMINUM 5:20

LINE, RING LOCK - GALVANIZED 5:25

LINE, TWIST LOCK - ALUMINUM 5:12

MALLEABLE 2:65

PIP EPOXY COATED 4:51

PIP EPOXY RISER W/ STUB VALVE 4:52, 4:53

POLYMATE 3:43

POLYPROPYLENE 12:19

PVC IPS FABRICATED 4:16

PVC IPS FABRICATED GASKETED 4:20

PVC PIP FABRICATED 4:8, 4:9, 4:13

PVC PIP UV RESISTANT 4:10

PVC SCH. 40 4:21

PVC SCH. 40 CLEAR 4:28

PVC SCH. 40 UVR 4:27

PVC SCH. 80 4:29

PVC SURFACE 5:5

RING LOCK- ALUMINUM HP 5:20

RING LOCK - ALUMINUM LP 5:17

RING LOCK ALUMINUM LP 5:18

RING LOCK - GALVANIZED 5:25

RING LOCK - GALVANIZED UNIVERSAL 5:24, 5:25

RING LOCK UNIVERSAL VALVE 5:20, 5:24, 5:25

STAINLESS STEEL 2:74

STREET TEE, SCH. 40 4:22

SURFACE - GALVANIZED 5:25, 5:37, 5:38

SURFACE, PVC 5:5

TAPE-LOC*, DRIP 10:36

UNIVERSAL COMPRESSION 3:41, 3:42

WELD-ON - ALUMINUM 2:83

WELD-ON BUTT WELD 2:85

TEE-JET* MISTER 10:22

TEFLON TAPE 4:38

TELESCOPING

ADAPTER WHEEL MOVE 7:18, 7:25

DRIVELINE 8:35

REPAIR COUPLING, PVC IPS 4:19

TEMPERATURE CONVERSION 14:11

TENSIOMETERS 10:53

TERMINAL BLOCKS 1:25

TERMINAL BOXES 1:25

TERRY TOWELS 9:57
 TESTERS 12:16
 T-HANDLE INSTALLATION TOOLS 9:57, 10:56
 THERMOPLASTIC FOG HOSE NOZZLES 3:15
 THREADED FITTINGS 10:39
 THREAD SEALANT & PASTE 4:38
 TIE DOWNS 13:19
 TIGERFLEX SUCTION & DISCHARGE HOSE 3:12, 3:13
 TIME DELAY FUSE 1:30, 8:41
 TIME DELAY RELAY 1:26, 8:44
 TIMERS 8:43
 CONTROLLERS 9:39, 9:40, 9:41, 9:42, 9:43, 9:44, 9:45
 OVERWATERING 8:43
 PERCENTAGE 8:43
 TIRE & WHEEL 8:50, 8:51
 ACCESSORIES 8:52
 GALVANIZED WHEELS & ASSEMBLIES 8:50
 IMPORT NEW TIRES AND ASSEMBLIES 8:52
 MACH II TIRES 8:53
 NO SPIN LUGS 8:54
 RAAFT TRACKS 8:55
 REINFORCING FLANGE 8:54
 T LINE STRAINERS 11:8
 TMC-212 SERIES CONTROLLERS 9:44
 TOE NIPPLES
 ALUMINUM 2:84
 STEEL 2:71
 TOGGLE
 GATE 5:54
 SWITCHES 8:43
 TOGGLE SWITCHES 8:43
 TOOL BAGS 13:16
 TOOLS
 ADJUSTMENT TOOL 9:57
 CLAMP 3:45, 3:48
 CUTTING TOOLS AND SAWS 4:39
 DEBURRING TOOL 4:39
 DIGGING 13:10
 EMITTER INSTALLATION 10:56
 FLAT BLADE SCREW DRIVE AND PULL UP TOOL 9:57
 HAND 13:13, 13:14, 13:15, 13:16, 13:17, 13:18
 HOLD UP 9:57
 LANDSCAPE 13:10, 13:11, 13:12
 LAYFLAT 10:56
 MARKING 9:60, 13:22
 OETIKER 3:45
 PUNCH 10:56
 SPRAY HEAD PULL-UP TOOL 9:57
 SWAGE 13:5
 T HANDLE TOOL 9:57
 TOP HAT™ 10:14
 TORQUE
 ARRESTOR 2:17
 CLAMP 7:18
 COUPLER 7:17, 7:19, 7:24
 TORQUE ARRESTOR 2:17
 TOWABLE
 GEAR BOX 8:37
 HUB 8:38
 TOWELS 9:57
 TOWER
 CONTACTOR 1:27, 8:45
 DISCONNECT 8:43
 TOW PIN 8:38
 TPV SERIES CONTROL VALVES 9:37
 TRANSFER PUMPS 13:21
 TRANSFORMERS 8:43
 TRANSITION
 BOLTED REPAIR COUPLINGS 4:67
 HDPE FITTINGS 3:35
 TRANSITION ADAPTERS 10:50
 TRANSPORT CHAIN 13:4
 TRASHBUSTER SPRAYHEAD 8:23
 TRAVELERS 7:7, 7:8, 7:9, 7:10, 7:11, 7:12
 TRENCH SHOVEL 13:10

TRIAD 6:6
 TRU-FLO™ EMITTERS 10:10
 TRUSS ROD HOSE SLING 8:10
 T-SPRAY™ 6:6
 TUBES - TIRES 8:50, 8:51
 TUF-SKIN EXTENSIONS 2:38
 TUF-SKIN SERIES BUTTERFLY VALVES 2:37
 TURBINE DRIVE SPRINKLER GUNS 6:26, 6:27, 6:28
 TURBO-KEY® TURBULENT FLOW EMITTERS 10:11
 TURBO-SC® PLUS PRESSURE COMPENSATING EMITTERS 10:11
 TURBULENT FLOW EMITTERS 10:10, 10:11
 TURF IRRIGATION
 BUBBLERS 9:15
 CONTROLLERS 9:39, 9:40, 9:41, 9:42, 9:43, 9:44, 9:45
 CONTROL VALVES 9:31, 9:32, 9:33, 9:34, 9:35, 9:36, 9:37, 9:38
 GOLF ROTORS 9:22, 9:23
 IMPACT SPRINKLERS 9:24, 9:25, 9:26
 ROTORS 9:16, 9:17, 9:18, 9:19, 9:20, 9:21, 9:22, 9:23
 SPRAY HEADS 9:4, 9:5, 9:6, 9:7, 9:8
 TURNBUCKLE 13:5
 TWIN RAIL MOVER ASSEMBLY 7:27
 TWISTICLEAN FILTER 11:22
 TWIST LOCK FITTINGS - DRIP 10:38
 TWIST LOCK FITTINGS - SURFACE 3:30, 5:12
 TWO ARM SPINNERS 6:6
 TYPHOON THINWALL DRIPPERLINE 10:8

U

U-CLEVIS 5:34
 UF WIRE 1:5, 1:6, 1:7, 1:9
 U-JOINT 8:36
 ULTRA LITE® STROBE LIGHT 8:48
 ULTRAVIOLET RESISTANT
 PVC IPS FABRICATED 4:17
 PVC PIP FABRICATED 4:10
 PVC SCH. 40 4:27
 PVC SCH. 80 NIPPLE 4:27
 UNDERGROUND
 CABLE 1:4, 1:5, 1:6, 1:7, 1:8, 1:9
 PIPE, FITTINGS & ACCESSORIES 4:2-4:71
 WARNING TAPE 9:61, 13:23
 UNDERGROUND WARNING TAPE 9:61, 13:23
 UNDERSLING PVC PIPE & ACCESSORIES 8:8
 UNINSULATED BUTT SPLICE 1:10
 UNION
 MALLEABLE 2:69
 PVC SCH. 40 4:26
 PVC SCH. 80 4:33
 STAINLESS STEEL 2:78
 UNI-SPRAY™ 9:5
 UNIVERSAL
 CATCH 5:34
 DRIVELINE COUPLER 8:36
 HOOK 5:34
 UNIVERSAL VALVE TEE
 BAND & LATCH - ALUMINUM 5:26, 5:27
 BAND & LATCH - GALVANIZED 5:36, 5:37
 RING LOCK ALUMINUM 5:20
 RING LOCK GALVANIZED 5:24, 5:25
 UP3 PRODUCTS 8:16, 8:17
 I-WOB 8:17
 LOW DRIFT NOZZLE 8:17
 SUPER SPRAY 8:16
 XI-WOB 8:17
 U-SERIES NOZZLES 9:10
 UTILITY HAND PUMP 13:20
 UTILITY KNIFE 13:16, 13:17

V

VACUUM BREAKER 9:48, 9:49
 VALVE BOXES

ARMOR® 9:50
 DALLAS SPECIALTY 9:50
 NDS VALVE BOXES 9:51
 RAIN BIRD® VALVE BOXES 9:51
 VALVE IN TEE 5:18, 5:24, 5:25, 5:26, 5:27, 5:36, 5:37
 VALVE KEYS 9:27
 VALVE OPENER REPAIR PARTS 5:45, 5:46
 VALVE OPENERS 5:41, 5:42, 5:43, 5:44
 VALVE OPENING ELBOW
 BAND & LATCH - ALUMINUM 5:43, 5:44
 BAND & LATCH - EPOXY 5:43
 BAND & LATCH - GALVANIZED 5:41, 5:42, 5:43
 RING LOCK - EPOXY 5:43
 RING LOCK - GALVANIZED 5:41, 5:42, 5:43
 VALVE OPENING TEE
 BAND & LATCH - ALUMINUM 5:43, 5:44
 BAND & LATCH - EPOXY 5:43
 BAND & LATCH - GALVANIZED 5:41, 5:42, 5:43
 RING LOCK - EPOXY 5:43
 RING LOCK - GALVANIZED 5:41, 5:42, 5:43
 VALVE RISERS 5:46
 VALVES 2:34
 AIR 2:15
 AIR & VACUUM RELIEF VALVES 2:31, 2:32, 2:33
 ALFALFA 5:52, 5:53
 BALL 2:44, 2:45
 BARBED SHUT-OFF 10:51
 BENT NOSE 2:47
 BUTTERFLY LINE 2:42, 2:43
 BUTTERFLY VALVES 2:36, 2:37
 CAST IRON ALFALFA 5:52, 5:53
 CAST IRON GATE 2:46
 CHECK 2:10, 2:48, 2:49, 2:50, 2:51
 CHEMIGATION 2:51, 2:52
 CLEARVIEW CHECK 2:50, 2:51
 COMPACT MOTORIZED BALL 11:28
 CONTROL 8:32, 8:33, 9:31, 9:32, 9:33, 10:44
 CONTROL - AG 2:54, 2:55, 2:56
 CONTROL - TURF 9:31, 9:32, 9:33, 9:34, 9:35, 9:36, 9:37, 9:38
 CYCLE STOP 2:14
 DRAIN 2:15, 2:52, 7:20, 9:57
 DRAIN CHECK 6:4, 6:5
 END GUN CONTROL 8:33, 8:34
 FLOAT 2:57, 2:58
 FLUSH 2:44, 2:45, 8:6
 FOOT 2:53
 FROST FREE HYDRANTS 2:47
 GATE 2:46
 GATE VALVES 2:46
 HOSE BIBB & GARDEN 2:47
 HOSE THREAD SHUT-OFF 3:16, 10:49
 NR3 PRESSURE REDUCING 9:47
 PIVOT DROP 8:6
 PIVOT FLUSH 8:6
 PLASTIC BALL VALVE 2:45
 PRESSURE REDUCING 9:47
 PRESSURE RELIEF 2:15
 PRESSURE RELIEF VALVES 2:34, 2:35
 PUMP CONTROL 2:14
 QUICK COUPLING 6:20, 9:27
 SCHRADER 8:5
 SNIFTER 2:15
 SOLENOID 2:54, 2:55, 2:56, 8:33, 9:31, 8:32, 9:32, 9:33, 9:34, 9:35, 9:36, 9:37, 10:45
 SPRING CHECK VALVES 2:10
 SQUEEZE 2:42, 2:43
 STUB 5:47, 5:48, 5:49
 SURGE 5:10, 5:11
 WAFER CHECK 2:48
 VALVE STUB REPAIR PARTS 5:50, 5:51
 VALVE STUBS 5:47, 5:48, 5:49
 VANES 2:25
 VAN STONE FLANGE
 PVC PIP 4:7
 PVC SCH. 80 4:33
 VARIABLE FREQUENCY DRIVES 1:21
 VELOCITY 14:12
 CONVERSION FACTORS 14:10

INTRO
 1. ELECTRICAL
 2. PUMP ACC.
 3. HOSE, PE PIPE & ACC.
 4. IPS, PIP PIPE & ACC.
 5. SURFACE
 6. SPRINKLERS
 7. TRAVELER & WHEEL MOVE
 8. PIVOT
 9. TURF
 10. LOW VOLUME
 11. FILTERS
 12. INJECTION
 13. HARDWARE
 INDEX

FORMULA 14:12
VENTURI INJECTOR 12:14
VERI-JETS™ 10:16
VERSIFLO™ WATER DISCHARGE HOSE 3:7
VINE CURL 10:53
VINEYARD FASTENERS 10:53
VINEYARD TYES 10:53
VINYL ADAPTERS 8:8
VINYLFLOW® LAYFLAT HOSE 3:9
VINYL MASTIC 1:14
VINYL TAPE 1:14
VISIBILITY
MARKING FLAGS, TAPE, PAINT AND
ACCESSORIES 9:60, 9:61, 13:22, 13:23
STROBE LIGHTS 8:48
VOLTMETER 8:43
VOLUME
CONVERSION FACTORS 14:10
FORMULA 14:12
VU-FLOW FILTERS 11:22

W

WAFER BUTTERFLY VALVES 2:36, 2:37
WAFER CHECK VALVE 2:48
WARNING TAPE 9:61, 13:23
WASHER 10:50
STEEL 13:8, 13:9
VINYL HOSE 10:50
WATER
DISCHARGE HOSE 3:5, 3:6, 3:7, 3:8, 3:9, 3:10, 3:11,
3:12, 3:13
GARDEN HOSE 3:4
SUCTION HOSE 3:11, 3:12, 3:13
SUPPLY PUMPS 7:13, 7:14, 7:15, 7:16
WATER HOSE 3:4
WATERTITE® PLUGS & CONNECTORS 1:12
WEATHER HEADS 1:17
WEATHER SENSORS
HUNTER® 9:47
RAIN BIRD® 9:46
TORO® SENSORS 9:47
WEDGE ANCHOR 13:9
WEDGE-TITE
CHEMIGATION VALVES 2:51
FITTINGS 4:59, 4:60, 4:61, 4:62
WEDGE-TITE®
FITTINGS 4:62, 4:63, 4:64
GASKET 4:61
WEIGHT CONVERSION FACTORS 14:10
WEIGHT'S PIVOT 8:13
WELD-IN VANES 2:25
WELD-ON
BAND & LATCH - ALUM. 5:26, 5:27
BAND & LATCH GATED PIPE COUPLERS 5:27
BAND & LATCH LATERAL LINE COUPLER 5:30
BAND & LATCH MAINLINE COUPLERS ALUM.
5:26
BAND & LATCH QUICK LATCH - ALUM. 5:27, 5:30
BAND & LATCH STARTER COUPLER - GALV 5:39
RING LOCK - ALUM. HIGH PRESSURE 5:19, 5:20
RING LOCK - ALUM. LOW PRESSURE 5:17
RING LOCK - GALVANIZED 5:22, 5:23
RING LOCK - STEEL 5:22
TORQUE COUPLER 7:19
WELD-ON FITTINGS
ALUMINUM 2:83, 2:84
BAND & LATCH STARTER COUPLER 2:89
BAUER STYLE 5:14
BLACK STARTER COUPLERS 2:89
BLACK STEEL 2:86, 2:87, 2:88
BOLTED STARTER COUPLER SET 2:91
BOLT TITE 4:62
EPOXY STARTER COUPLERS 2:91
GALVANIZED STARTER COUPLERS 2:90
HOSE BARB 3:26, 3:28, 3:30
RAIN FOR RENT TYPE COUPLER 5:33
RING LOCK STARTER COUPLER 2:89

STARTER COUPLINGS - BLACK 2:89
STARTER COUPLINGS - EPOXY 2:91
STARTER COUPLINGS - GALVANIZED 2:90
STEEL BUTT WELD 2:85
TWIST LOCK 5:12
WEDGE-TITE® 4:62
WELD-ON STEEL 2:87
WELL
CAPS 2:9
CASING 2:8
SEALS 2:9
WHEEL
CLEATS 7:23
MOVE 7:22
SPOKES 7:22
WHEELBARROW 13:12
WHEEL GEARBOX 8:37
WHEEL MOVE 7:19, 7:20, 7:21, 7:22, 7:23, 7:24, 7:25,
7:26, 7:27
WHEELS
FLANGE, PIVOT 8:54
GEAR BOXES 8:37
PIVOT 8:50, 8:51, 8:52, 8:53
WHIZ HEAD® 6:6
WIND BRACES 7:23
WIND-CLIK® WIND SENSOR 9:47
WINDFIGHTER ROTATOR® 6:11
WIRE
ALIGNMENT 8:46
BRUSH 13:18
CLAMP 3:45
ROPE 13:4
ROPE CLIPS 13:5
WIRE BRUSH 13:18
WIRE & CABLE
18 AWG MULTI CONDUCTOR 1:9
ARMORED PERIMETER GUIDANCE CABLE 1:7
BARE COPPER GROUND WIRE 1:8
CABLE IN CONDUIT 1:4
CONNECTORS 1:10
COPPER TRAY CABLE 1:5
KILL WIRE 1:5
LANDSCAPE LIGHTING CABLE 1:9
LOW VOLTAGE LANDSCAPE LIGHTING CABLE
1:9
MOTOR DROP 1:6
MULTI CONDUCTOR 1:5, 1:9
PIVOT SYSTEM CABLE 1:6, 1:7
PROOF POSITIVE® SPAN CABLE 1:6
QUADRUPLEX ALUMINUM 1:4
REMOTE PANEL TRAY CABLE 1:7
SHIELDED BURIED SIGNAL CABLE 1:7
SHIELDED MOTOR DROP 1:6
SINGLE CONDUCTOR 1:9
SOOW CABLE 1:5
SPAN CABLE 1:6
SPLICE KITS 1:10
STRIPPERS 1:14
SUBMERSIBLE PUMP CABLE 1:8
UNDERGROUND FEEDER 1:5, 1:9
WIRE STRIPPERS 1:14
WIRE CONNECTORS 1:10
WIRE CRIMING TOOLS 1:15
WIRE CRIMPERS 1:14
WIRE CUTTERS 1:14
WIRELESS CONTROL SYSTEMS 9:43
WIRE ROPE 13:4
WIRE SPLICING SUPPLIES 1:10
HEAT SHRINK TUBE 1:10
UNINSULATED BUTT SPLICE 1:10
WIRE STAKE ANCHORS 10:52
WIRE STRIPPERS 1:14
WIRE TIES & TOOLS 10:41
WIRE & VALVE LOCATOR 1:33
WOBBLERS 6:7, 8:19
WOODPECKER PRESSURE COMPENSATING
JUNIOR DRIPPERS 10:11
WORM GEAR HOSE CLAMPS 3:46

WR2 WIRELESS RAIN OR RAIN/FREEZE
SENSOR 9:46
WRECKING BAR 13:18
WRENCHES 13:14, 13:18
WYE
DRAINAGE 9:53
HOSE THREAD SHUT-OFF 3:16, 10:49
PVC IPS FABRICATED 4:17
PVC PIP FABRICATED 4:10
PVC SCH. 40 4:26
PVC SCH. 40 CLEAR 4:28
PVC SCH. 80 4:31
RING LOCK ALUMINUM LOW PRESSURE 5:18
STRAINERS 11:5, 11:6, 11:9, 11:10, 11:12, 11:13, 11:14,
11:15
WYE SADDLE
PVC IPS FABRICATED 4:16
PVC PIP FABRICATED 4:10
WYE STRAINER 9:49

X

XCEL-WOBBLER® 6:7, 8:19
X-CORE 9:42
XERI-BUBBLER™ 10:13
XI-WOB 8:17, 8:19

Y

Y STRAINERS 11:5, 11:6, 11:9, 11:10, 11:12, 11:13,
11:14, 11:15

Z

ZAMAC POPPET DRAIN 8:6
Z-PIPE 2:92

INTRO	1. ELECTRICAL	2. PUMP ACC.	3. HOSE, PE PIPE & ACC.	4. IPS, PIP PIPE & ACC.	5. SURFACE	6. SPRINKLERS	7. TRAVELER & WHEEL MOVE	8. PIVOT	9. TURF	10. LOW VOLUME	11. FILTERS	12. INJECTION	13. HARDWARE	INDEX
-------	---------------	--------------	-------------------------	-------------------------	------------	---------------	--------------------------	----------	---------	----------------	-------------	---------------	--------------	-------



**We are your one stop source for
all your Irrigation needs.**



Eastern Irrigation Supply, Inc.

5328 NW State Road 45
Newberry, FL 32669-1089
Phone: 352-472-3323
Fax: 352-472-2830
Email: eis@irrigationdistributors.com



Equipment Supply Co., Inc.

2224 Marshall Street
Lubbock, TX 79415
Phone: 806-747-0004 800-900-9975
Fax: 806-747-2706
Email: escosales@irrigationdistributors.com

ESCO / DUMAS

416 Success Blvd.
Dumas, TX 79029
Phone: 806-935-0004 855-824-9461
Fax: 806-935-0008
Email: dumas@irrigationdistributors.com



SWISH Inc.

970 CR 351
Stephenville, TX 76401
Phone: 254-965-4505
Fax: 254-968-4075
SWISH@IrrigationDistributors.com

SWISH Inc. Southeast Warehouse

132 Porter Street
Senatobia, Ms 38668
Phone: 662-301-1190
Fax: 662-301-1192
SWISH_SE@IrrigationDistributors.com



WISH, Inc.

888 Ventura Street
Aurora, CO 80011
Phone: 303-364-0777
Fax: 303-364-5055
Email: wish_co@msn.com



WISH Nebraska, Inc.

730 C Street
Ulysses, NE 68669
Phone: 402-549-2181
Fax: 402-549-2183
Email: wishne@clarks.net



WISH NORTHWEST

303 Industrial Lane
Pocatello, ID 83201
Phone: 208-232-0644 888-642-0644
Fax: 208-232-0694
Email: wninc@qwestoffice.net

WISH NORTHWEST WASHINGTON

514 EAST 1ST AVE.
Kennewick, WA 99336
Phone: 509-582-7592 Fax: 509-582-7528
Email: wishnw1@clearwire.net